

OMRON

型 E6B2

旋转编码器

使用说明书

感谢您使用欧姆龙产品。以下主要记载安装和使用本产品过程中需注意事项。

使用本产品前，请仔细阅读本说明书，充分了解产品。

为了您的方便，请妥善保管好本说明书。

0999007-5 A1

© OMRON Corporation 2012 All Rights Reserved.

输出回路图

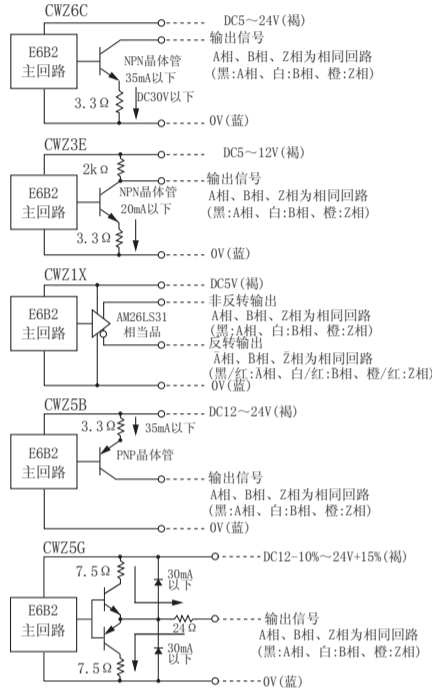

安全上的注意

●警告表示的意思

注意 如果不正确使用的话，有可能引起轻伤、中等程度的伤害还有可能带来同样重大的物质损害。

●警告表示

注意

通电状态下请勿拆开本产品。如触及内部会造成触电伤亡。

安全上的要点

- (1) 使用时请不要超过额定电压范围。如施加额定电压以上的电压时，会引起破裂和烧损。
(2) 高压线和动力线并行连线时，会因感应而发生误动作或破损，所以请分开连线。
(3) 使用电源如发生浪涌，请在电源间接上浪涌吸收器。为了避免干扰，请尽量在短距离之内连线。
(4) 在接通电源或切断电源时，容易发生错误脉冲，所以请在接通电源1秒后、及切断电源1秒前使用。
(5) 需注意电源极性，不能错误连线，以免引起破裂和烧损。
(6) 注意不能让负载短路，以免引起破裂和烧损。
(7) 请不要在可燃性、爆炸性的环境下进行使用。
(8) 请不要拆卸、修理、改造本产品。

正确使用方法

- (1) 旋转式编码器是由精密部件构成的，因此使用时要非常小心，不能跌落，以免损伤功能。
(2) 使用时请不要让水和油滴落在主体上。
(3) 连线时要在电源切断的状态下进行。电源ON时，输出线如接触电源，会引起输出回路破损。
(4) 固定本体、进行导线连线时，请注意导线的拉伸力度不要超过29.4N。
(5) 请勿往轴上施加过大的载荷，以免引起产品破损。用链条、传送带及齿轮连接时，先通过其他轴承，再用耦合器与编码器结合。
(6) 如果安装误差大（偏心、偏角），就会有过大的负载加在轴上，从而造成损坏或者缩短其使用年限。
(7) 当耦合器插入轴时，请不要用锤子敲击等增加冲击力。
(8) 安装、拆卸耦合器时，请勿进行不必要的弯曲、压缩和拉伸。

安装

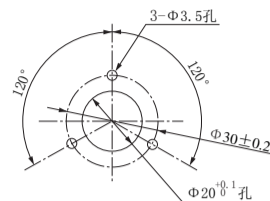

外形尺寸图

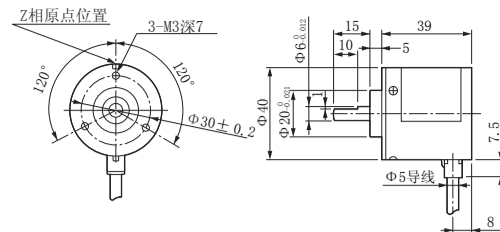

耦合器外形尺寸图

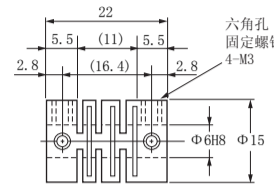

类型和规格

Table with 6 columns: Type, Power Voltage, Current Consumption, Output Status, Output Capacity, and Frequency. Rows include models E6B2-CWZ3E, CWZ6C, CWZ1X, CWZ5G, and CWZ5B.

接线

外部接线时，请注意不要错误连线。

Table mapping wire colors to terminal names for E6B2-CWZ6C, 3E, 5B, 5G models.

Table mapping wire colors to terminal names for E6B2-CWZ1X model.

使用时的承诺事项

- ① 为了确保安全，请勿将本产品直接或间接用于人体检测。
② 用于下列用途时，请与本公司营业担当商谈、并根据规格书等确认后，采用相对于额定性能留有一定余裕的使用方法或者采取即使出现故障也能使危险降低到最小的安全电路的对策。
a) 屋外使用、用于有潜在的化学污染或者有电气妨害时...
b) 用于原子能控制设备、焚烧设备、铁路·航空·车辆设备、医疗设备、娱乐器械、安全装置以及按照行政机关或个别业界规定制造的设备时...
c) 用于可能危及生命、财产的系统·机械·装置时...
d) 用于煤气、水道、电力供给系统或者24小时连续运转系统的高可靠性设备时...
e) 用于其他，以上述a)~d)为基准，需要高度安全性的用途时...
*上述内容是适用条件的一部分。请参阅本公司综合产品手册·数据等最新版商品目录、手册中记载的保证·免费事项内容后再使用。

■技术咨询
欧姆龙(中国)有限公司
地址：中国上海市浦东新区银城中路200号
中银大厦2211室
电话：(86) 21-5037-2222
技术咨询热线：400-820-4535
网址：http://www.fa.omron.com.cn

© 2011年3月

OMRON

Model E6B2

ROTARY ENCODER

INSTRUCTION SHEET

Thank for you selecting OMRON product. This sheet primarily describes precautions required in installing and operating the product.

Before operating the product, read the sheet thoroughly to acquire sufficient knowledge of the product. For your convenience, keep the sheet at your disposal.

TRACEABILITY INFORMATION:
Representative in EU: Omron Europe B.V.
Manufacturer: Omron Corporation, Shikokji Horikawa, Shimogyo-ku, Kyoto 600-8530 JAPAN

The following notice applies only to products that carry the CE mark:
Notice: This is a class A product. In residential areas it may cause radio interference, in which case the user may be required to take adequate measures to reduce interference.

© OMRON Corporation 2012 All Rights Reserved.

OUTPUT CIRCUIT DIAGRAM

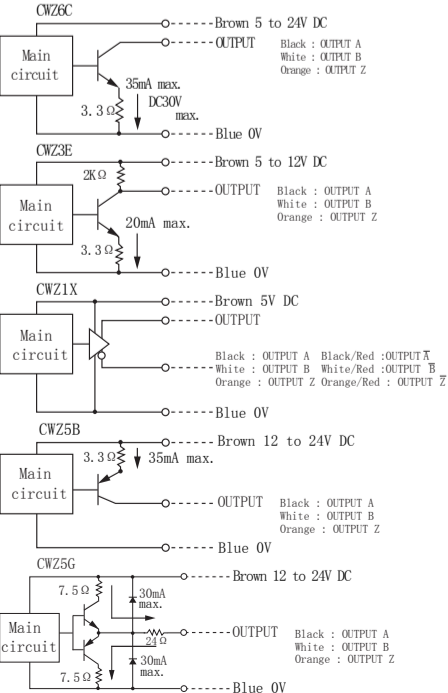

Precautions on safety

●Meaning of Signal Words

CAUTION Indicates a potentially hazardous situation which, if not avoided, may result in minor or moderate injury or in property damage.

●Alert statements

CAUTION

Do not attempt to take ant unit apart while the power is being supplied. Doing so may result in electric shock

Precautions for Safe Use

- 1) Do not use the product in excess of the rated voltage. Applying voltages beyond the rated voltage range may cause the product to breaker burn.
2) Avoid wiring the product's cables parallel to power lines or high-voltage lines. Doing so may cause the product to malfunction due to induction or may cause the damage product.
3) If surge occurs in the power supply, connect a surge absorber between the power supply terminals to absorb the surge. Minimize the wiring length to prevent the product from being affected by noise, etc.
4) Since improper pulses may occur when the power is turned on or off, use the devices connected to this product at least 1.0 seconds before or after the power is turned on or off.
5) Be careful when wiring, such as being careful with the polarities of the power supply. Incorrect wiring may break or burn the product.
6) Do not short-circuit the load. Doing so may break or burn the product.
7) Do not use the encoder under the environment with explosive or ignition gas.
8) NEVER disassemble, repair nor tamper with the product.

Precautions for Correct Use

- 1) Since the product consists of high-precision components, handle it with utmost care.
2) Be careful not to expose the product to water or oil.
3) Be sure to turn off the power supply before wiring. If the output line contacts the power supply line while the power is being supplied, the output circuit may be damaged.
4) If the product is mounted and wired with a cord, do not pull the cord with force greater than 29.4 N.
5) Be careful not to apply excessive load to the shaft. Excessive load may cause the product break. Especially when linking with a chain, timing belt, or gears, connect a separate bearing before the coupling to the product.
6) If an installation error such as misalignment is too large, (in case using the coupling or without coupling) the shaft will be subjected to an excessive load which will damage it or shorten its service life. Be careful when installing.
7) When inserting the shaft in the coupling, do not use excessive force (by striking it with hammer, for example).
8) When installing or removing the coupling, do not apply an excessive being, compressing, or tensile force.

MOUNTING

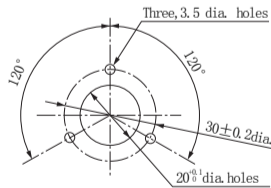

OUTLINE DRAWING

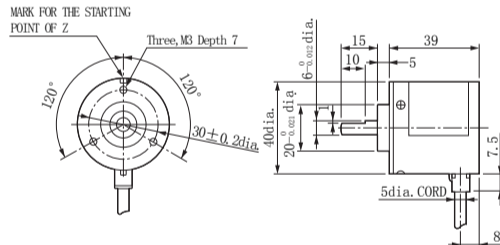

COUPLING

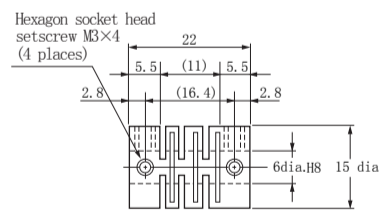

RATING

Table with 6 columns: Item, Type, and ratings for models E6B2-CWZ3E, CWZ6C, CWZ1X, CWZ5G, and CWZ5B.

Suitability for Use

THE PRODUCTS CONTAINED IN THIS SHEET ARE NOT SAFETY RATED. THEY ARE NOT DESIGNED OR RATED FOR ENSURING SAFETY OF PERSONS, AND SHOULD NOT BE RELIED UPON AS A SAFETY COMPONENT OR PROTECTIVE DEVICE FOR SUCH PURPOSES.

OMRON shall not be responsible for conformity with any standards, codes, or regulations that apply to the combination of the products in the customer's application or use of the product.

Take all necessary steps to determine the suitability of the product for the systems, machines, and equipment with which it will be used. Know and observe all prohibitions of use applicable to this product.

NEVER USE THE PRODUCTS FOR AN APPLICATION INVOLVING SERIOUS RISK TO LIFE OR PROPERTY WITHOUT ENSURING THAT THE SYSTEM AS A WHOLE HAS BEEN DESIGNED TO ADDRESS THE RISKS, AND THAT THE OMRON PRODUCT IS PROPERLY RATED AND INSTALLED FOR THE INTENDED USE WITHIN THE OVERALL EQUIPMENT OR SYSTEM.

See also Product catalog for Warranty and Limitation of Liability.

EUROPE: OMRON EUROPE B.V. Sensor Business Unit
NORTH AMERICA: OMRON ELECTRONICS LLC
ASIA-PACIFIC: OMRON ASIA PACIFIC PTE. LTD.
CHINA: OMRON(CHINA) CO. LTD.

© OCT, 2009