

# OMRON

## MODEL H5F

### DIGITAL DAILY TIME SWITCH

**English**

# INSTRUCTION MANUAL

Thank you for purchasing this OMRON product. This INSTRUCTION MANUAL describes the information such as function, performance, and how to use the product required for using the product.

- Please operate the product by the qualified specialist having the electrical know how.
- Read this instruction manual with enough, and use the product with enough understanding.
- Keep this instruction manual close at hand and use it for reference during operation.

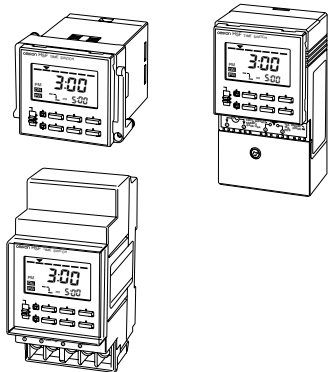

■ Safety Precautions	..... P1
■ Table of Contents	..... P5
■ Operation	..... P7
■ Installation	..... P29

OMRON Corporation

1617398-8D

© All Rights Reserved.

# Safety Precautions

## ● Key to Warning Symbols











Indicates information that, if not followed, could result in relatively serious or minor injury, property damage, or faulty operation.

## ● Graphic symbol

	<ul style="list-style-type: none"><li>● Warning against electric shocks Notification of possible electric shocks under certain conditions.</li></ul>
	<ul style="list-style-type: none"><li>● General warning Notification of general, unspecified prohibition items.</li></ul>
	<ul style="list-style-type: none"><li>● Prohibition against disassembly Notification of disassembly of products, when doing so can cause possible electric shocks.</li></ul>
	<ul style="list-style-type: none"><li>● General warning Notification of general, unspecified actions that users must perform.</li></ul>
	<ul style="list-style-type: none"><li>● Warning against rupture Notification of possible rupture under certain conditions.</li></ul>

## ● Precautionary Information

 <b>CAUTION</b>	
Do not touch any of the terminals while power is being supplied. Doing so may result in electric shock. Be sure to mount the terminal cover after wiring.	
Do not use the product where flammable or combustion gases are present. There may be a risk of explosion.	
Never disassemble, repair or modify the product. This may cause electric shock, fire or malfunction.	
Tighten the terminal screws securely. The recommended tightening torque is 8.67 in.lb. (0.98 N-m)[10.4 in.lb. max (1.17 N-m max)]. Loose screws may result in fire or malfunction.	
Before changing times or other settings while power is being supplied, either turn OFF the power on the load side or set the Out ON/OFF switch to OFF and confirm the safety of the system.	
The life expectancy of the output relay varies considerably according to its usage. Use the output relay within its rated load and electrical life expectancy. If using the Time Switch beyond its ratings is unavoidable, use it together with an electromagnetic switch or contactor in the way described on page 32. If the output relay is used beyond its life expectancy, its contacts may become fused or there may be a risk of fire.	
Never disassemble, deform, subject to heat over 100°C or dispose in fire. The product has a built-in lithium battery. Fire, Explosion and Burn Hazard.	

# Precautions for Safe Use

Please comply strictly with the following instructions which are intended to ensure safe operation of the controller.

- (1) Application of voltages other than the rated voltage may seriously damage the internal elements.
- (2) Separate the Time Switch from any potential sources of noise, such as high-voltage lines. When using inductive loads (e.g., electromagnetic relays), connect noise-absorbing elements (resistor and capacitor) to both ends of the coil.
- (3) Do not install the Time Switch close to sources of excessive static electricity (e.g., forming compounds, powders, or fluid materials being transported by pipe).
- (4) Locations subject to temperatures or humidity outside the range specified in the specifications.
- (5) Mounting the Time Switches side-by-side may reduce the life expectancies of internal components.
- (6) Do not use the Time Switch in environments subject to shocks or vibration beyond the ranges specified in this document.
- (7) Do not use the Time Switch in dusty environments, in locations where corrosive gases are present, or in locations subject to direct sunlight.
- (8) Store at the specified temperature. If the Time Switch has been stored at a temperature of less than  $-10^{\circ}\text{C}$ , allow the Time Switch to stand at room temperature for at least 3 hours before use.
- (9) This product is not waterproof or oil-proof. Do not use it in locations where water or oil may enter the product interior.
- (10) To prevent damage to the exterior of the Time Switch, it must not be exposed to organic solvents (e.g. Paint thinner or benzine), strong alkalis, or strong acids.
- (11) When using heaters, be sure to use a thermal switch for the load circuit.
- (12) Take adequate protective measures for the power supply of the Time Switch (such as providing a breaker and fuse).

## Precautions for Correct Use

- (1) Be sure to wire the terminals correctly.
- (2) Perform wiring using appropriate wires of the type specified in this document. Using a different type of wire may result in burn injury or fire due to abnormal heat generation.
- (3) Do not use the Time Switch in the following locations:
  - Locations where condensation may occur due to high humidity levels
  - Locations subject to extreme temperature variations
- (4) Do not leave the Time Switch for long periods (i.e., one month or longer) at a high temperature with output current in the ON state. Doing so may result in the premature deterioration of internal components (e.g., electrolytic capacitors).
- (5) Always maintain the power supply voltage within specifications.
- (6) Apply the full power supply voltage through the breaker, switch, and relay contacts simultaneously. Gradually increasing the voltage may result in malfunction.
- (7) When the power is turned ON, an inrush current will flow for a short time (approx. 2 A for 0.3 ms at 264 VAC). Depending on the power supply capacity, operation may not start. Be sure to use a power supply with a sufficient capacity and a breaker.
- (8) None of the Time Switch components are user-replaceable, including the battery.

## Suitability for Use

OMRON shall not be responsible for conformity with any standards, codes, or regulations that apply to the combination of the products in the customer's application or use of the product.

Take all necessary steps to determine the suitability of the product for the systems, machines, and equipment with which it will be used.

Know and observe all prohibitions of use applicable to this product.

**NEVER USE THE PRODUCTS FOR AN APPLICATION INVOLVING SERIOUS RISK TO LIFE OR PROPERTY WITHOUT ENSURING THAT THE SYSTEM AS A WHOLE HAS BEEN DESIGNED TO ADDRESS THE RISKS, AND THAT THE OMRON PRODUCT IS PROPERLY RATED AND INSTALLED FOR THE INTENDED USE WITHIN THE OVERALL EQUIPMENT OR SYSTEM.**

See also Product catalog for Warranty and Limitation of Liability.

# Table of Contents

Safety precautions	1
Precautionary information	2
Precautions for safe use	3
Suitability for use	4
Table of contents	5.6

## Operation

1. Nomenclature	7
2. Operating functions	8
3. Selecting the mode	9
4. Setting the time	10
5. Setting timer operation	11.12
6. Setting pulse-output operation	13.14
7. Setting partial operation on specified day	15.16
8. Changing (Confirming) settings	17.18
9. Clearing the settings	19.20
10. Setting (Temporary) Holidays	21
11. Summer time(DST)	22
12. Switching between 12-hour(am/pm) and 24-hour Display	22

13. Override and automatic return operation	23.24
14. Program check function	25
15. Operation while the power supply is OFF	26
16. Setting precautions	26
17. Setting examples	27
18. Troubleshooting	28



## **Installation**

1. Dimensions and mounting dimensions	23.24
2. Connections	31
3. Wiring	31.32
4. Output (built-in relay) life expectancy	33
5. Ratings and performance characteristics	33
6. EN/IEC standards	34
7. Record of settings	34



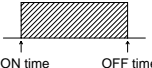
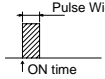
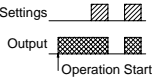
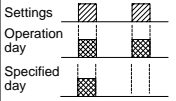

## 2. Operating Functions

Operating function	Explanation	Remarks
<b>Timer Operation (ON / OFF)</b> 	Output control is determined by the ON/OFF time settings. <ul style="list-style-type: none"> <li>• Minimum setting interval: 1 min</li> <li>• One ON/OFF set counts as two steps.</li> <li>• Up to 24 steps can be set.</li> </ul>	P.11
<b>Pulse-Output Operation</b> 	Output turns ON for a fixed period (pulse) at the set time. <ul style="list-style-type: none"> <li>• Pulse Width : 1 to 59s, 1 to 60 min</li> <li>• One pulse-output operation set counts as one step.</li> <li>• Up to 24 steps can be set.</li> </ul>	P.13
<b>Forced ON/OFF Operation</b>	Control output is continuously held in the ON state, regardless of the settings, using the Out ON/OFF switch.	—
<b>Override and automatic return operation</b> 	Using the Out ON/OFF switch and the Write Key, regardless of the settings, control output is held in the ON state until the next OFF time. <ul style="list-style-type: none"> <li>• Operation after the output turns OFF (or ON) will be determined by the settings.</li> <li>• This function can be used with pulse-output operation.</li> </ul>	P.23
<b>Partial operation on specified day</b> 	The Time Switch operates according to only some of the settings on a user-specified day. Example (Sunday selected as specified day): Monday to Saturday: 8:00 to 12:00 (No. 1) 13:00 to 17:00 (No. 2) Sunday: 8:00 to 12:00 (No. 1) <ul style="list-style-type: none"> <li>• The Time Switch cannot be set to operate only on a specified day.</li> <li>• This function can be used with pulse-output operation.</li> </ul>	P.15
<b>Holiday Operation day</b> 	It is possible to set a day in the current week on which the Time Switch will not operate. When that day has passed, operation will continue according to the regular settings, and the Time Switch will operate as normal on that day from the following week. <ul style="list-style-type: none"> <li>• This function can be used with pulse-output operation.</li> </ul>	P.21

# 3. Selecting the Mode

All of the modes can be selected using **MODE**, **HOLIDAY**, and **TEST** Keys. Move to the desired mode using the method shown below.

- The days and times when output will actually turn ON/OFF are displayed chronologically. (Refer to page 25.)
- Set a special day when the Time Switch will not operate temporarily. (Refer to page 21.)

Program check function  
[TEST]

Holiday Setting Mode  
[HOLIDAY]

Note 1 **TEST** ↓ ↑ **TEST** (2 s min.) **HOLIDAY** ↓ ↑ **HOLIDAY** (2 s min.)

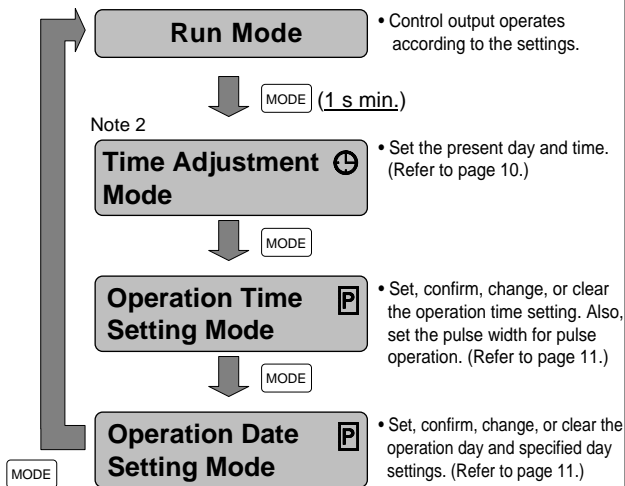

Note 1: After the last item is displayed, the mode automatically returns to run mode.  
Note 2: At the time of purchase, the mode is the run mode.

## 4. Setting the Time

**[Example]** Changing the current time setting from Wednesday 10:30 am to Monday 4:00 am.

- ① Press the **MODE** for 1 s min. to enter time adjustment mode. The  symbol flashes.

 The color indicates flashing  
SU MO TU WE TH FR SA

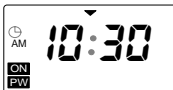

- ② Move the  symbol to Monday using the **d** Key. Change the time to 4:00 am using the **h** and **m/PWD** Keys.

SU MO TU WE TH FR SA

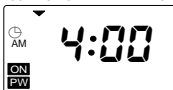

- ③ Press the **WRITE** Key. The colon will flash and the clock will start (from 0 s).

SU MO TU WE TH FR SA

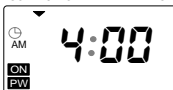

- ④ Press the **MODE** Key 3 times to return to the run mode.

SU MO TU WE TH FR SA



### «factory setting»

At the time of delivery, the mode is run mode and there is no current time setting. Before making any other settings, press the **MODE** Key for 1 s min, to enter time adjustment mode and set the current time using the above procedure.

<Display of factory setting >

SU MO TU WE TH FR SA

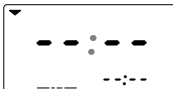

### «Note »

- The set time is enabled when the **WRITE** key is pressed.
- The time can be displayed in either 12-hour (am/pm) or 24-hour display.

## 5. Setting Timer Operation

**[Example]** Setting the Time Switch to operate from Monday to Friday between 8:30 am and 5:15 pm

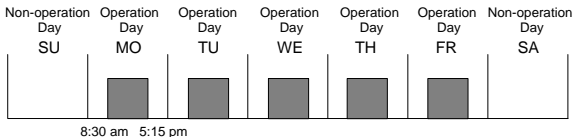

■ The color indicates flashing

- ① Enter operation time setting mode using the

**MODE** Key. The **P** symbol flashes.

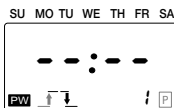

- ② Set the ON time to 8:30 am using the **h** and **m / P WD** Keys.

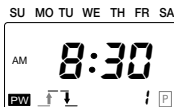

- ③ Press the **WRITE** Key.

(If only the hour or the minute (but not both) is set, the operation setting time display will flash to indicate an error.)

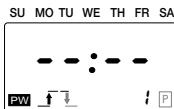

- ④ Set the OFF time to 5:15 pm using the **h** and **m / P WD** Keys.

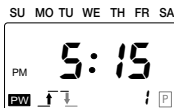

- ⑤ Press the **WRITE** Key.  
 (Repeat steps 2 to 5 to make other settings if necessary.)

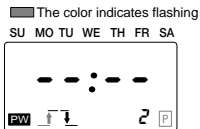

- ⑥ Press the **MODE** Key to enter operation date setting mode.

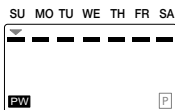

- ⑦ Move the ▼ symbol to Saturday (or Sunday) using the **d** Key. Clear the operation day indicator (■) by pressing the **WRITE** Key.

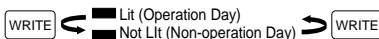
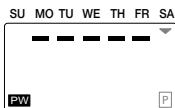

- ⑧ Press the **MODE** Key.  
 The Time Switch will enter run Mode and operation based on the settings will start.

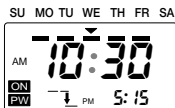

«Note»

- Up to 12 sets of ON-OFF settings are possible. Be sure to set both ON and OFF times. If only the ON time is set, the setting will be invalid.
- At the time of delivery, all days are set as operation days.
- Continuous operation for more than 24 hours is possible by combining 2 or more sets of settings. (Refer to pages 26 and 27.)
- pulse-output operation and timer operation cannot be used at the same time. (Refer to page 13.)

## 6. Setting pulse-output operation

Using pulse-output operation, the Time Switch can be set to operate at the same time every day for a fixed period.

**【Example】** Setting the Time Switch to turn ON for 30 s from 8:25 am, Monday to Friday.

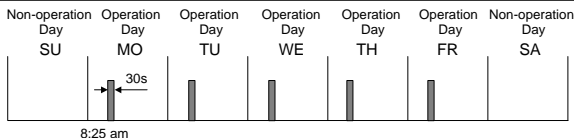

- ① Enter operation time setting mode using the

**MODE** Key. The **P** symbol flashes.

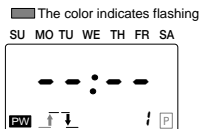

- ② Press the **TMR / P** Key to set the Time Switch for pulse-output operation. The **P** symbol flashes. (The Time Switch is set for timer operation at the time of delivery.)

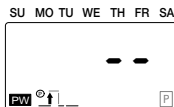

- ③ Set the pulse width to 30 s using the **m / P / WD** Key. (The pulse width can be set in the range 1 to 59 s or 1 to 60 min.)

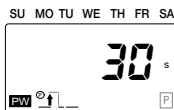

- ④ Press the **WRITE** Key.

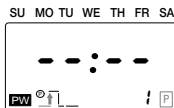

- ⑤ Set the ON time (the time when pulse-output operation starts) to 8:25 am using the **[h]** and **[m/ P WD]** Keys.

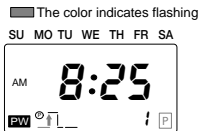

- ⑥ Press the **[WRITE]** Key.  
(Repeat steps ⑤ and ⑥ to make other settings if necessary.)

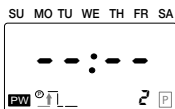

- ⑦ Press the **[MODE]** key to enter the operation date setting mode.

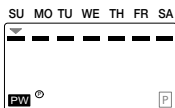

- ⑧ Move the ▼ symbol to Saturday (or Sunday) using the **[d]** Key. Clear the operation day indicator (■) by pressing the **[WRITE]** Key.

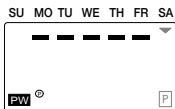
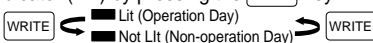

- ⑨ Press the **[MODE]** Key. The Time Switch will enter run mode and operation based on the settings will start.

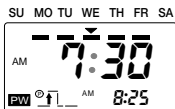

«Note»

- Up to 24 sets of settings are possible.
- Switching between timer operation and pulse-output operation will clear the operation start time, operation day, and pulse width settings.
- pulse-output operation and timer operation cannot be used at the same time.

## 7. Setting partial operation on specified day

The Time Switch can be set to operate according to only some of the settings on a user-specified day.

**【Example】** Monday to Friday: ON at 8:30 am; OFF at 0:30 pm  
 ON at 1:15 pm; OFF at 5:15 pm  
 Saturday: ON at 8:30 am; OFF at 0:30 pm

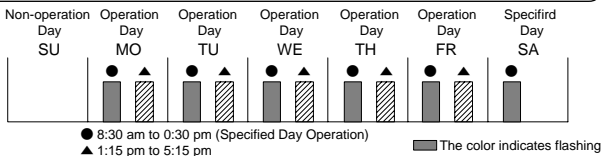

- ① Enter operation time setting mode using the

**MODE** Key.

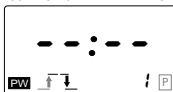

- ② Press the **SELECT** Key. The **S** symbol will be displayed. Set the ON time for the specified day to 8:30 am using the **h** and

**m / Ⓟ WD** Keys.

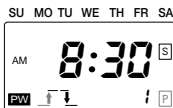

- ③ Press the **WRITE** Key.

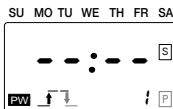

- ④ Set the OFF time for the specified day to 0:30 pm using the **h** and **m / Ⓟ WD** Keys.

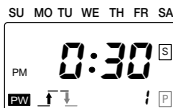



- ⑤ Press the **WRITE** Key.

Set the time to 1:15 pm using the **h** and **m / P WD** Keys.

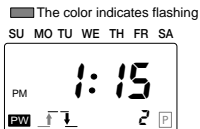

- ⑥ Press the **WRITE** Key.

Set the time to 5:15 pm using the **h** and **m / P WD** Keys.

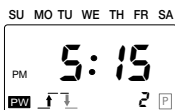

- ⑦ Press the **WRITE** Key.

Press the **MODE** Key to enter operation date setting mode.

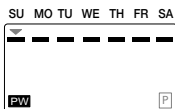

- ⑧ Move the ▼ symbol to Saturday using the **d** Key.

Set the operation day indicator to specified day by pressing the **WRITE** Key. And move the ▼ symbol to Sunday using the **d** Key. Clear the operation day indicator by pressing the **WRITE** Key.

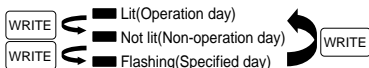
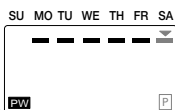

- ⑨ Press the **MODE** Key.

The Time Switch will enter run mode and operation based on the settings will start. The operation day indicator (■) of the specified day will flash.

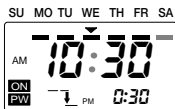

«Note»

- specified operation can be set for two or more programs. The specified day must be specified, however, for each program using the **SELECT** Key.
- Two or more days can be specified as specified days.
- specified days can also be specified for pulse-output operation.

## 8. Changing (Confirming) Settings

Changing (confirming) timer operation settings

【Example1】 Changing the ON time for program No.1 from 8:30 am to 7:45 am

- ① Enter operation time setting mode using the **MODE** Key. The ON time for program No.1 will be displayed.

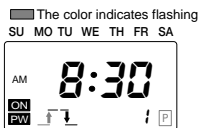

- ② Change the ON time to 7:45 am using the **h** and **m / PWD** Keys.



- ③ Press the **WRITE** Key. The OFF time for program No.1 will be displayed. (The changes will not be enabled unless the **WRITE** Key is pressed. Make changes, if necessary, using the same procedure as for ON time.)

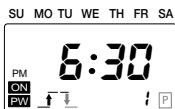

- ④ Press the **MODE** Key to enter operation date setting mode. The operation dates will be displayed. (Make changes, if necessary, using the **d** and **WRITE** Keys.)

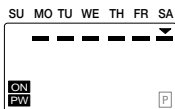

- ⑤ Press the **MODE** Key. The Time Switch will enter run mode and operation will start.

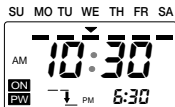

《《Note》》

- Operation based on the changed settings will start as soon as the Time Switch returns to run mode.

Changing (confirming) pulse-output operation settings  
**【Example2】** Changing the pulse width from 30 s to 20 s

- ① Enter operation time setting mode using **MODE** key. The pulse width is displayed.

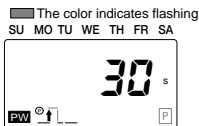

- ② Change the pulse width to 20 s using **m / P WD** Key.

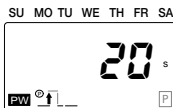

- ③ Press the **WRITE** Key. The ON time for program No.1 will be displayed.  
 (The changes will not be enabled unless **WRITE** Key is pressed. Make changes, if necessary, using the **h** and **m / P WD** key.)

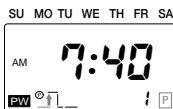

- ④ Press the **MODE** key to enter operation date setting mode. The operation dates will be displayed. (Make changes, if necessary, using the **d** and **WRITE** key.)

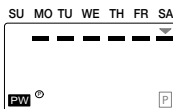

- ⑤ Press the **MODE** Key. The Time Switch will enter run mode and operation will start.

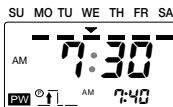

《《Note》》

- Operation based on the changed settings will start as soon as the Time Switch returns to run mode.

## 9. Clearing the Settings

Clearing the settings for individual programs  
【Example 1】 Clearing the settings for program No.2

- ① Enter operation time setting mode using **MODE** Key. The ON time for program No.1 will be displayed.

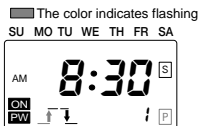

- ② Press the **WRITE** Key 2 times to display the settings for program No.2.

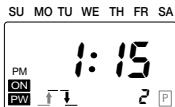

- ③ Press the **CLR** Key. (Both the ON and OFF settings are cleared with just one operation. Output is temporarily maintained by the condition before setting is cleared.)

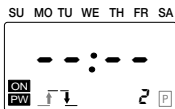

- ④ Press the **MODE** Key twice. The Time Switch will enter run mode and operation based on the new settings will start.

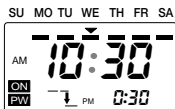

### «Note»

- Settings for pulse-output operation can be cleared for individual programs in the same way.

## Clearing all settings

- ① Enter operation time setting mode or operation date setting mode using the **MODE** Key.

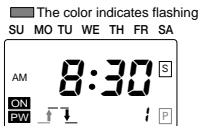

- ② Press the **CLR** Key for 3 s min. The display will flash [CLR]. It will stop flashing when the settings have been cleared.



- ③ When all the settings have been cleared, the operation time, operation day, pulse width, holiday, specified day, and partial automatic operation settings will be returned to their factory settings.

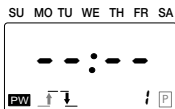

### «Note»

- The clearing process will be canceled if the **CLR** Key is released while [CLR] is still flashing and only the settings for the display program will be cleared.

## 10. Setting (Temporary) Holidays

Stopping operation for a certain day in the current week and restoring normal operation from the following week

**【Example】** Stopping operation for Friday and Saturday in the current week and resuming normal operation from the following week

- ① Press the **HOLIDAY** Key for 2 s min. In run mode to enter holiday setting mode. **[HdRY]** will flash and the operation day indicator ( **■** ) will light under the days set for operation day.

■ The color indicates flashing



- ② Move the ▼ symbol to Friday using **d** Key. Clear the operation day indicator ( **■** ) by pressing the **WRITE** Key. Repeat the procedure for Saturday. (Press the **WRITE** Key again to clear the holiday setting.)



- ③ Press the **HOLIDAY** Key. The Time Switch will enter run mode and the operation day indicator under the days set as holidays will turn OFF.

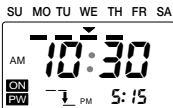

### «Note»

- Any day in the 7-day period starting from the present day can be set as a holiday.
- When a day set as a holiday has passed, the **■** indicator under that day will automatically turn ON again.
- Holiday setting mode can be entered from run mode only.
- Operation based on the new settings (i.e., including the holiday setting) will start as soon as the Time Switch returns to run mode.
- If the present day setting in time adjustment mode is changed, all holiday settings will be cleared.
- If a day set as a holiday is changed in operation date setting mode, the holiday setting for that day will be cleared.

## 11. Summer Time (DST)

Each time the **[+1h]** Key is pressed, the present time will Time Switch between the (standard) present time and the present time + 1 hour (summer time).

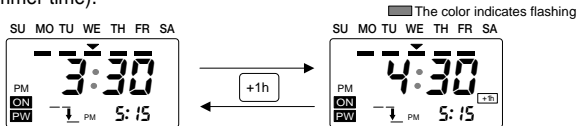

### «Note»

- The **[+1h]** symbol is displayed while summer time is set.
- The summer time setting can only be set or cleared in run mode.

## 12. Switching between 12-hour (am/pm) and 24-hour Display

Each time the **[h]** Key is pressed for 2 s min., the time display switches between 12-hour (am/pm) and 24-hour display.

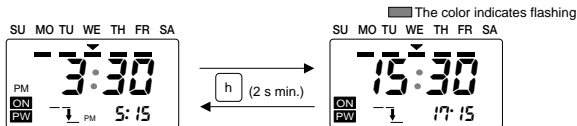

### «Note»

- Switching is possible only in run mode.
- The factory setting is 12-hour (am/pm) display.

## 13. Override and automatic return operation

In Override and automatic return operation, the status can be set to ON or OFF directly using the Out ON/OFF switch. This status is then held until the next ON/OFF operation based on the regular settings.

**【Example 1】** Regular setting: ON at 8:30 am; OFF at 5:15 pm  
Use the following procedure to start operation at 7:00 am for the present day only.



- ① Change the setting of the Out ON/OFF switch from Auto to ON.
- ② Return the setting of the Out ON/OFF switch from ON to Auto while holding down the **[WRITE]** Key. The ON state will be held from the point at which this operation is performed (indicated by the arrow) until the next (regular) OFF time.



**【Example 2】** Regular setting: ON at 8:30 am; OFF at 5:15 pm  
Use the following procedure to stop operation at 3:00 pm for the present day only.

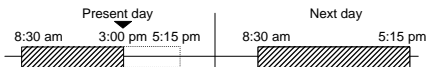

- ① Change the setting of the Out ON/OFF switch from Auto to OFF.
- ② Return the setting of the Out ON/OFF switch from OFF to Auto while holding down the **[WRITE]** Key. The OFF state will be held from the point at which this operation is performed (indicated by the arrow) until the next (regular) ON time.



### 《Note》

- This operation is possible in run mode only.
- Override and automatic return operation can be cleared by setting the Out ON/OFF switch to the opposite of the present status. For example, if the output is ON, partial automatic operation can be cleared by setting the Out ON/OFF switch to OFF.
- **Override and automatic return operation cannot be set or cleared if power is not being supplied to the Time Switch.**
- **Override and automatic return operation is cleared if any of the settings are changed.**



## 【Using Override and automatic return operation for pulse-output operation】

Pulse-output operation proceeds in the following way when used for pulse-output operation.

- If Override and automatic return operation is turned ON, output is turned ON for the set pulse width.
- If Override and automatic return operation is turned OFF, output remains OFF until the scheduled end of pulse output.

The operation method is the same as for timer operation.

【Example1】 Override and automatic return operation turned ON while output is ON (pulse width: 30 min)

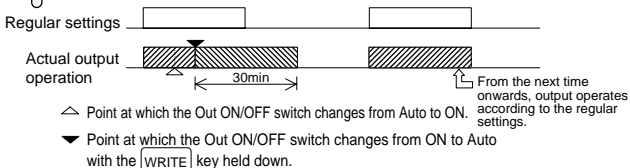

【Example2】 Override and automatic return operation turned ON while output is OFF (pulse width: 30 min)

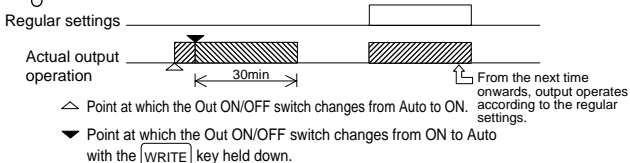

【Example3】 Override and automatic return operation turned OFF while output is OFF

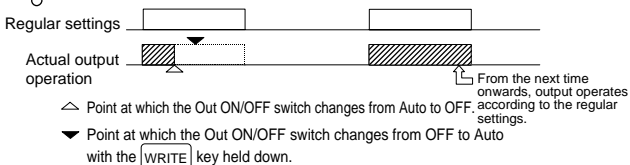

# 14. Program check function

The days and times at which output turns ON or OFF over the course of one week can be displayed continuously in the actual order in which they will occur.

- ① Press the **TEST** Key for 2 s min. in run mode to start program check. The display will flash [E E 5 E] and the day and time of the next change in output status will be displayed.

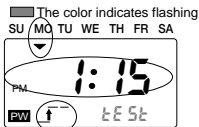

In the above example, output will turn ON at 1:15 pm on Monday.

- ② Press the **WRITE** Key. The display will change to the time of the next change in output status. (Continue pressing the **WRITE** Key to display the days and times for one week.)



In the above example, output will turn OFF at 5:30 pm on Monday.

- ③ If the **WRITE** Key is pressed with the last setting for the week displayed, [End] is displayed for 2 s and then the Time Switch automatically returns to run mode.

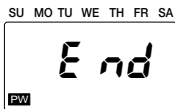

## «Note»

- Program check function can be entered from run mode only.
- Press the **TEST** Key again to return to run mode before reaching the end of the program check function display sequence.
- The [ ] and [ ] symbols displayed in test mode have no effect on the present operation.
- Only ON times are displayed for pulse-output operation.

## 15. Operation while the Power Supply is OFF

- ① Output turns OFF. The output indicator and power indicator turn OFF.
- ② The Current day Indicator and next operation Indicator are updated.
- ③ Operation is possible for all settings except those for Override and automatic return operation.
- ④ The settings are backed up using a lithium battery.  
(The battery is not user-replaceable.)

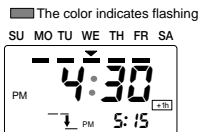

The service life of the lithium battery is as follows:

5 years min.(25 °C)    10 years min.(Power-interruption rate of 50%)

## 16. Setting Precautions

1. If settings overlap, the earliest ON time and the latest OFF time will be used.

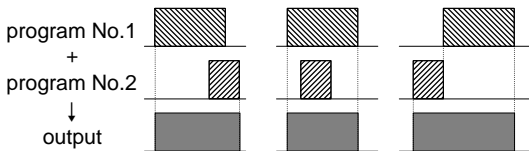

- Output will stay ON continuously without interruption.
  - If an ON and OFF setting are made for the same time, the output status will not change at that time.
2. If there is a switch between timer operation and pulse-output operation, the operation time, operation day, and pulse width settings will all be cleared.

## 17. Setting examples

**【Example1】** Use the settings given below to turn ON output from 8:30 am on Monday right through to 0:30 pm on Saturday.

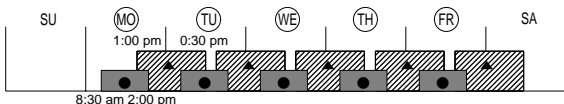

Operation time settings:

- ▲ 1:00 pm to 0:30 pm
- 8:30 am to 2:00 pm

Operation date settings:

Operation Day(○) MO,TU,WE,TH,FR

**【Example2】** Use the settings given below to turn ON output from 1:00 pm on Monday right through to 8:00 am on Saturday.

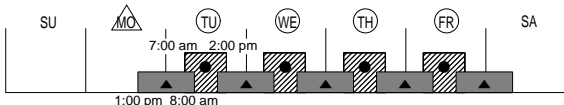

Operation time settings:

- ▲ 1:00 pm to 8:00 am (specified operation)
- 7:00 am to 2:00 pm

Operation date settings:

Specified day(△) MO  
Operation Day(○) TU,WE,TH,FR

**【Example3】** Use the settings given below to turn ON output from 8:00 pm to 7:00 am from Monday to Thursday and from 8:00 pm on Friday right through to 7:00 am on Monday.

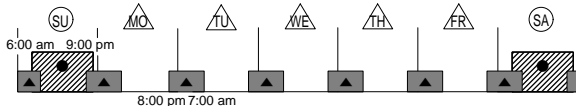

Operation time settings:

- ▲ 8:00 pm to 7:00 am (specified operation)
- 6:00 am to 9:00 pm

Operation date settings:

Specified day(△) MO,TU,WE,TH,FR  
Operation Day(○) SU,SA

### 《《Note》》

- As shown in the above examples, continuous operation for more than 24 hours is possible by combining two or more settings. Refer to Setting Precautions for more details.

# 18. Troubleshooting

Problem	Probable cause and countermeasure	Reference page
The Time Switch does not operate when the power is turned ON.	Is the power actually ON? Check that the power is ON using the display.	P.7
	Is the Time Switch wired correctly? Check the wiring.	P.31
The Time Switch does not operate according to the settings.	Is the present time correct? Set the present time correctly.	P.10
	Is the Time Switch set correctly? Check the settings.	P.17,25
	Is the Out ON/OFF switch set to ON or OFF? Set the Out ON/OFF switch to Auto.	—
	Is the Time Switch set for Override and automatic return operation? Clear Override and automatic return operation.	P.23
Output does not turn ON when the Out ON/OFF switch is set to ON.	Is power being supplied to the Time Switch? Check that the power is ON using the display.	P.7
The time is fast or slow.	The timing accuracy is influenced by the ambient temperature. Correct the present time in time adjustment mode.	P.10
	Is the Time Switch installed in a location subject to excessive noise? Timing performance may be adversely affected if the Time Switch is installed in a location subject to excessive noise. Separate the Time Switch from any sources of noise.	—
The display is incorrect.	It is possible that the Time Switch is subject to the influence of noise or surge. Separate the Time Switch from any sources of noise.	—

# Installation

## 1. Dimensions and Mounting Dimensions

### H5F-B (Flush-mounting Model)

[mm]

#### ● Dimensions

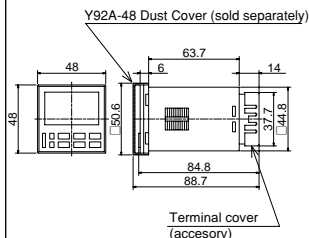

#### ● Mounting Dimensions

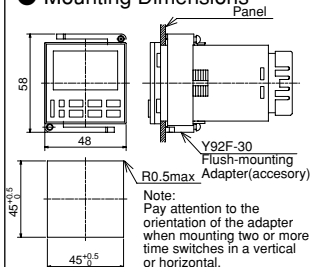

### H5F-FB (Surface-mounting Model)

[mm]

#### ● Dimensions

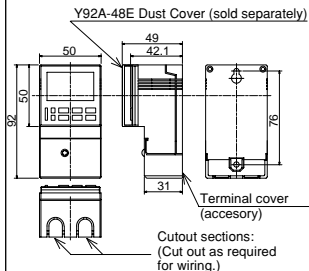

#### ● Mounting Dimensions

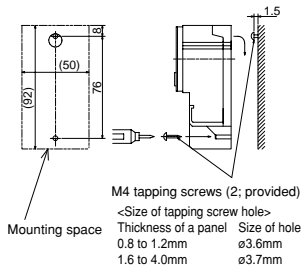

# H5F-KB(Surface/Track Mounting Models) [mm]

## ● Dimensions

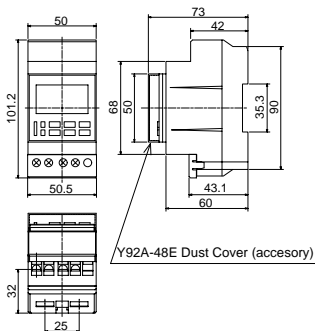

## ● Mounting Dimensions

### DIN Track mounting

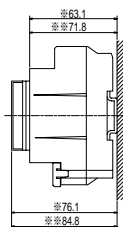

### Mounting with a mounting bracket

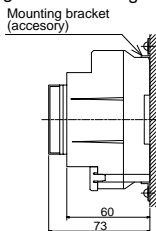

### M4 tapping screw hole

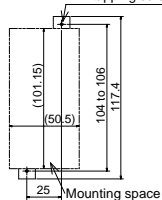

- ※ : Dimensions when using PFP-100N or PFP-50N DIN Track.
- ※※ : Dimensions when using PFP-100N2 DIN Track.

<Size of tapping screw hole>

Thickness of a panel	Size of hole
0.8 to 1.2mm	$\varnothing 3.6\text{mm}$
1.6 to 4.0mm	$\varnothing 3.7\text{mm}$

## ■ Applicable DIN Track

PFP-100N, PFP-50N, PFP-100N2

## 2. Connections

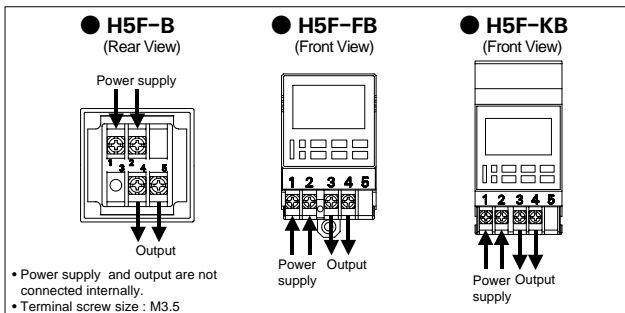

## 3. Wiring

Read the following information before performing wiring.

- The Time Switch output is no-voltage contact output. A power supply must be provided to drive the load. Perform wiring according to the information on the next page.
- When driving an inductive load (e.g., coil), a surge voltage is generated when the contacts (i.e., Time Switch output) are switched, and in some cases this may damage other devices connected to the Time Switch or the same line. Absorb the surge with a capacitor and resistor as shown in the following diagram.

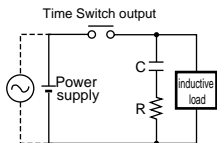

As a rough guide, the capacitor (C) and resistor (R) should have the following specifications:

C: 0.5 to 1  $\mu\text{F}$  for a switching current of 1 A

R: 0.5 to 1  $\Omega$  for a switching voltage of 1 V

- Use a capacitor with a dielectric strength appropriate for the power supply voltage.

Use an AC-type capacitor with AC circuits.

There may be cases where, due to inconsistencies in the nature and characteristics of the load, delays in restoring the load may cause problems. Be sure to confirm that correct operation is possible under the actual operating conditions.



## ● Separate Power Supplies for Time Switch and Load

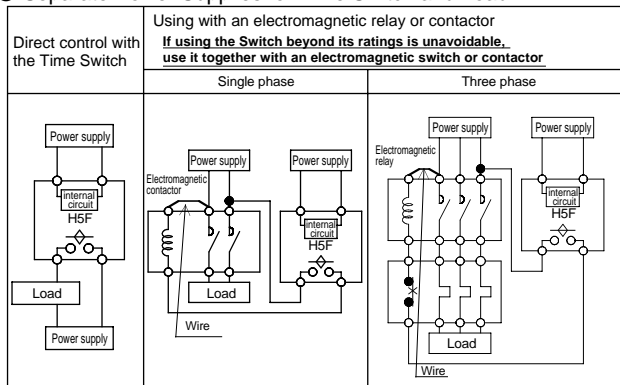

## ● Common Power Supply for Time Switch and Load

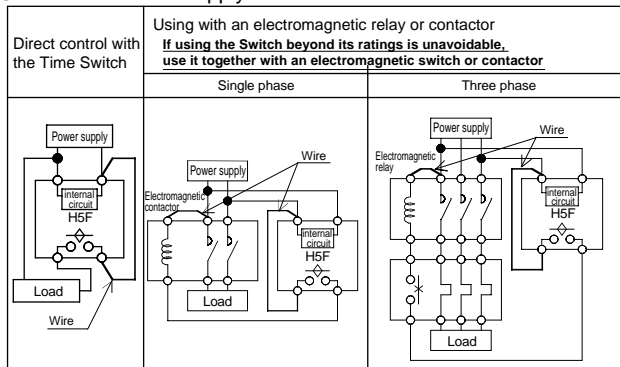

■ Applicable wire : 600V vinyl-insulated wire (solid wire or stranded wire, copper)  
14 to 24 AWG

Up to two wires of the same size and type can be inserted into a single terminal. Strip length :  $11 \pm 1$  mm.

■ Applicable tightening torque : 8.67 to 10.4 in.lb. (0.98 to 1.17 N·m)

■ Recommended fuse : T2A AC250V T2A, 250 VAC, time delay, low breaking capacity

## 4. Output (Built-in Relay) Life Expectancy

- Mechanical life expectancy at 20°C 100,000 operations
- Electrical life expectancy at 20°C
  - 50,000 operations min. for a resistive load of 15 A at 250 VAC
  - 50,000 operations min. for an inductive load (cos $\phi$  = 0.7) of 10 A at 250 VAC
  - 50,000 operations min. for a motor load of 1 HP at 250 VAC
  - 50,000 operations min. for a lamp load of 100 W at 100 VAC
  - 10,000 operations min. for a lamp load of 300 W at 100 VAC

The higher the ambient temperature is, the shorter the Time Switch's life expectancy will be.

## 5. Ratings and Performance Characteristics

Supply voltage		24VDC (H5F-B-90) 100 to 240VAC 50/60Hz(other)	Setting	Minimum setting interval	1min
Operating voltage range		85 to 110% of rated voltage		Pulse width	Can be set to 1to 59s in units of 1 second and to 1 to 60min in units of 1 minute.
Power consumption		Approx.0.5W(H5F-B-90) Approx.2.4VA(other)	Load	Operations	ON/OFF operation:24 (12 sets of ON and OFF operations) pulse-output operation:24
Capacity	Number of circuits	1(independent)			
	Circuit	Separated from power circuit (no-voltage)			
Capacity	Configuration	Contact output(SPST-NO)	Installation environment	Over-voltage category II, pollution degree 2 (as per IEC61010-1)	
	Resistive	AC250V 15A	Altitude	MAX. 2,000 m	
	Inductive	AC250V 10A(cos $\phi$ =0.7)	Vibration	Mechanical durability	10 to 55Hz,0. 75mm double amplitude
Ambient operating temperature		-10 to +55°C (Avoid freezing or condensation)		Malfuction durability	10 to 55Hz,0. 5mm double amplitude
Ambient Storage temperature		-25 to +65°C (Avoid freezing or condensation)	Shock	Mechanical durability	300m/s <sup>2</sup>
Ambient humidity		35 to 85 %		Malfuction durability	100m/s <sup>2</sup>
Total error (Note1)		±0.01% ±50ms max.	Standards	UL508(Listing) CSA C22.2 No.14(cULus) EN61010-1(IEC61010-1) EN61326 VDE0106/part100	
Cyclic error		Monthly difference 15s (25°C)			
Memory protection		5 years min. 10 years min (Power-interruption rate of 50%) Note2			

Note 1: The total error including the repeat accuracy, setting error, variation due to voltage change, and variation due to temperature change is  $\pm 0.01\% \pm 0.05s$  maximum.

Note 2: These figures are accumulated times.

## 6. EN/IEC Standards

Basic insulation is used between the power supply and outputs. Connect the output terminals only to devices without exposed charged parts and with the basic insulation appropriate for the maximum operating voltage.

For 24VDC input type

Connect the power supply terminals only to devices without exposed charged parts and with the basic insulation appropriate for the maximum operating voltage.

## 7. Record of Settings

Use the following chart to record important settings.

	0	1	2	3	4	5	6	7	8	9	10	11	12	13	14	15	16	17	18	19	20	21	22	23	24
SU																									
MO																									
TU																									
WE																									
TH																									
FR																									
SA																									

## Contact Address

<p>U.S.A            OMRON ELECTRONICS LLC            ONE COMMERCE DRIVE            SCHAUMBURG, IL 60173-5302 U.S.A            Phone: 1-800-55-OMRON            Phone: 1-847-843-7900            Fax: 1-847-843-7787</p>	<p>AUSTRALIA            OMRON ELECTRONICS PTY.LTD.            71 Epping Road, North Ryde,            Sydney NSW            2113 Australia            Phone: 61-2-9878-6377            Fax: 61-2-9878-6981</p>
<p>CANADA            OMRON CANADA INC.            885 Milner Avenue, Scarborough, Ontario,            M1B 5V8 CANADA            Phone: 1-416-286-6465            Phone: 1-514-636-6676(French Language)            Fax: 1-416-286-6648</p>	<p>SINGAPORE            OMRON ELECTRONICS PTE. LTD.            55 Ubi Avenue 1            #05-01, Singapore 408935            Phone: 65-6547-6789            Fax: 65-6547-6766</p>
<p>Europe/ Middle East Asia/ Africa/ RUSSIA            OMRON Europe B.V.            Wegalaan 67-69 2132 JD            Hoofddorp - The Netherlands            Phone: +31 (0)23 56 81 300            Fax: +31 (0)23 56 81 388            Web site :www.eu.omron.com</p>	<p>中国            欧姆龍（中国）有限公司            北京市朝陽區東三環中路39号建外            SOHO B32層            Phone: 86-10-5869-3030            Fax: 86-10-5869-3815</p>
<p>UNITED KINGDOM            OMRON ELECTRONICS LTD.            Opal Drive, Fox Milne, Milton Keynes            MK15 ODG (UNITED KINGDOM)            Phone: 44-1908-258-258            Fax: 44-1908-258-158</p>	<p>香港            歐姆龍亞洲有限公司            香港九龍尖沙咀廣東道25号港威大廈            第2座601-9室            Phone: 852-2375-3827            Fax: 852-2375-1475</p>
<p>GERMANY            OMRON ELECTRONICS G.m.b.H            Elisabeth-Selbert-Strasse 17,            40764 Langenfeld            (GERMANY)            Phone: 49-2173-6800-0            Fax: 49-2173-6800-400</p>	<p>台灣            台灣歐姆龍股 有限公司            台北市復興北路363號弘雅大樓 6 樓            Phone: 886-2-2715-3331            Fax: 886-2-2712-6712</p>
<p>FRANCE            OMRON ELECTRONICS S.a.r.l            14 rue de Lisbonne 93561            ROSNY SOUS            BOIS FRANCE            Phone: 33-1-5663-7000            Fax: 33-1-4855-9086</p>	<p>大韓民国            Contron Corporation (Automation Distributor)            KOREA 2F, Daeryung, technotown-8,            481-11, Gasan-dong, Kumchon-gu,            Seoul, 153-023 Korea            Phone: 82-2-3218-5700            Fax: 82-2-2163-0599</p>