

SYSMAC CJ Series

CJ1W-AD04U

CJ1W-AD04U-SL

Universal Input Units

OPERATION MANUAL

OMRON

SYSMAC CJ Series

CJ1W-AD04U

CJ1W-AD04U-SL

Universal Input Units

Operation Manual

Revised December 2007

Notice:

OMRON products are manufactured for use according to proper procedures by a qualified operator and only for the purposes described in this manual.

The following conventions are used to indicate and classify precautions in this manual. Always heed the information provided with them. Failure to heed precautions can result in injury to people or damage to property.

 **DANGER** Indicates an imminently hazardous situation which, if not avoided, will result in death or serious injury. Additionally, there may be severe property damage.

 **WARNING** Indicates a potentially hazardous situation which, if not avoided, could result in death or serious injury. Additionally, there may be severe property damage.

 **Caution** Indicates a potentially hazardous situation which, if not avoided, may result in minor or moderate injury, or property damage.

OMRON Product References

All OMRON products are capitalized in this manual. The word “Unit” is also capitalized when it refers to an OMRON product, regardless of whether or not it appears in the proper name of the product.

The abbreviation “Ch,” which appears in some displays and on some OMRON products, often means “word” and is abbreviated “Wd” in documentation in this sense.

The abbreviation “PLC” means Programmable Controller. “PC” is used, however, in some Programming Device displays to mean Programmable Controller.

Visual Aids

The following headings appear in the left column of the manual to help you locate different types of information.

Note Indicates information of particular interest for efficient and convenient operation of the product.

1,2,3... 1. Indicates lists of one sort or another, such as procedures, checklists, etc.

© OMRON, 2006

All rights reserved. No part of this publication may be reproduced, stored in a retrieval system, or transmitted, in any form, or by any means, mechanical, electronic, photocopying, recording, or otherwise, without the prior written permission of OMRON.

No patent liability is assumed with respect to the use of the information contained herein. Moreover, because OMRON is constantly striving to improve its high-quality products, the information contained in this manual is subject to change without notice. Every precaution has been taken in the preparation of this manual. Nevertheless, OMRON assumes no responsibility for errors or omissions. Neither is any liability assumed for damages resulting from the use of the information contained in this publication.

TABLE OF CONTENTS

PRECAUTIONS	xv
1 Intended Audience	xvi
2 General Precautions	xvi
3 Safety Precautions	xvi
4 Operating Environment Precautions	xvii
5 Application Precautions	xviii
6 Conformance to EC Directives	xx
SECTION 1	
Features and System Configuration	1
1-1 Features and Functions	2
1-2 System Configuration	5
1-3 Operating Procedure	7
1-4 Functions Listed by Purpose	7
SECTION 2	
Specifications and Component Names	9
2-1 Specifications	10
2-2 Input Types and Data Conversion	12
2-3 Nomenclature and Functions	15
SECTION 3	
Installation and Wiring	17
3-1 Installing the Units	18
3-2 Wiring	19
SECTION 4	
Input Functions and Operating Procedures	23
4-1 Exchanging Data with the CPU Unit	24
4-2 Detailed Description of User Settings Area Data	33
4-3 Expansion Setting Area	39
SECTION 5	
Error Processing	43
5-1 Indicators and Error Flowchart	44
5-2 Errors Detected by the Universal Input Unit	44
5-3 Errors Related to the CPU Unit	46
5-4 Restarting Special I/O Units	46
5-5 Troubleshooting	48

TABLE OF CONTENTS

Appendices

A	Dimensions	49
B	Supplementary Explanations of Functions	51
C	Data Coding Tables	55

Revision History	57
-------------------------------	-----------

About this Manual:

This manual describes the specifications, installation, troubleshooting, and other information on the CJ1W-AD04U and CJ1W-AD04U-SL Universal Input Units. This manual includes the sections described below.

Please read this manual and the other manuals related to the Universal Input Units carefully and be sure you understand the information provided before attempting to install and operate the Units. The manuals used with the Universal Input Units are listed in the following table. The suffixes have been omitted from the catalog numbers. Be sure you are using the most recent version for your area.

Name	Cat. No.	Contents
SYSMAC CJ-series CJ1G-CPU□□, CJ1G/H-CPU□□H, CJ1M-CPU□□ Programmable Controllers Operation Manual	W393	Describes the installation and operation of the CJ-series PLCs.
SYSMAC CS/CJ-series CS1G/H-CPU□□-EV1, CS1G/H-CPU□□H, CJ1G-CPU□□, CJ1G/H-CPU□□H, CJ1M-CPU□□ Programmable Controllers Programming Manual	W394	Describes the programming methods required to use the functions of the CS/CJ-series PLCs.
SYSMAC CS/CJ-series CS1G/H-CPU□□-EV1, CS1G/H-CPU□□H, CJ1G-CPU□□, CJ1G/H-CPU□□H, CJ1M-CPU□□ Programmable Controllers Instructions Reference Manual	W340	Describes the ladder diagram programming instructions supported by CS/CJ-series PLCs.
SYSMAC WS02-CXPC1-EV70 CX-Programmer Ver. 7.0 Operation Manual	W446	Provides information on how to use the CX-Programmer, a programming device that supports the CS/CJ-series PLCs.
SYSMAC CS/CJ-series CQM1H-PRO01-E, CQM1-PRO01-E, C200H-PRO27-E Programming Consoles Operation Manual	W341	Provides information on how to program and operate CS/CJ-series PLCs using a Programming Console.

Section 1 introduces the features and primary functions, describes the system configuration, and outlines the operating procedure.

Section 2 describes the specifications, component names, and switch settings of the CJ1W-AD04U and CJ1W-AD04U-SL Universal Input Units.

Section 3 explains how to install and wire the CJ1W-AD04U and CJ1W-AD04U-SL Universal Input Units.

Section 4 describes the input functions and operating procedures of the CJ1W-AD04U and CJ1W-AD04U-SL Universal Input Units.

Section 5 explains how to troubleshoot errors and alarms that occur in the CJ1W-AD04U and CJ1W-AD04U-SL Universal Input Units.

Appendix A provides details on dimensions.

Appendix B provides supplementary explanations of functions.

Appendix C provides data coding tables.

 **WARNING** Failure to read and understand the information provided in this manual may result in personal injury or death, damage to the product, or product failure. Please read each section in its entirety and be sure you understand the information provided in the section and related sections before attempting any of the procedures or operations given.

Read and Understand this Manual

Please read and understand this manual before using the product. Please consult your OMRON representative if you have any questions or comments.

Warranty and Limitations of Liability

WARRANTY

OMRON's exclusive warranty is that the products are free from defects in materials and workmanship for a period of one year (or other period if specified) from date of sale by OMRON.

OMRON MAKES NO WARRANTY OR REPRESENTATION, EXPRESS OR IMPLIED, REGARDING NON-INFRINGEMENT, MERCHANTABILITY, OR FITNESS FOR PARTICULAR PURPOSE OF THE PRODUCTS. ANY BUYER OR USER ACKNOWLEDGES THAT THE BUYER OR USER ALONE HAS DETERMINED THAT THE PRODUCTS WILL SUITABLY MEET THE REQUIREMENTS OF THEIR INTENDED USE. OMRON DISCLAIMS ALL OTHER WARRANTIES, EXPRESS OR IMPLIED.

LIMITATIONS OF LIABILITY

OMRON SHALL NOT BE RESPONSIBLE FOR SPECIAL, INDIRECT, OR CONSEQUENTIAL DAMAGES, LOSS OF PROFITS OR COMMERCIAL LOSS IN ANY WAY CONNECTED WITH THE PRODUCTS, WHETHER SUCH CLAIM IS BASED ON CONTRACT, WARRANTY, NEGLIGENCE, OR STRICT LIABILITY.

In no event shall the responsibility of OMRON for any act exceed the individual price of the product on which liability is asserted.

IN NO EVENT SHALL OMRON BE RESPONSIBLE FOR WARRANTY, REPAIR, OR OTHER CLAIMS REGARDING THE PRODUCTS UNLESS OMRON'S ANALYSIS CONFIRMS THAT THE PRODUCTS WERE PROPERLY HANDLED, STORED, INSTALLED, AND MAINTAINED AND NOT SUBJECT TO CONTAMINATION, ABUSE, MISUSE, OR INAPPROPRIATE MODIFICATION OR REPAIR.

Application Considerations

SUITABILITY FOR USE

OMRON shall not be responsible for conformity with any standards, codes, or regulations that apply to the combination of products in the customer's application or use of the products.

At the customer's request, OMRON will provide applicable third party certification documents identifying ratings and limitations of use that apply to the products. This information by itself is not sufficient for a complete determination of the suitability of the products in combination with the end product, machine, system, or other application or use.

The following are some examples of applications for which particular attention must be given. This is not intended to be an exhaustive list of all possible uses of the products, nor is it intended to imply that the uses listed may be suitable for the products:

- Outdoor use, uses involving potential chemical contamination or electrical interference, or conditions or uses not described in this manual.
- Nuclear energy control systems, combustion systems, railroad systems, aviation systems, medical equipment, amusement machines, vehicles, safety equipment, and installations subject to separate industry or government regulations.
- Systems, machines, and equipment that could present a risk to life or property.

Please know and observe all prohibitions of use applicable to the products.

NEVER USE THE PRODUCTS FOR AN APPLICATION INVOLVING SERIOUS RISK TO LIFE OR PROPERTY WITHOUT ENSURING THAT THE SYSTEM AS A WHOLE HAS BEEN DESIGNED TO ADDRESS THE RISKS, AND THAT THE OMRON PRODUCTS ARE PROPERLY RATED AND INSTALLED FOR THE INTENDED USE WITHIN THE OVERALL EQUIPMENT OR SYSTEM.

PROGRAMMABLE PRODUCTS

OMRON shall not be responsible for the user's programming of a programmable product, or any consequence thereof.

Disclaimers

CHANGE IN SPECIFICATIONS

Product specifications and accessories may be changed at any time based on improvements and other reasons.

It is our practice to change model numbers when published ratings or features are changed, or when significant construction changes are made. However, some specifications of the products may be changed without any notice. When in doubt, special model numbers may be assigned to fix or establish key specifications for your application on your request. Please consult with your OMRON representative at any time to confirm actual specifications of purchased products.

DIMENSIONS AND WEIGHTS

Dimensions and weights are nominal and are not to be used for manufacturing purposes, even when tolerances are shown.

PERFORMANCE DATA

Performance data given in this manual is provided as a guide for the user in determining suitability and does not constitute a warranty. It may represent the result of OMRON's test conditions, and the users must correlate it to actual application requirements. Actual performance is subject to the OMRON Warranty and Limitations of Liability.

ERRORS AND OMISSIONS

The information in this manual has been carefully checked and is believed to be accurate; however, no responsibility is assumed for clerical, typographical, or proofreading errors, or omissions.

PRECAUTIONS

This section provides general precautions for using the Universal Input Units.

The information contained in this section is important for the safe and reliable application of the Universal Input Unit. You must read this section and understand the information contained before attempting to set up or operate a Universal Input Unit.

1	Intended Audience	xvi
2	General Precautions	xvi
3	Safety Precautions	xvi
4	Operating Environment Precautions	xvii
5	Application Precautions	xviii
6	Conformance to EC Directives	xx

1 Intended Audience

This manual is intended for the following personnel, who must also have knowledge of electrical systems (an electrical engineer or the equivalent).

- Personnel in charge of installing FA systems
- Personnel in charge of designing FA systems
- Personnel in charge of managing FA systems and facilities

2 General Precautions

The user must operate the product according to the performance specifications described in the operation manuals.

Before using the product under conditions which are not described in the manual or applying the product to nuclear control systems, railroad systems, aviation systems, vehicles, combustion systems, medical equipment, amusement machines, safety equipment, and other systems, machines, and equipment that may have a serious influence on lives and property if used improperly, consult your OMRON representative.

Make sure that the ratings and performance characteristics of the product are sufficient for the systems, machines, and equipment, and be sure to provide the systems, machines, and equipment with double safety mechanisms.

This manual provides information for operating the OMRON Universal Input Units. Be sure to read this manual before attempting to use a Universal Input Unit and keep this manual close at hand for reference during operation.

 **WARNING** It is extremely important that a PLC and all PLC Units be used for the specified purpose and under the specified conditions, especially in applications that can directly or indirectly affect human life. You must consult with your OMRON representative before applying a PLC System to the above-mentioned applications.

3 Safety Precautions

 **WARNING** Do not attempt to take any Unit apart while power is being supplied. Doing so may result in electric shock.

 **WARNING** Provide safety measures in external circuits (i.e., not in the Programmable Controller), including the following items, in order to ensure safety in the system if an abnormality occurs due to malfunction of the PLC or another external factor affecting the PLC operation. Not doing so may result in serious accidents.

- Emergency stop circuits, interlock circuits, limit circuits, and similar safety measures must be provided in external control circuits.
- The PLC will turn OFF all outputs when its self-diagnosis function detects any error or when a severe failure alarm (FALS) instruction is executed. As a countermeasure for such errors, external safety measures must be provided to ensure safety in the system.
- The PLC outputs may remain ON or OFF due to deposition or burning of the output relays or destruction of the output transistors. As a counter-

measure for such problems, external safety measures must be provided to ensure safety in the system.

- When the 24-VDC output (service power supply to the PLC) is overloaded or short-circuited, the voltage may drop and result in the outputs being turned OFF. As a countermeasure for such problems, external safety measures must be provided to ensure safety in the system.

 **WARNING** Do not apply a voltage or current outside the specified range to this Unit. Doing so may result in malfunction or fire.

 **Caution** When wiring crossovers between terminals, the total current for both terminals will flow in the line. Check the current capacities of all wires before wiring crossovers.

 **Caution** Tighten the screws on the terminal block of the AC Power Supply Unit to the torque specified in the operation manual. The loose screws may result in burning or malfunction.

 **Caution** Execute online edit only after confirming that no adverse effects will be caused by extending the cycle time. Otherwise, the input signals may not be readable.

4 Operating Environment Precautions

 **Caution** Do not operate the control system in the following places:

- Locations subject to direct sunlight.
- Locations subject to temperatures or humidity outside the range specified in the specifications.
- Locations subject to condensation as the result of severe changes in temperature.
- Locations subject to corrosive or flammable gases.
- Locations subject to dust (especially iron dust) or salts.
- Locations subject to exposure to water, oil, or chemicals.
- Locations subject to shock or vibration.

 **Caution** Take appropriate and sufficient countermeasures when installing systems in the following locations:

- Locations subject to static electricity or other forms of noise.
- Locations subject to strong electromagnetic fields.
- Locations subject to possible exposure to radioactivity.
- Locations close to power supplies.

5 Application Precautions

Observe the following precautions when using the PLC.

 **WARNING** Always heed these precautions. Failure to abide by the following precautions could lead to serious or possibly fatal injury.

- Always connect to a class-3 ground (to 100 Ω or less) when installing the Units. Not connecting to a class-3 ground may result in electric shock.
- Always turn OFF the power supply to the PLC before attempting any of the following. Not turning off the power supply may result in malfunction or electric shock.
 - Mounting or dismounting I/O Units, CPU Units, Memory Cassettes, or any other Units.
 - Assembling the Units.
 - Setting DIP switch or rotary switches.
 - Connecting or wiring the cables.

 **Caution** Failure to abide by the following precautions could lead to faulty operation of the PLC or the system, or could damage the PLC or PLC Units. Always heed these precautions.

- Fail-safe measures must be taken by the customer to ensure safety in the event of incorrect, missing, or abnormal signals caused by broken signal lines, momentary power interruptions, or other causes.
- Always use the power supply voltage specified in this manual. An incorrect voltage may result in malfunction or burning.
- Take appropriate measures to ensure that the specified power with the rated voltage and frequency is supplied. Be particularly careful in places where the power supply is unstable. An incorrect power supply may result in malfunction.
- Install external breakers and take other safety measures against short-circuiting in external wiring. Insufficient safety measures against short-circuiting may result in burning.
- Do not apply voltages to input sections in excess of the rated input voltage. Excess voltages may result in burning.
- Do not apply voltages or connect loads in excess of the maximum switching capacity to output sections. Excess voltage or loads may result in burning.
- Be sure that all the mounting screws, terminal screws, and cable connector screws are tightened to the torque specified in the relevant manuals. Incorrect tightening torque may result in malfunction.
- Wiring correctly, as indicated in this manual.
- Do not attempt to disassemble, repair, or modify any Units.
- Be sure to confirm that the DIP switch and the data memory (DM) are properly set.
- Leave the label attached to the Unit when wiring. Removing the label may result in malfunction.
- Remove the labels after the completion of wiring to ensure proper heat dissipation. Leaving the label attached may result in malfunction.

- Use crimp terminals for wiring. Do not connect bare stranded wires directly to terminals. Connection of bare stranded wires may result in burning.
- Do not pull on cables and cords and do not bend them past their natural bending radius.
- Do not place any heavy objects on cables or cords.
- Mount the Unit only after checking the terminal block completely.
- Be sure that the terminal blocks, Memory Units, expansion cables, and other items with locking devices are properly locked into place. Improper locking may result in malfunction.
- Check the user program for proper execution before actually running it on the Unit. Not checking the program may result in an unexpected operation.
- Double-check all the wiring before turning on the power supply. Incorrect wiring may result in burning.
- Confirm that no adverse effect will occur in the system before attempting any of the following. Not doing so may result in an unexpected operation.
 - Changing the operating mode of the PLC (including the setting of the startup operating mode).
 - Force-setting/force-resetting any bit in memory.
 - Changing the present value of any word or any set value in memory.
- Touch a grounded metal object to discharge static electricity from your body before touching any Unit.
- The following precautions apply to Power Supply Units with Replacement Notification.
 - When the LED display on the front of the Power Supply Unit starts to alternately display “0.0” and “A02” or the alarm output automatically turns OFF, replace the Power Supply Unit within 6 months.
 - Separate the alarm output cables from power lines and high-voltage lines.
 - Do not apply a voltage or connect a load to the alarm output that exceeds the rated voltage or load.
 - Maintain an ambient storage temperature of –20 to 30°C and humidity of 25% to 70% when storing the product for longer than 3 months to keep the replacement notification function in optimum working condition.
 - Always use the standard installation method. A nonstandard installation will decrease heat dissipation, delay the replacement notification signal, and may degrade or damage the internal elements.
- This product is EMC compliant when assembled in a complete PLC system of the specified PLC Series. Refer to the applicable manual for grounding, cable selection, and any other conditions for EMC compliance.
- This is a class A product. In residential areas it may cause radio interference, in which case the user may be required to take adequate measures to reduce interference.

6 Conformance to EC Directives

Applicable Directives

- EMC Directives
- Low Voltage Directive

Concepts

■ EMC Directives

OMRON supplies electric devices that are used built into other devices or manufacturing equipment. These OMRON products are designed to conform to the related EMC standards (see note) so that the devices or equipment in which they are used can more easily conform to EMC standards.

EMC-related performance of the OMRON devices that conform to EC Directives will vary depending on the configuration, wiring, and other conditions of the equipment or control panel on which the OMRON devices are installed. The customer must, therefore, perform the final check to confirm that devices and the overall machine conform to EMC standards.

Note Applicable EMC (Electromagnetic Compatibility) standards are as follows:

EMS (Electromagnetic Susceptibility)

EN 61000-6-2

EMI (Electromagnetic Interference)

EN 61000-6-4 (Radiated emission: 10-m regulations)

■ Low Voltage Directive

Always ensure that devices operating at voltages of 50 to 1,000 V AC and 75 to 1,500 V DC meet the required safety standards for the PLC (EN 61131-2.)

CJ-series products conform to EC Directives. However, the following precautions must be observed to ensure that the machine or device in which the CJ-series PLC is used conforms to EC Directives:

1. The CJ-series PLC must be installed within a control panel.
2. You must use reinforced insulation or double insulation for the DC power supplies used for the I/O power supplies. The DC power supply connected to the power supply terminals on PLCs using DC power must have an output hold time of at least 10 ms.
3. CJ-series products conforming to EC Directives also conform to EN 61000-6-4 for EMI. Radiated emission characteristics (10-m regulations) may vary depending on the configuration of the control panel used, other devices connected to the control panel, wiring, and other conditions. You must therefore confirm that the overall machine or equipment conforms to EC Directives even when using CJ-series products that conform to EC Directives.

Conformance to EC Directives

SECTION 1

Features and System Configuration

This section introduces the features and primary functions, describes the system configuration, and outlines the operating procedure.

1-1	Features and Functions	2
1-2	System Configuration	5
1-3	Operating Procedure	7
1-4	Functions Listed by Purpose	7

1-1 Features and Functions

This section introduces the features and primary functions of the CJ-series CJ1W-AD04U and CJ1W-AD04U-SL Universal Input Units.

Four Input Channels

The CJ1W-AD04U and CJ1W-AD04U-SL Universal Input Units are CJ-series Special I/O Units with four input channels on each Unit. Each input channel can be set independently to one of four input types: DC voltage, DC current, thermocouple, or resistance thermometer.

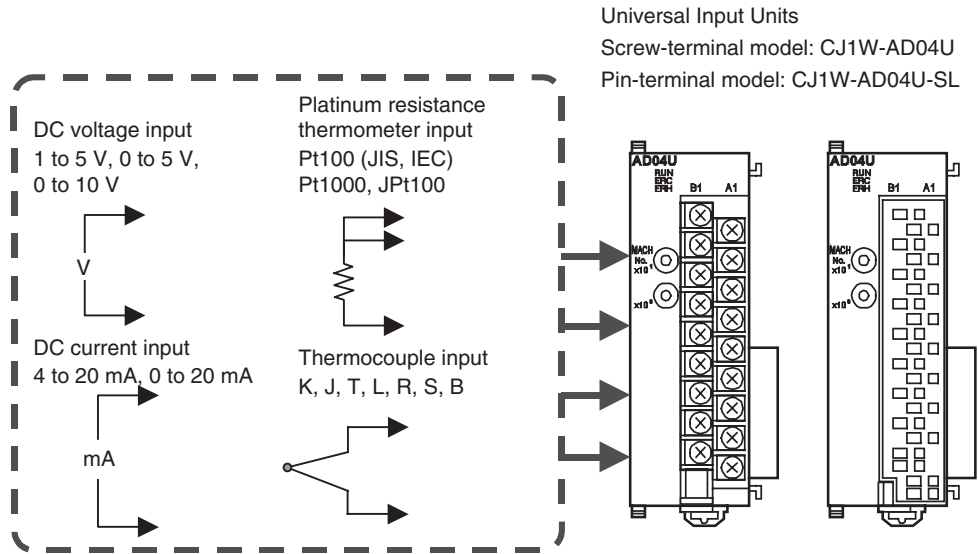

Isolation between Channels

The input channels are isolated in the Universal Input Unit, so unwanted current paths will not occur between thermocouple inputs or voltage inputs that share the same power supply. Signal converters are not needed to prevent interference between inputs.

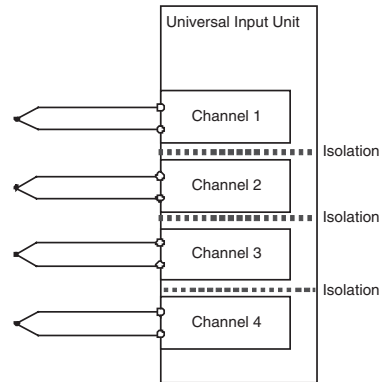

Scaling Function

This function takes the value scaled in industrial units with respect to the input signal and transfers it to the CPU Unit as the process value. Because of this, no ladder program is required at the CPU Unit for scaling.

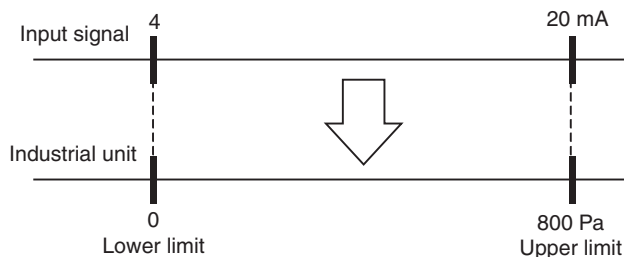

Process Value Alarms

Two process values can be set as alarm outputs (high and low alarms). Also, an alarm notification can be passed directly to an output device by using the Expansion Settings Area.

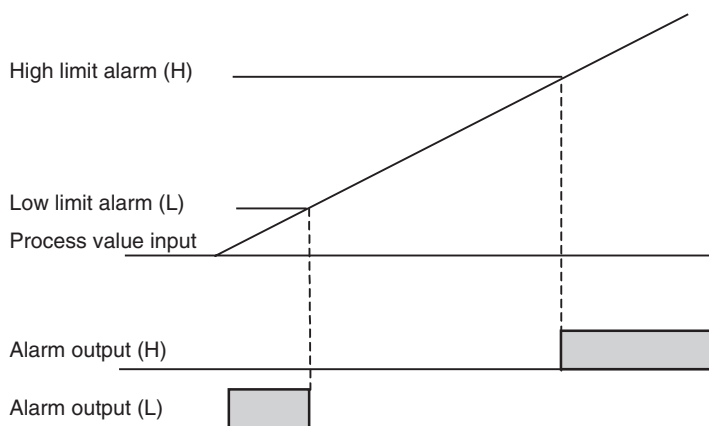

Alarm Hysteresis Settings

The hysteresis values can be set for the process value alarms. Frequent ON/OFF switching of the alarm output can be eliminated by setting a dead zone between the alarm output's start and stop.

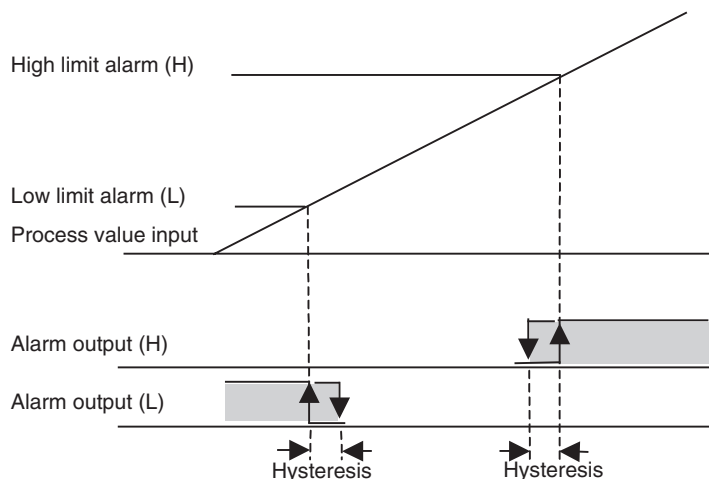

Alarm Output ON Delay

A fixed time delay can be set before the output starts for an alarm output (high or low limit). The ON delay can be set between 0 and 60 s. Each channel's ON delay is set independently, but the same ON delay applies to the channel's high and low limit alarms.

The following example shows the operation of the high limit alarm output.

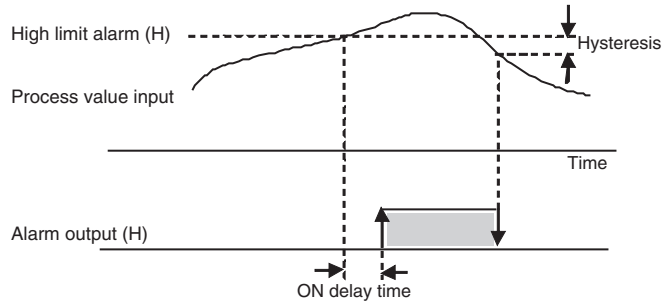

Input Error Detection

An error input can be detected if the input signal significantly exceeds the high or low limit.

Note With thermocouple and platinum resistance thermometer inputs, an input error is detected if the temperature exceeds the high or low limit of the sensor range by 20°C or 20°F.

With voltage and current inputs, an error is detected only for the following values in the 1 to 5 V and 4 to 20 mA ranges:

- 1 to 5 V range: Converted AD value < 0.3 V
- 4 to 20 mA range: Converted AD value < 1.2 mA

Either the high or low direction can be specified for the detection of a disconnection.

The allowable range limits are as follows:

- Temperature Input
 - Upper limit: Upper limit of temperature range +20°C or +20°F
 - Lower limit: Lower limit of temperature range -20°C or -20°F
- Voltage/Current Input
 - Upper limit: 105%
 - Lower limit: -5%

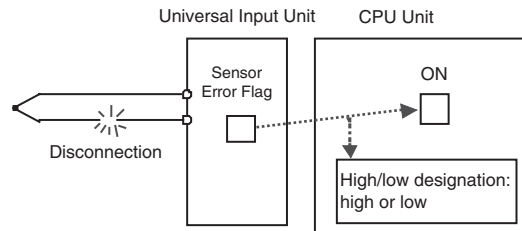

Note Sensor error detection is effective only when the input type is set to thermocouple input, platinum resistance thermometer input, 1 to 5 V input, or 4 to 20 mA input. The Sensor Error Flag will be turned ON if there is no input signal from the thermocouple input, platinum resistance thermometer input, 1 to 5 V input, or 4 to 20 mA input.

Detection of Cold Junction Sensor Errors

If the Unit's built-in cold junction sensor fails, the Cold Junction Sensor Error Flag will be turned ON to indicate the error.

Zero/Span Adjustment

The zero point and span point can be adjusted for a process value.

The zero adjustment offsets the line plotting values before and after adjustment parallel to the original line. The span adjustment changes the slope of the line (i.e., the gain) around the minimum value in the range.

The zero adjustment value and the span adjustment gain are set in the DM Area words allocated in the CPU Unit. These settings are refreshed during operation, so the values can be adjusted under normal operating conditions. Refer to 4-2-3 Zero/Span Adjustment for details.

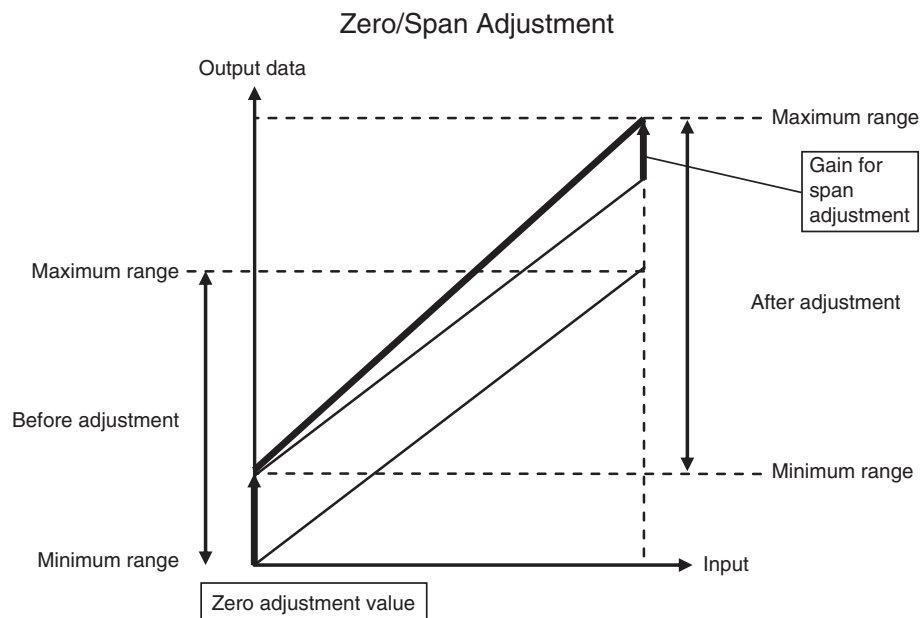

1-2 System Configuration

Basic Configuration

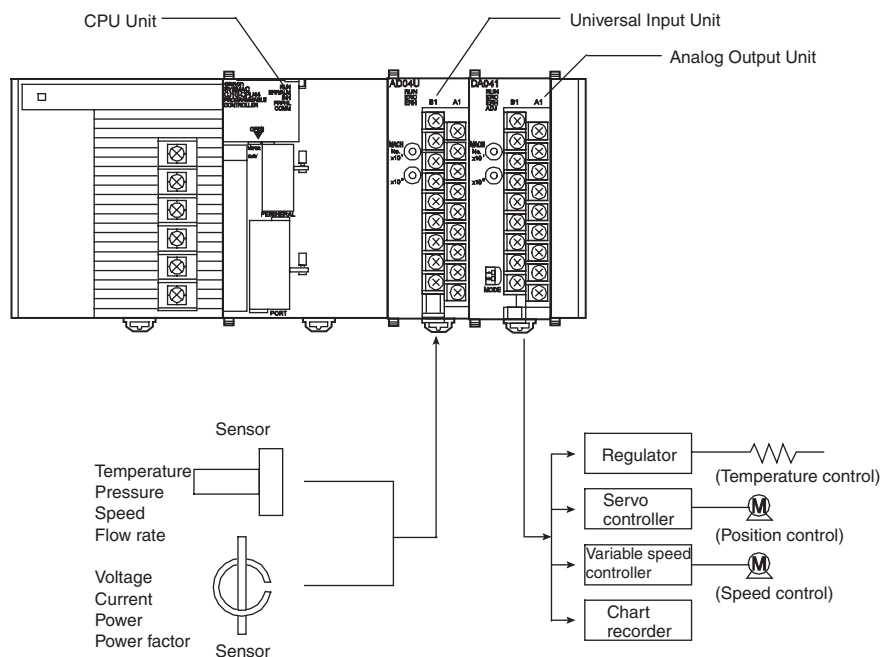

Note The above diagram is an installation example for a CJ1W-AD04U and CJ1W-AD04U-SL Universal Input Unit and CJ1W-DA041 Analog Output Unit.

Mounting Restrictions

The CJ1W-AD04U and CJ1W-AD04U-SL Universal Input Units are CJ-series Special I/O Units. The following restrictions apply to the mounting location and number of a mounted Universal Input Units.

- The Universal Input Unit can be mounted only in a CJ-series CPU Rack or CJ-series Expansion Rack.
- The number of Universal Input Units that can be mounted to one Rack (i.e., a CPU Rack or Expansion Rack) depends on the capacity of the Power Supply Unit and the current consumption of other Units in the Rack. The following table shows the maximum number of Units that can be mounted if only Universal Input Units are mounted.

Power Supply Unit	Rack	CJ1W-AD04U CJ1W-AD04U-SL (5 V DC 320 mA)
CJ1W-PA205R CJ1W-PA205C CJ1W-PD025 (5.0 A at 5 V DC)	CPU Rack	9
	Expansion Rack	10
CJ1W-PA202 (2.8 A at 5 V DC)	CPU Rack	4
	Expansion Rack	7
CJ1W-PD022 (2.0 A at 5 V DC)	CPU Rack	2
	Expansion Rack	5

Note I/O words are allocated to the Special I/O Unit according to the setting of the unit number switch on the front panel of the Unit, and not the slot number where the Unit is mounted.

1-3 Operating Procedure

Follow the procedure outlined below when using a Universal Input Unit.

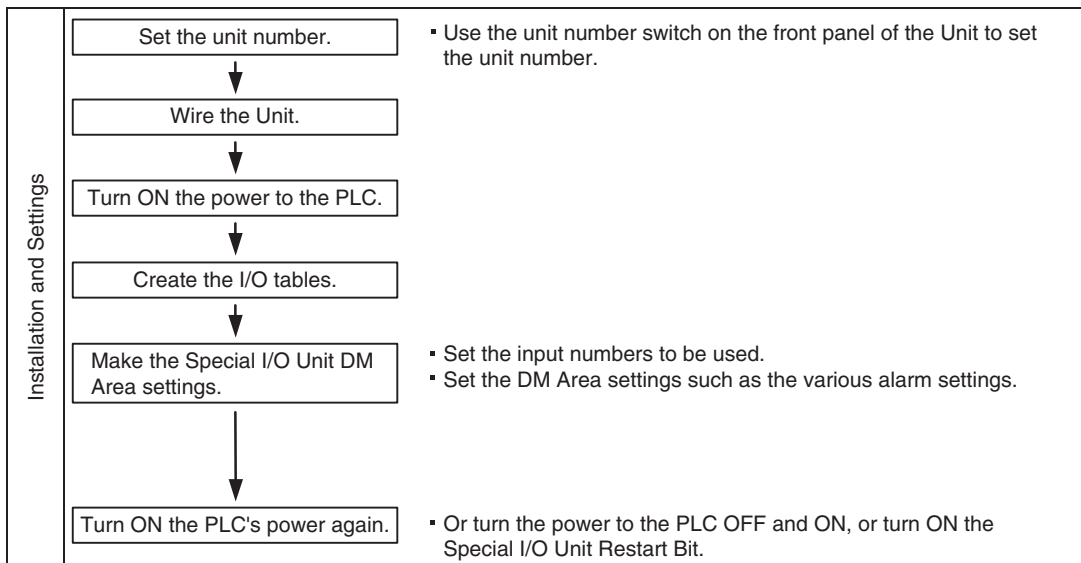

(Perform the following steps when inputs must be adjusted for the connected devices.)

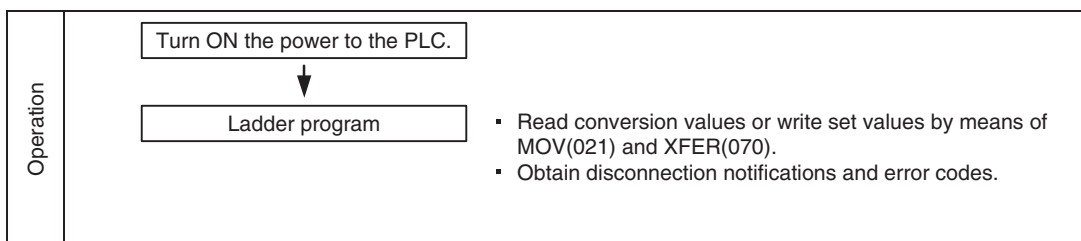
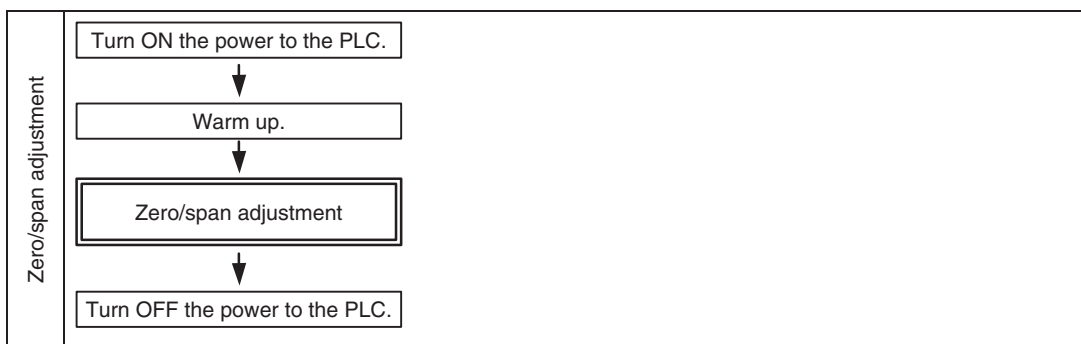

1-4 Functions Listed by Purpose

Purpose	Function	Page
Displaying the input signal level in actual units	Scaling function	P. 35
Generating an alarm when the process value exceeds a low or high limit	Process value alarm	P. 37
Preventing the alarm output from being output too often if the process value crosses the high or low limit (H or L) frequently.	Alarm hysteresis setting	P. 38
	Alarm ON delay	P. 38
Detecting a disconnected input signal	Sensor error detection function	P. 36

Purpose	Function	Page
Adjusting the zero and span settings for particular I/O devices	Zero/span adjustment	P. 34
Outputting a high or low alarm without ladder programming	Expansion Setting Area settings	P. 39
Obtaining a process value with a negative gain	Process value scaling with negative gain	P. 53
Identifying the causes of errors	Error processing	P. 43

SECTION 2

Specifications and Component Names

This section describes the specifications, component names, and switch settings of the CJ1W-AD04U and CJ1W-AD04U-SL Universal Input Units.

2-1	Specifications	10
2-2	Input Types and Data Conversion	12
2-3	Nomenclature and Functions	15

2-1 Specifications

Specifications

Items	Unit type	CJ1W-AD04U Screw terminal model	CJ1W-AD04U-SL Screwless terminal model
External connection terminals		18-point removable terminal block (M3 screws)	18-point removable terminal block (Screwless spring-clamp type)
Unit classification		CJ-series Special I/O Unit	
Isolation (See note 1.)		Between inputs and PLC signals: Transformer isolation of power supply and photocoupler isolation of signals Between inputs: Transformer isolation of power supply and photocoupler isolation of signals	
Effect on CPU Unit cycle time		0.2 ms	
Power consumption		320 mA max. at 5 VDC	
Dimensions (See note 2.)		31 × 90 × 65 mm (W × H × D)	
Weight		140 g max.	
General specifications		Conforms to general specifications for SYSMAC CJ Series.	
Mounting position		CJ-series CPU Rack or CJ1-series Expansion Rack	
Maximum number of Units (See note 3.)		4 to 10 Units per Rack	
Data exchange with CPU Units (See note 4.)		Special I/O Unit Area in CIO Area (CIO 2000 to CIO 2959): 10 words per Unit Special I/O Unit words in DM Area (D20000 to D29599): 100 words per Unit	

- Note**
- Do not apply a voltage higher than 600 V to the terminal block when performing withstand voltage test on this Unit. Otherwise, internal elements may deteriorate.
 - Refer to *Dimensions* on page 49 for details on the Unit's dimensions.
 - The following table is for a Rack containing only Universal Input Units. When other Units are mounted, the maximum number of Universal Input Units may be lower, depending on the current consumption of the other Units mounted in the Rack.

Power Supply Unit	Rack	CJ1W-AD04U CJ1W-AD04U-SL
CJ1W-PA205R CJ1W-PA205C CJ1W-PD025 (5.0 A at 5 VDC)	CPU Rack	9
	Expansion Rack	10
CJ1W-PA202 (2.8 A at 5 VDC)	CPU Rack	4
	Expansion Rack	7
CJ1W-PD022 (2.0 A at 5 VDC)	CPU Rack	2
	Expansion Rack	5

- I/O words are allocated to the Special I/O Unit according to the setting of the unit number switch on the front panel of the Unit, and not the slot number where the Unit is mounted.

- Data Exchange with the CPU Unit (For details, refer to *SECTION 4 Input Functions and Operating Procedures.*)

Special I/O Unit Area in CIO Area (CIO 2000 to CIO 2959, CIO 2000.00 to CIO 2959.15)	Regularly exchanges 10 words per Unit. (CPU Unit ↔ Universal Input Unit)
Special I/O Unit words in DM Area (D20000 to D29599)	Transfers 100 words of data per Unit. The following data is transferred at the indicated time. <ul style="list-style-type: none"> • Initial settings data: Transferred when power is turned ON or the Unit is restarted. • Continuously refreshed data (e.g., alarm settings): Transferred during I/O refresh period. • Expansion Setting Area: Transferred during the I/O refresh period. (CPU Unit ↔ Universal Input Unit)

Input Specifications

Items	Specifications
Number of analog inputs	4
Input type (See note 1.)	<ul style="list-style-type: none"> • Platinum resistance thermometer: Pt100 (JIS, IEC), PT1000, or JPt100 • Thermocouple: K, J, T, L, R, S, or B • Current: 4 to 20 mA, or 0 to 20 mA • Voltage: 1 to 5 V, 0 to 5 V, or 0 to 10 V Each input can be set independently.
Maximum rated input (See note 2.)	Voltage Input: ±15 V Current Input: ±30 mA
Input impedance	Temperature: 10 kΩ min. Voltage Input: 1 MΩ min. Current Input: 250 Ω (rated value)
Resolution	12,000 (for voltage or current input)
Converted output data	16-bit binary data
Accuracy (25°C) (These values do not include the sensor error.)	Typical thermocouple inputs: (±0.3% of PV or ±1.5°C, whichever is greater) ±1 digit max. Special cases: <ul style="list-style-type: none"> • The accuracy of L is ±2°C ±1 digit max. • The accuracy of K and T at -100°C or less is ±2°C ±1 digit max. • The accuracy of R and S at 200°C or less is ±3°C ±1 digit max. • The accuracy of B at 400°C or less is not specified. Platinum resistance thermometers: (±0.3% of PV or ±0.8°C, whichever is greater) ±1 digit max. Voltage inputs and current inputs: (±0.3% FS) ±1 digit max.
Temperature coefficient	+/-100 ppm FS/°C max.
Warm-up time	30 min
A/D conversion time (See note 3.)	250 ms/4 inputs

Items	Specifications
Measurement method for platinum resistance thermometer inputs	3-wire method
Allowable lead wire resistance	20 Ω max. per wire

- Note**
1. Input signal ranges can be set for each input.
 2. Use the analog input voltage/current value within the specified input signal-range. Exceeding the specified range may result in malfunction.
 3. A/D conversion time is the time it takes for an analog signal to be stored in memory as converted data after it has been input. It takes at least one cycle before the converted data is read by the CPU Unit.

Input Conversion and Alarm Output Functions

Item	Specifications
Process value alarms	Two alarms (high and low) with hysteresis. The alarms can be set separately for each input.
ON-delay timer	0 to 60 s, independently settable for each input
Scaling (Voltage and current inputs)	Any industrial units can be set by setting the upper and lower limits in the range of $-32,000$ to $32,000$. These limits are converted as full scale. Each input can be set independently.
Zero/span adjustment	<ul style="list-style-type: none"> • Zero adjustment (offset) range: $\pm 9,999$ (LSB) • Span adjustment (gain) range: 0 to $32,000$ ($\times 0.0001$) Each input can be set independently.
Sensor error detection	Detects sensor error at each input and turns ON the Sensor Error Flag. (See note.)
Cold junction sensor error	Detects errors in the cold junction sensor. and turns ON the Cold Junction Sensor Error Flag.

- Note** Sensor error detection is effective only when the input type is set to thermocouple input, platinum resistance thermometer input, 1 to 5 V input, or 4 to 20 mA input. The Sensor Error Flag will be turned ON if there is no input signal from the thermocouple input, platinum resistance thermometer input, 1 to 5 V input, or 4 to 20 mA input.

2-2 Input Types and Data Conversion

In addition to voltage and current inputs, the temperature sensors listed below can be connected directly to a Universal Input Unit.

Voltage and Current Inputs

Voltage/current input	DM Area setting	
Voltage input (DC)	1 to 5 V	0050 (0032 hex)
	0 to 5 V	0053 (0035 hex)
	0 to 10 V	0054 (0036 hex)
Current input (DC)	4 to 20 mA	0048 (0030 hex)
	0 to 20 mA	0049 (0031 hex)

Temperature Inputs

Sensor type		DM Area setting	Measurable input range	
			°C	°F
Resistance thermometers	Pt100	0 (0000 hex)	-200.0 to 650.0	-300.0 to 1200.0
	JPt100	3 (0003 hex)	-200.0 to 650.0	-300.0 to 1200.0
	Pt1000	7 (0007 hex)	-200.0 to 650.0	-300.0 to 1200.0
Thermocouples	K	21 (0015 hex)	-200.0 to 1300.0	-300.0 to 2300.0
	J	23 (0017 hex)	-100.0 to 850.0	-100.0 to 1500.0
	T	25 (0019 hex)	-200.0 to 400.0	-300.0 to 700.0
	L	33 (0021 hex)	-100.0 to 850.0	-100.0 to 1500.0
	R	36 (0024 hex)	0.0 to 1700.0	0.0 to 3000.0
	S	37 (0025 hex)	0.0 to 1700.0	0.0 to 3000.0
	B	38 (0026 hex)	100.0 to 1800.0	300.0 to 3200.0

The measured temperature error is calculated as shown in the following example.

Example:

Item	Details
Ambient temperature	30°C
Thermocouple type	K
Measured temperature (PV)	500°C
Reference accuracy (25°C)	±0.3°C of PV or ±1.5°C, whichever is greater, ±1 digit. In this example, ±1.5°C
Temperature characteristics	When the coefficient is ±100 ppm FS/°C, the characteristic in this example is 100 ppm × 1300°C = 0.13°C
Change in ambient temperature	25°C → 30°C = 5°C

Overall accuracy =
Reference accuracy + Temperature characteristic × Change in ambient temperature = ±1.5°C + (±0.13°C) × 5°C = ±2.2°C ±1 digit.

Input Function Block Diagram

The following calculations can be performed in series on the converted process value, and the resulting value can be transferred to the CPU Unit as the converted value. Since the adjustments are performed in the Unit, there is no need to process the data in the CPU Unit's ladder program.

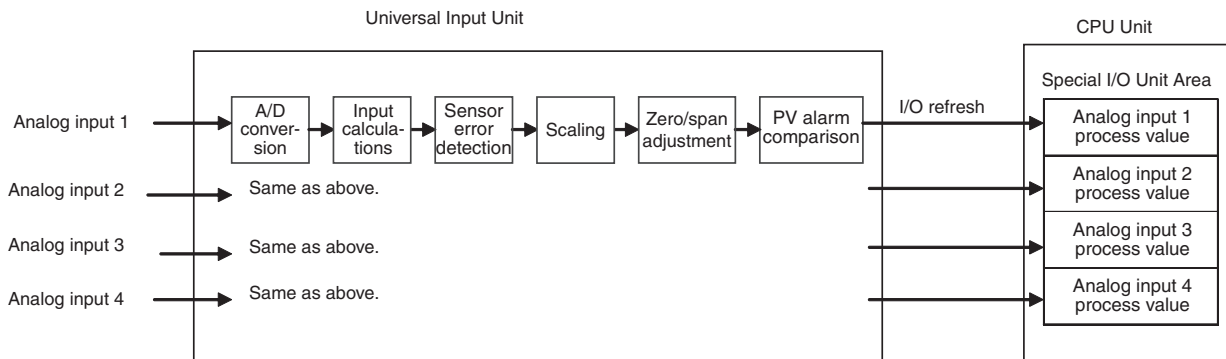

Internal Configuration

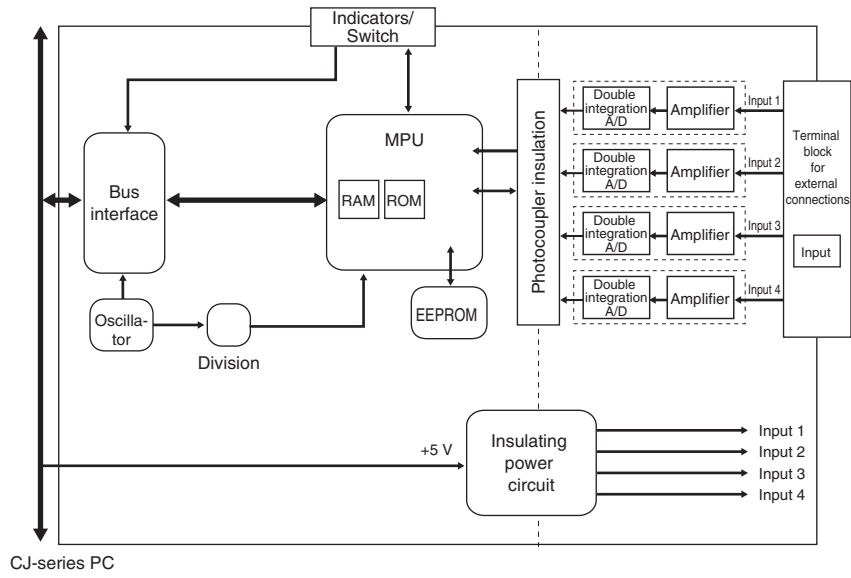

2-3 Nomenclature and Functions

Components

CJ1W-AD04U

CJ1W-AD04U-SL

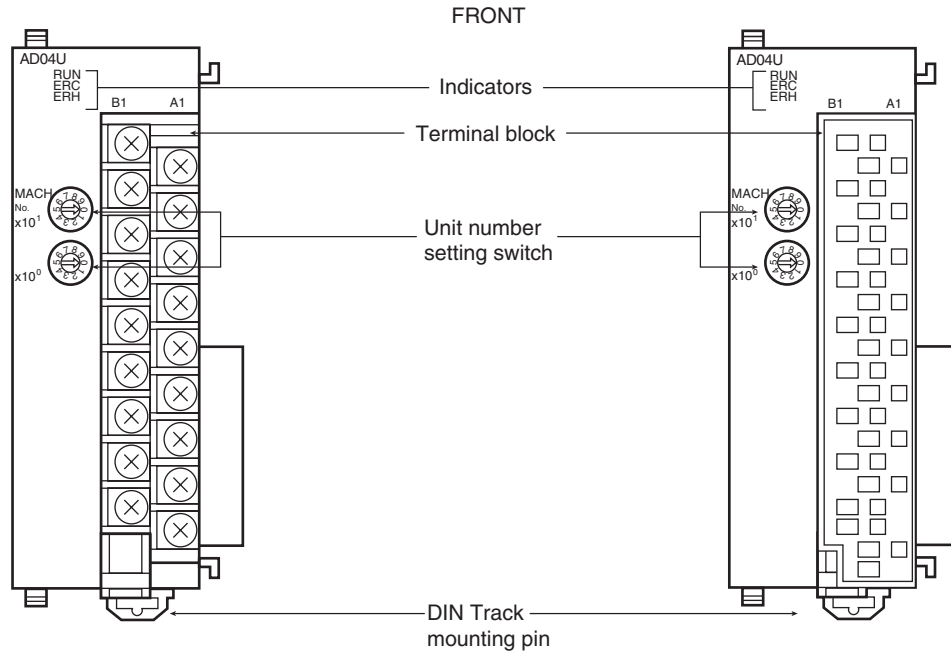

CJ1W-AD04U

CJ1W-AD04U-SL

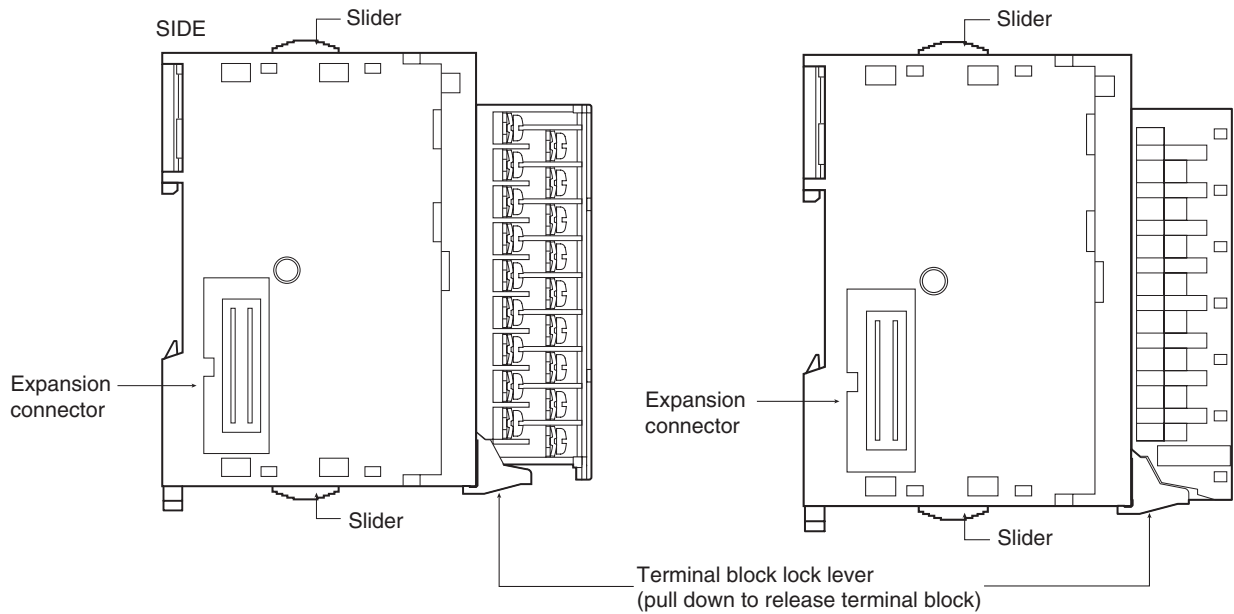

Indicators

The indicators show the operating status of the Unit. The following table shows the meanings of the indicators.

LED	Meaning	Indicator	Operating status
RUN (green)	Operating	Lit	Operating normally.
		Not lit	Unit has stopped exchanging data with the CPU Unit.
ERC (red)	Error detected by Unit	Lit	An alarm occurred (such as detection of a sensor error) or there is an incorrect setting in the DM Area settings.
		Not lit	Operating normally.
ERH (red)	Error in the CPU Unit	Lit	Error has occurred during data exchange with the CPU Unit.
		Not lit	Operating normally.

Unit Number Switch

The CPU Unit and Universal Input Unit exchange data via the Special I/O Unit Area and the Special I/O Unit words in the DM Area.

The Special I/O Unit Area word addresses and Special I/O Unit word addresses in the DM Area that each Universal Input Unit occupies are set by the unit number switch on the front panel of the Unit. Refer to page 26 for details on the unit number setting.

Unit number setting switches

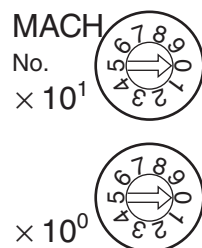

Note If two or more Special I/O Units are assigned the same unit number, a “UNIT No. DPL ERR” error (in the Programming Console) will be generated (A401.13 will turn ON) and the PLC will not operate.

The fatal error code, error contents, and time of occurrence are stored as an error record in the Auxiliary Area of the CPU Unit.

SECTION 3

Installation and Wiring

This section explains how to install and wire the CJ1W-AD04U and CJ1W-AD04U-SL Universal Input Units.

3-1	Installing the Units	18
3-2	Wiring	19

3-1 Installing the Units

Mount the Universal Input Unit in a CJ-series CPU Rack or Expansion Rack.

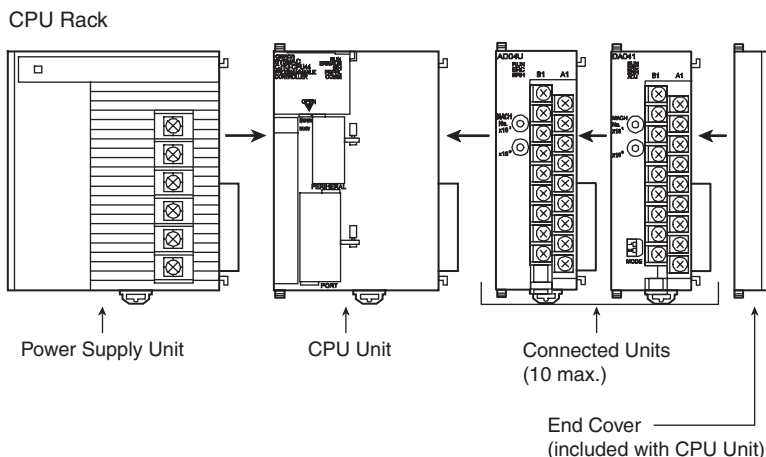

Use the following procedure to mount the Units.

- 1,2,3...**
1. Align the connectors and press in firmly on the Units to connect them completely.

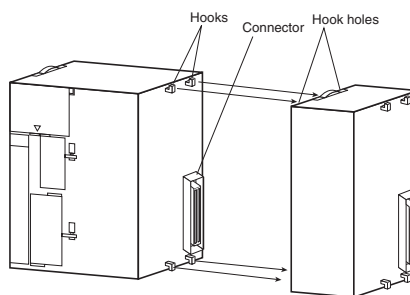

2. Move the yellow sliders on the top and bottom of the Unit to the lock position to secure the Units. The sliders should click into place.

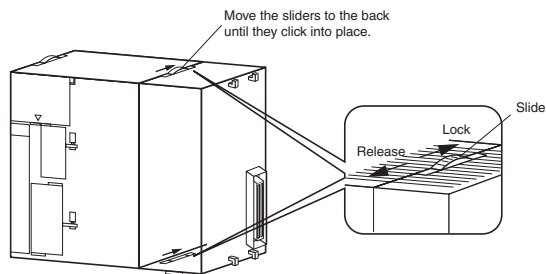

3. Attach an End Cover to the Unit on the right end of the Rack.

- Note**
- The CJ-series PLC may not operate properly if the sliders are not locked firmly into place.
 - Always mount an End Cover.

Handling Precautions

- Be sure to turn OFF the power supply to the PLC before installing or disconnecting Units or wiring.
- To reduce the risk of malfunctioning due to electrical noise, wire input and output lines in separate ducts from high-voltage and power lines.

- When wiring a Unit, leave the protective label on the top of the Unit in place to prevent wire clippings or other materials from getting inside the Unit. When the wiring has been completed, the label must be removed to allow air to flow for cooling.

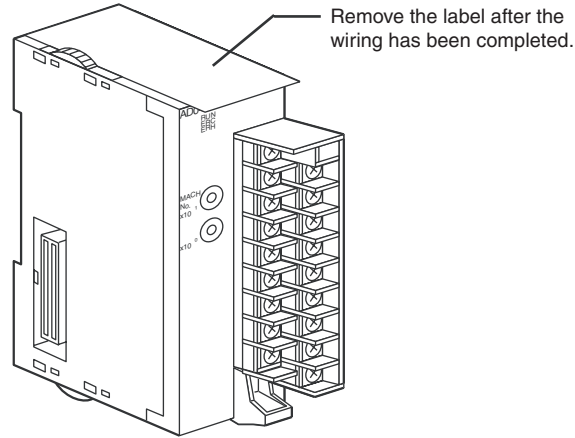

3-2 Wiring

Terminal Arrangement

The following diagram shows the signal names associated with the connecting terminals.

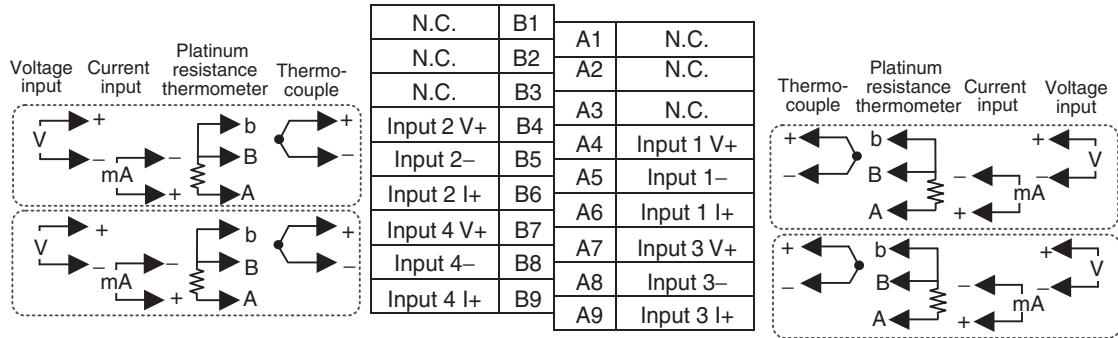

The Universal Input Units have 4 input channels on each Unit, and the type of input connected to each channel can be set independently.

Wiring Analog Inputs

Ground the shield of the shielded cable to protect against the affects of noise.

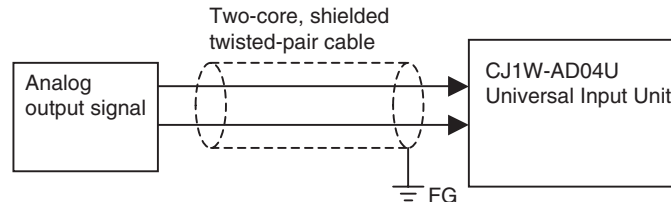

- Note**
1. Be sure to wire the correct terminals when wiring voltage inputs. The Unit may fail if a voltage input is wired incorrectly.
 2. Do not connect anything to terminals that are not being used.
 3. Do not connect anything to NC terminals. Do not use NC terminals as relay terminals.

4. Wire the same lengths to A, B, and b so that the impedance will be the same. In particular, do not short circuit between B and b at the terminal block.
5. Always ground the GR terminal on the Power Supply Unit of the PLC.
6. If the input device uses a voltage generator, temperature compensator, or similar device, ground the input device if it has a ground terminal.
7. The cold junction compensators are individually calibrated for each Unit and each input circuit. If the terminal block from a different Unit is used, temperature measurements will not be accurate. Always use the terminal block that is delivered with the Unit.

Wiring a Screw Terminal Block (CJ1W-AD04U)

- Crimp-type terminals must be used for terminal connections, and the screws must be tightened securely. Use M3 screws and tighten them to a torque of 0.5 N·m.
- Do not make any connections to the N.C. terminals.

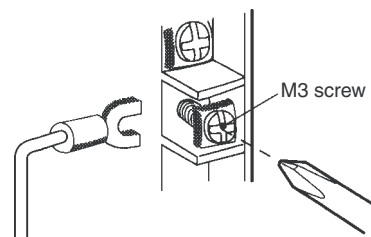

- Recommended crimp terminals



Terminal Block Arrangement

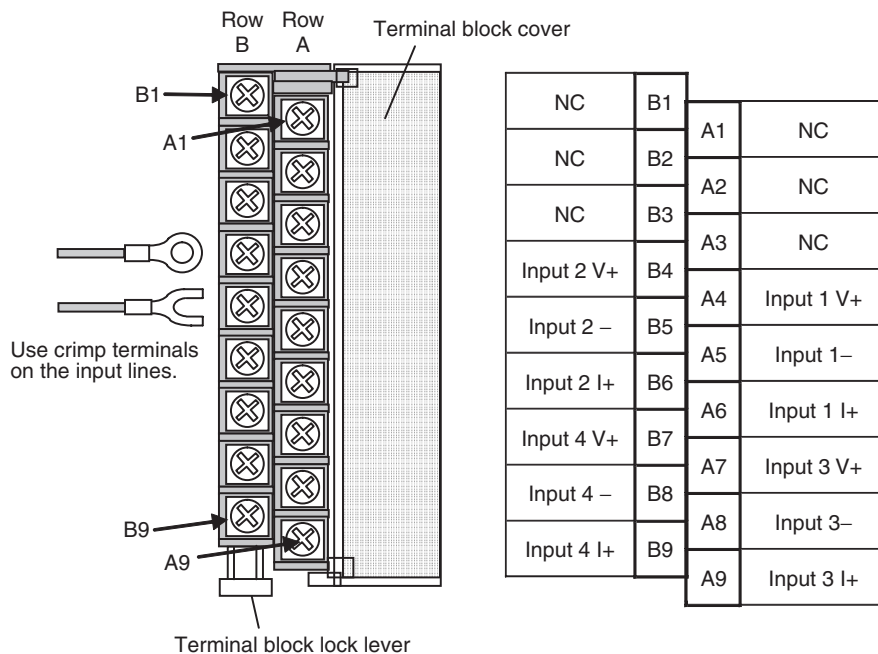

Wiring a Screwless Clamp Terminal Block (CJ1W-AD04U-SL)

Terminal Block Arrangement

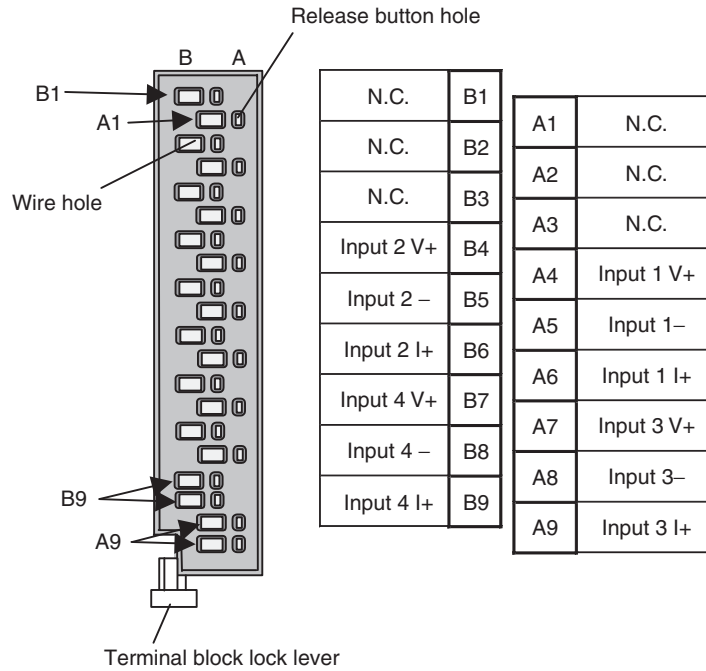

- Strip about 10 mm of the insulation from the end of the wire and insert the bare wire or attach a pin terminal.
- If bare stranded wire is used without a pin terminal, be sure that there are no loose wire strands that may contact another circuit.

Connecting the Wires

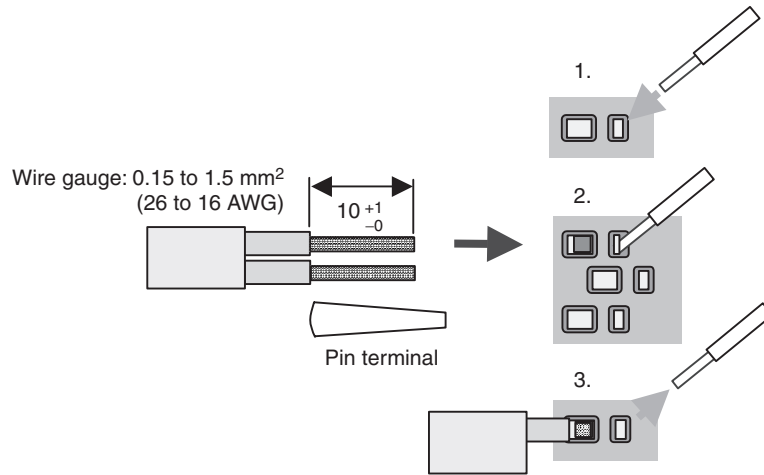

- 1,2,3...**
1. Use stranded or solid wire. Pin terminals can also be used. Insert a precision screwdriver in the release button hole.
 2. When the screwdriver is pushed firmly to the bottom, the lock will be released and it will be possible to insert the wire into the wire hole.
 3. Insert the wire fully into the wire hole (but without any of the wire insulation in the wire hole) and pull out the screwdriver to lock the wire in place.

Recommended Components

- The following screwdriver can be used when inserting and removing wires.

Recommended screwdriver

Model number	Manufacturer
SD 0.4 × 2.5 × 75	Weidmuller

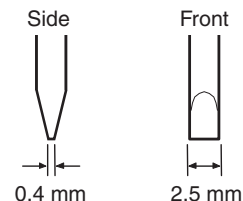

- Recommended pin terminals and crimp tool

Manufacturer	Model number	Compatible wire	Crimp tool
Weidmuller	H 0.5/16 D	0.5 mm ² (20AWG)	PZ 6/5
	H 0.75/16 D	0.75 mm ² (18AWG)	
	H 1.5/16 D	1.25 mm ² (16AWG)	

- Contact information for other companies

Allen-Bradley: www.ab.com

Phoenix Contact: www.phoenixcontact.com

Weidmuller: www.weidmuller.com

OMRON 24 Service (Japanese): www.omron24.co.jp

Input Wiring Precautions

Observe the following wiring precautions to optimize the Unit's functions and reduce the effects of noise.

- Use twisted-pair shielded wire for the input lines.
- Wire the input lines separately from power lines, such as AC power supply lines. Do not place input lines and power lines in the same duct.
- Install a noise filter at the power supply input if noise is entering from the power supply line, which may occur when the Unit is installed near high-frequency equipment or the power supply is shared with a electric welding machine or electric discharge machines.

SECTION 4

Input Functions and Operating Procedures

This section describes the input functions and operating procedures of the CJ1W-AD04U and CJ1W-AD04U-SL Universal Input Unit.

4-1	Exchanging Data with the CPU Unit	24
4-2	Detailed Description of User Settings Area Data	33
4-2-1	Input Type Setting	33
4-2-2	Temperature Unit Setting	33
4-2-3	Zero/Span Adjustment	34
4-2-4	Scaling Function Settings	35
4-2-5	Sensor Error (Disconnection) Detection and Operation	36
4-2-6	Process Value Alarm Settings	37
4-2-7	Alarm Hysteresis Settings	38
4-2-8	Alarm Output ON Delay Settings	38
4-2-9	Cold Junction Sensor Error Detection	39
4-2-10	Other Settings	39
4-3	Expansion Setting Area	39

4-1 Exchanging Data with the CPU Unit

Outline of Data Exchange

Data is exchanged between the CPU Unit and the CJ1W-AD04U and CJ1W-AD04U-SL Universal Input Units via the Special I/O Unit Area (for data used to operate the Unit) and the Special I/O Unit words in the DM Area (for data used for settings).

Operating Data

These CIO Area words contain the process values, alarm outputs, and flags such as the Sensor Error Flags. The words in the CPU Unit's Special I/O Unit Area are allocated by unit number.

Unit Settings

These DM Area words contain various Unit settings. The words allocated to the Unit in the DM Area are allocated by unit number.

The Unit settings are divided into the following 5 areas.

- Unit values read command
- Address of data range error
- Continuously refreshed area
- Initial settings area
- Expansion Setting Area settings

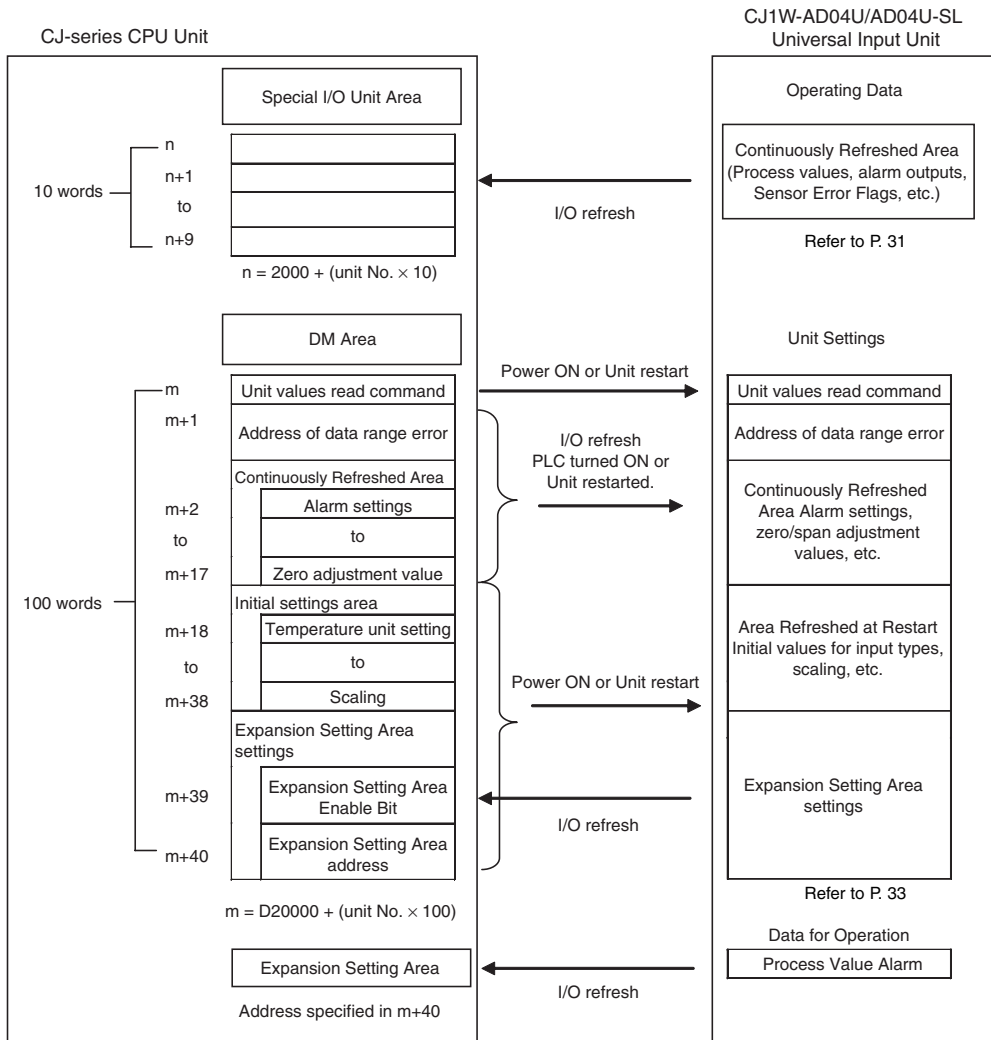

Contents of the Operating Data and Unit Settings Areas

The following functions are assigned to data in the CPU Unit's Special I/O Unit Area and Special I/O Unit words in the DM Area.

Data area	Function	Timing of data transfer
Operating Data	Contains operating data, including the process values, alarm outputs, and flags such as the Sensor Error Flags. The words are in the CPU Unit's Special I/O Unit Area (part of the CIO Area).	Cyclic (during I/O refreshing)
User Settings	The following settings are allocated in the Special I/O Unit words in the DM Area.	---
Unit values read command	Reads the Universal Input Unit initial data to the CPU Unit.	When power is turned ON or Unit is restarted
Address of data range error	Contains the address where out-of-range data was detected. (See note.)	
Continuously refreshed area	Contains settings such as the alarm hysteresis, alarm ON delay, and zero/span adjustment settings.	Cyclic (during I/O refreshing), when power is turned ON, or Unit is restarted.
Initial settings area	Sets initial Unit settings such as the input type and scaling settings.	When power is turned ON or Unit is restarted
Expansion Setting Area settings	Makes Expansion Setting Area settings.	

Note If an out-of-range setting is detected in either the continuously refreshed area or initial settings area, the ERC indicator on the Unit's front panel will light. The address of the first word containing an invalid setting is stored in the "address of data range error" word in four digits hexadecimal, as the offset from word m.

If the first out-of-range setting is in the Expansion Setting Area, the "address of data range error" offset will be +100 or higher (+100 if the first word in the Expansion Setting Area is invalid).

When the continuously refreshed area is changed, the ERC indicator will light and the address will be indicated in the "address of data range error." The next time that the power is turned ON or the Unit is restarted, the ERC indicator will light again and the corresponding out-of-range error address in the initial settings area will be displayed.

Unit Number Settings

The Special I/O Unit Area word addresses and the Special I/O Unit word addresses in the DM Area that each Universal Input Unit occupies are set by the unit number switch on the front panel of the Unit.

Unit number setting switches

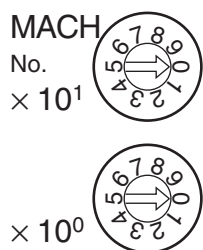

Switch setting	Unit number	Special/O Unit Area addresses	Special I/O Unit word addresses in DM Area
0	Unit #0	CIO 2000 to CIO 2009	D20000 to D20099
1	Unit #1	CIO 2010 to CIO 2019	D20100 to D20199
2	Unit #2	CIO 2020 to CIO 2029	D20200 to D20299
3	Unit #3	CIO 2030 to CIO 2039	D20300 to D20399
4	Unit #4	CIO 2040 to CIO 2049	D20400 to D20499
5	Unit #5	CIO 2050 to CIO 2059	D20500 to D20599
6	Unit #6	CIO 2060 to CIO 2069	D20600 to D20699
7	Unit #7	CIO 2070 to CIO 2079	D20700 to D20799
8	Unit #8	CIO 2080 to CIO 2089	D20800 to D20899
9	Unit #9	CIO 2090 to CIO 2099	D20900 to D20999
10	Unit #10	CIO 2100 to CIO 2109	D21000 to D21099
to	to	to	to
N	Unit #n	CIO 2000 + N × 10 to CIO 2000 + N × 10 + 9	D20000 + N × 100 to D20000 + N × 100 + 99
to	to	to	to
95	Unit #95	CIO 2950 to CIO2959	D29500 to D29599

Special I/O Unit Restart Bits

To restart the Unit operations after changing the contents of the data memory or correcting an error, turn ON the power to the PLC again or turn the Special I/O Unit Restart Bit ON and then OFF again.

Bits	Unit Number	Bits	Unit Number	Bits	Unit Number
A502.00	Unit #0	A503.00	Unit #16	A504.00	Unit #32
A502.01	Unit #1	A503.01	Unit #17	A504.01	Unit #33
A502.02	Unit #2	A503.02	Unit #18	A504.02	Unit #34
A502.03	Unit #3	A503.03	Unit #19	A504.03	Unit #35
A502.04	Unit #4	A503.04	Unit #20	A504.04	Unit #36
A502.05	Unit #5	A503.05	Unit #21	A504.05	Unit #37
A502.06	Unit #6	A503.06	Unit #22	A504.06	Unit #38
A502.07	Unit #7	A503.07	Unit #23	A504.07	Unit #39
A502.08	Unit #8	A503.08	Unit #24	A504.08	Unit #40
A502.09	Unit #9	A503.09	Unit #25	A504.09	Unit #41
A502.10	Unit #10	A503.10	Unit #26	A504.10	Unit #42
A502.11	Unit #11	A503.11	Unit #27	A504.11	Unit #43
A502.12	Unit #12	A503.12	Unit #28	A504.12	Unit #44
A502.13	Unit #13	A503.13	Unit #29	A504.13	Unit #45
A502.14	Unit #14	A503.14	Unit #30	A504.14	Unit #46
A502.15	Unit #15	A503.15	Unit #31	A504.15	Unit #47

Bits	Unit Number	Bits	Unit Number	Bits	Unit Number
A505.00	Unit #48	A506.00	Unit #64	A507.00	Unit #80
A505.01	Unit #49	A506.01	Unit #65	A507.01	Unit #81
A505.02	Unit #50	A506.02	Unit #66	A507.02	Unit #82
A505.03	Unit #51	A506.03	Unit #67	A507.03	Unit #83
A505.04	Unit #52	A506.04	Unit #68	A507.04	Unit #84
A505.05	Unit #53	A506.05	Unit #69	A507.05	Unit #85
A505.06	Unit #54	A506.06	Unit #70	A507.06	Unit #86
A505.07	Unit #55	A506.07	Unit #71	A507.07	Unit #87
A505.08	Unit #56	A506.08	Unit #72	A507.08	Unit #88
A505.09	Unit #57	A506.09	Unit #73	A507.09	Unit #89
A505.10	Unit #58	A506.10	Unit #74	A507.10	Unit #90
A505.11	Unit #59	A506.11	Unit #75	A507.11	Unit #91
A505.12	Unit #60	A506.12	Unit #76	A507.12	Unit #92
A505.13	Unit #61	A506.13	Unit #77	A507.13	Unit #93
A505.14	Unit #62	A506.14	Unit #78	A507.14	Unit #94
A505.15	Unit #63	A506.15	Unit #79	A507.15	Unit #95

Note If the error is not corrected by restarting the Unit or turning the Special I/O Unit Restart Bit ON and then OFF again, replace the Unit.

Data Allocation in the User Settings Area

DM Area

The Unit's various user settings are made in the Special I/O Unit words in the DM Area. Settings such as the alarm settings and span/zero adjustment values can be changed while the CPU Unit is operating.

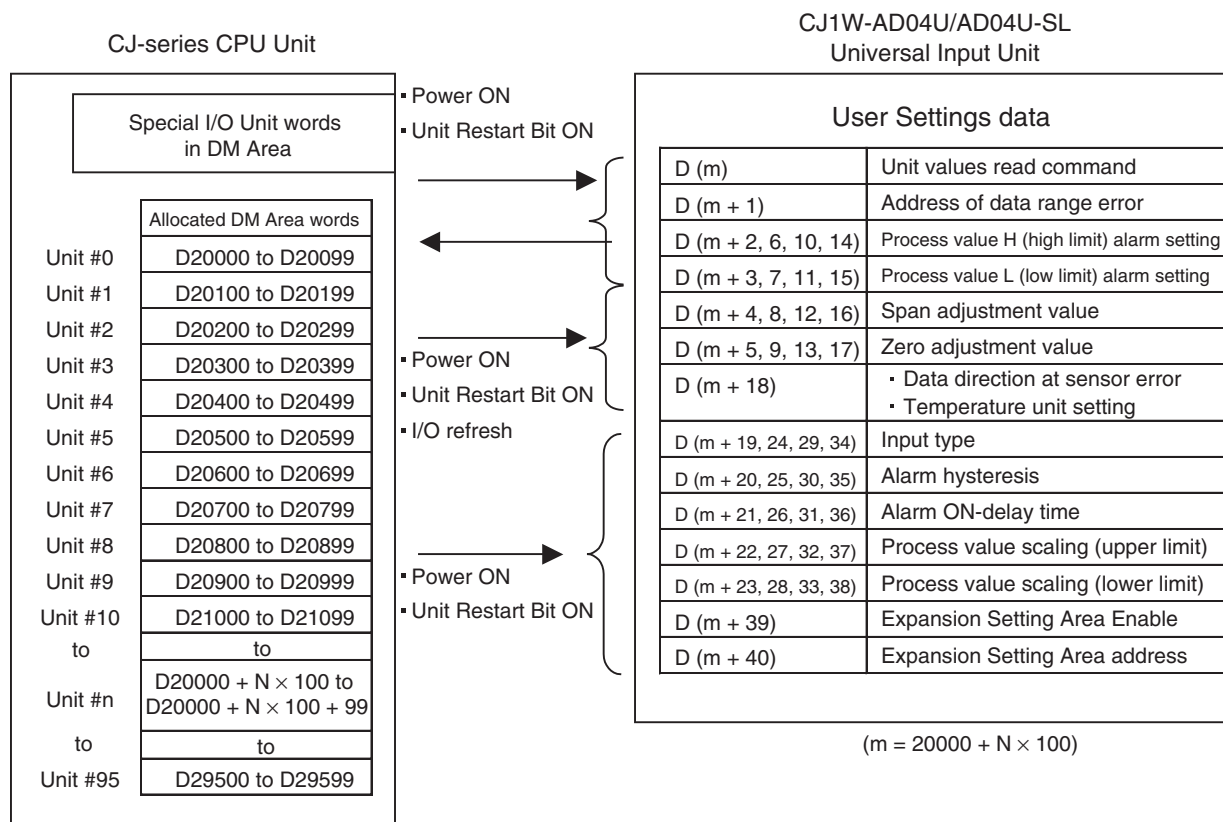

N: Unit No.

Note The unit number switch setting on the front panel of the Unit determines which words in the Special I/O Unit Area and DM Area words are allocated to each Universal Input Unit.

DM Allocation Contents

The following table shows the allocation of DM words and bits.

Refer to 4-2 Detailed Description of User Settings Area Data for details.

DM word (See note 1.)	Bit															
	15	14	13	12	11	10	09	08	07	06	05	04	03	02	01	00
m	Unit default values read command															
m + 1	Address of data range error															
m + 2	Input 1 Process value H (high limit) alarm setting															
m + 3	Input 1 Process value L (low limit) alarm setting															
m + 4	Input 1 Span adjustment value															
m + 5	Input 1 Zero adjustment value															
m + 6	Input 2 Process value H (high limit) alarm setting															
m + 7	Input 2 Process value L (low limit) alarm setting															
m + 8	Input 2 Span adjustment value															
m + 9	Input 2 Zero adjustment value															

DM word (See note 1.)	Bit															
	15	14	13	12	11	10	09	08	07	06	05	04	03	02	01	00
m + 10	Input 3 Process value H (high limit) alarm setting															
m + 11	Input 3 Process value L (low limit) alarm setting															
m + 12	Input 3 Span adjustment value															
m + 13	Input 3 Zero adjustment value															
m + 14	Input 4 Process value H (high limit) alarm setting															
m + 15	Input 4 Process value L (low limit) alarm setting															
m + 16	Input 4 Span adjustment value															
m + 17	Input 4 Zero adjustment value															
m + 18	High/low value after sensor error				Not used.								Temperature unit setting			
	Input 4	Input 3	Input 2	Input 1									Input 4	Input 3	Input 2	Input 1
m + 19	Input 1 Input type setting															
m + 20	Input 1 Alarm hysteresis															
m + 21	Input 1 Alarm ON delay time															
m + 22	Input 1 Process value scaling (upper limit)															
m + 23	Input 1 Process value scaling (lower limit)															
m + 24	Input 2 Input type setting															
m + 25	Input 2 Alarm hysteresis															
m + 26	Input 2 Alarm ON delay time															
m + 27	Input 2 Process value scaling (upper limit)															
m + 28	Input 2 Process value scaling (lower limit)															
m + 29	Input 3 Input type setting															
m + 30	Input 3 Alarm hysteresis															
m + 31	Input 3 Alarm ON delay time															
m + 32	Input 3 Process value scaling (upper limit)															
m + 33	Input 3 Process value scaling (lower limit)															
m + 34	Input 4 Input type setting															
m + 35	Input 4 Alarm hysteresis															
m + 36	Input 4 Alarm ON delay time															
m + 37	Input 4 Process value scaling (upper limit)															
m + 38	Input 4 Process value scaling (lower limit)															
m + 39	Expansion Setting Area Enable (See note 2.)															
m + 40	Expansion Setting Area address (See note 2.)															

- Note**
1. The first address of the Special I/O Unit words allocated to the Unit in the DM Area is:
 $m = 20000 + (\text{unit number} \times 100)$
 2. Refer to 4-3 *Expansion Setting Area* for details on the Expansion Setting Area.

Set Values and Stored Values

Setting	Set value or stored value	Default	Page
Unit values read command	12345 (3039 hex): Transfer initial values from the Input Unit to the CPU Unit. 0: Transfer allocated DM Area settings from the CPU Unit to the Input Unit.	0 (0000 hex)	P. 39
Address of data range error	0, or 2 to 40: Indicates address where error occurred. (See note 1.)	0 (0000 hex)	P. 39
Process value H (high limit) alarm setting	-32,768 to 32,767: Sets the PV's high limit alarm value.	32,767 (7FFF hex)	P. 37
Process value L (low limit) alarm setting	-32,768 to 32,767: Sets the PV's low limit alarm value.	-32,768 (8000 hex)	P. 37
Span adjustment value	0 to 32,000: Sets the span adjustment value ($\times 0.0001$).	10000 (2710 hex)	P. 34
Zero adjustment value	-9,999 to 9,999: Sets the zero adjustment value (LSB).	0 (0000 hex)	P. 34
High/low value after sensor error	0: Switch to high value after sensor error. 1: Switch to low value after sensor error.	0 (0000 hex)	P. 36
Temperature unit setting	0: °C 1: °F	0 (0000 hex)	P. 33
Input type	0 (0000 hex): Pt100 3 (0003 hex): JPt100 7 (0007 hex): Pt1000 21 (0015 hex): K 23 (0017 hex): J 25 (0019 hex): T 33 (0021 hex): L 36 (0024 hex): R 37 (0025 hex): S 38 (0026 hex): B 48 (0030 hex): 4 to 20 mA 49 (0031 hex): 0 to 20 mA 50 (0032 hex): 1 to 5 V 53 (0035 hex): 0 to 5 V 54 (0036 hex): 0 to 10 V	54 (0036 hex)	P. 33
Alarm hysteresis	0 to 9,999: Sets the alarm hysteresis (LSB).	0 (0000 hex)	P. 38
Alarm ON delay time	0 to 60: Sets the alarm ON delay in seconds.	0 (0000 hex)	P. 38
Process value scaling (upper limit)	-32,000 to 32,000: Sets the process value scaling (upper limit).	4000 (0FA0 hex)	P. 35
Process value scaling (lower limit)	-32,000 to 32,000: Sets the process value scaling (lower limit).	0 (0000 hex)	P. 35
Expansion Setting Area Enable	0: Disabled 1: Enabled	0 (0000 hex)	P. 39
Expansion Setting Area address	0 to 6,143: Sets the starting address of the Expansion Setting Area.	0 (0000 hex)	P. 39

Note The ERC indicator on the Unit's front panel will light if an out-of-range setting is detected. The address of the first word containing an invalid setting is stored in the "address of data range error" word in four digits hexadecimal, as the offset from word m, i.e., address m + offset.

Refer to *SECTION 5 Error Processing* for details.

Data Allocation in the Operating Data Area

The Unit's Operating Data data is transferred to the CPU Unit every cycle through the 10 words allocated to the Unit in the Special I/O Unit Area.

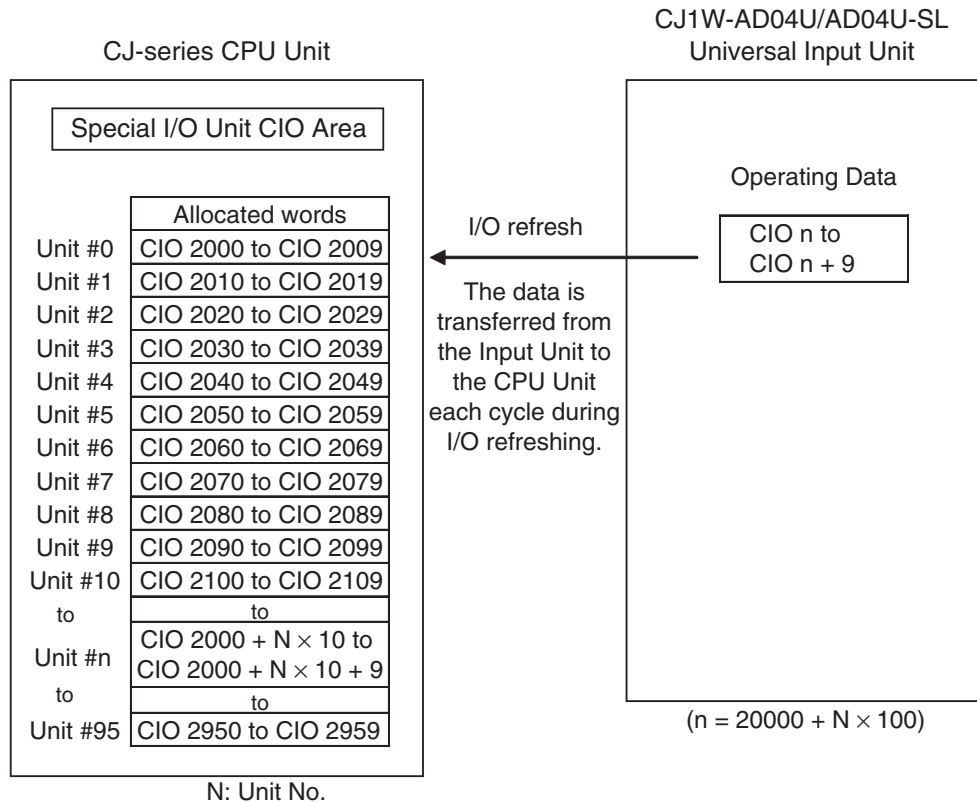

Contents of the Operating Data

For the CIO word addresses, n = CIO 2000 + (10 × unit number)

Word	Bit																			
									07	06	05	04	03	02	01	00				
n	Not used.								Process value alarm											
					Input 4				Input 3				Input 2				Input 1			
	H		L		H		L		H		L		H		L		H		L	
	(high limit)		(low limit)		(high limit)		(low limit)		(high limit)		(low limit)		(high limit)		(low limit)		(high limit)		(low limit)	
n + 1	Input 1 process value																			
n + 2	Input 2 process value																			
n + 3	Input 3 process value																			
n + 4	Input 4 process value																			
n + 5	Not used.																			
n + 6																				
n + 7																				
n + 8																				
n + 9	Conversion Data Enabled Flag	Not used.				Cold Junction Sensor Error				Not used.				Sensor Error						
						Input 4	Input 3	Input 2	Input 1					Input 4	Input 3	Input 2	Input 1			

Note Temperatures are represented in 0.1° increments.

Set Values and Stored Values

Contents	Set Values and Stored Values		Page
Process value alarm	H (high limit)	0: Process value < Set value 1: Process value ≥ Set value	P. 37
	L (low limit)	0: Process value > Set value 1: Process value ≤ Set value	
Process value	16-bit binary data		P. 32
Conversion Data Enabled Flag (See note 1.)	0: Data disabled 1: Data enabled		---
Cold Junction Sensor Error Flag	0: Normal 1: Error		P. 39
Sensor Error Flag (See note 2.)	0: Normal 1: Error		---

- Note**
1. The Conversion Data Enabled Flag is OFF after the PLC is turned ON or the Unit is restarted. The flag is turned ON when the AD conversion data becomes stable (approximately 2 to 4 s) and remains ON during operation.
 2. The sensor error detection function operates when the input type is set to thermocouple input, platinum resistance thermometer input, 1 to 5 V voltage input, or 4 to 20 mA current input.

Input types	Disconnection detection level
Thermocouple input or platinum resistance thermometer input	Less than the minimum value in the input range -20°C or -20°F, or greater than the maximum value in input range +20°C or +20°F
1 to 5 V	Less than 0.3 V
4 to 20 mA	Less than 1.2 mA
0 to 5 V, 0 to 10 V, or 0 to 20 mA	Disconnection not detected.

Reading Process Values

Analog input process values are stored for each input number, in CIO words n+1 to n+4.

Word	Function	Stored value
n + 1	Input 1 process value	16-bit binary data
n + 2	Input 2 process value	
n + 3	Input 3 process value	
n + 4	Input 4 process value	

For the CIO word addresses, n = CIO 2000 + (10 × unit number).

Use MOV(021) or XFER(070) to read process values in the user program.

Example 1: In this example, the process value is read from only one input. (The unit number is 0.)

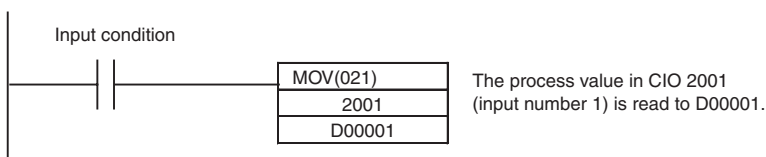

Note Temperatures are always read as 0.1 times the stored value.

Example 2: In this example, the process values are read from multiple inputs. (The unit number is 0.)

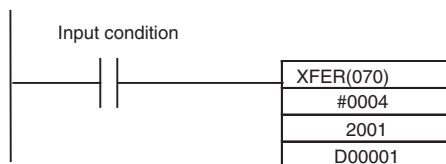

The process values in CIO 2001 to CIO 2004 (input numbers 1 to 4) are read to DM Area words D00001 to D00004.

4-2 Detailed Description of User Settings Area Data

4-2-1 Input Type Setting

The input type can be set independently for each input (inputs 1 to 4) to thermocouple input, platinum resistance thermometer input, current input (4 to 20 mA or 0 to 20 mA), or voltage input (1 to 5 V, 0 to 5 V, or 0 to 10 V).

After the input types are set in the corresponding DM words (m+19, m+24, m+29, and m+34), the input type settings will be transferred from the CPU Unit to the Universal Input Unit the next time that the power is turned ON or the Unit is restarted.

DM word	Function	Set values	
m + 19	Input 1 input type	0000 (0000 hex): Pt100	0048 (0030 hex): 4 to 20 mA
		0003 (0003 hex): JPt100	0049 (0031 hex): 0 to 20 mA
m + 24	Input 2 input type	0007 (0007 hex): Pt1000	0050 (0032 hex): 1 to 5 V
		0021 (0015 hex): K	0053 (0035 hex): 0 to 5 V
m + 29	Input 3 input type	0023 (0017 hex): J	0054 (0036 hex): 0 to 10 V
		0025 (0019 hex): T	
m + 34	Input 4 input type	0033 (0021 hex): L	
		0036 (0024 hex): R	
		0037 (0025 hex): S	
		0038 (0026 hex): B	

4-2-2 Temperature Unit Setting

When the input type is set to thermocouple input or platinum resistance thermometer input, set the temperature units to Celsius or Fahrenheit.

If the temperature is Celsius, it isn't necessary to set the temperature units because the default setting is 0: °C.

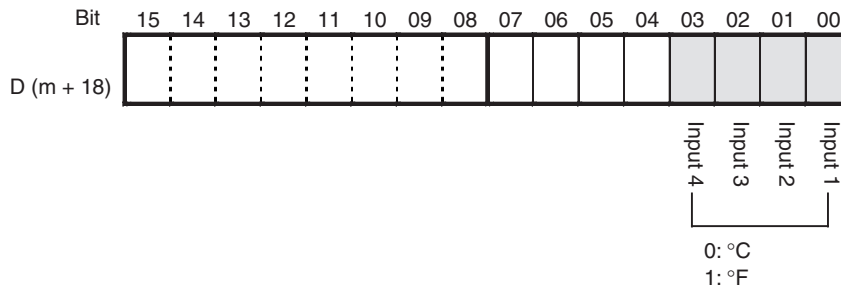

4-2-3 Zero/Span Adjustment

The zero point and span point can be adjusted for a process value.

The zero adjustment offsets the line plotting values before and after adjustment parallel to the original line. The span adjustment changes the slope of the line (i.e., the gain) around the minimum value in the range.

The zero adjustment value and the span adjustment gain are set in the DM Area words allocated in the CPU Unit. The settings are applied to the value after scaling.

These settings are refreshed during operation, so the values can be adjusted under normal operating conditions.

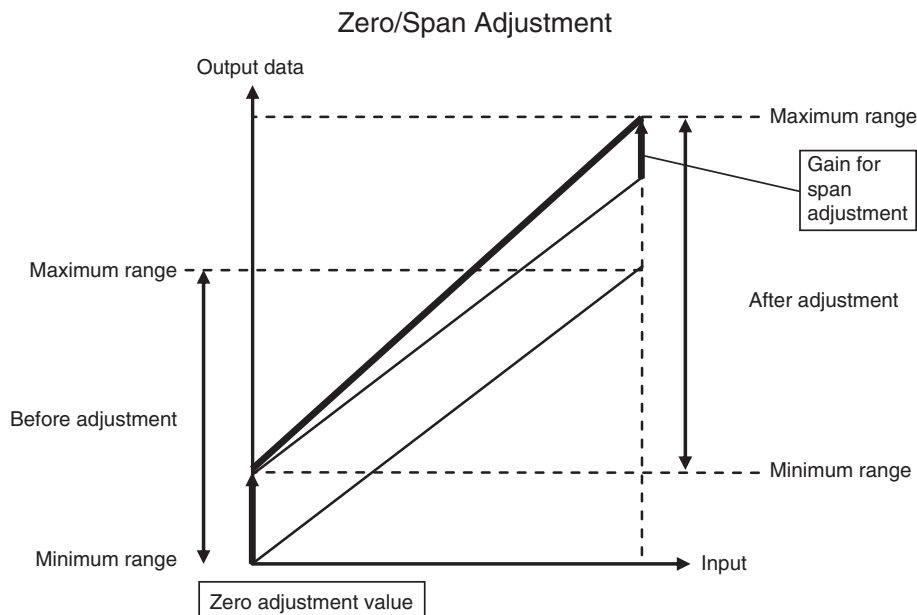

The Universal Input Units zero/span can be adjusted using a calibration device, as described below.

1,2,3...

1. Connect the Programming Device to the CPU Unit.
2. The following table shows the appropriate calibration device to connect for each input type.

Input type	Calibration device
Thermocouple input	Thermocouple calibrator
Platinum resistance thermometer input	Variable resistor
Voltage input	Voltage and current generator
Current input	Voltage and current generator

3. Turn ON the power to the PLC and calibration device, and wait for the required warm-up time.
4. Input a signal equivalent to 0% from the calibration device, and check the process value in the CPU Unit's CIO Area using the Programming Device.

If the value is abnormal, change the zero adjustment value in the DM Area, and adjust the offset (parallel movement) value.

DM word	Function	Set value
m + 5	Input 1 zero adjustment value	-9,999 to -1 (D8F1 to FFFF hex)
m + 9	Input 2 zero adjustment value	0 to 9,999 (0000 to 270F hex)
m + 13	Input 3 zero adjustment value	(set value × LSB)
m + 17	Input 4 zero adjustment value	

5. Input a signal equivalent to 100% from the calibration device, and check the process value in the CPU Unit's CIO Area using the Programming Device. If the value is abnormal, change the span adjustment gain value in the DM Area.

DM word	Function	Set value
m + 4	Input 1 span adjustment value	0 to 32,000 (0000 to 7D00 hex) (set value × 0.0001)
m + 8	Input 2 span adjustment value	
m + 12	Input 3 span adjustment value	
m + 16	Input 4 span adjustment value	

4-2-4 Scaling Function Settings

This function applies only to the voltage or current setting.

The input signal is scaled according to the input signal's lower limit and upper limit, and transferred to the CPU Unit as the process value. The lower limits and upper limits used to scale each input are set in DM Area words m+22 to m+38, as shown in the following table.

DM word	Function	Set value
m + 22	Input 1 scaling (upper limit)	-32,768 (8000 hex) to 32,767 (7FFF hex)
m + 23	Input 1 scaling (lower limit)	
m + 27	Input 2 scaling (upper limit)	
m + 28	Input 2 scaling (lower limit)	
m + 32	Input 3 scaling (upper limit)	
m + 33	Input 3 scaling (lower limit)	
m + 37	Input 4 scaling (upper limit)	
m + 38	Input 4 scaling (lower limit)	

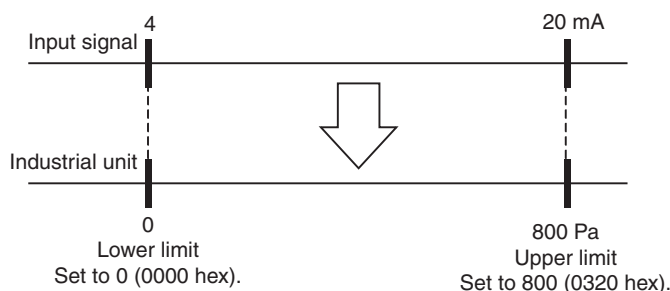

In the following example, an input 1 current input signal of 4 to 20 mA is scaled to industrial units of 0 to 800 Pa. The input 1 scaling upper limit in D20022 is set to 0320 hex (800 BCD) and the input 1 scaling lower limit in D20023 is set to 0000 hex (0 BCD).

Note This function is not applicable to temperatures.

4-2-5 Sensor Error (Disconnection) Detection and Operation

It is possible to detect a disconnected input circuit if the input type is set to thermocouple input, platinum resistance thermometer input, 1 to 5 V voltage input, or 4 to 20 mA current input.

Input type	Disconnection detection level
Thermocouple input or platinum resistance thermometer input	Less than the minimum value in the input range -20°C or -20°F , or greater than the maximum value in input range $+20^{\circ}\text{C}$ or $+20^{\circ}\text{F}$
1 to 5 V voltage input	Less than 0.3 V
4 to 20 mA current input	Less than 1.2 mA

- Note**
- The sensor error detection level varies with the zero and span adjustment values.
 - This function cannot be used when the input type is set to a 0 to 5 V voltage input, 0 to 10 V voltage input, or 0 to 20 mA current input. Bits 00 to 03 of n+9 contain the Sensor Error Flags.

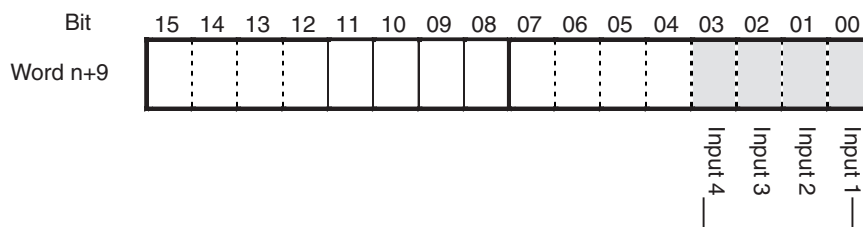

If a disconnection is detected in an input, the corresponding flag above is turned ON. The flag is turned OFF when the disconnection is corrected.

Example: In this case, the converted value is read only when analog input 1 is not disconnected. (The unit number is 0.)

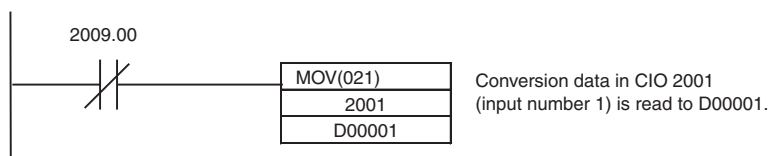

When a sensor error is detected, the process value can be fixed at the highest value or lowest value.

The allowable range limits are as follows:

- Temperature Input
 - Upper limit: Upper limit of temperature range $+20^{\circ}\text{C}$ or $+20^{\circ}\text{F}$
 - Lower limit: Lower limit of temperature range -20°C or -20°F
- Voltage/Current Input
 - Upper limit: 105%
 - Lower limit: -5%

The high/low value setting is set in DM word $m+18$, as shown in the following diagram.

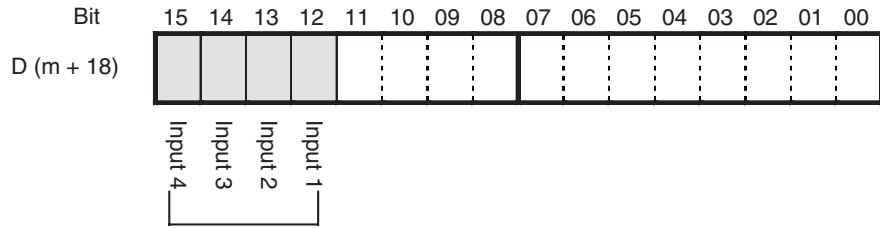

- 0: Fix the process value at highest value when there is a sensor error.
- 1: Fix the process value at lowest value when there is a sensor error.

4-2-6 Process Value Alarm Settings

High and low limit alarm values can be set independently for each input's process value. One high limit and one low limit can be set.

The Expansion Setting Area can be used to output a limit alarms to an output device without using the ladder program.

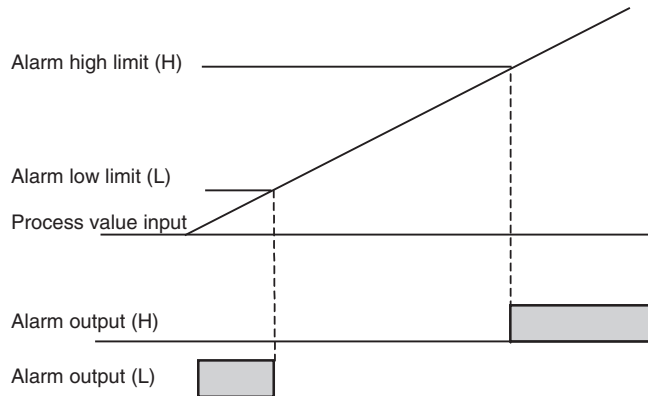

Each input's high and low alarm set values are set in the DM Area, as shown in the following table.

DM word	Function	Set value
$m + 2$	Input 1 H (high limit) alarm set value	-32,768 (8000 hex) to 32,767 (FFFF hex)
$m + 3$	Input 1 L (low limit) alarm set value	
$m + 6$	Input 2 (high limit) alarm set value	
$m + 7$	Input 2 (low limit) alarm set value	
$m + 10$	Input 3 (high limit) alarm set value	
$m + 11$	Input 3 (low limit) alarm set value	
$m + 14$	Input 4 (high limit) alarm set value	
$m + 15$	Input 4 (low limit) alarm set value	

Note The settings apply to the process value after zero and span adjustment.

4-2-7 Alarm Hysteresis Settings

Hysteresis values can be set for the process value alarm outputs. Frequent ON/OFF switching of the alarm output can be eliminated by setting a dead zone between the alarm output's start and stop.

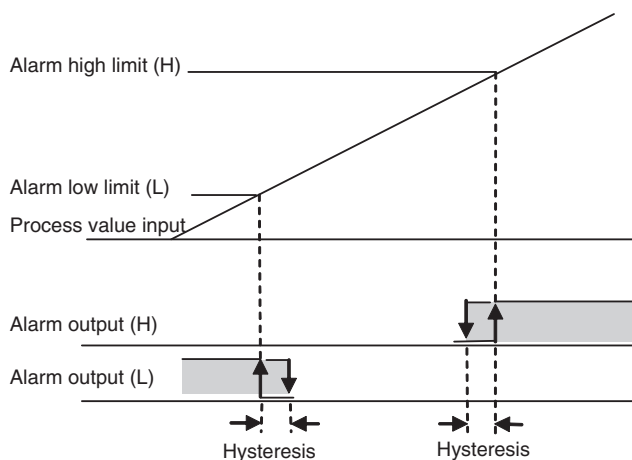

DM word	Function	Set value
m + 20	Input 1 alarm hysteresis set value	0 (0000 hex) to 9,999 (270F hex)
m + 25	Input 2 alarm hysteresis set value	
m + 30	Input 3 alarm hysteresis set value	
m + 35	Input 4 alarm hysteresis set value	

4-2-8 Alarm Output ON Delay Settings

A fixed time delay can be set before the output starts for an alarm output (high or low limit). The ON delay can be set between 1 and 60 s. Each channel's ON delay is set independently, but the same ON delay applies to the channel's high and low limit alarms. The alarm output will be turned OFF when the process value goes beyond the alarm output's range (including the hysteresis value).

The following example shows the operation of the high limit alarm output.

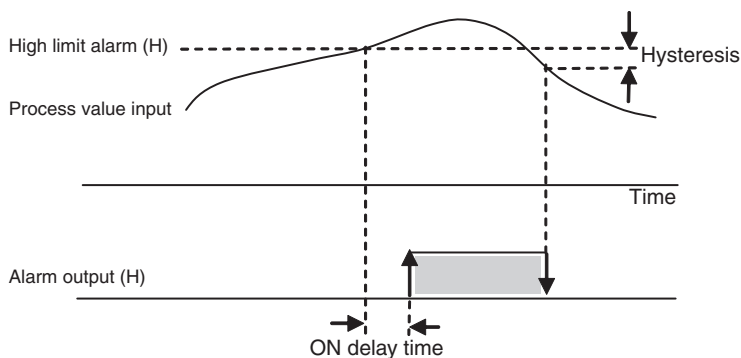

DM word	Function	Set value
m + 21	Input 1 alarm ON delay time	0 to 60 s (0000 to 003C hex)
m + 26	Input 2 alarm ON delay time	
m + 31	Input 3 alarm ON delay time	
m + 36	Input 4 alarm ON delay time	

4-2-9 Cold Junction Sensor Error Detection

If one of the Unit's built-in cold junction sensors fails, the error is output to the corresponding bit in CIO word n+9, as shown in the following table.

CIO word	Bit	Contents	
CIO n + 9	08	Input 1 cold junction sensor error	0: Normal 1: Error
	09	Input 2 cold junction sensor error	
	10	Input 3 cold junction sensor error	
	11	Input 4 cold junction sensor error	

4-2-10 Other Settings

Unit Values Read Command

The default values in the Universal Input Unit can be read to the CPU Unit when the power is turned ON or the Input Unit is restarted.

DM word	Function	Set value
m + 0	Unit values read command	<ul style="list-style-type: none"> 12345 (3039 hex): The Input Unit's initial values are read from the Input Unit to CPU Unit words m+2 to m+40. (When the transfer is completed, this word is reset to 0000 hex.) 0000 hex or other value besides 12345 (3039 hex): The data in the allocated words of DM Area is transferred from the CPU Unit to the Universal Input Unit

Address of Data Range Error

If an invalid setting is detected in the DM Area's "continuously refreshed area" or "initial settings area," the ERC indicator on the Unit's front panel will light. The address of the last word containing an invalid setting is stored in the "address of data range error" word in four digits hexadecimal, as the offset from word m, i.e., the address is m + offset.

Refer to 5-2 *Errors Detected by the Universal Input Unit* for details.

4-3 Expansion Setting Area

The Expansion Settings Area can be set to transfer an alarm output directly to an output device such as an Output Unit (without going through the ladder program) when the process value exceeds the high or low limit alarm value.

Enabling the Expansion Setting Area

When using the Expansion Setting Area, make the following settings in m+39 and m+40.

m + 39	Expansion Setting Area Enable	0 hex: Not used. 1 hex: Used.
m + 40	Expansion Setting Area address	0 to 6143 (0000 to 17FF hex)

- Note**
- When specifying the Expansion Setting Area, be sure that it does not overlap with other areas that are being used. If areas overlap, the words that are allocated may be overwritten, resulting in unexpected operation.
 - When specifying the first word in the Expansion Setting Area, be sure that the Expansion Setting Area does not exceed the end of the data area.

Set DM word m+39 to 1 (enabling the Expansion Setting Area) and set m+40 to the word address of an output device such as a CJ1W-OC201 Output Unit.

The high and low limit alarm outputs for inputs 1 to 4 are written to CIO n (in the CPU Unit) every cycle, and simultaneously written to the word specified in m+40. This way, the high and low limit alarm outputs can be transferred to an Output Unit or other device without going through the ladder program.

Contents of the Expansion Setting Area

CIO word	Bit	Contents	
0	00	Input 1 Low limit alarm output	0: Process value > Set value 1: Process value ≤ Set value
	01	Input 1 High limit alarm output	0: Process value < Set value 1: Process value ≥ Set value
	02	Input 2 Low limit alarm output	0: Process value > Set value 1: Process value ≤ Set value
	03	Input 2 High limit alarm output	0: Process value < Set value 1: Process value ≥ Set value
	04	Input 3 Low limit alarm output	0: Process value > Set value 1: Process value ≤ Set value
	05	Input 3 High limit alarm output	0: Process value < Set value 1: Process value ≥ Set value
	06	Input 4 Low limit alarm output	0: Process value > Set value 1: Process value ≤ Set value
	07	Input 4 High limit alarm output	0: Process value < Set value 1: Process value ≥ Set value
	08 to 15	Not used.	---

Note These bits contain the same data that is output to bits 00 to 07 of CIO n.

Comparison of Operation with Enabled/Disabled Expansion Setting Area

The following example shows the operation of the alarm outputs when the process value of input 1 exceeds the high limit alarm value.

- Conditions

Universal Input Unit unit number: 0

Special I/O Unit Area: CIO 2000 to CIO 2009

Special I/O Unit words in DM Area: D20000 to D20099

Output Unit allocation:

CIO 0004 is allocated to the 16 outputs of a CJ1W-OC221 Output Unit.
(This word is not set as the Expansion Setting Area.)

CIO 0005 is allocated to the 8 outputs of a CJ1W-OC201 Output Unit.
(This word is set as the Expansion Setting Area.)

DM words m+39 and m+40 enable the Expansion Setting Area and set it to CIO 0005.

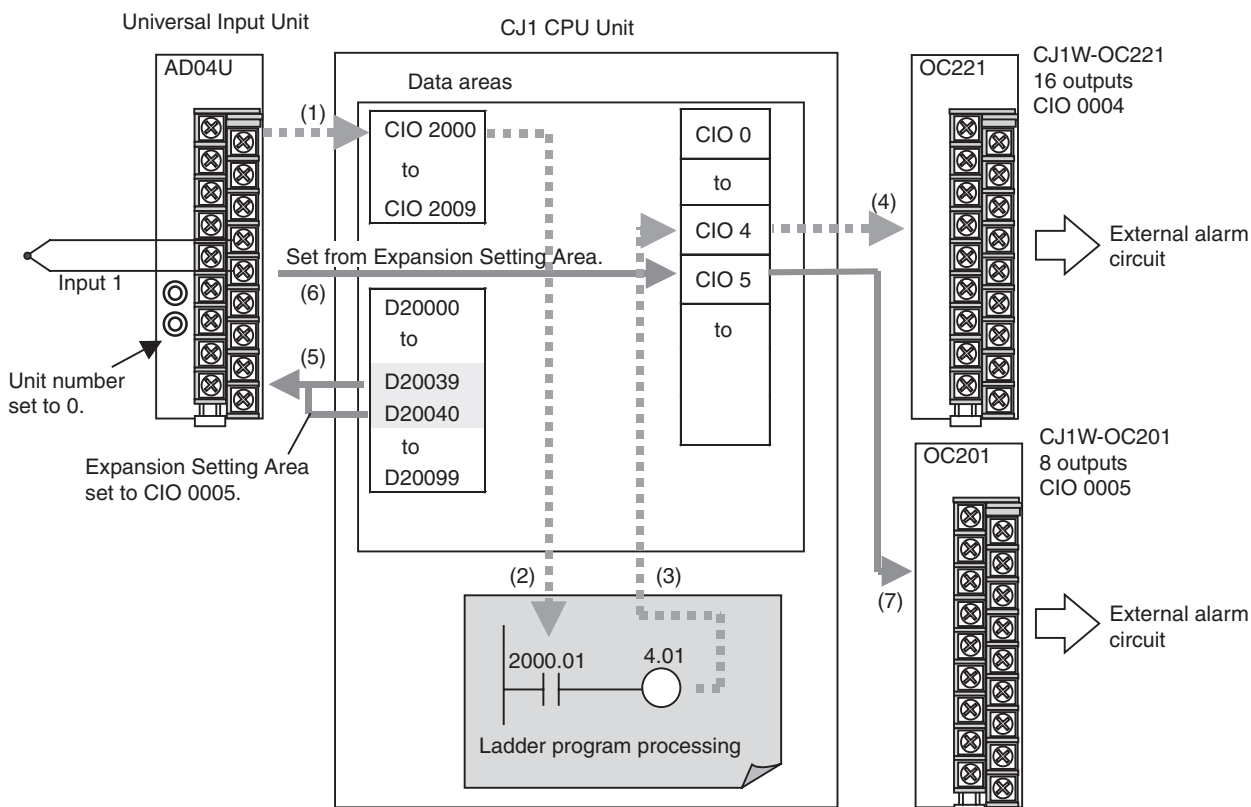

If the process value of input 1 exceeds the high limit alarm value, CPU Unit bit CIO 2000.01 is turned ON (1). If the CJ1 PLC's ladder program is being executed in RUN mode or MONITOR mode, the input condition of CIO 2000.01 (2) will be reflected in CIO 4.01 (3) and sent to Output Unit OC221 (4) where the alarm will be output.

If DM words D20039 and D20040 set CIO 0005 as the Expansion Setting Area (5), CIO 5.01 is turned ON directly from the AD04U Input Unit (6) and the alarm is output externally from Output Unit OC201 (7).

This is how the Expansion Setting Area settings can be used to set alarm outputs without using the ladder program.

SECTION 5

Error Processing

This section explains how to troubleshoot errors and alarms that occur in the CJ1W-AD04U and CJ1W-AD04U-SL Universal Input Units.

5-1	Indicators and Error Flowchart	44
5-2	Errors Detected by the Universal Input Unit.	44
5-3	Errors Related to the CPU Unit.	46
5-4	Restarting Special I/O Units	46
5-5	Troubleshooting	48

5-1 Indicators and Error Flowchart

Indicators

If an alarm or error occurs in the Universal Input Unit, the ERC or ERH indicators on the front panel of the Unit will light.

Front panel of Unit

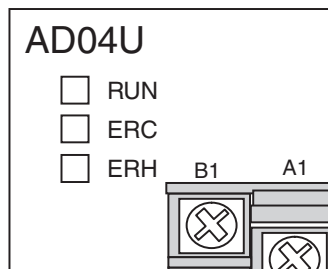

Indicator	Meaning	Indicator	Operating status
RUN (green)	Operating	Lit	Operating normally.
		Not lit	Unit has stopped exchanging data with the CPU Unit.
ERC (red)	Error detected by Unit	Lit	Alarm has occurred (such as disconnection detection) or initial settings are incorrect.
		Not lit	Operating normally.
ERH (red)	Error in the CPU Unit	Lit	Error has occurred during data exchange with the CPU Unit.
		Not lit	Operating normally.

5-2 Errors Detected by the Universal Input Unit

Indicator		Contents	Probable cause	Unit operation	Remedy
ERC (red)	RUN (green)				
Lit	Lit	Error in continuously refreshed area	An out-of-range setting was set in the continuously refreshed area (in the allocated DM Area words) after the Input Unit started operating normally.	The Unit will continue operating with the original continuously refreshed area data.	Restore the set value to within the allowable range. (There is no need to turn the power supply OFF and ON or to restart the Unit.)
		Sensor error	The input signal exceeded the upper or lower limit of the set input range by more than 20°C or 20°F.	Check the input sensor to see if it is operating correctly. Check the set input range to see if it is suitable.	The error will be cleared automatically when the input signal returns to within 20°C or 20°F of the set range.
	Not lit	Error in continuously refreshed area, initial settings area, or Expansion Setting Area settings	An out-of-range setting was set in the continuously refreshed area or initial settings area (in the allocated DM Area words).	The Unit will not start up.	Restore the set value to within the allowable range, and then either turn the power supply OFF and ON or restart the Unit.

Processing and Results in the Continuously Refreshed Area

Processing	Result	LED indicators on Unit	Data range error address stored in DM Area
While the power is ON, an out-of-range setting is set in the continuously refreshed area.	The Unit will continue operating with the original continuously refreshed area data.	ERC indicator is lit. RUN indicator remains lit.	The lowest DM address where the out-of-range error occurred is stored, in four digits hexadecimal, as the offset value from m (i.e., the number of added words).
↓			
Leave the power ON and change the setting to a valid value.	The Unit will operate with the edited settings in the continuously refreshed area.	ERC indicator is lit. RUN indicator remains lit.	If there is no other error, 0000 hex is stored. (If there is another error, the offset value for that DM address is stored.)
When the PLC is turned ON or the Unit is restarted with an error still in effect.	The Unit will not start up.	ERC indicator is lit. RUN indicator is not lit.	The lowest DM address where the out-of-range error occurred is stored, in four digits hexadecimal, as the offset value from m (i.e., the number of added words).
↓			
When the setting is made within the allowable range, and the PLC is turned ON or the Unit is restarted	The Unit starts up normally.	ERC indicator is not lit. RUN indicator is lit.	If there is no other error, 0000 hex is stored. (If there is another error, the offset value for that DM address is stored.)

Processing and Results in the Initial Settings Area

Processing	Result	LED indicators on Unit	Data range error address stored in DM Area
While the power is ON, an out-of-range setting is set in the initial settings area.	The Unit will continue operating with the original the initial settings area data.	ERC indicator is lit. RUN indicator remains lit.	If there is no error in the settings, the value remains 0000 hex. (If there is an error, the offset value for that DM address is stored.)
↓			
When the PLC is turned ON or when the Unit is restarted	The Unit will not start up.	ERC indicator is lit. RUN indicator is not lit.	The lowest DM address where the out-of-range error occurred is stored, in four digits hexadecimal, as the offset value from m (i.e., the number of added words).
↓			
When the setting is made within the allowable range, and the PLC is turned ON or the Unit is restarted	The Unit starts up normally.	ERC indicator is not lit. RUN indicator is lit.	If there is no other error, 0000 hex is stored. (If there is another error, the offset value for that DM address is stored.)

5-3 Errors Related to the CPU Unit

ERH LED (red)	RUN LED (green)	Contents	Probable cause	Error type	Detailed cause	Input Unit status	Remedy
Lit	Lit	Error in data exchange with the CPU Unit	During normal operation, an I/O bus error, CPU Unit monitoring error, or WDT error occurred at the CPU Unit.	I/O bus error	A data transmission error occurred between the CPU Unit and the Universal Input Unit.	Converted data becomes 0000 hex.	Turn OFF the power supply and check the installation conditions and the cable connections between devices. Then turn the power back ON.
				CPU Unit monitoring error	The CPU Unit did not respond within a fixed period of time.	Maintains the status existing before the error.	
				CPU Unit WDT error	WDT error has been generated at CPU Unit.	Changes to undefined state.	
	Not lit	Error in Multi-channel Analog Input Unit's unit number or mounting	Either the unit number is set incorrectly or the Unit is mounted incorrectly.	Duplicate Unit Number	The same unit number has been assigned to more than one Unit or the unit number was set to a value other than 00 to 95.	Conversion does not start.	Reset the unit number so that it will not duplicate any other.
Special I/O Unit Setting Error	A Universal Input Units registered in the I/O table is different from the ones actually mounted.			Check the mounting positions, and either mount the Units according to the I/O table or correct the I/O table.			
Fatal error at CPU Unit after turning ON the power supply						Take measures for CPU fatal error.	

5-4 Restarting Special I/O Units

To restore operation after the contents of the DM Area have been changed, or after the cause of an error has been cleared, either turn ON the power supply to the PLC or turn the Special I/O Unit Restart Bit ON and then OFF again.

- Special I/O Unit Restart Bit

Bits	Unit number	Bits	Unit number	Bits	Unit number
A502.00	Unit #0	A503.00	Unit #16	A504.00	Unit #32
A502.01	Unit #1	A503.01	Unit #17	A504.01	Unit #33
A502.02	Unit #2	A503.02	Unit #18	A504.02	Unit #34
A502.03	Unit #3	A503.03	Unit #19	A504.03	Unit #35
A502.04	Unit #4	A503.04	Unit #20	A504.04	Unit #36
A502.05	Unit #5	A503.05	Unit #21	A504.05	Unit #37
A502.06	Unit #6	A503.06	Unit #22	A504.06	Unit #38
A502.07	Unit #7	A503.07	Unit #23	A504.07	Unit #39
A502.08	Unit #8	A503.08	Unit #24	A504.08	Unit #40

Bits	Unit number	Bits	Unit number	Bits	Unit number
A502.09	Unit #9	A503.09	Unit #25	A504.09	Unit #41
A502.10	Unit #10	A503.10	Unit #26	A504.10	Unit #42
A502.11	Unit #11	A503.11	Unit #27	A504.11	Unit #43
A502.12	Unit #12	A503.12	Unit #28	A504.12	Unit #44
A502.13	Unit #13	A503.13	Unit #29	A504.13	Unit #45
A502.14	Unit #14	A503.14	Unit #30	A504.14	Unit #46
A502.15	Unit #15	A503.15	Unit #31	A504.15	Unit #47

Bits	Unit number	Bits	Unit number	Bits	Unit number
A505.00	Unit #48	A506.00	Unit #64	A507.00	Unit #80
A505.01	Unit #49	A506.01	Unit #65	A507.01	Unit #81
A505.02	Unit #50	A506.02	Unit #66	A507.02	Unit #82
A505.03	Unit #51	A506.03	Unit #67	A507.03	Unit #83
A505.04	Unit #52	A506.04	Unit #68	A507.04	Unit #84
A505.05	Unit #53	A506.05	Unit #69	A507.05	Unit #85
A505.06	Unit #54	A506.06	Unit #70	A507.06	Unit #86
A505.07	Unit #55	A506.07	Unit #71	A507.07	Unit #87
A505.08	Unit #56	A506.08	Unit #72	A507.08	Unit #88
A505.09	Unit #57	A506.09	Unit #73	A507.09	Unit #89
A505.10	Unit #58	A506.10	Unit #74	A507.10	Unit #90
A505.11	Unit #59	A506.11	Unit #75	A507.11	Unit #91
A505.12	Unit #60	A506.12	Unit #76	A507.12	Unit #92
A505.13	Unit #61	A506.13	Unit #77	A507.13	Unit #93
A505.14	Unit #62	A506.14	Unit #78	A507.14	Unit #94
A505.15	Unit #63	A506.15	Unit #79	A507.15	Unit #95

- The conversion data becomes 0000 during restart.

Note If the error is not cleared even after turning the Special I/O Unit Restart Bit ON and then OFF again, then replace the Unit.

5-5 Troubleshooting

The following tables explain the probable causes of troubles that may occur, and the countermeasures for dealing with them.

Conversion Data Does Not Change

Probable cause	Countermeasure	Page
The span adjustment value is set to 0.	Set the span adjustment value to a value other than 0.	P. 34
The input type setting is incorrect.	Check and correct the input type setting.	P. 33
An input device is faulty, input wiring is incorrectly wired, or wiring is disconnected.	Check whether the input value is changing. Check for faulty or disconnected wiring. Check whether a sensor error has been detected.	P. 19, P. 36
The minimum and maximum values for process value scaling are either the same or are set too close together.	Set the minimum and maximum process value scaling values correctly.	P. 35

Value Does Not Change as Intended

Probable cause	Countermeasure	Page
The zero/span adjustment values are incorrect.	Check and correct the zero/span adjustment settings.	P. 34
There is an error in the scaling settings.	Check and correct the scaling settings.	P. 35
A resistance thermometer's input wiring is incorrect.	Check and correct the input wiring.	P. 19
The compensating wire is too long and affecting operation.	Use a thicker thermocouple compensating wire.	---
The input type or process value scaling setting is incorrect.	Check the input type or process value scaling settings and correct if necessary.	P. 33, P. 35
Cold junction compensation is not operating.	Check the Cold Junction Sensor Error Flag.	P. 39
No compensating wire is being used, or another type of compensating wire is being used.	Use the correct thermocouple compensating wire.	---
The input wiring is faulty. (The polarity is incorrect in the thermocouple or compensating wire.)	Check and correct the input wiring.	P. 19

Conversion Values are Inconsistent

Probable cause	Countermeasure	Page
The input signals are being affected by external noise.	Change the connection paths of the input signal lines. (Separate them from sources of noise or use shielded twisted cable.) Insert a 0.01- μ F to 0.1- μ F ceramic capacitor or film capacitor between the input's (+) and (-) terminals.	---
The process value is being scaled beyond the Unit's resolution.	Reduce the process value's scaling value.	P. 35

Appendix A Dimensions

CJ1W-AD04U

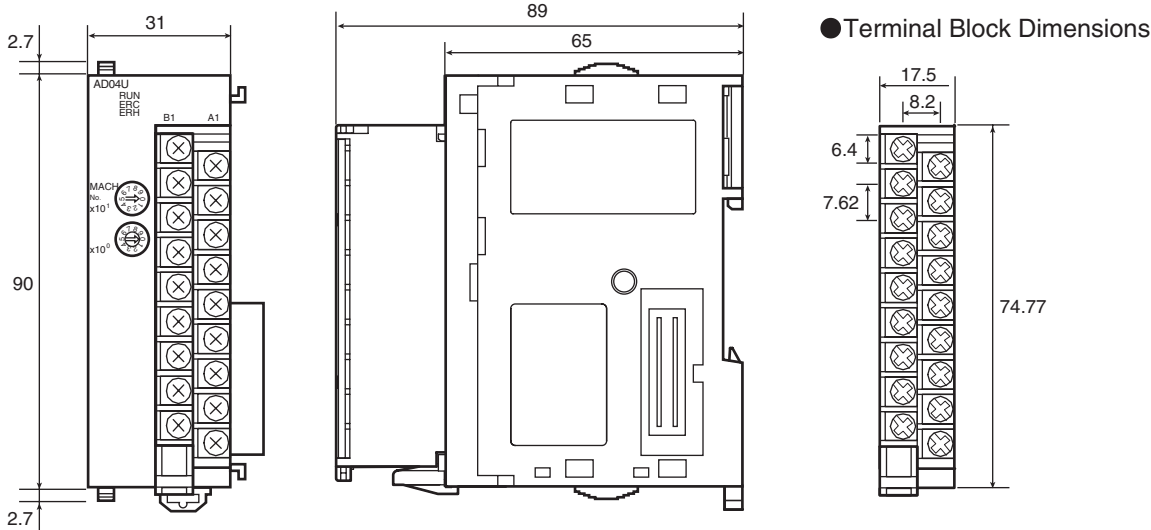

CJ1W- AD04U-SL

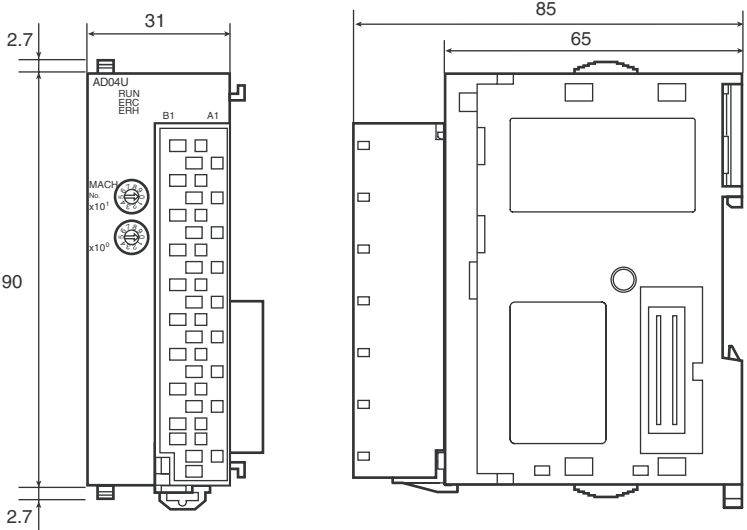

Appendix B

Supplementary Explanations of Functions

The following supplements the explanation given in *1-1 Features and Functions*.

Changing Set Values during Output of Process Value Alarm

H (High Limit) Alarms

When the alarm set value is raised while the alarm output is ON, the alarm output will be turned OFF when the following condition is satisfied.

$$\text{Input value} < (\text{alarm set value after change} - \text{hysteresis})$$

The alarm output will first turn OFF when the input value falls below the set value (with the hysteresis included).

L (Low Limit) Alarms

When the alarm set value is lowered while the alarm output is ON, the alarm output will be turned OFF when the following condition is satisfied.

$$\text{Input value} > (\text{alarm set value after change} + \text{hysteresis})$$

When the hysteresis part alone of the input value is greater than the set value, the alarm output will turn OFF for the first time.

Example: H Limit Alarms

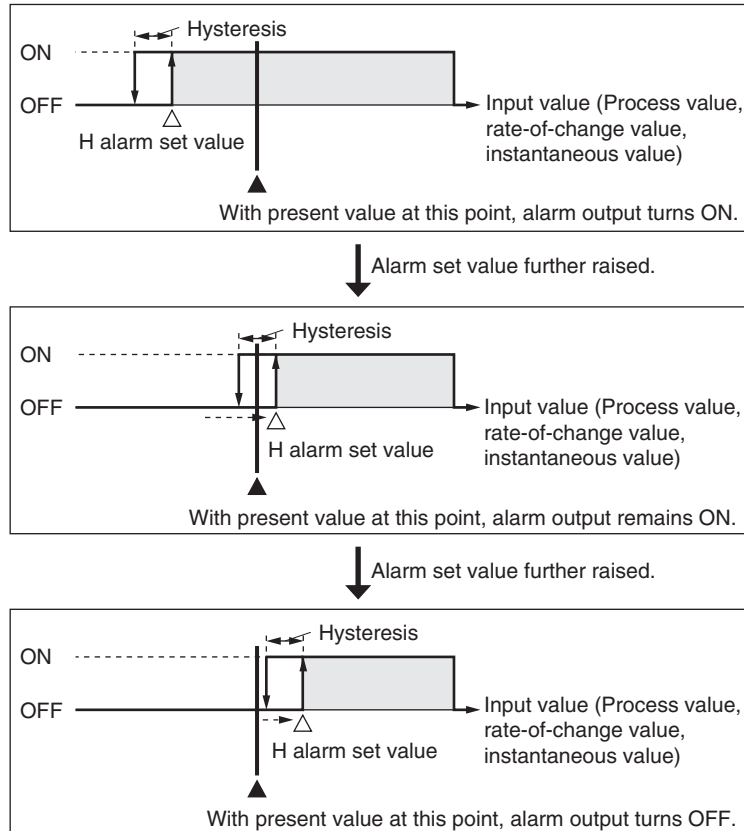

Alarm Operation when Upper Limit Is Less Than Lower Limit

When setting the process value's alarm set values, the high and low limit values can be set freely, regardless of which value is larger.

Example: $H < L$

The alarm output operation is determined solely by the relative sizes of the input value (scaling value) and alarm set values, as shown below.

H Limit Alarms

When the input value is greater than the alarm set value, the alarm output is turned ON.

L Limit Alarms

When the input value is less than the alarm set value, the alarm output is turned ON.

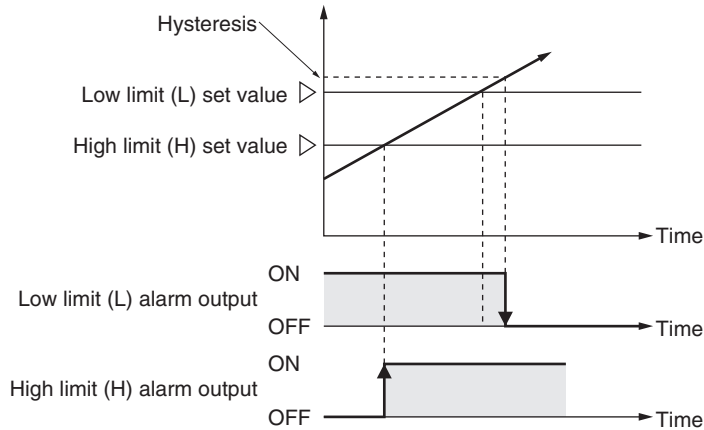

Alarm Output Operation when Falling Back from Alarm Condition Before Alarm-ON Delay Time Elapses

If inputs fall back from the alarm-ON condition (including hysteresis) before the alarm-ON delay time has elapsed, the alarm output will not turn ON.

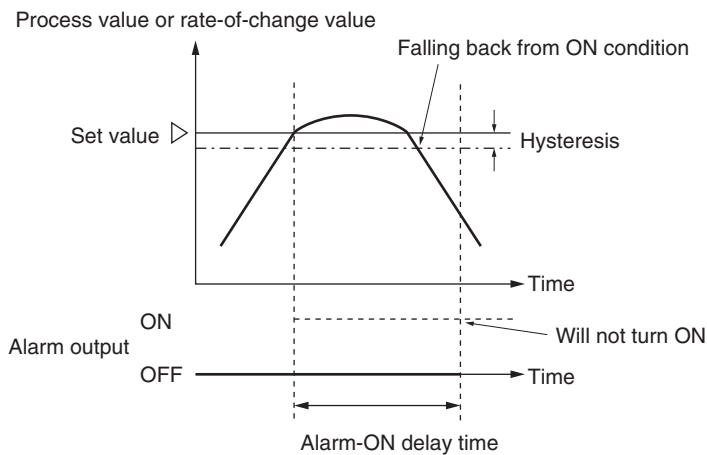

Setting Process Value Scaling with Negative Gain

With process value scaling in industrial units, a negative gain can be set by reversing the maximum and minimum values in the range.

The following values can be set for an input signal of 4 to 20 mA: Maximum process value in range = 0, minimum process value in range = 4000.

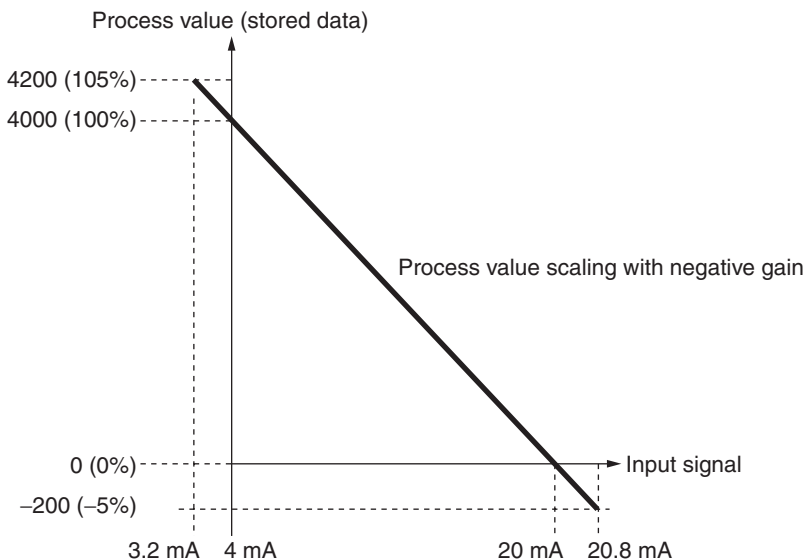

Alarm Operation during Process Value Scaling with Negative Gain

During process value scaling with negative gain, the alarm operates on the process value after scaling, and not on the input signal. Consequently, the operation is the same as for normal bias, as shown below.

H Limit Alarms

When the input value is greater than the alarm set value, the alarm output is turned ON.

L Limit Alarms

When the input value is less than the alarm set value, the alarm output is turned ON.

Example: If the maximum process value in the range is 0 and minimum process value in the range is 4,000 for an input signal of 4 to 20 mA, and if the H (high limit) alarm set value is 3,000, the alarm output will turn ON when the process value is greater than 3,000 (when the input signal is less than 8 mA).

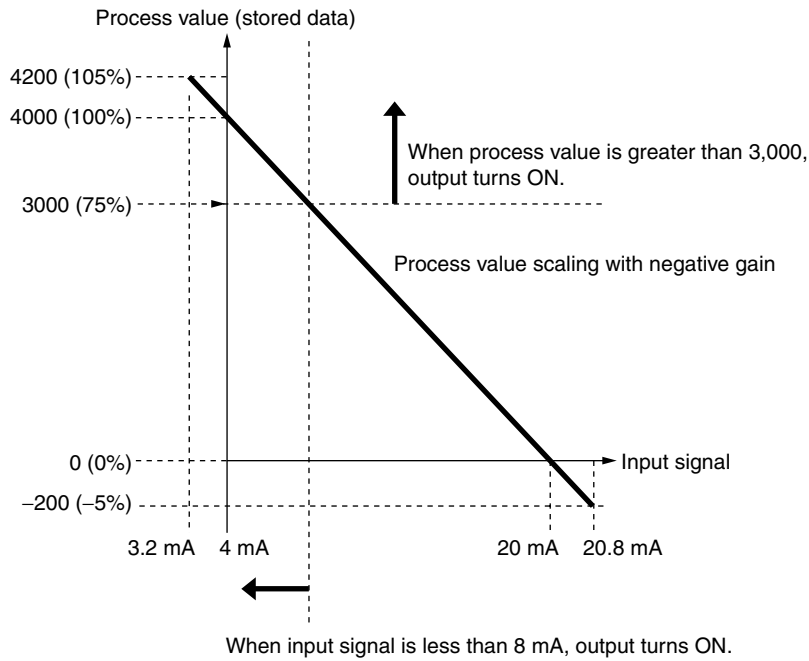

Switching to the High or Low Value when Input Disconnection Occurs during Process Value Scaling with Negative Gain

If an input becomes disconnected during process value scaling with negative gain, either the maximum (high) or minimum (low) process value can be set.

If the process value's *High/low value after sensor error* setting is set to high, the maximum process value will be set when the input is disconnected.

If the process value's *High/low value after sensor error* setting is set to low, the minimum process value will be set when the input is disconnected.

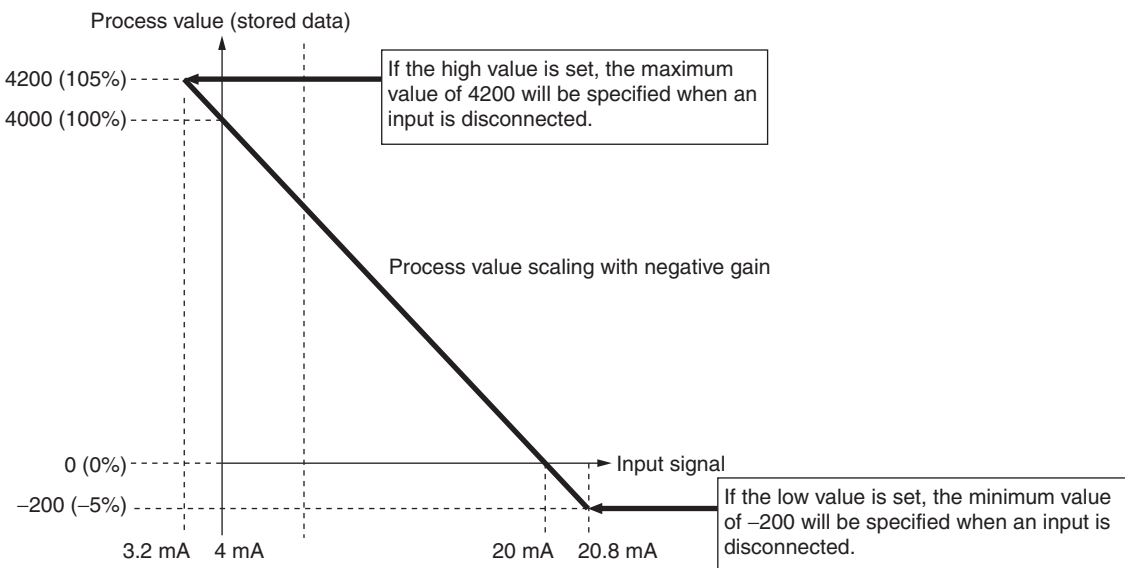

Appendix C

Data Coding Tables

□□: Unit number

DM word	Setting contents															
	15	14	13	12	11	10	09	08	07	06	05	04	03	02	01	00
D2□□00																
D2□□00																
D2□□01																
D2□□02																
D2□□03																
D2□□04																
D2□□05																
D2□□06																
D2□□07																
D2□□08																
D2□□09																
D2□□10																
D2□□11																
D2□□12																
D2□□13																
D2□□14																
D2□□15																
D2□□16																
D2□□17																
D2□□18					0			0								
D2□□19																
D2□□20																
D2□□21																
D2□□22																
D2□□23																
D2□□24																
D2□□25																
D2□□26																
D2□□27																
D2□□28																
D2□□29																
D2□□30																
D2□□31																
D2□□32																
D2□□33																
D2□□34																
D2□□35																
D2□□36																
D2□□37																
D2□□38																

DM word	Setting contents															
	15	14	13	12	11	10	09	08	07	06	05	04	03	02	01	00
D2□□39	0				0				0							
D2□□40																

Revision History

A manual revision code appears as a suffix to the catalog number on the front cover of the manual.

Cat. No. W466-E1-02



The following table outlines the changes made to the manual during each revision. Page numbers refer to the previous version.

	Date	Revised content
01	December 2006	Original production
02	December 2007	Changed product name to Universal Input Unit. Page xvii: Added warning. Page xix: Added two paragraphs at bottom of page. Page xx: Corrected voltage for Low Voltage Directive to 1,500. Page 2: Corrected top figure. Page 11: Removed "JIS, IEC" from input type specification. Page 15: Corrected model number and figure. Page 19: Corrected figure and added notes. Page 24: Corrected model number in first sentence. Page 38: Corrected descriptions of settings below top figure.

OMRON Corporation

Control Devices Division H.Q.

Shiokoji Horikawa, Shimogyo-ku,
Kyoto, 600-8530 Japan
Tel: (81)75-344-7109/Fax: (81)75-344-7149

Regional Headquarters

OMRON EUROPE B.V.

Wegalaan 67-69, NL-2132 JD Hoofddorp
The Netherlands
Tel: (31)2356-81-300/Fax: (31)2356-81-388

OMRON ELECTRONICS LLC

One Commerce Drive Schaumburg,
IL 60173-5302 U.S.A.
Tel: (1) 847-843-7900/Fax: (1) 847-843-7787

OMRON ASIA PACIFIC PTE. LTD.

No. 438A Alexandra Road # 05-05/08 (Lobby 2),
Alexandra Technopark, Singapore 119967
Tel: (65) 6835-3011/Fax: (65) 6835-2711

OMRON (CHINA) CO., LTD.

Room 2211, Bank of China Tower,
200 Yin Cheng Zhong Road,
Pu Dong New Area, Shanghai, 200120, China
Tel: (86) 21-5037-2222/Fax: (86) 21-5037-2200

OMRON

Authorized Distributor: