

The SOLUTIONS

[SSR Edition]

Relay Defects

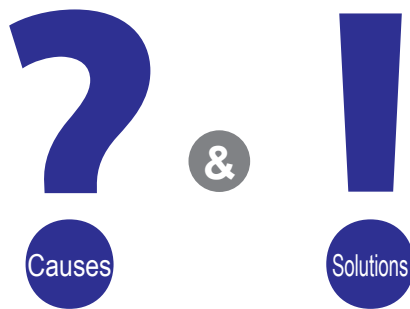

Correctly obtaining the performance of relays

Introduction

Thank you for your daily use of OMRON relays.

The beginning of the 1970s saw the start of the need for highly precise temperature control for devices such as molding machines (mold temperature) and electric furnaces as well as the need for automation and high-speed control in production equipment in order to improve productivity (to reduce takt time) at FA work sites. This led to the need for high-speed and high-frequency switching of relays, which increased the need for static relays (solid state relays, hereafter referred to as "SSRs").

OMRON outpaced its competitors in Japan to respond to these market needs, releasing the G3A Series (which is currently the G3NA Series) in 1974. In 1986, we released the first SSR with an integrated heat sink in the world, the G3PA. While responding to the need at automation work sites for relays that can perform high-speed and high-frequency switching and that also have long maintenance periods, we have developed a great variety of SSRs and have endeavored to improve the quality of our products through continuous reform.

We have just celebrated the 30th anniversary of the release of the first SSR with an integrated heat sink in the world, a product that made OMRON a pioneer in this field.

We would like to take this opportunity to thank all our customers for their continued patronage over all these years.

We have gathered in this document all the know-how related to correctly maximizing the performance of SSRs that we have accumulated through our experiences at automation work sites around the world.

It will make us very happy if this document, "The SOLUTIONS [SSR Edition]," helps you even slightly in understanding the causes of and solutions to the defects that occur at your work sites.

October 2016, OMRON Corporation

Precautions

- This document, "The SOLUTIONS [SSR Edition]," introduces common examples of defects that have been confirmed by OMRON customers. Note that the defects that you have confirmed may not correspond to any of the examples contained herein.
- Before requesting that OMRON analyze an SSR, we ask that you just check the outer appearance and the operation of the SSR, and then return the SSR to OMRON without disassembling it (such as by opening its case). Note that if you disassemble the relay (such as by opening its case) we may not be able to determine the true cause of the defect.

Table of Contents

SSR (Solid State Relay) Types and Application Examples	4
Examples of SSR Faults and Countermeasures	6
Flow Chart to Investigate Faults	8
CASE 01 Output Element Fault due to Inrush Current	10
CASE 02 Output Element Fault due to Load Short	12
CASE 03 Output Element Fault due to the Discharge Current during Single-phase Motor Forward/Reverse Operation	14
CASE 04 Output Element Fault due to Counter-electromotive Voltage	16
CASE 05 Output Element Fault due to Incorrect SSR Selection (90 VDC [200 VAC Half-wave Rectified Load])	18
CASE 06 Output Element Fault due to External Surge Voltage	20
CASE 07 Insulation Breakdown (Deterioration) due to the Effect of the Surrounding Environment	22
CASE 08 Release Failure due to Inductive Noise Applied to the Input Circuit	23
CASE 09 Half-wave Rectified Inductive Load Operation Failure	24
CASE 10 Heat Dissipation Failure due to Inadequate SSR Installation Conditions	26
CASE 11 Overheating due to Inadequate Control Panel Heat Dissipation	28
CASE 12 Burn Damage	30
CASE 13 Fault due to Three-phase Load Overcurrent	32
CASE 14 SSR Life Expectancy	34
CASE 15 SSR Selection Points	36
List of SSR Defect Causes (1) [Extended Load Operation (Intermittent Load Operation)]	38
List of SSR Defect Causes (2) [Failure of Load to Operate (Intermittent Shutting OFF of Loads)]	40
List of SSR Defect Causes (3) [Other Phenomena]	42
[Recommended Selections] SSRs with the Same Shapes as General-purpose Relays	44
[Recommended Selections] SSRs for Heater Control	46
[Recommended Selections] Temperature Controllers	48
[Recommended Selections] Input Equipments	50

SSR (Solid State Relay) Types and Application

Application examples

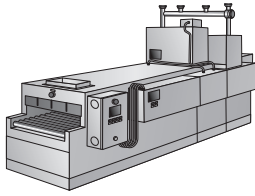

Furnaces (such as firing furnaces)

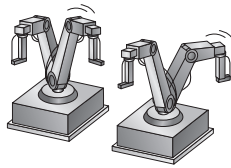

Robots

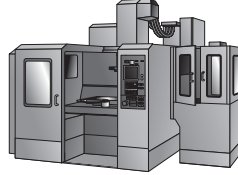

Machine tools

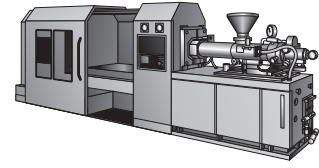

Molding machines

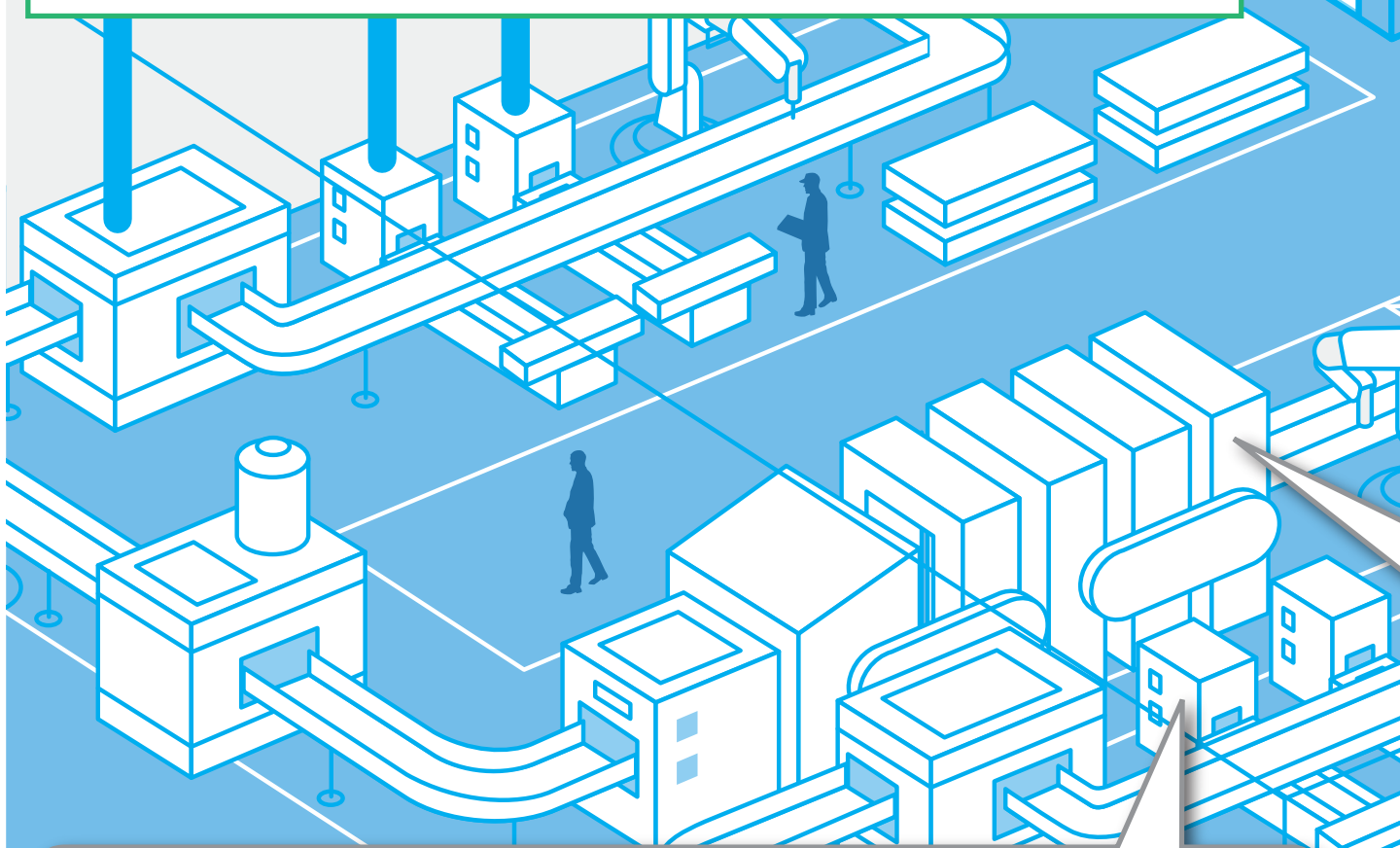

Solid State Relays with the Same Shapes as General-purpose Relays

- For the high-frequency driving of motors, heaters, electromagnetic valves, and magnets
- For isolation when handling sensor output signals

Programmable controller



Output

Input



G3F/G3FD (MY2)



G3H/G3HD (LY1, 2)



G3TA (G7T)



G3R (G2R-1-S)



G3RV-ST (G2RV-ST)

Output

Input

- Load
- Motor
 - Electromagnetic valve
 - Contactor
 - Heater etc.

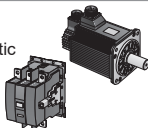

Sensor



* The models within parentheses are magnetic relays with the same shapes as general-purpose relays.

- ◆ Compared to mechanical relays, these relays are capable of high-speed response in the isolation application.

Typical models	Input specifications	Output specifications	Operating time	Release time
G3FD-X03SN-VD G3HD-X03SN-VD G3TA-ODX02S	DC		0.5 ms or less	2 ms or less
G3TA-IDZR02S			0.5 ms or less	2 ms or less

Typical models	Input specifications	Output specifications	Operating time	Release time
G3RV-ST700/500-A(L)	DC, AC	AC	11 ms or less	31 ms or less
G3RV-ST700/500-D(H)	DC, AC	DC	6 ms or less	21 ms or less

ion Examples

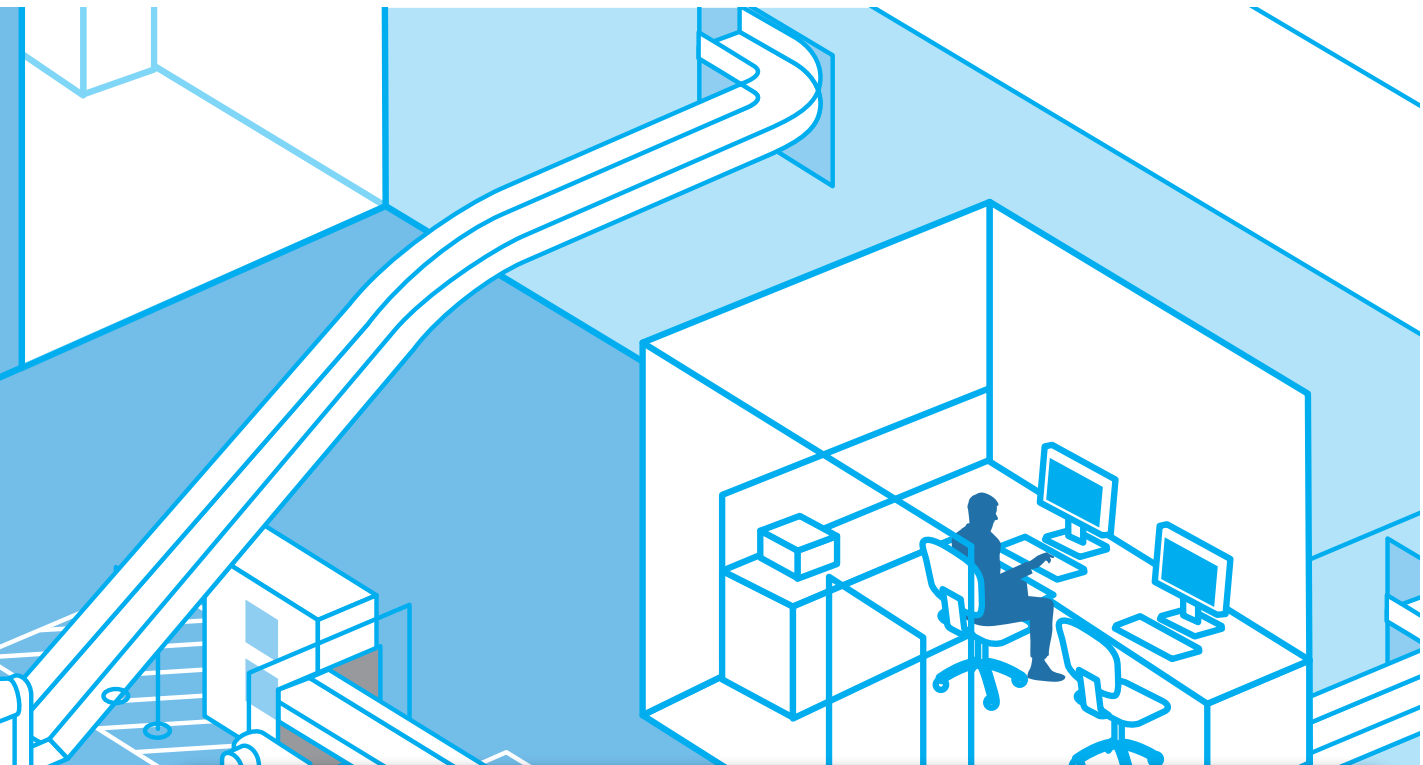

■ Solid State Relays

- Slim-profile SSRs with integrated heat sinks for installation in the compact spaces inside control panels
- SSRs with separate heat sinks for large-load switching while embedded within equipment

Mounting method	DIN track	G3PA	G3PJ For Heater Control	G3PE (three phase) For Heater Control
		Panel-mounting (with screws) <td>G3NA</td> <td>G3NE</td> <td>G3PH For Heater Control</td>	G3NA	G3NE

Cartridge replacement solid state relay	Compact, slim solid state relay	Three-phase, DIN track-compliant solid state contactor
Standard type for embedding in equipment	Faston terminal type	150 A switching, high-power solid state relay

Advanced Solid State Relays/Controllers for Heater Control

G3PF
With heater burnout detection function



G32A-EA
Cycle control unit (cycle control)



G3PW
Single-phase power controller (phase control and optimum cycle control)



G3ZA
Multi-channel power controller (optimum cycle control)



Examples of SSR Faults and Countermeasures

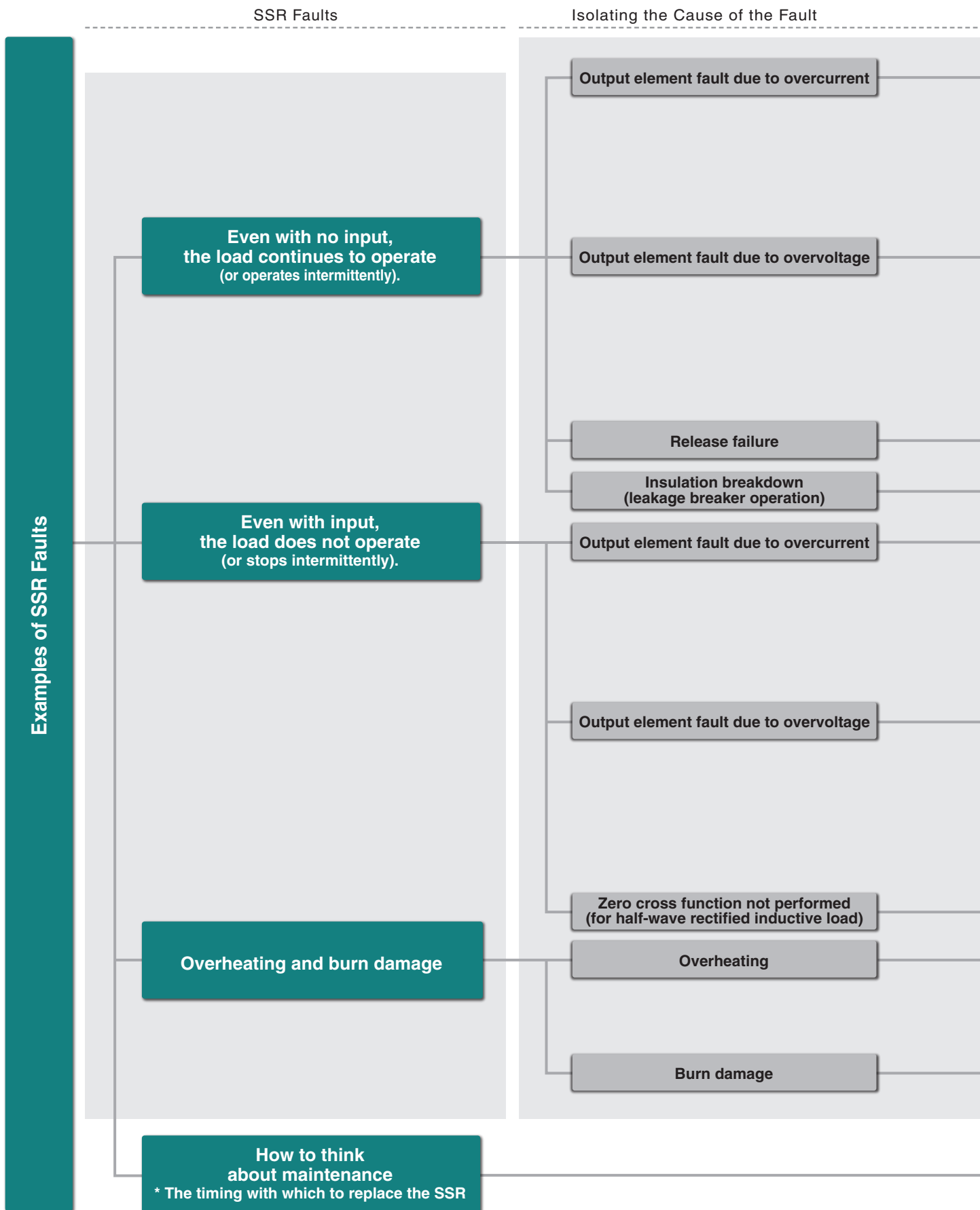

Precautions

- For information on fault examples not listed here, see lists (1) to (3) of SSR defect causes at the end of this document.
- Depending on the type of defect, SSR analysis may be necessary.

Examples of Faults and Countermeasures

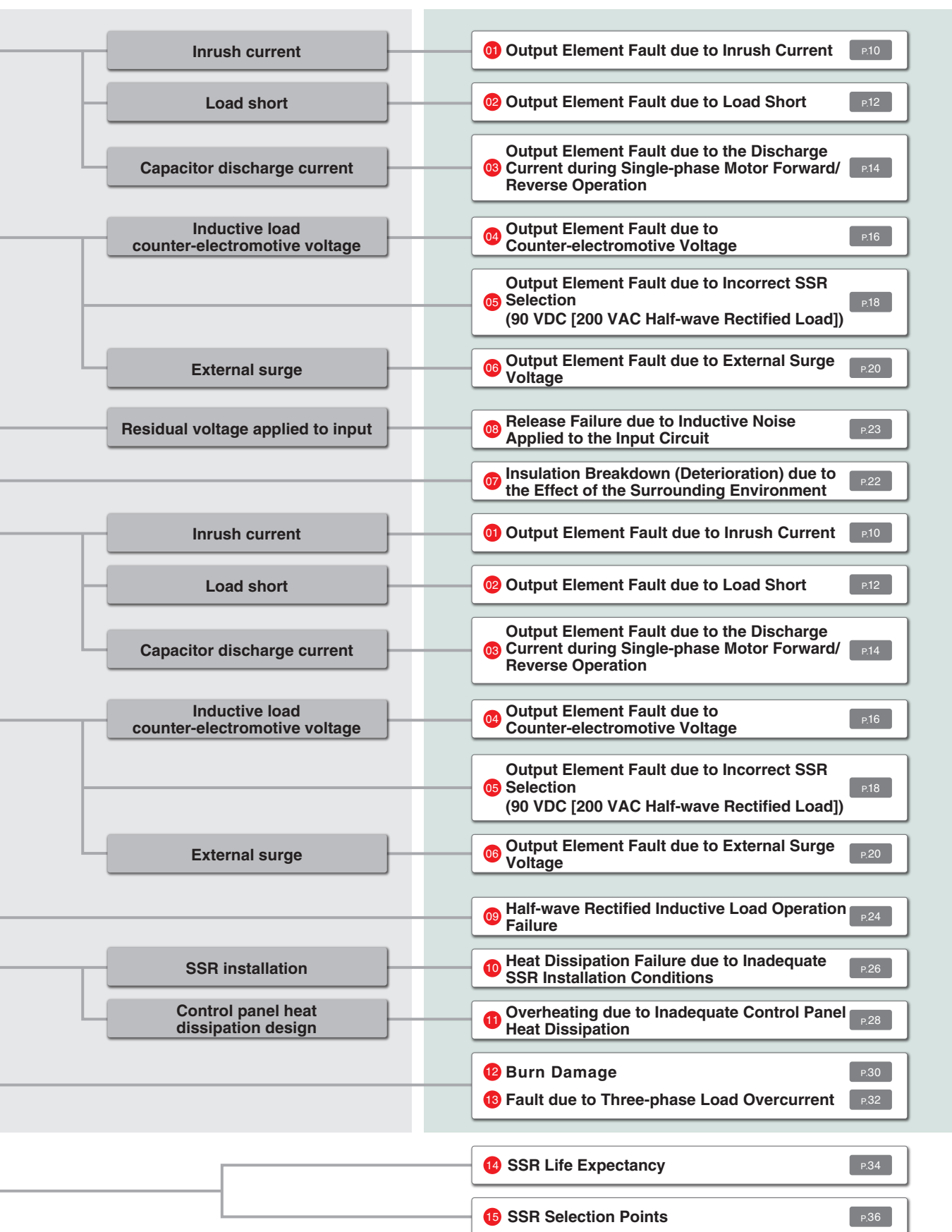

Flow Chart to Investigate Faults YES → NO →

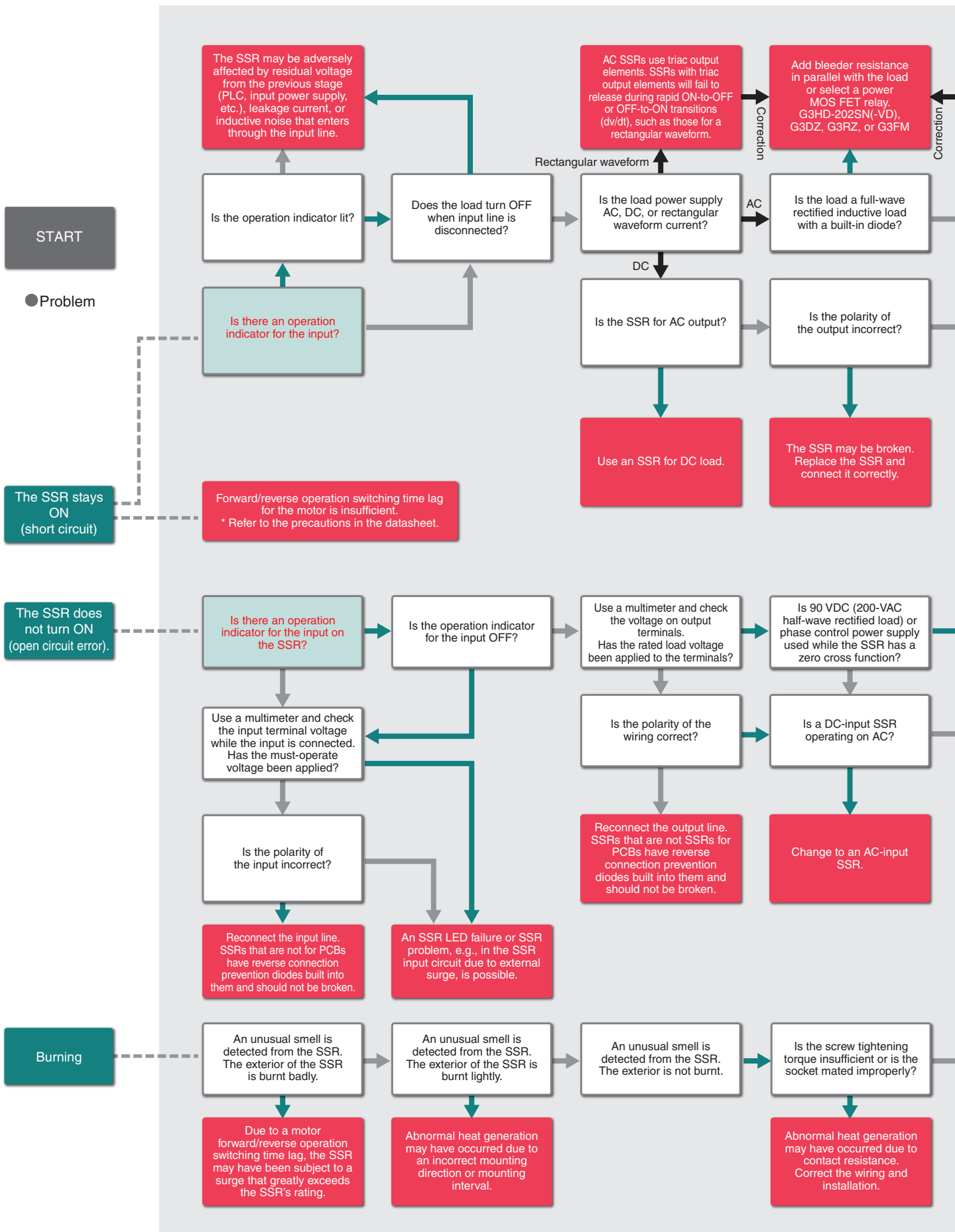

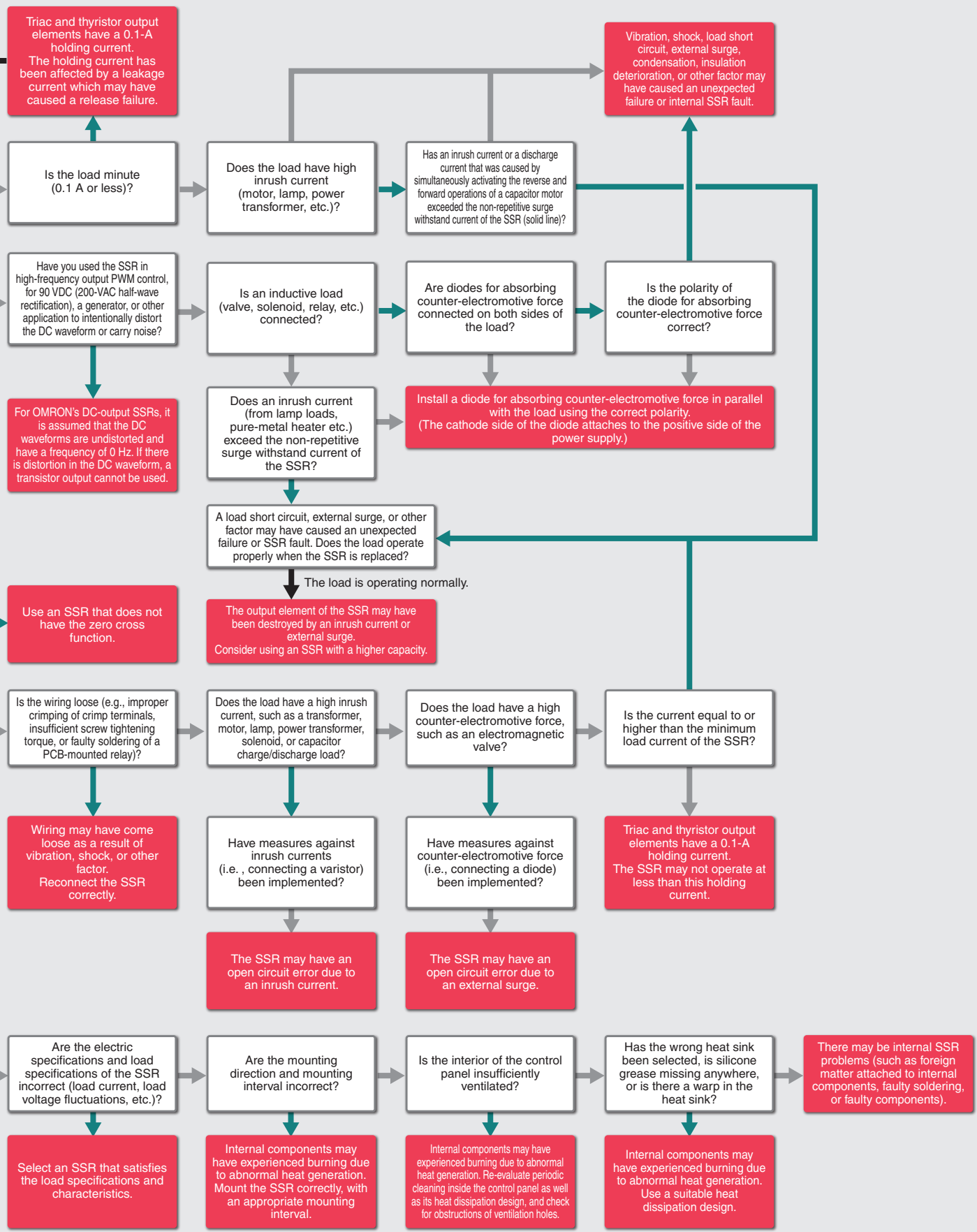

Output Element Fault due to Inrush Current

An inrush current that exceeds the withstand inrush current flowing through the SSR output element causes this fault.

- Output element short fault → The load operates (turns ON) even though the SSR's input is not applied.
- Output element open fault → The load does not operate even when the SSR's input is applied.

Likely Causes

Inrush current occurs when power is supplied to the load that is controlled by the SSR.

The inrush current values vary depending on the type of load, so the characteristics of different types of loads are shown below.

1. Heater load (resistive load)

Basically, inrush current does not occur with this type of load.

For special types of heaters, the resistance varies depending on the temperature. In this situation, caution is necessary at room temperatures, which cause the resistance to be low and thereby lead to inrush current occurring.

The inrush current exceeding the withstand inrush current of the SSR leads to an output element fault.

Types of heaters in which inrush current flows

- Pure-metal heaters (approximately 3 to 5 times the rated current)
- Ceramic heaters (approximately 3 to 5 times the rated current)
- Lamp heaters (approximately 10 to 15 times the rated current)

2. Lamp load

An inrush current that is approximately 10 to 15 times the rated current flows in incandescent light bulbs and halogen lamps (including lamp heaters and similar devices).

An inrush current that exceeds the withstand inrush current of the SSR flowing repeatedly causes an output element fault.

3. Motor load

When an inductive load such as a motor starts, an inrush current that is approximately 5 to 10 times the rated current flows.

An inrush current that exceeds the withstand inrush current of the SSR flowing repeatedly causes an output element fault.

4. Transformer load

With a transformer load, the instant that power is supplied to the primary side, an excitation current that is approximately 10 to 20 times the rated value flows, if only for a short time period of 10 to 500 ms.

An excitation current that exceeds the withstand inrush current of the SSR flowing repeatedly causes an output element fault.

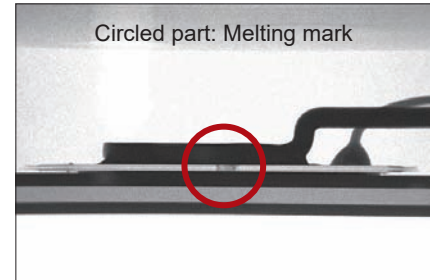

Photograph of an output element fault

Reference

Caution is required when power is supplied to the primary side without a load connected to the secondary side of the transformer (unloaded) as this results in the maximum excitation current.

1. Common Solution

When selecting an SSR, check the inrush current of the load, and then select a product that will provide an inrush current that is less than or equal to the (repeated) withstand inrush current of the SSR.

The table shown below provides estimated inrush currents for different types of loads, so before actually using the product, check the inrush current value by viewing the load catalog, contacting the load manufacturer, performing measurements with the actual equipment, or by similar means.

- SSR selection on the basis of the load

Example inrush current values for different types of loads are shown below.

AC load types and inrush current values

Load type	Solenoid	Incandescent light bulb	Motor	Relay	Capacitor	Resistive load
Inrush current/ steady-state current	Approx. 10 times	Approx. 10 to 15 times	Approx. 5 to 10 times	Approx. 2 to 3 times	Approx. 20 to 50 times	1
Waveform						

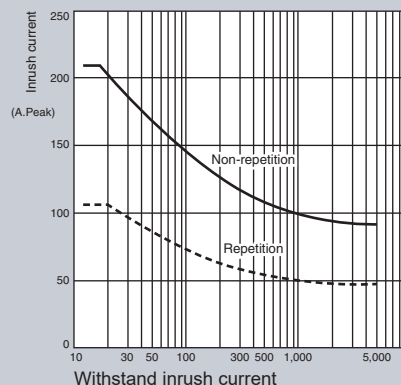

Reference

Difference between non-repetition and repetition in the withstand inrush current

• Non-repetition means that a surge current (A) exceeding the energized time (ms) even once will lead to a fault.

• Repetition means that a surge current being applied repeatedly in a single day (twice or more) may lead to a fault. Therefore, select an SSR that is at or below the repetition line (the dotted line in the graph).

Inrush current countermeasures for heater loads

When controlling heaters for which inrush current occurs (such as pure-metal heaters, ceramic heaters, and lamp heaters), use a power controller (a constant-current type or a long-period, soft start type).

OMRON power controller: G3PW Series

- Standard type
 - Long-period, soft start function
- Constant-current type
 - Constant-current function
 - Long-period, soft start function

Number of phases	Control terminal block	Type	Applicable output load	Heater burnout detection	Communication function	Model			
Single phase	Screwless clamp terminals	Standard type	20 A	100 to 240 VAC	No	No	G3PW-A220EU-C		
			45 A				G3PW-A245EU-C		
			60 A				G3PW-A260EU-C		
		Constant-current type	20 A				Yes	Yes	G3PW-A220EC-C-FLK
			45 A						G3PW-A245EC-C-FLK
			60 A						G3PW-A260EC-C-FLK
	Small slotted screw terminals	Standard type	20 A		No	No			G3PW-A220EU-S
			45 A						G3PW-A245EU-S
			60 A						G3PW-A260EU-S
		Constant-current type	20 A				Yes	Yes	G3PW-A220EC-S-FLK
			45 A						G3PW-A245EC-S-FLK
			60 A						G3PW-A260EC-S-FLK

Output Element Fault due to Load Short

If a short-circuit or an earth fault occurs in the wiring on the load side of the SSR (such as the load or the wiring), an excessive short-circuit current flows in the circuit on the load side. If this current exceeds the rating of the SSR and continues to flow, an output element fault will occur.

- Output element short fault → The load operates (turns ON) even though the SSR's input is not applied.
- Output element open fault → The load does not operate even when the SSR's input is applied.

Likely Causes

1. Load short

- Deterioration of load characteristics (deterioration of insulation)
- Deterioration of insulation, etc. due to factors such as condensation on the load wiring and terminals

2. Short-circuiting due to wiring deterioration and damage

- Deterioration of insulation due to cable damage caused by the movement of heaters and similar devices installed in the location that is driven
- Deterioration of insulation, etc. due to wiring cable damage caused by externally applied stress

3. Load short due to operation errors

- Wiring error etc. when replacing the heater or other load

Example 1

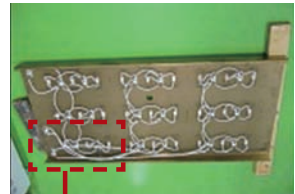

Whole heater panel



The area within the red circle is the location of the short-circuit.

Example 2



Supplemental

- Even when short-circuits and earth faults occur not continuously but instantaneously, the current value of the excessive short-circuit current that flows instantaneously exceeding the withstand surge current of the SSR will lead to an output element fault.
- Depending on the location where a short-circuit or earth fault occurs, the path along which the short-circuit current flows varies, which means that it can be expected that not only will an SSR fault occur, but that surrounding circuits will also be damaged. If you see marks indicating that short-circuit current has flowed, also check the surrounding circuits.

Solution

1. If you see marks indicating that earth faults or short-circuits have occurred, we recommend that you replace or check the SSR.
2. Install protective devices to counteract the short-circuit current that flows due to earth faults and short-circuits.

* If it is necessary to protect the SSR, we recommend that you use a quick-break fuse.

Quick-break fuse selection standard: SSR withstand inrush current > quick-break fuse fusing current > load inrush current

	Circuit protection (device and surrounding circuits)	SSR protection
Circuit breaker * Circuit protector, etc.	Yes	No
Fuse	Yes	No
Quick-break fuse	Yes	Yes

m e m o

A series of horizontal dashed lines for writing.

Output Element Fault due to the Discharge Current during Single-phase Motor Forward/Reverse Operation

The following precautions are present when using an SSR in the forward/reverse operation of a single-phase motor.

Implement countermeasures for the capacitor discharge current.

Precautions during Single-phase Motor Forward/Reverse Operation

1. Regarding the SSR load voltage

A phase-advancing capacitor has been added to the circuit for the forward/reverse operation of a single-phase motor.

In this circuit, a voltage that is approximately twice the maximum power supply voltage is applied to both ends of the SSR on the side that is OFF by way of the LC coupling between the motor's inductor L and phase-advancing capacitor C.

Therefore, it is necessary to use an SSR whose rated load voltage is at least twice the power supply voltage.

2. Time lag setting when switching between SSRs

(1) A triac is used in the output of an SSR. Even if the input is OFF, the output remains ON while the load current flows (for a half cycle of the maximum load power supply).

(2) When two SSRs turn ON at the same time, the electrical charge that the phase-advancing capacitor has been charged with is short-circuited with only these two SSRs, which causes a short-circuit current (discharge current) with a high di/dt to flow. This causes an SSR fault.

Therefore, use a program on the input device side to set a time lag of 30 ms or more when switching between the forward operation SSR and the reverse operation SSR.

3. SSR malfunction fail-safe

Even when you set a time lag as explained in section 2. above, if the SSR malfunctions due to causes such as external noise, the same short-circuit (closed circuit) explained in section 2. is constructed, which may cause an SSR fault to occur.

Therefore, connect a current limiting element in series with the capacitor.

Resistance and air core reactance current limiting elements types can be used.

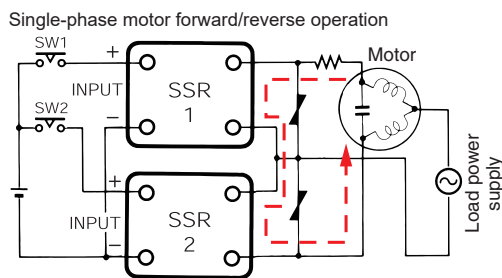

← Discharge current path

Recommended values for the SSR load current and protective resistance during single-phase motor forward/reverse operation

100 V single-phase motor	SSR load current (recommended)	Protective resistance during forward/reverse operation (recommended)
25 W	2 to 3 AAC	6 Ω
40 W		10 W
60 W	5 AAC	4 Ω
90 W		20 W
		3 Ω
		40 to 50 W

Solution

1. Select an SSR whose load voltage is greater than or equal to twice the power supply voltage.
2. Set a time lag using a program on the input device side.
3. Connect a resistance or reactance to limit the current.

m e m o

A series of horizontal dashed lines for writing.

Output Element Fault due to Counter-electromotive Voltage

If the counter-electromotive voltage generated when an inductive load (L load) turns OFF exceeds the withstand counter-electromotive voltage of the SSR, an output element fault will occur.

- Output element short fault → The load operates (turns ON) even though the SSR's input is not applied.
- Output element open fault → The load does not operate even when the SSR's input is applied.

Likely Causes

Inductive loads (L loads) have the characteristic of attempting to make a current flow even if the power supply is interrupted when the load is turned OFF. Therefore, a voltage with the reverse polarity of the power supply voltage applied to both ends of the load is generated. This voltage is called counter-electromotive voltage. If it exceeds the withstand counter-electromotive voltage* of the SSR, an SSR output element fault will occur.

* For the withstand counter-electromotive voltage of an SSR, see the following values.

- (1) AC-load-switching SSR
Item: Peak repetition OFF voltage
- (2) DC-load-switching SSR
Item: Voltage between collector and emitter

Example) Inductive loads that generate a counter-electromotive voltage
DC solenoids, electromagnetic valves, motor brakes, contactors, etc.

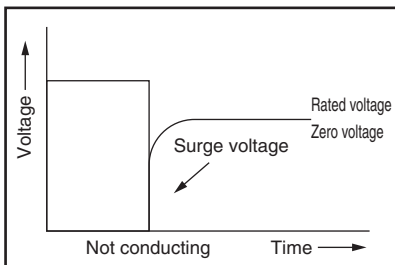

Solution

Connect a varistor or a diode to counteract the counter-electromotive voltage of an inductive load.

● AC circuit (AC load)

Consider connecting a varistor between the SSR output terminals or using a type of SSR with a built-in varistor.

For SSRs that do not have a built-in varistor, connect an external varistor as shown in the following figure.

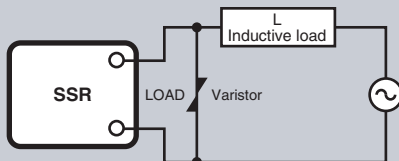

SSR output element (output circuit) protective varistor

Operating voltage	Varistor voltage	Surge withstand
100 to 120 VAC	240 to 270 V	1,000 A or more
200 to 240 VAC	440 to 470 V	
380 to 480 VAC	820 to 1000 V	

● DC circuit (DC load)

Connect the diode in parallel with the load.

A diode is most effective, but a long release time is required in order to eliminate the counter-electromotive voltage with the diode and load loop.

If the release time is a problem, you can shorten it by using the diode in combination with a Zener diode.

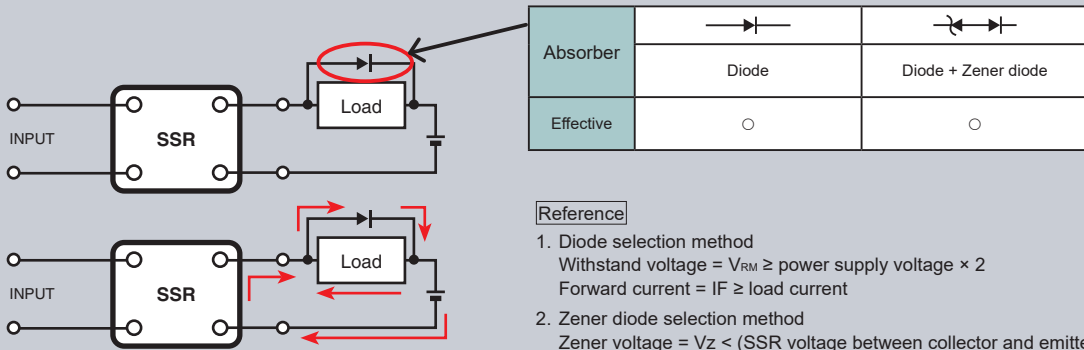

Reference

- Diode selection method
 Withstand voltage = $V_{RM} \geq \text{power supply voltage} \times 2$
 Forward current = $I_F \geq \text{load current}$
- Zener diode selection method
 Zener voltage = $V_Z < (\text{SSR voltage between collector and emitter}) - (\text{power supply voltage} + 2 \text{ V})$
 Zener surge power = $P_{RSM} > V_Z \times \text{load current} \times \text{safety factor (2 to 3)}$

Series name	G3NA	G3FD				G3HD		G3SD	G3TA				
Model	G3NA-D210B	G3FD-X03SN	G3FD-X03S	G3FD-102SN	G3FD-102S	G3HD-X03SN	G3HD-202SN	G3BD-103S	G3TA-IAZR02S	G3TA-IDZR02S	G3TA-IDZR02SM	G3TA-ODX02S	G3TA-OD201S
Voltage between collector and emitter (V_{ce0})	400 V	80 V		200 V		80 V	$V_{bss} 600 \text{ V}$	150 V	80 V		80 V	400 V	

Series name	G3FM	G3RD		G3CN		G3R			G3TB			
Model	G3FM-2R5SLN	G3RD-101PN	G3RD-X02PN	G3CN-DX02P(1)	G3CN-DX03P(1)	G3R-IAZR1SN	G3R-IDZR1SN	G3R-IDZR1SN-1	G3R-ODX02SN	G3R-OD201SN	G3TB-OD201P	G3TB-OD201PM
Voltage between collector and emitter (V_{ce0})	$V_{bss} 500 \text{ V}$	180 V	80 V	120 V	80 V	80 V			80 V	600 V	80 V	400 V

Series name	G3S/G3SD		G3DZ				G3RZ	G3RV		
Model	G3SD-Z01P	G3SD-Z01P-PD	G3DZ-2R6PL	G3DZ-1R5PL	G3DZ-1R5PLG	G3DZ-DZ02P	G3DZ-DZ02PG	G3RZ-201SLN	G3RV-SR500-D	G3RV-SR700-D
Voltage between collector and emitter (V_{ce0})	32 V		$V_{bss} 600 \text{ V}$	$V_{bss} 400 \text{ V}$		$V_{bss} 60 \text{ V}$		$V_{bss} 600 \text{ V}$	$V_{bss} 60 \text{ V}$	

* The values are all reference values.

Output Element Fault due to Incorrect SSR Selection (90 VDC [200 VAC Half-wave Rectified Load])

Selecting a 100 VDC type SSR that uses a power transistor as an element when 90 VDC is indicated for some AC electromagnetic counters (coils), solenoids, and motor brakes will lead to an SSR fault or burn damage due to overvoltage.

- Output element short fault → The load operates (turns ON) even though the SSR's input is not applied.
- Output element open fault → The load does not operate even when the SSR's input is applied.

Likely Causes

When a load's power supply specifications indicate 90 VDC, this generally means that the load has a built-in diode and half-wave rectifies 200 VAC.

Therefore, 284 VAC (the maximum value of 200 V [$200 \times \sqrt{2}$]) is applied between the output terminals of the SSR.

As such, selecting a 100 VDC SSR that uses a power transistor as an element will lead to overvoltage, which can cause an SSR fault or burn damage.

AC waveform

(1) 200 VAC (peak voltage: 284 V)

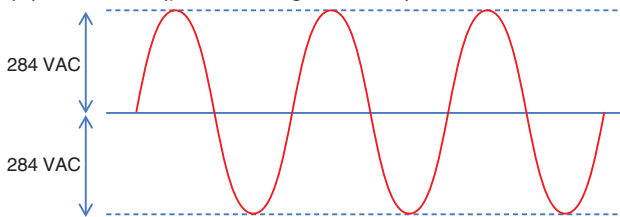

Half-wave rectified waveform

(2) 90 VDC (peak voltage: 284 V)

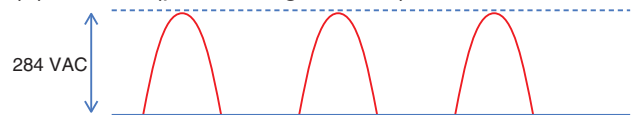

Solution

When controlling a load with 90 VDC (half-wave rectified 200 VAC) specifications, select the G3HD-202SN-VD, G3RZ-201SLN, or G3FM-2R5SLN depending on the load current.

* High-voltage-resistant MOSFETs are used for the output elements, so a half-wave rectified circuit voltage of 284 VAC (peak voltage) is also supported.

m e m o

A series of horizontal dashed lines for writing.

Output Element Fault due to External Surge Voltage

Sometimes, an inductive lightning surge can be superimposed on the power line in the load power supply, which may cause an SSR output element fault to occur. (A short fault occurs in the majority of cases.)

- Output element short fault → The load operates (turns ON) even though the SSR's input is not applied.

Likely Causes

If the external surge superimposed on the load power supply exceeds the absorption capacity of the SSR's built-in varistor, a voltage that exceeds the ratings is applied to the output elements, which causes an output element fault to occur.

External surge superimposed on the load power supply line

- Switching surge of another load (an inductive load) connected to the load power supply (on the same line)
- Inductive lightning surge transmitted to the power line

Surge voltage measurement example

Period: 2007/11/19 to 2007/12/26

Date	Time	Voltage (V)
2007/11/21	4:50:24	7444
2007/11/27	15:00:57	5452
2007/11/27	17:19:13	-5262
2007/11/30	14:09:46	-5155
2007/12/01	15:45:38	-5379
2007/12/02	21:03:26	-5200
2007/12/05	6:57:23	6525
2007/12/07	3:08:25	-5941
2007/12/07	4:59:02	-5200
2007/12/11	15:57:43	-5682

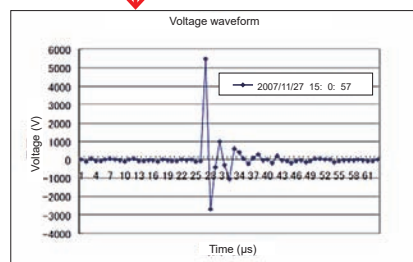
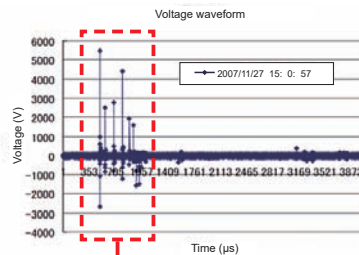

1. External varistor

Connect a varistor with a large absorption capacity to the power-incoming unit of the load power supply.

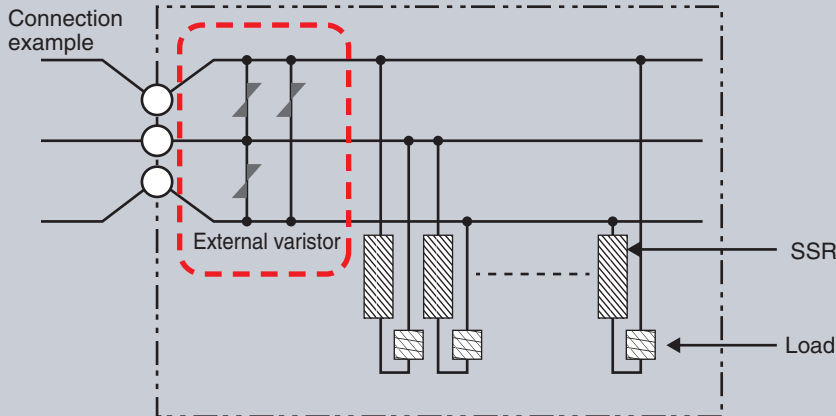

Selection standard for the external varistor to connect to the power-incoming unit of the load power supply

Operating voltage	Varistor voltage	Surge withstand
100 to 120 VAC	240 to 270 V	25,000 A
200 to 240 VAC	440 to 470 V	
380 to 480 VAC	820 to 1000 V	

* Generally, we recommend varistors that have a large surge withstand value and that are used for the surge protection of electrical and electronic devices in industrial settings.
When selecting a varistor, check the catalogs of varistor manufacturers.

2. Selecting an SSR that is resistant to external surges

When the load is a heater, it is possible to avoid faults due to external surges by using an OMRON SSR specially designed for use with heaters. These SSRs have an advanced withstand surge voltage thanks to our proprietary surge pass function. (These SSRs are designed only for use with heaters.)

Supplemental

- If a surge voltage that is too large to be avoided with the surge pass function is being superimposed, additionally consider the countermeasure explained in section 1.
- Products equipped with the surge pass function are SSRs specially designed for use with heaters. They cannot be used with inductive loads for which a problem occurs when they are turned ON for a half cycle such as lamps, motors, and valves.

SSRs with surge pass function

G3PE Series

G3PH Series

Reference value: Surge dielectric strength of 30 kV min.
1.2 × 50 μs standard voltage waveform,
peak voltage of 30 kV, repeated 50 times according to JIS C5442

Insulation Breakdown (Deterioration) due to the Effect of the Surrounding Environment

The effect of the surrounding environment (such as dust, water drops, condensation, and high humidity) may lead to the breakdown (deterioration) of the insulation between the SSR output terminals, which may lead to the load operating continuously (a short fault). Depending on the severity of the insulation breakdown (deterioration), burn damage may also occur.

Likely Causes

The dust from the surrounding environment accumulates on the load terminals of the SSR (including the internal terminals).

Mechanism of insulation breakdown (deterioration)

Dust accumulates between the load terminals of the SSR.



The dust absorbs the moisture from the atmosphere, which causes the insulation to deteriorate.



Leakage current flows, which causes joule heating to occur, leading to the formation of an electrical circuit (tracks) on the surface of the insulation due to carbonization. This causes the insulation deterioration to progress.

Causes of accelerated deterioration

- Amount of dust
- Adherence of condensation and water droplets
- Highly humid environment

In the worst case

Burn damage may even occur due to the expansion of the carbonization area and the increase in the amount of heat produced when the leakage current flows continuously in the same location.

Example 1



(The same position on a good product)

Solution

1. When designing the device in which the SSR is installed or the control panel, give thought to a structure that makes it difficult for dust and water droplets to enter.
 - * Use the SSR in an environment that has the rated usage temperature and humidity.
2. If it is not possible to prevent the intrusion of dust, plan for maintenance such as cleaning (such as of the parts that fit together, the terminals, and the heat sink fin), insulation resistance measurement, and replacement during periodic inspections.

Release Failure due to Inductive Noise Applied to the Input Circuit

If an induced voltage greater than or equal to the operating voltage or the release voltage is applied between the input terminals of the SSR, the SSR turns ON without any input being applied, so the load malfunctions.

Likely Causes

Do not install the input line and the power line in the same duct. Even if there is no input signal due, inductive noise may cause the SSR output to malfunction. If the input line (the red line in the diagram on the right) and the power line (the blue line in the diagram on the right) are wired in parallel, current flowing through the power line induces a voltage in the other conducting wire, which causes noise. If the value of this induced noise is greater than or equal to the operating voltage of the SSR, the SSR may turn on.

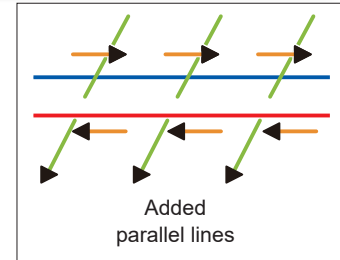

Solution

When voltage is induced on the SSR's input terminals due to inductive noise, it is necessary to use twisted wiring (electromagnetic induction) or shielded wires (electrostatic induction) to reduce the induced voltage on the SSR's input terminals—caused by inductive noise—to a value that is less than or equal to the release voltage of the SSR.

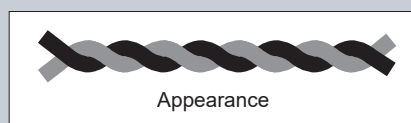
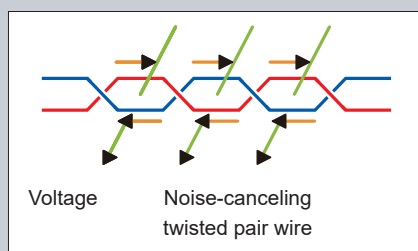

Half-wave Rectified Inductive Load Operation Failure

Operation failure (the SSR not being able to turn ON and the load not operating) may occur when using an SSR equipped with a zero cross function to switch a half-wave rectifying inductive load among AC electromagnetic counters (coils), solenoid valves, and motor brakes.

- Once the SSR turns ON, it is not possible to turn it OFF, so the load continues to operate.

Likely Causes

As shown in the following figure, SSRs designed for use with AC loads are equipped with a zero cross function that turns ON (operates) the SSR with the load voltage close to zero volts in order to reduce the noise that occurs due to the sudden load current when the load starts.

These SSRs are also equipped with an internal snubber circuit (R + C) to absorb noise, so for half-wave rectified inductive loads, C (the capacitor) is charged during the ON half wave and the electrical charge is discharged during the OFF half wave, which means that the voltage may not lower to close to zero volts (less than or equal to the zero cross voltage).

Therefore, although the zero cross function reduces the occurrence of noise and inrush current for AC loads, for half-wave rectified inductive loads this function makes it impossible to turn the SSR ON or OFF.

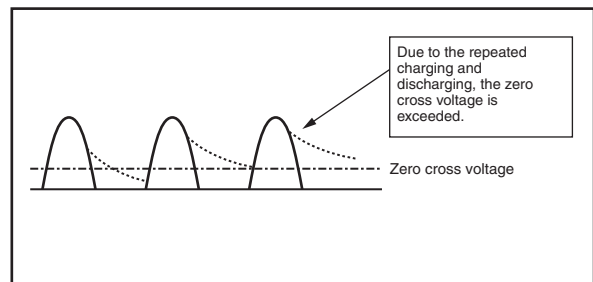
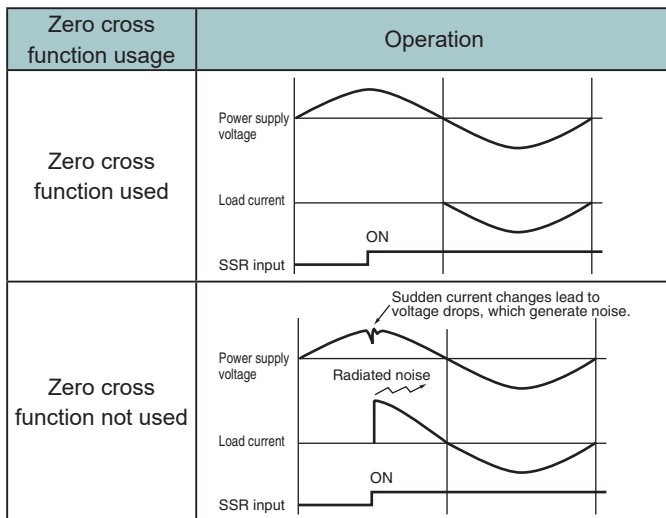

Solution

Select an SSR that does not have a zero cross function.

* For half-wave rectified loads, there are no SSRs that can be used with voltages that exceed 90 VDC.

Introducing SSRs that are commonly used with half-wave rectified inductive loads (with the same shapes as general-purpose relays [plug-in type SSRs])

90 VDC	G3HD-202SN-VD*
Other than 90 VDC	G3H-203SLN(-VD)*
* Select the SSR to match the load voltage.	G3F-203SLN(-VD)*
* These are plug-in SSRs.	G3FM-2R5SLN
	G3RZ-201SLN

* Caution
These loads use a power supply that half-wave rectifies the AC power supply. This is not a normal DC power supply, so exercise caution when using a DC SSR. See "CASE 05 Output Element Fault due to Incorrect SSR Selection."
*-VD means safety standard approved type (UL, CSA, EN)

Heat Dissipation Failure due to Inadequate SSR Installation Conditions

SSRs are relays that use semiconductors and generate heat.

Therefore, heat must be dissipated under the prescribed conditions.

If the installation or heat dissipation conditions are incorrect, SSR malfunction or fault may occur due to heat dissipation failure.

Likely Causes

1. Heat sink selection

For SSRs to which separate heat sinks can be attached (such as the G3NA and G3NE), select from the specified heat sinks. When using a commercially available heat sink, select one with a thermal resistance ($^{\circ}\text{C}/\text{W}$) less than or equal to the specified value.

2. Installation orientation

Basically, SSRs use natural convection to dissipate heat, so the heat dissipation efficiency varies depending on the installation orientation. Therefore, install the SSR with the specified orientation. Make sure that the load current is 50% of the rated load current when the SSR is mounted horizontally on a panel surface.

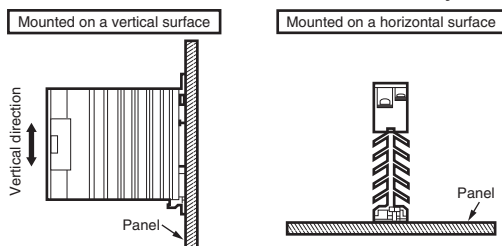

Note: Make sure that the load current is 50% of the rated load current when the SSR is mounted horizontally. For details on close mounting, refer to the related information under performance characteristics. Mount the SSR in a direction so that the markings read naturally.

3. Close mounting

It is possible to perform close mounting with some models, but this lowers the rated load current.

Also, note that the number of units that can be close mounted together is limited.

* For details, see the separate catalogs.

4. Load current vs. ambient temperature rating

The rated load current is the maximum rated current at a temperature of 40°C (or 25°C) or lower.

For ambient temperatures greater than this, the rated load current decreases.

* For details, see the separate catalogs.

Also, if a heat source is present near the installation location, distance the heat source from the installation location.

[Examples of incorrect installation conditions]

Example 1

The SSR installation orientation is horizontal and is not in an orientation for natural convection (bottom to top).

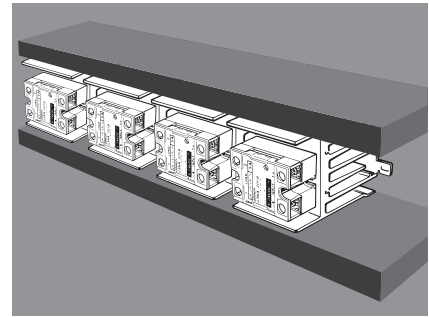

Example 2

Too many SSRs are arranged with close mounting.

The wiring duct impedes natural convection.

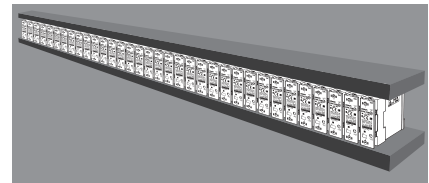

5. Ventilation and heat build up around the SSR

If the ventilation inside the panel is impeded by the devices inside the panel or by the wiring ducts, the build up of heat may cause the ambient temperature of the SSR to rise.

Also, if a heat source is present near the installation location, distance the heat source from the installation location.

6. Ambient temperature of the SSR

Basically, SSRs use natural convection to dissipate heat.

The ambient temperature of the SSR is the temperature of the air in which the SSR dissipates heat.

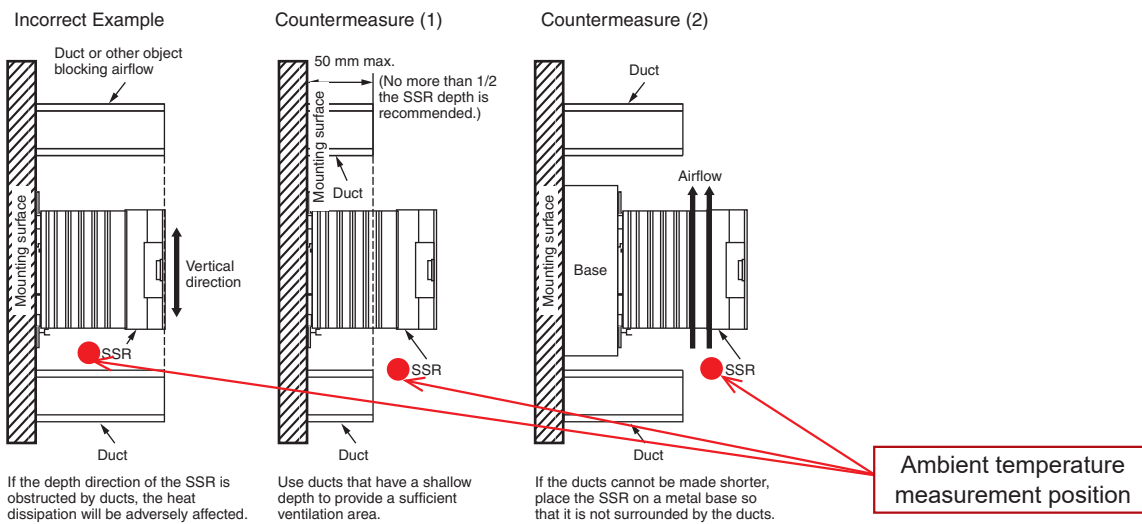

Solution

1. Follow the usage conditions and precautions clearly listed in the catalog and specifications when using the SSR.
2. Install the SSR with conditions that do not exceed those listed under "Load current vs. ambient temperature rating," that have a sufficient safety factor, and that are sufficiently flexible.
3. When laying out the control panel, design the heat dissipation using natural convection as the basic concept.

Overheating due to Inadequate Control Panel Heat Dissipation

- 1) SSRs generate heat for the loss corresponding to the carry current times the ON voltage drop.
- 2) If the heat dissipation is not appropriate, the internal temperature exceeds the prescribed value, which may lead to (1) an element fault, (2) decreased service life, and (3) the generation of smoke and fire.

Likely Causes

Heat dissipation is performed by way of (1) convection, (2) transmission, and (3) radiation, but (1) convection is the main method used by SSRs.

1. Heat dissipation failure due to the impeding of convection

- (1) Horizontal installation of SSRs
- (2) Obstructing of heat sinks with wiring ducts
- (3) Incorrect placement of ventilation fans in control panels
- (4) Ventilation fan and air inlet filter clogging
- (5) Ventilation fan fault
- (6) Air outlet obstruction due to close installation of devices
- (7) Close mounting exceeding the prescribed conditions

2. Heat dissipation failure due to the impeding of transmission

- (1) No thermal grease applied when mounting the SSR on the heat sink

3. Heat interference from another heat source

- (1) Mounting the SSR on the rear surface of a heater
- (2) Mounting the SSR close to a heat-generating element (such as a transformer or an inverter)

Example

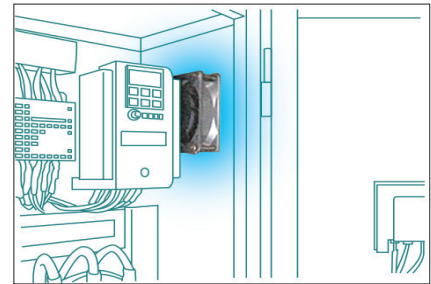

Inappropriate installation location for the ventilation fan

- Convection is impeded by this device, so the fan's function cannot be fully utilized.

Solution

1. Design solution

To solve causes 1-(1), 1-(2), 1-(3), 2, and 3, consider the problem during the design stage.

2. Usage solution

Perform periodic maintenance such as cleaning the filter.

m e m o

A series of horizontal dashed lines for writing.

Burn Damage

Burn damage is caused by problems such as overvoltage, overcurrent, and insufficient heat dissipation.

(Flame-retardant materials are used to construct SSRs, so the burn damage described in this section does not refer to damage caused by the SSR catching fire and burning continuously.)

Likely Causes

Abnormal heat generation and deterioration of insulation

Abnormal heat generation from the output elements or their surrounding area and the deterioration of the insulation may lead to the area surrounding the output elements melting, smoke being generated, and—in the worst case—burn damage.

◆ Conditions that make it easy for burn damage to occur
Generally, burn damage is caused by abnormal heat generation from the output elements or their surrounding area. It is easy for burn damage to occur under the following conditions.

- (1) Usage that exceeds the maximum value (rating) on the output side, interphase insulation failure due to causes such as the surge voltage of the load, and output element short-circuiting
- (2) Supplying to the output side power that exceeds the maximum value (prescribed value) of the load current or that has a short-circuit current
- (3) Interphase or input/output insulation deterioration due to the accumulation of dust inside the SSR when it is used after exceeding its life expectancy

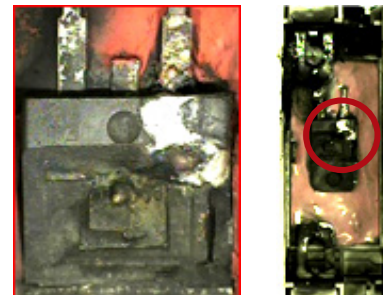

Magnified photograph of a switching element

Follow the usage conditions clearly listed in the catalog and specifications when using the SSR.

An example using the G3PE is explained below.

Abnormal heat generation

- If no interval is prescribed in the catalog, ensure there is a space of 10 mm between SSRs.



● Ventilation outside the control panel

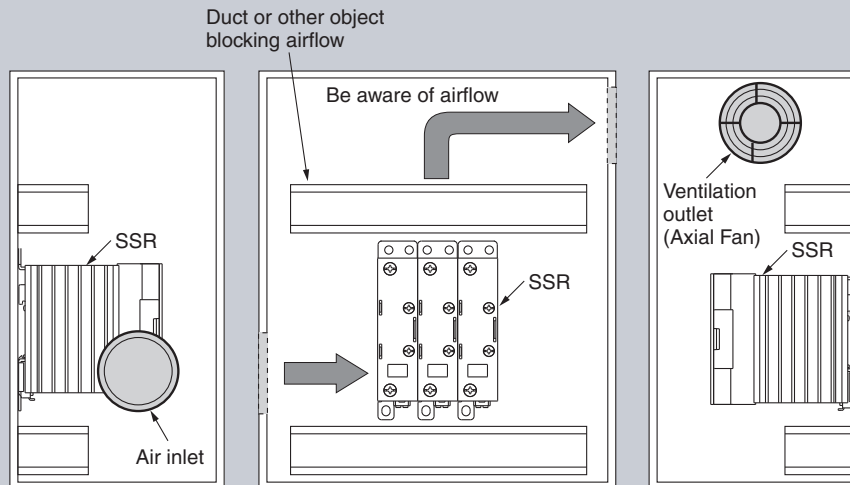

- Note: 1. If the air inlet or air outlet has a filter, clean the filter regularly to prevent it from clogging to ensure an efficient flow of air.
 2. Do not locate any objects around the air inlet or air outlet, otherwise the objects may obstruct the proper ventilation of the control panel.
 3. A heat exchanger, if used, should be located in front of the G3PE to ensure the efficiency of the heat exchanger.

● Relationship between the G3PE and ducts or other objects blocking the airflow

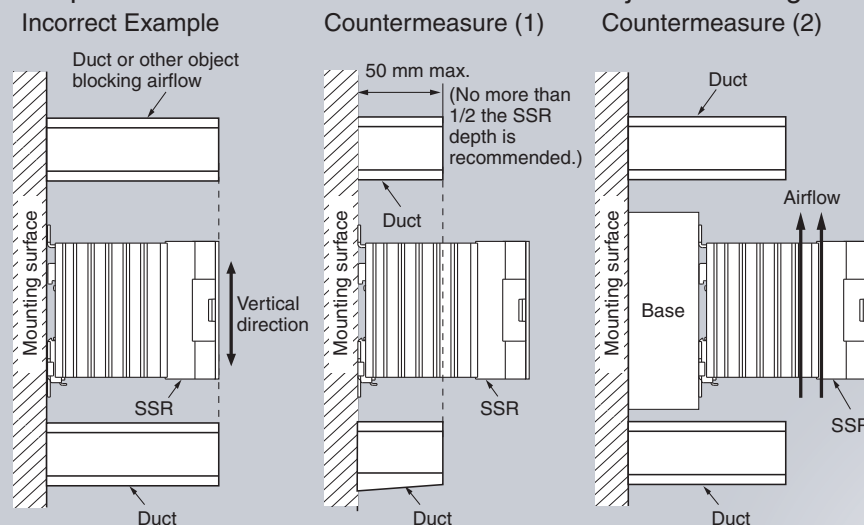

If the depth direction of the G3PE is obstructed by ducts, the heat dissipation will be adversely affected.

Use ducts that have a shallow depth to provide a sufficient ventilation area.

If the ducts cannot be made shorter, place the G3PE on a metal base so that it is not surrounded by the ducts.

Fault due to Three-phase Load Overcurrent

This fault leads to the abnormal heat generation or burn damage of products.

Likely Causes

The method being used to calculate the current may not match the heater connection method. The table below shows the current when using a 200 V, 1 kW, 5 A heater in single- or three-phase mode. Note that the calculation differs depending on whether the load is balanced or not.

		Normal operation	Fault	
Single phase				
Three phase	Delta connection			
	Star connection			
	Open delta connection			

Note: The currents are when using a 200 V, 1 kW heater in single-phase or three-phase mode.

Solution

The current may increase depending on the heater's connection method. Use the information provided here as a reference when determining the established operating current. Using a calculation that does not match the wiring method may lead to SSR damage. Select an SSR product that has a rated current that safely exceeds the calculated result.

(1) Single-phase current calculation (normal operation)

$$I (A) = P (W) / V (V) = 1000 \text{ W} / 200 \text{ V} = 5 \text{ A}$$

(2) Delta connection calculation (heater delta connection with 5 A/wire)

$$I (A) = P (W) / V (V) = 1000 \text{ W} / 200 \text{ V} = 5 \text{ A}$$

$5 \text{ A} \times \sqrt{3} = 8.7 \text{ A}$. It is necessary to select an SSR with an amperage greater than or equal to this value.

(3) Star connection calculation (heater star connection with 5 A/wire)

$$I (A) = P (W) / V (V) = 1000 \text{ W} / 200 \text{ V} = 5 \text{ A}$$

$5 \text{ A} \times 1 / \sqrt{3} = 2.9 \text{ A}$. It is necessary to select an SSR with an amperage greater than or equal to this value.

(4) Open delta connection calculation (neutral point current value during a heater open delta connection with 5 A/wire)

$$I (A) = P (W) / V (V) = 1000 \text{ W} / 200 \text{ V} = 5 \text{ A}$$

$5 \text{ A} \times \sqrt{3} = 8.7 \text{ A}$. It is necessary to select an SSR with an amperage greater than or equal to this value.

SSR Life Expectancy

The life expectancy of SSRs is determined by the deterioration of their compositional materials and joints (soldered parts).

Using SSRs correctly improves their reliability and lengthens their service lives.

How to Think About Life Expectancy and Maintenance

Unlike standard relays, an SSR uses a semiconductor to switch a circuit and does not contain mechanical contacts. Furthermore, signal transfer is handled by electronic circuits, so there are no moving parts to cause mechanical friction.

Therefore, to determine the life expectancy of an SSR, you must consider not only the life expectancy of the elements used but also the deterioration of soldered points and the materials of which the SSR is made.

OMRON generally considers the life expectancy of an SSR to be the point on the bathtub curve where the fault rate begins to rise and enters the wear-out fault period (for an SSR, this is the period when deterioration begins), which is approximately 10 years, although it will depend on the application environment.

Bathtub curve for electronic components and devices

Electronic components and electronic devices all experience characteristic changes, such as the deterioration of the materials they are composed of and their joints or reduced LED light-emitting efficiency due to heat stress caused by years of temperature changes in the surrounding environment and heat generated by their components, even if they are used properly.

Therefore, in most cases the fault rate of electronic components and devices follows a bathtub curve after they are shipped.

The life expectancy of an SSR can also be represented by a bathtub curve.

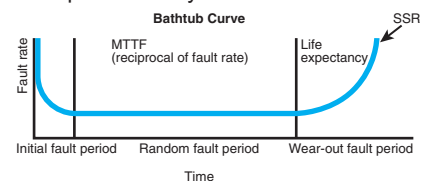

(1) Initial fault period

This is the period during which the fault rate (due to poor design, manufacturing defects, or random faults in components) decreases.

(2) Random fault period

This is the period in which the fault rate remains steady.

(3) Wear-out fault period

This is the period during which the fault rate increases.

Life expectancies (expected value) of SSRs

OMRON designs SSRs to have a life expectancy of at least 10 years if used as rated.

* The life expectancy is based on OMRON's testing standards. The actual service life will depend on the application environment.

Maintenance Guideline

Items to use as a reference in determining the maintenance period are shown below.

The reliability of SSRs can be improved by understanding their application environments (such as the heat dissipation environment) and by using SSRs correctly. Therefore, we recommend that you perform periodic inspections and maintenance.

Bathtub curve fault pattern	Cause	Cause of fault	Maintenance method	Maintenance period guideline	Remarks
Initial or random fault period	Load	Overvoltage • Lightning surge or counter-electromotive voltage etc. Overcurrent • Startup current, load short, or earth fault etc.	Replace the SSR.	When the fault occurs	
	Deterioration of application environment (temperature conditions)	Deterioration of heat dissipation environment • Blockage of ventilation holes • Fault in ventilation fans, panel coolers, etc. • Dirt on heat sinks (fins) for SSRs. etc.	Maintenance of heat dissipation environment with periodic inspection and cleaning * If the heat dissipation environment continues to worsen, it could accelerate further deterioration or metal fatigue.	— * Determine the maintenance period based on the application environment.	First, the heat dissipation environment of the application location must be understood. • Installation conditions, ambient temperature, and environment • Layout in which consideration is given for air convection etc.
	Random faults in electronic components	Random faults in electronic components (semiconductors) • Manufacturing defects or early faults in the components (electronic components) being used	Replace the SSR.	When the fault occurs	
	Manufacturing defects	Manufacturer-caused defects • Manufacturing defects during the manufacturing process • Faults resulting from design errors	Replace the SSR.	When the fault occurs	
Wear-out fault period	Insulation deterioration	Insulation deterioration resulting from dirt around the SSR terminals * High humidity can worsen insulation deterioration.	Maintenance of insulation performance with periodic inspection and cleaning	— * Determine the maintenance period based on the application environment.	
	* Metal fatigue or solder deterioration of joints	Materials with different thermal expansion coefficients are bonded together. Therefore, the buildup of stress resulting from long-term temperature fluctuations results in metal fatigue.	Replace the SSR.	10 years * Periodic inspection that is appropriate for the application environment is recommended.	This depends on the application environment such as the heat dissipation environment and the load ratio.

* SSRs do not suffer faults due to wear, so the fault period due to changes over time is shown here.

SSR Selection Points

There are five points related to maintaining the high reliability of a solid state relay (SSR) and using it for a long period of time. Consider factors such as the loads being switched between and the application environment when selecting an SSR.

- 1) The effect of minimizing inrush current and noise → Zero cross function (For AC loads, consider this during selection.)
- 2) Characteristic that affects the life expectancy → The load current vs. ambient temperature rating (common between SSRs)
- 3) Characteristic that affects the withstand inrush current → Withstand inrush current (especially for inductive loads and transformer loads)
- 4) Characteristic that affects the control of microloads → Minimum load current (especially for the input signals of devices such as PLCs)
- 5) Improvement of the withstand external surge voltage → Explanation of the surge pass function (This function is especially effective with heater loads.)
- 6) Basic configuration

SSR Selection Points

1. Zero cross function

Effect: This function has the effect of minimizing inrush current and noise with AC loads.

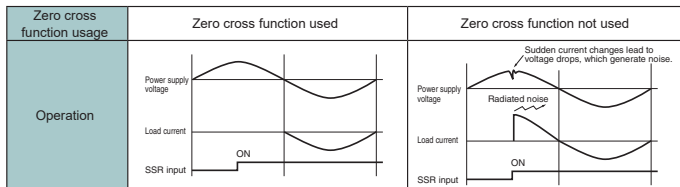

As shown in the figure on the left, turning ON (operating) the SSR with the load voltage close to zero volts reduces the inrush current or noise that is generated due to the rising edge of the inrush current that occurs when the AC load starts.

Supplemental Related article: **CASE 09**

When using an SSR with a half-wave rectified inductive load, use an SSR without a zero cross function.

2. [Load current vs. ambient temperature] rating

Effect: Use SSRs as rated. Reducing the temperature increase within the control panel extends the life expectancy of the SSR.

1) SSRs integrated with heat sinks

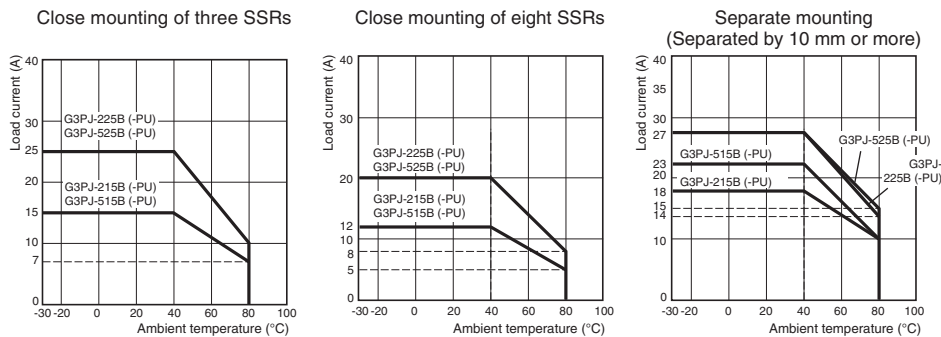

The current that an SSR causes to flow varies depending on the temperature within the control panel that is being used or within the device in which the SSR is embedded (the ambient temperature).

Using an SSR under conditions that exceed the [load current vs. ambient temperature rating] may lead to the SSR suffering early faults.



Supplemental Related article: **CASE 10 CASE 11 CASE 13**

Note that continuously using an SSR in a state in which the [load current vs. ambient temperature rating] is exceeded due to the deterioration of the heat dissipation conditions or inadequate installation conditions (such as the air convection that is required to dissipate the heat) may lead to SSR faults or burn damage.

2) SSRs with separate heat sinks

G3NA Series
Example of an SSR with a separate heat sink

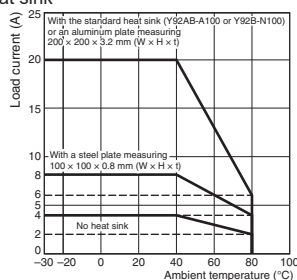

The load current for SSRs with separate heat sinks is the specification for the case in which the heat sink is installed.

Note that the load current that flows when the heat sink is not installed is lower.

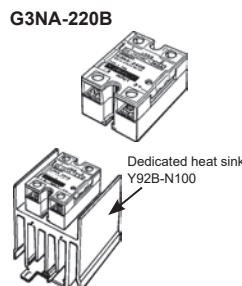

3) Ambient temperature measurement points

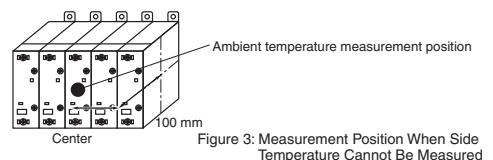
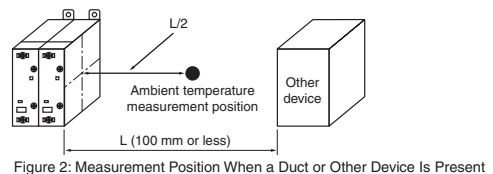
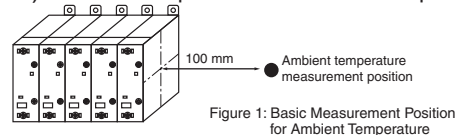

3. Withstand inrush current

Effect: Withstands the inrush current, which provides a guideline for the selection of protective devices.

This mainly withstands the inrush current that occurs when an AC inductive load is started. Select an SSR so that the load's inrush current does not exceed the [repetition] rating.

Supplemental

Related article: **CASE 01**
This requires special attention when using an SSR with an AC inductive load. Be sure to check this item closely.

G3NA Series
Rated load current 20 A type example

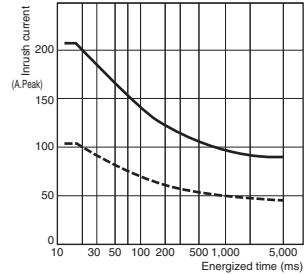

4. Minimum load current

Effect: This has the effect of preventing malfunctions with microloads (malfunctions caused by leakage current).

G3RZ Series

Check the minimum value listed for the [load current] item.

■ Ratings

Model	Item	Input				Output			
		Rated voltage	Operating voltage	Impedance	Voltage level Operating voltage Release voltage	Rated load voltage	Load voltage range	Load current*	Inrush current injection amount
G3RZ-201SLN	5 VDC	4 to 6 VDC	400 Ω ± 20%	4 VDC max.	1 VDC min.	5 to 240 VAC 5 to 100 VDC	3 to 264 VAC 3 to 125 VDC	100 μA to 1.0 A	10 A (10 ms)
	12 VDC	9.6 to 14.4 VDC	1.1 kΩ ± 20%	9.6 VDC max.					
	24 VDC	19.2 to 28.8 VDC	2.2 kΩ ± 20%	19.2 VDC max.					

* This varies depending on the ambient temperature.

When switching between inputs (such as for PLCs) or between minimal loads (such as for signals), select an SSR that has a small minimum load current. If the minimum load current is smaller than the minimum load, malfunctions may occur.

SSRs appropriate for microloads: plug-in SSRs/terminal SSRs

■ Typical SSR models for use with microloads

Model	Minimum load current	AC load	DC load	
G3RZ-201SLN	100 μA	•	•	G2R-1-S shapes plug-in SSR
G3FM-2R5SLN	1 mA	•	•	MY2 shapes plug-in SSR
G3DZ-F4B	100 μA	•	•	Four-point terminal SSR

5. Surge pass function

Effect: This function reduces SSR faults caused by external surges.

Surge pass function principle

This is a protective function of SSRs dedicated for use with heaters.

G3PE output circuit illustration

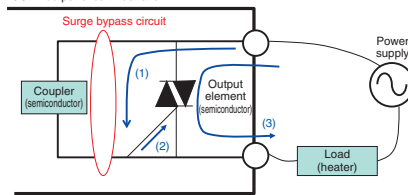

Assume that an excessive surge voltage is superimposed on the load power supply line.

Momentarily turning ON the SSR reduces the risk of an output element fault occurring due to the surge energy.

Surge pass function operation

- When surge voltage is applied to the output circuit of the SSR, current flows to the drive circuit (gate circuit) of the output element by way of the surge bypass circuit.
- The current from step 1. causes the output element to turn ON momentarily.
* The ON time is just a half wave of a commercial power supply.
60 Hz: approximately 10 ms/50 Hz: approximately 8 ms
- Momentarily turning ON the output element greatly reduces the surge energy that is applied to the output circuit of the SSR.

Supplemental

Related article: **CASE 04**

This requires special attention when using an SSR with a DC inductive load.

Be sure to check this item closely.

Caution

Products equipped with the surge pass function are SSRs specially designed for use with heaters. They cannot be used with inductive loads for which a problem occurs when they are turned ON for a half cycle such as lamps, motors, and valves.

6. Basic configuration

SSRs receive voltage pulses (such as 12 VDC) from a device such as a temperature controller and turn load circuits ON and OFF. To select a product, the SSR input voltage and input current information is necessary.

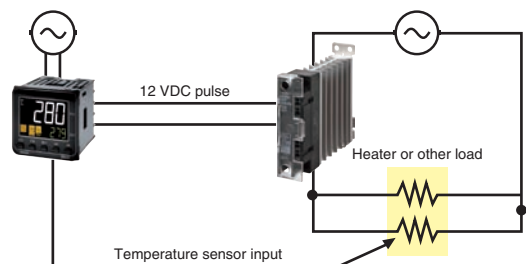

List of SSR Defect Causes (1) [Extended Load Operation (Intermittent Load Operation)]

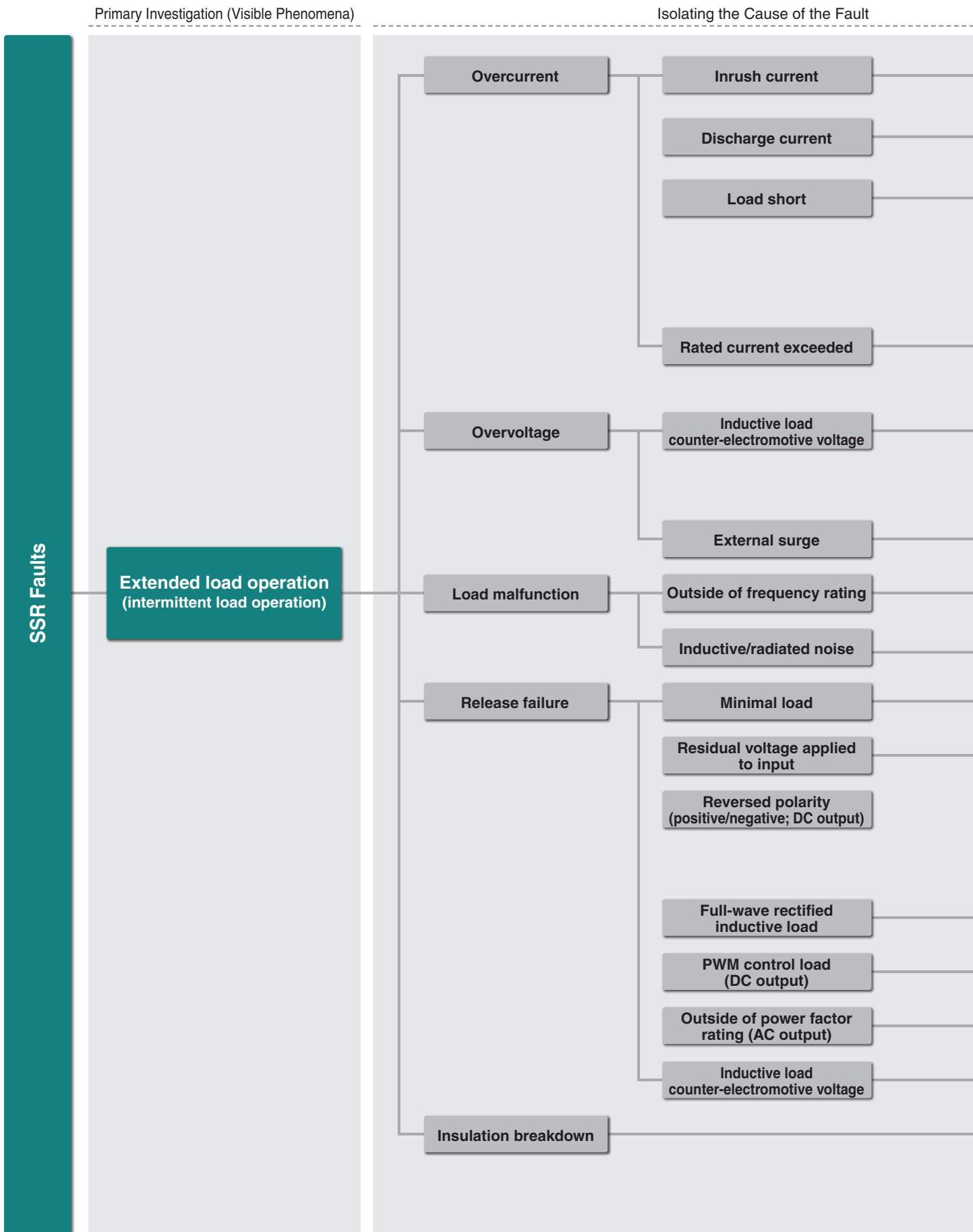

Faults

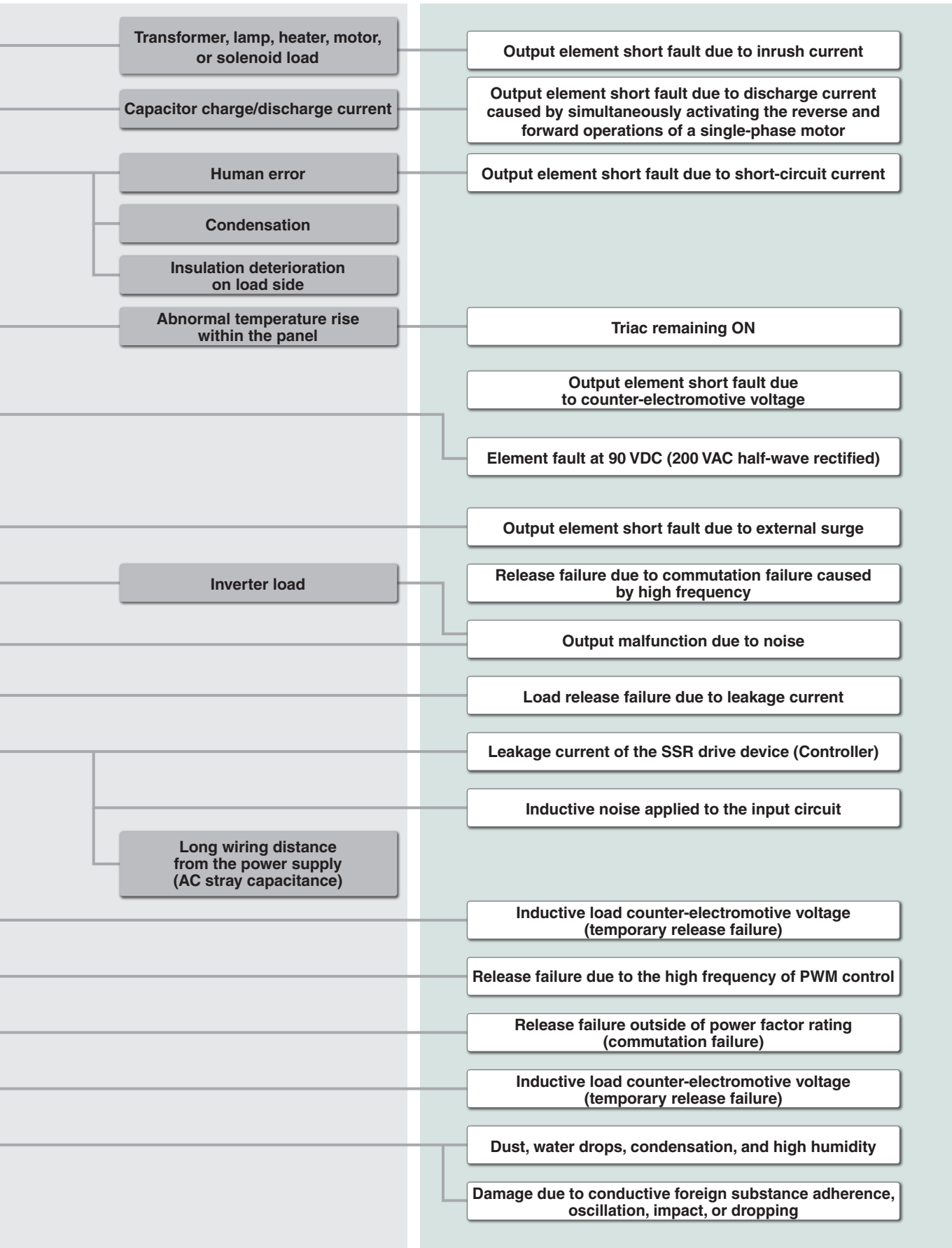

List of SSR Defect Causes (2) [Failure of Load to Operate (Intermittent Shutting OFF of Loads)]

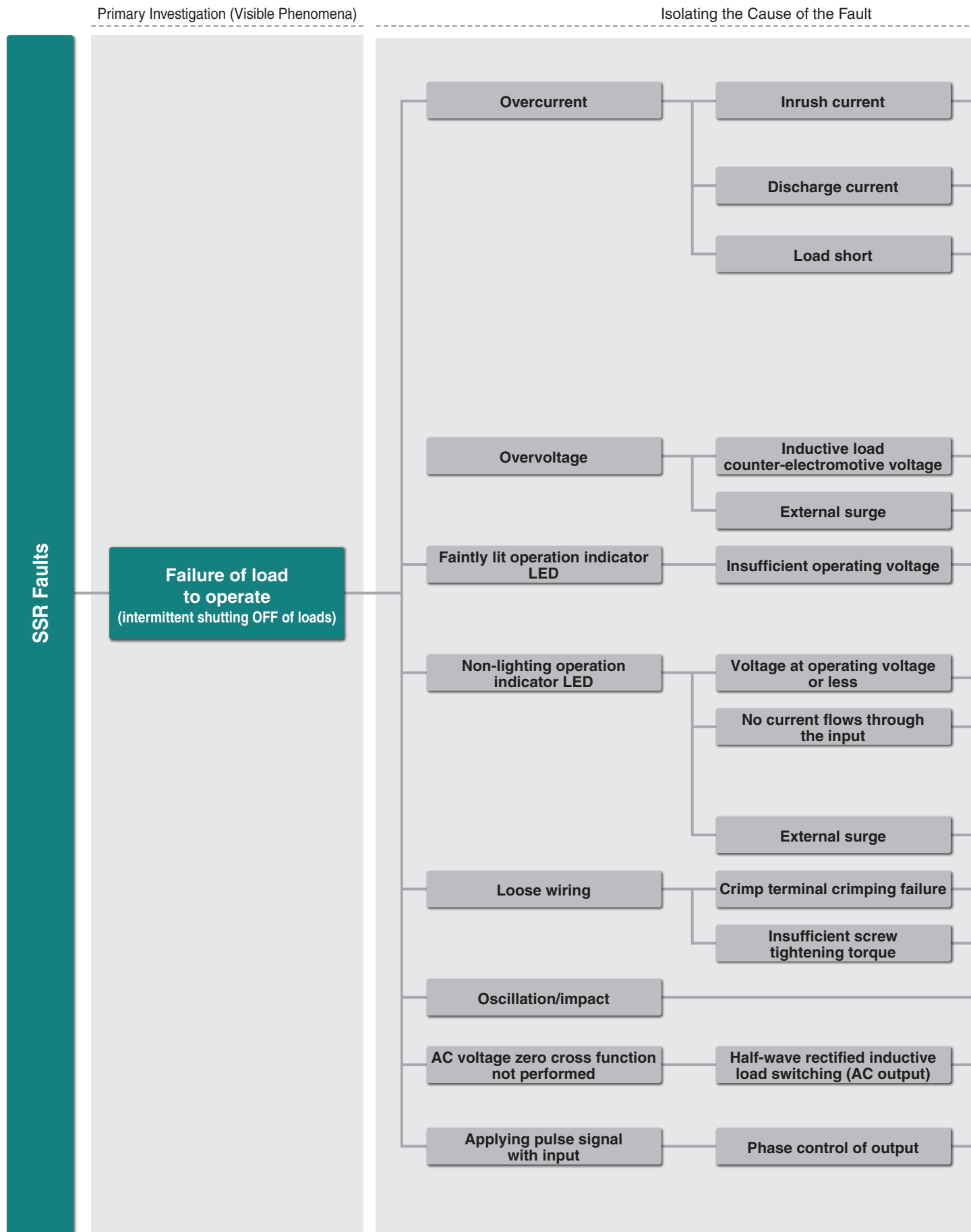

Faults

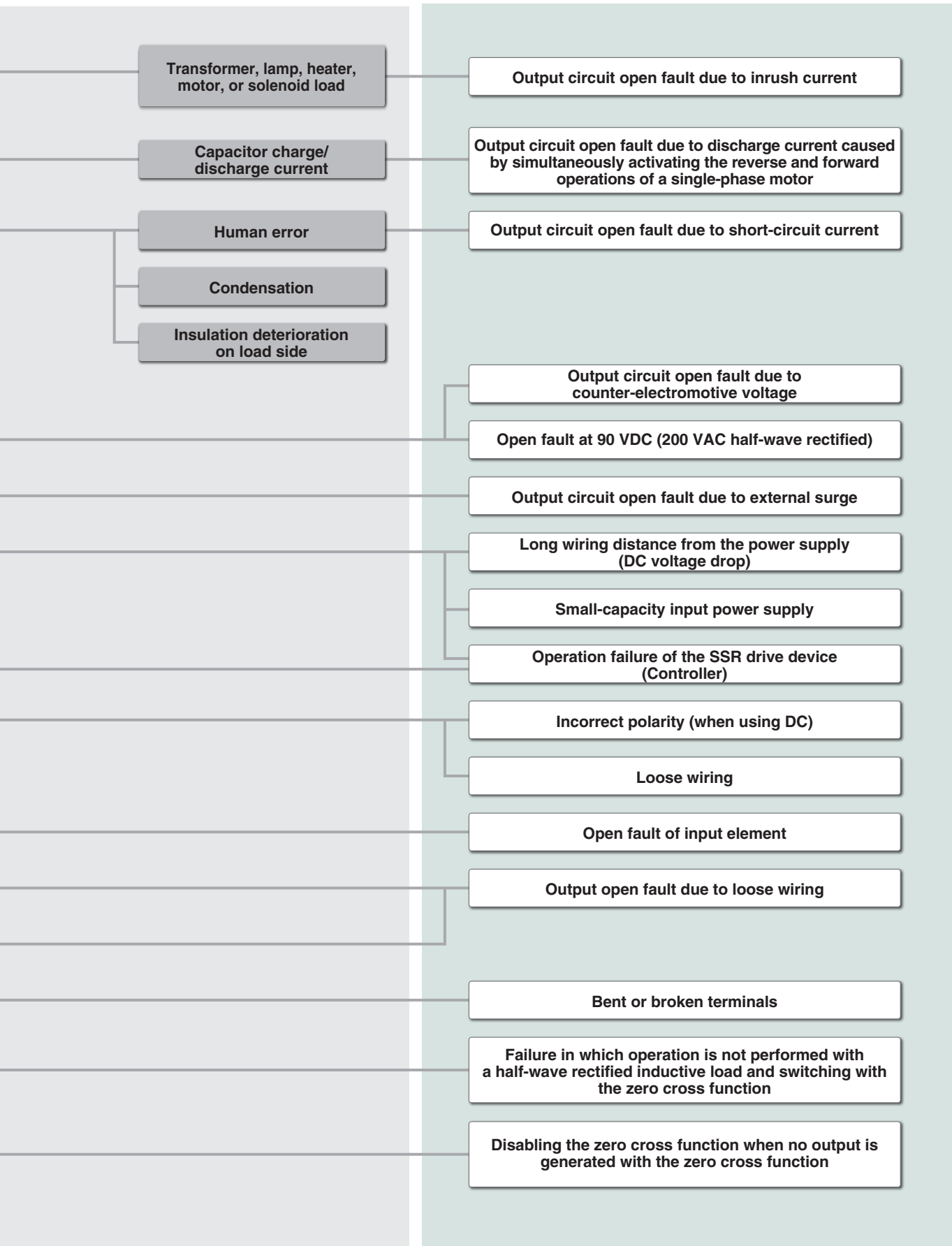

List of SSR Defect Causes (3) [Other Phenomena]

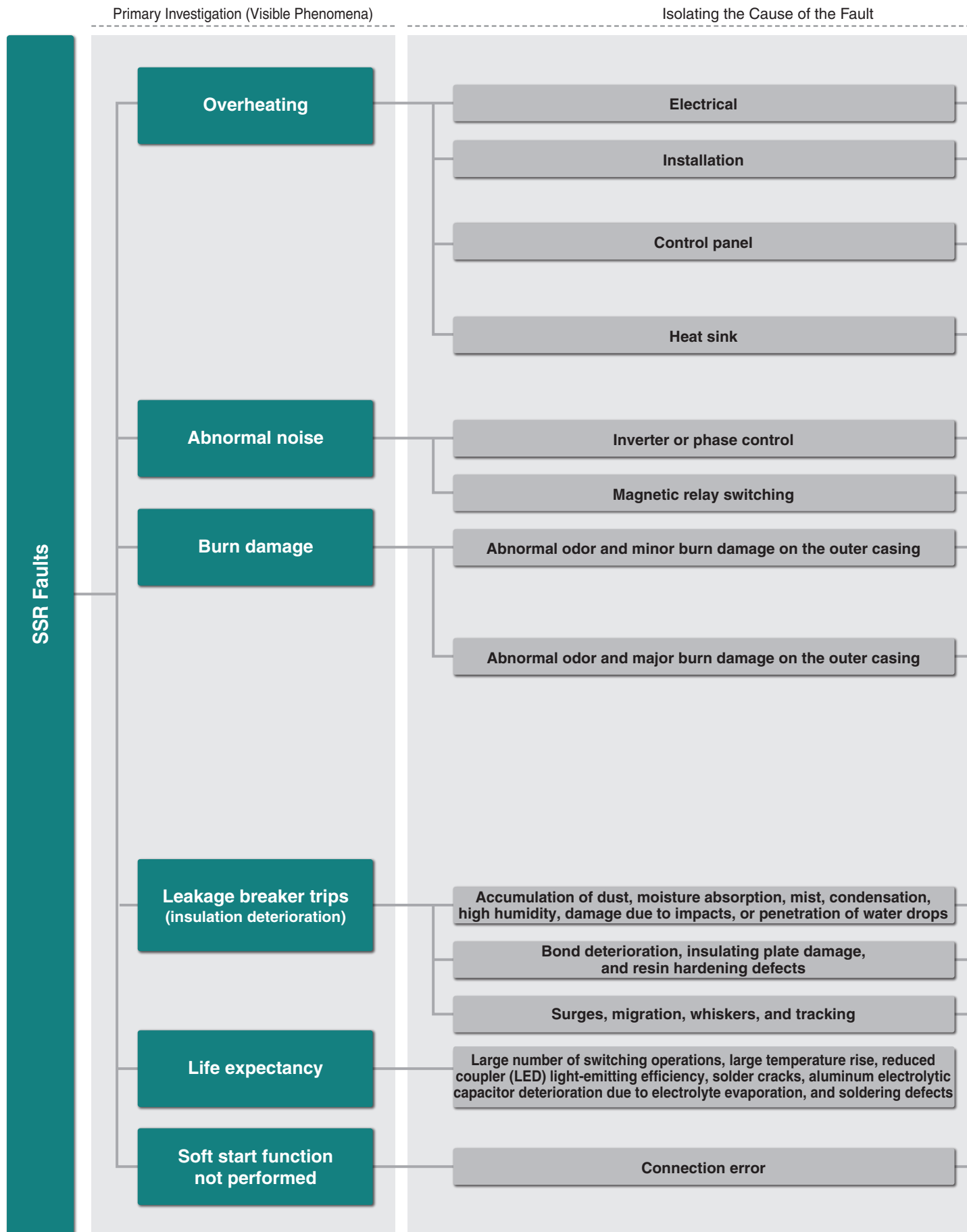

Faults

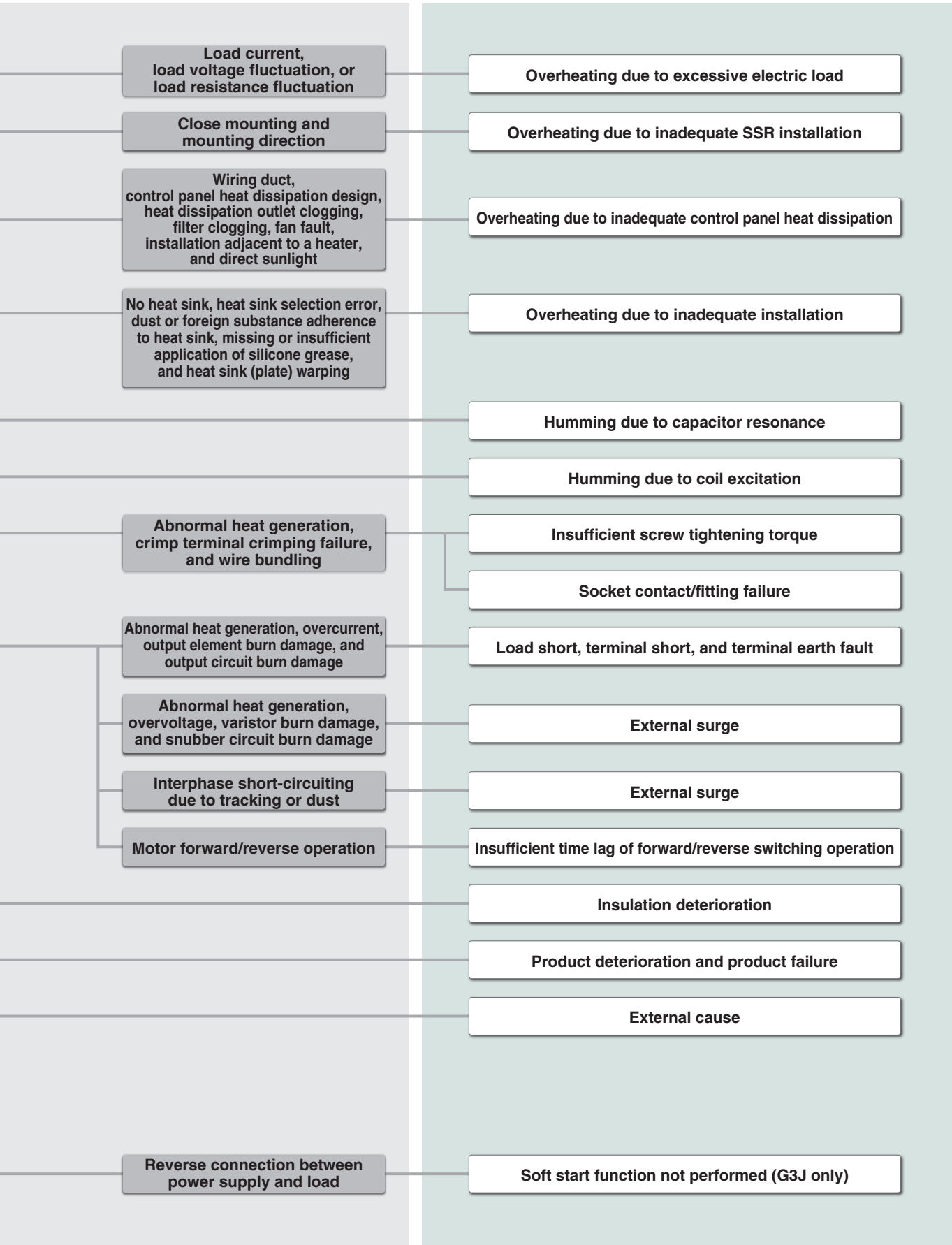

Solid State Relays with the Same Shapes as General-purpose Relays

Recommended Selections

These solid state relays have the same shape as OMRON's general-purpose relays such as MY, LY, MK, G2R, and G7T and are suitable for high-frequency switching, signal exchange with controllers, and other I/O applications.



*1: Board-mounted G3R Relays are also available. For details, refer to OMRON's general catalog for electronic and mechanical parts.

*2: These are hybrid relays that combine mechanical relays and SSRs.

Same shape as the G7T

I/O Solid State Relays

G3TA

For AC or DC loads

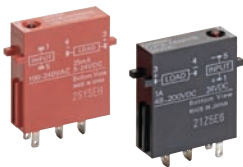

- Input application: For current loads from 0.1 to 25 mA.
- Output application: For current loads from 1 to 2 A.

Same shape as the MK

Solid State Relays

G3B/G3BD

For AC loads For DC loads



- For current loads from 3 to 5 A.

Same shape as the G2RV-ST

Slim I/O Solid State Relay

G3RV-ST

For AC loads For DC loads



- Low profile type with a width of 6.2 mm.
- Push-In Plus terminal block socket.
- For current loads from 2 to 3 A.

Push-In Plus

Push-In Plus

Terminal Block Reduces Wiring Work



Requires just one hand!

Easily inserted just like an earphone jack. Wiring is simple and can be performed with a single action.



Even crossover wiring is smooth!

Two terminals that are expected to be used in co-fastening are provided. One wire is connected to one terminal, which eliminates the need to perform troublesome co-fastening.

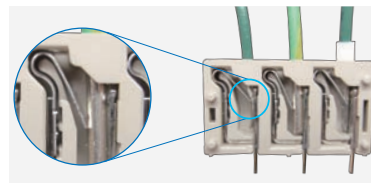

No extra tightening required!

Terminals and wires are fixed in place not with screws but with clamp spring pressure. This eliminates concerns regarding screws coming loose.

Recommended Selections

Ideal for high-precision, high-frequency control of reflow, molding machines, furnaces, etc. A wide lineup of models for load currents from 5 to 150 A to meet your needs. Many models are available with fault detection.

SSRs with Separate Heat Sinks

Solid State Relays G3NA



- Models from 5 to 90 A.
- Industrial-standard mounting pitch.

SSRs with Integrated Heat Sinks

Solid State Relays G3PE (Single Phase)



- Models from 15 to 45 A.
- Slim width of 22.5 mm for 25 A.

Faston terminals

Slim design models

Three-phase circuit

Solid State Relays G3NE



Enables wiring with Faston terminals.

Solid State Relays G3PJ



Slim design models with close mounting.
Models available with Push-In Plus terminal blocks (for input only).

Push-In Plus

Solid State Relays G3PE (Three Phase)

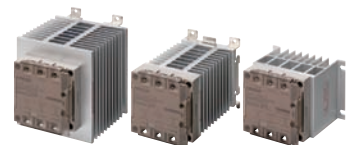

Integrated three-phase SSRs.
Three- or two-phase applications also possible.

Push-In Plus

Terminal Block Reduces Wiring Work



Requires just one hand!

Easily inserted just like an earphone jack. Wiring is simple and can be performed with a single action.



Even crossover wiring is smooth!

Two terminals that are expected to be used in co-fastening are provided. One wire is connected to one terminal, which eliminates the need to perform troublesome co-fastening.

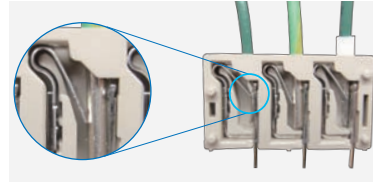

No extra tightening required!

Terminals and wires are fixed in place not with screws but with clamp spring pressure. This eliminates concerns regarding screws coming loose.

Higher power current rating

Easier maintenance

Alarms

**High-power Solid State Relays
G3PH**

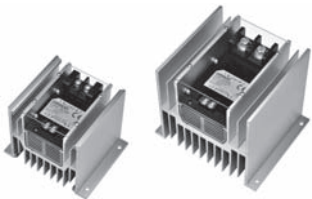

High power current rating:
75 or 150 A.

**High-power Solid State Relays
G3PA**



Easy maintenance by simply replacing the output element (Power Device Cartridge).

**Solid State Relays with Built-in CTs
G3PF**



- Built-in CT for less wiring work.
- Heater burnout detection and alarm output.
- SSR fault detection (open/short).

Temperature Controllers (Panel mount type)

Recommended Selections

Wide lineup that supports various applications such as food machinery, packaging machines, molding machines, and semiconductor manufacturing equipment. Panel mount type that is installed on the control panel and can be easily set with an easy-to-read display is available.

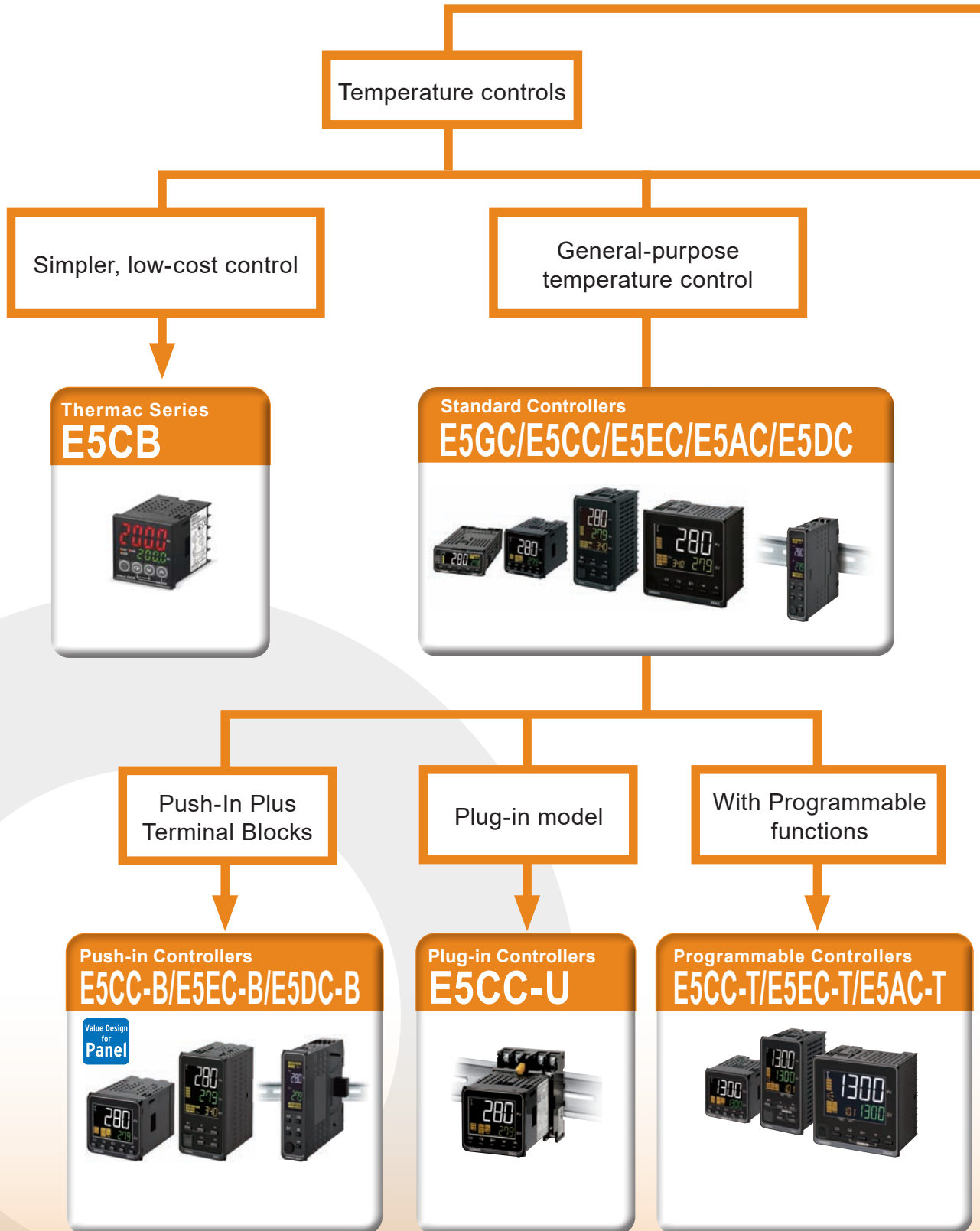

Panel mount type

Temperature alarms

Simpler High control performance

Higher precision control
Displays down to 0.01°C

Standard Plus
E5CD/E5ED



Two black panel-mount temperature controllers with digital displays showing 13.00.

Thermac NEO
E5CN-H/E5EN-H/E5AN-H



Three black panel-mount temperature controllers with digital displays showing 20.00.

Temperature Alarm Devices
K8DT-TH



Value Design for Panel

Push-In Plus Terminal Blocks

Push-In Plus Terminal Blocks

Push-in Controllers
E5CD-B/E5ED-B



Value Design for Panel

Two black panel-mount push-in temperature controllers with digital displays showing 13.00.

OMRON provides temperature sensors, non-contact temperature sensors, and temperature/humidity sensors as thermal input devices of Temperature Controllers to meet various applications.

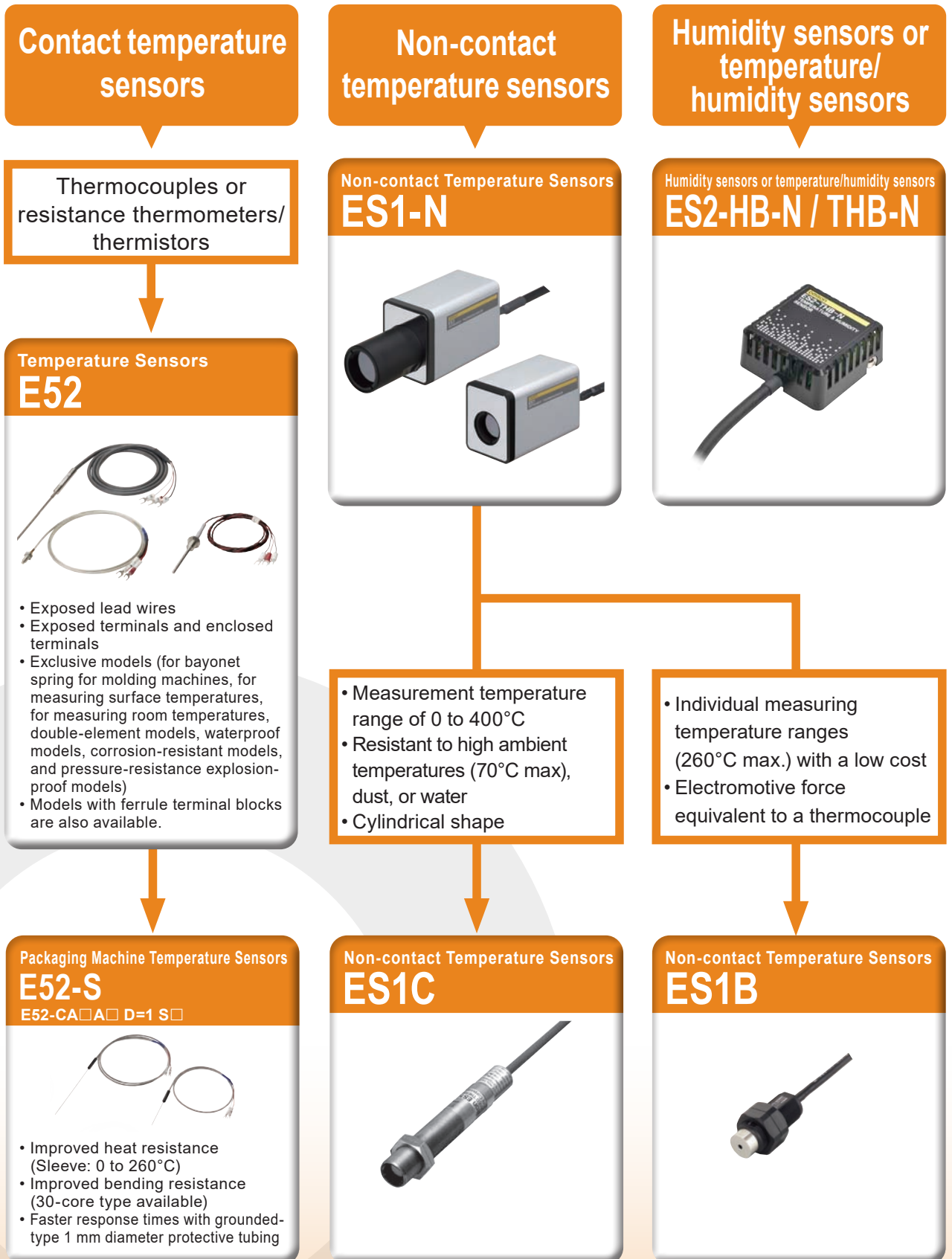

Terms and Conditions Agreement

Read and understand this catalog.

Please read and understand this catalog before purchasing the products. Please consult your OMRON representative if you have any questions or comments.

Warranties.

- (a) Exclusive Warranty. Omron's exclusive warranty is that the Products will be free from defects in materials and workmanship for a period of twelve months from the date of sale by Omron (or such other period expressed in writing by Omron). Omron disclaims all other warranties, express or implied.
- (b) Limitations. OMRON MAKES NO WARRANTY OR REPRESENTATION, EXPRESS OR IMPLIED, ABOUT NON-INFRINGEMENT, MERCHANTABILITY OR FITNESS FOR A PARTICULAR PURPOSE OF THE PRODUCTS. BUYER ACKNOWLEDGES THAT IT ALONE HAS DETERMINED THAT THE PRODUCTS WILL SUITABLY MEET THE REQUIREMENTS OF THEIR INTENDED USE.

Omron further disclaims all warranties and responsibility of any type for claims or expenses based on infringement by the Products or otherwise of any intellectual property right. (c) Buyer Remedy. Omron's sole obligation hereunder shall be, at Omron's election, to (i) replace (in the form originally shipped with Buyer responsible for labor charges for removal or replacement thereof) the non-complying Product, (ii) repair the non-complying Product, or (iii) repay or credit Buyer an amount equal to the purchase price of the non-complying Product; provided that in no event shall Omron be responsible for warranty, repair, indemnity or any other claims or expenses regarding the Products unless Omron's analysis confirms that the Products were properly handled, stored, installed and maintained and not subject to contamination, abuse, misuse or inappropriate modification. Return of any Products by Buyer must be approved in writing by Omron before shipment. Omron Companies shall not be liable for the suitability or unsuitability or the results from the use of Products in combination with any electrical or electronic components, circuits, system assemblies or any other materials or substances or environments. Any advice, recommendations or information given orally or in writing, are not to be construed as an amendment or addition to the above warranty.

See <http://www.omron.com/global/> or contact your Omron representative for published information.

Limitation on Liability; Etc.

OMRON COMPANIES SHALL NOT BE LIABLE FOR SPECIAL, INDIRECT, INCIDENTAL, OR CONSEQUENTIAL DAMAGES, LOSS OF PROFITS OR PRODUCTION OR COMMERCIAL LOSS IN ANY WAY CONNECTED WITH THE PRODUCTS, WHETHER SUCH CLAIM IS BASED IN CONTRACT, WARRANTY, NEGLIGENCE OR STRICT LIABILITY.

Further, in no event shall liability of Omron Companies exceed the individual price of the Product on which liability is asserted.

Suitability of Use.

Omron Companies shall not be responsible for conformity with any standards, codes or regulations which apply to the combination of the Product in the Buyer's application or use of the Product. At Buyer's request, Omron will provide applicable third party certification documents identifying ratings and limitations of use which apply to the Product. This information by itself is not sufficient for a complete determination of the suitability of the Product in combination with the end product, machine, system, or other application or use. Buyer shall be solely responsible for determining appropriateness of the particular Product with respect to Buyer's application, product or system. Buyer shall take application responsibility in all cases.

NEVER USE THE PRODUCT FOR AN APPLICATION INVOLVING SERIOUS RISK TO LIFE OR PROPERTY OR IN LARGE QUANTITIES WITHOUT ENSURING THAT THE SYSTEM AS A WHOLE HAS BEEN DESIGNED TO ADDRESS THE RISKS, AND THAT THE OMRON PRODUCT(S) IS PROPERLY RATED AND INSTALLED FOR THE INTENDED USE WITHIN THE OVERALL EQUIPMENT OR SYSTEM.

Programmable Products.

Omron Companies shall not be responsible for the user's programming of a programmable Product, or any consequence thereof.

Performance Data.

Data presented in Omron Company websites, catalogs and other materials is provided as a guide for the user in determining suitability and does not constitute a warranty. It may represent the result of Omron's test conditions, and the user must correlate it to actual application requirements. Actual performance is subject to the Omron's Warranty and Limitations of Liability.

Change in Specifications.

Product specifications and accessories may be changed at any time based on improvements and other reasons. It is our practice to change part numbers when published ratings or features are changed, or when significant construction changes are made. However, some specifications of the Product may be changed without any notice. When in doubt, special part numbers may be assigned to fix or establish key specifications for your application. Please consult with your Omron's representative at any time to confirm actual specifications of purchased Product.

Errors and Omissions.

Information presented by Omron Companies has been checked and is believed to be accurate; however, no responsibility is assumed for clerical, typographical or proofreading errors or omissions.

Product Catalogs for Control Panels

**Sockets, Slim I/O Relays,
I/O Relay Terminals
Push-In Plus Terminal
Block Series**
PYF-PU, P2RF-PU,
G2RV-SR/G3RV-SR, G70V, P7SA-PU



Cat. No. J213

**Switch Mode
Power Supplies**
S8VK-S



Cat. No. T206

**Measuring and
Monitoring Relays**
K8DT



Cat. No. N210

**Solid-state
Timers**
H3DT



Cat. No. M091

**Digital Temperature
Controllers**
E5_C series



Cat. No. H220

**Solid State Relays
for Heaters**
G3PJ



Cat. No. J211

**DIN Track
Terminal Blocks**
XW5T



Cat. No. G123

Power Monitors
KM-N2/KM-N3



Cat. No. N212

**Push-In Plus
Terminal Blocks Series
Pushbutton Switches**
A22N-P/A30N-P/M22N-P



Cat. No. A253

Note: Do not use this document to operate the Unit.

OMRON Corporation Industrial Automation Company

Kyoto, JAPAN

Contact : www.ia.omron.com

Regional Headquarters

OMRON EUROPE B.V.

Wegalaan 67-69, 2132 JD Hoofddorp
The Netherlands
Tel: (31) 2356-81-300 Fax: (31) 2356-81-388

OMRON ELECTRONICS LLC

2895 Greenspoint Parkway, Suite 200
Hoffman Estates, IL 60169 U.S.A.
Tel: (1) 847-843-7900 Fax: (1) 847-843-7787

OMRON ASIA PACIFIC PTE. LTD.

438B Alexandra Road, #08-01/02 Alexandra
Technopark, Singapore 119968
Tel: (65) 6835-3011 Fax: (65) 6835-3011

OMRON (CHINA) CO., LTD.

Room 2211, Bank of China Tower,
200 Yin Cheng Zhong Road,
PuDong New Area, Shanghai, 200120, China
Tel: (86) 21-6023-0333 Fax: (86) 21-5037-2388

Authorized Distributor:

©OMRON Corporation 2016-2023 All Rights Reserved.
In the interest of product improvement,
specifications are subject to change without notice.

Cat. No. Z385-E1-03 0623 (1216)