

Exceptional motion control capability maximizes machine performance

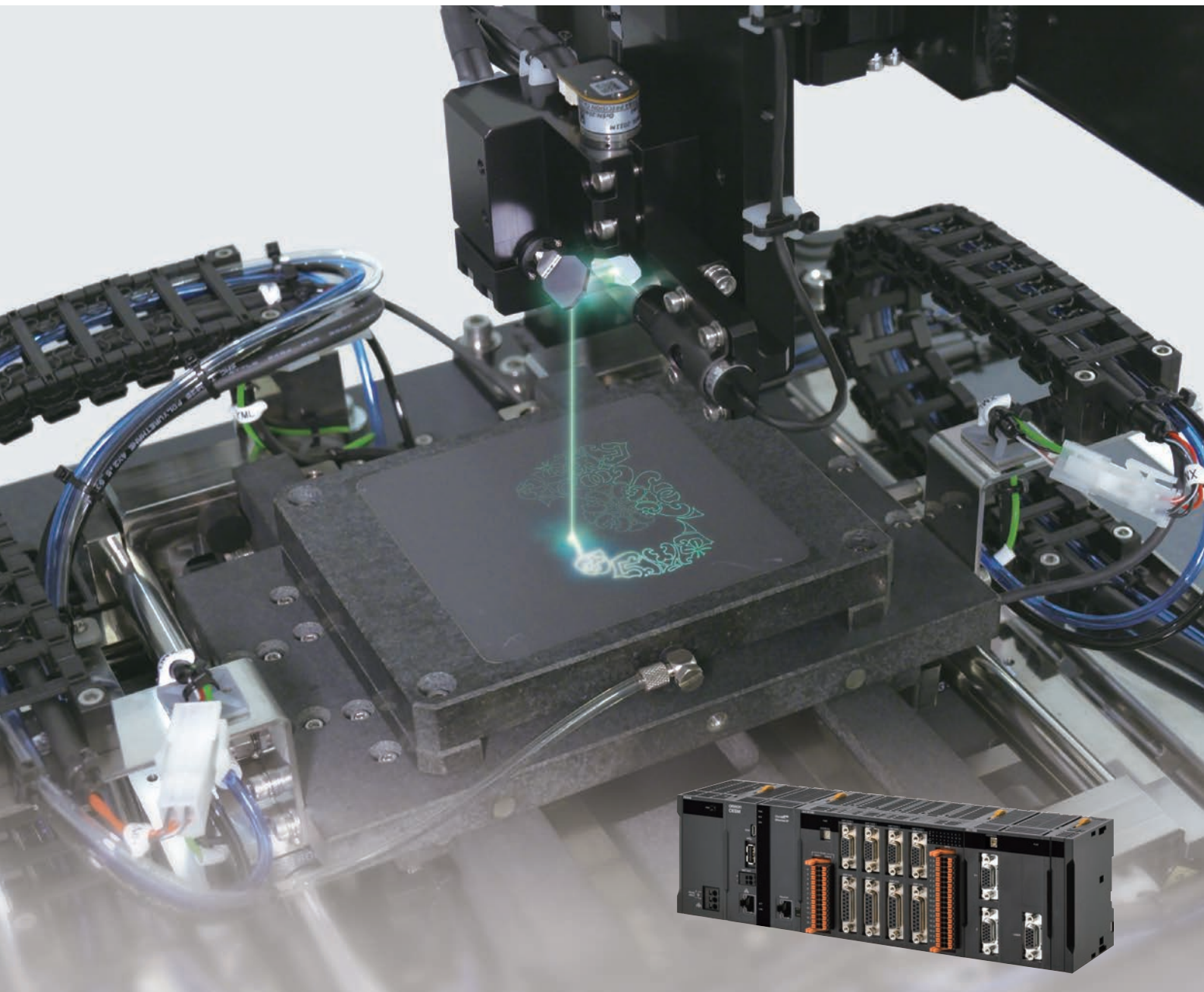

Are you concerned about your machine's performance?

Boost machine throughput to meet growing market demand

See Application >P.9

Perform high-precision three-dimensional machining for new items

See Application >P.10

Improve production quality

See Application >P.11

Solve motion control issues with four features and maximize machine performance

Omron now offers a next generation motion controller CK3M/CK5M Series that packs the superior motion control capability of PMAC (Programmable Multi Axis Controller) into its compact design.

Its four features-Rapid, Flexible, Capable, and Easy-increase both speed and precision, helping you obtain the best performance from your machine.

Rapid

Fast control cycle times for more precise machining

Flexible

Multi-vendor compatibility to optimize system configuration

Capable

Flexible development of various applications

Easy

Integrated system to reduce machine design time



Rapid Fast control cycle times for more precise machining

Calculation with a fastest servo cycle time of 25 μ s/5 axes*¹ enables high-precision command calculation and command following, increasing the precision of your machine.

*1. Motor control only. Omron survey as of November 2022.

High-speed command calculation for high-precision machining

Precise commands are crucial to precision machining.

The CK3M/CK5M Series can precisely calculate commands with a very fast control cycle time.

Motion PLC

The long control period and low-precision command calculation result in paths which are not ideal.

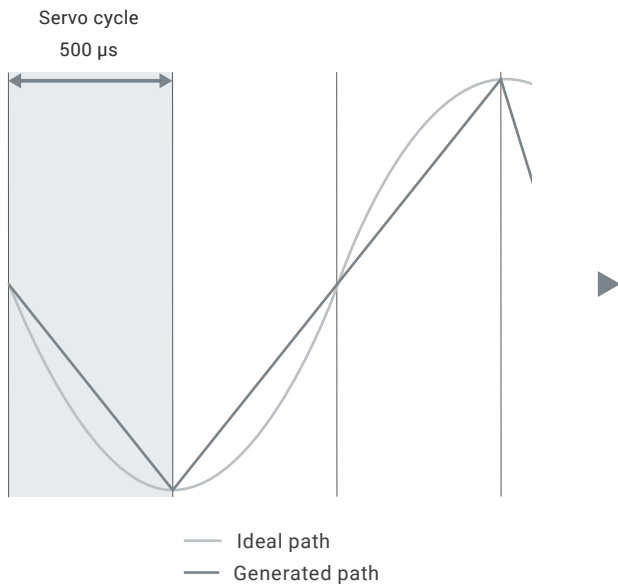

CK5M

Smooth command calculation with a very short control period enables ideal paths to be generated.

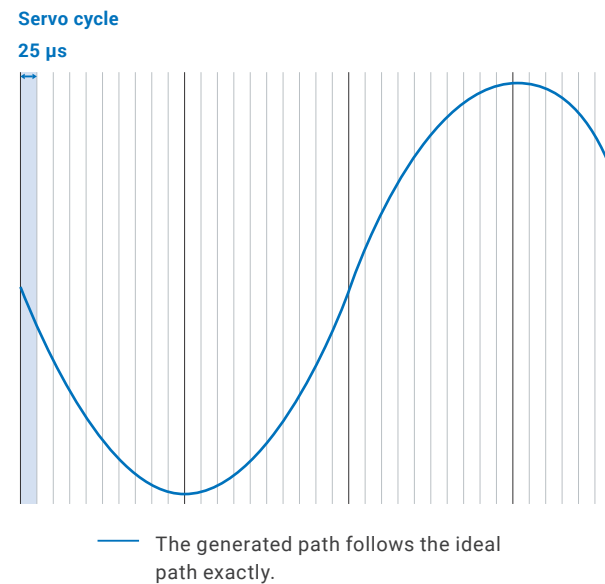

High-speed correction for high-precision machining

High-precision motion control can be achieved by following precise commands.

The CK3M/CK5M Series can drive actuators with a short control period, providing precise path control.

Motion PLC

High-precision control is impossible because a long control period hinders following precise commands.

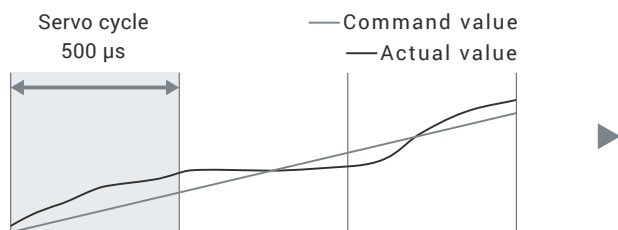

CK5M

The CK5M Series receives a feedback value and makes correction at a high speed, providing more precise path control.

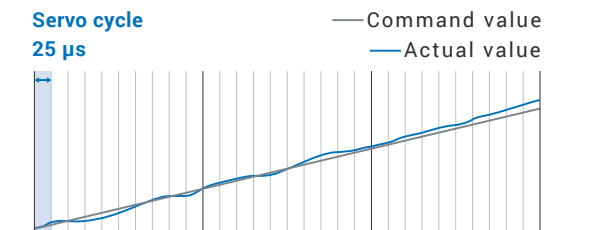

Flexible Multi-vendor compatibility to optimize system configuration

The CK3M/CK5M Series has multiple interfaces with multi-vendor actuators and encoders and control modes, allowing you to have freedom of choice in selecting the right devices to maximize your machine's performance.

A variety of interfaces to optimize system configuration

The input interface can accept the A/B phase signals, sinusoidal signals, and parallel binary signals, and axes can be controlled by analog commands (DAC) and Direct PWM*2. The interfaces with high-resolution encoders, linear motors, and galvo scanners allow you to freely choose the most suitable devices for your application. Furthermore, high-precision synchronous control between actuators enables precision machining.

*2. Omron's unique method to communicate between the Power PMAC and servo amplifiers.

Motion PLC

Fully synchronized control is difficult because multiple controllers are used. Available actuators are limited depending on the controller.

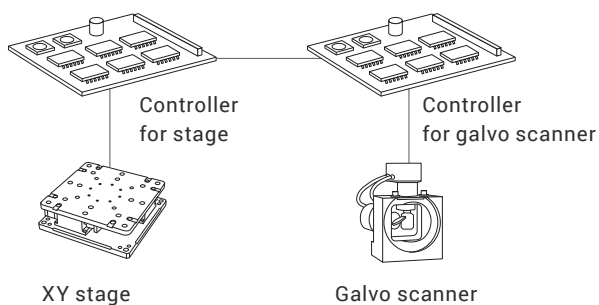

CK3M/CK5M

A single controller provides high-precision synchronous control. Also a wide variety of actuators can be controlled, increasing machine performance.

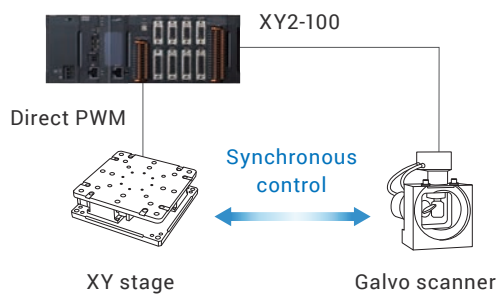

A variety of control modes to optimize system configuration

In addition to hardware, software also supports multiple motor control modes including position, velocity, torque, sinewave, and Direct PWM modes. A control mode that best suits your application delivers high-speed, high-precision control.

⋯ Motion PLCs cannot control some actuators because they have fewer command modes.

⋯ The CK3M/CK5M Series that has all command modes can control actuators suitable for the application.

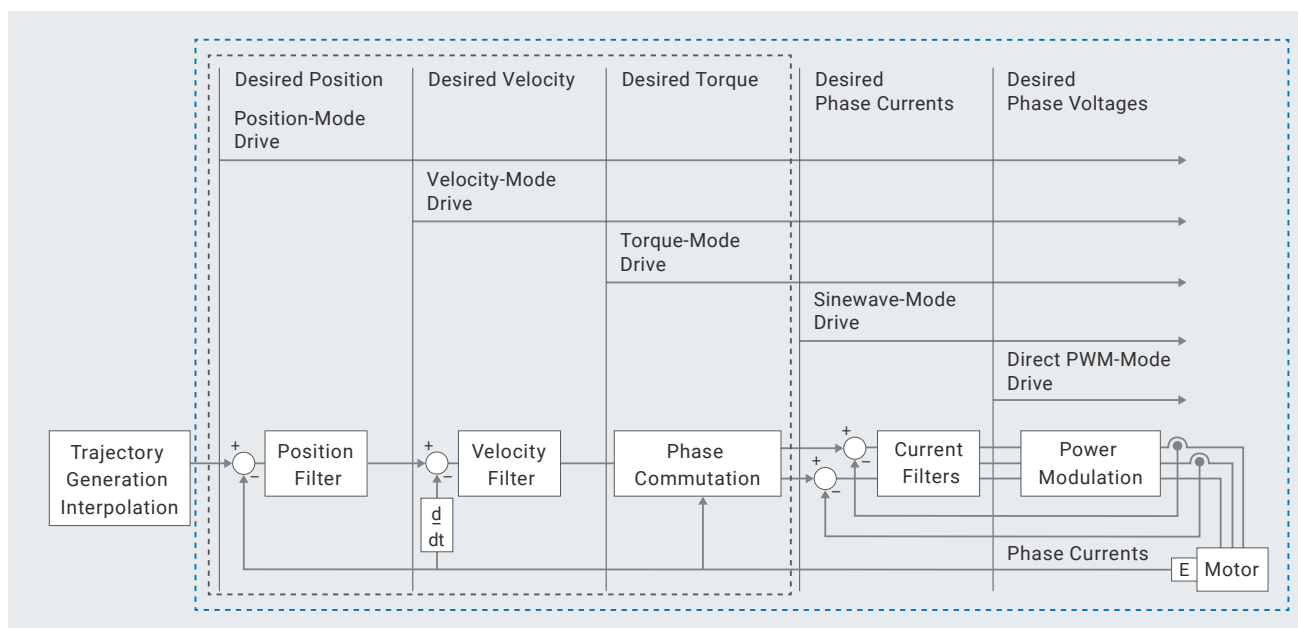

Capable Flexible development of various applications

The flexible PMAC architecture and software structure help you realize your difficult applications by easily incorporating your own algorithms.

A range of programming languages for various applications

The original programming language allows you to create complex and advanced algorithms. The CK3M/CK5M Series can also be programmed in C language which facilitates the implementation of functions, such as very complex algorithm and log file processing in the controller, which are difficult with standard controllers. In addition to customization of standard G-Code functions by defining subroutines, your own G-Code functions can be incorporated.

Standard controller

A standard controller can be programmed only using its original programming language, and it is difficult to implement unsupported functions.

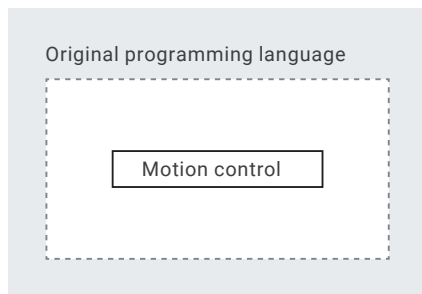

CK3M/CK5M

Supporting C language and G-Code functions as well as its original programming language, the CK3M/CK5M Series can be used for a variety of applications.

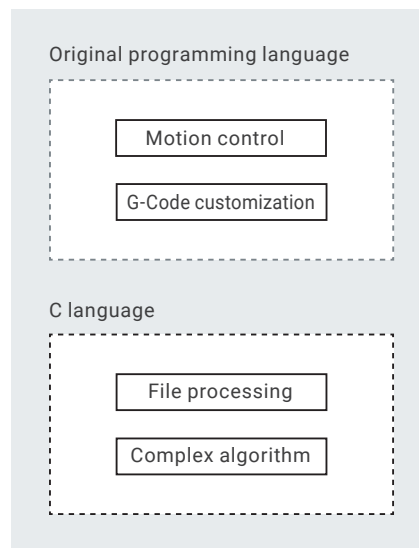

Open software structure for various applications

Applications that require complex actuator mechanisms (e.g., robot and on-the-fly laser processing) can be easily created by customizing the relationship between processing data and actuator machine coordinate systems.

Standard controller

Customization is not allowed because internal processing is concealed. Only limited applications can be realized.

Uncustomizable internal processing

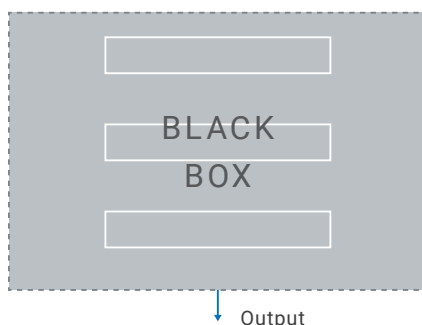

CK3M/CK5M

Internal processing can be customized to realize various applications.

Customizable internal processing

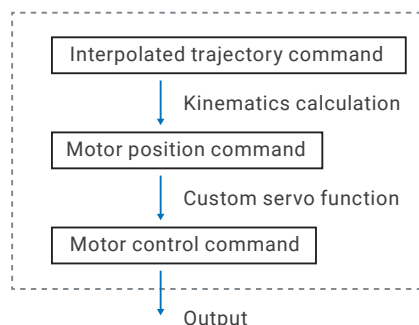

Easy Integrated system to reduce machine design time

EtherCAT®, EtherNet/IP™, OPC UA server and MQTT connectivity enables a single controller to control devices including peripherals and a single tool to integrate programming and configuration, shortening the time required for designing machines.

Quick design without the need for interlocking

A single controller with EtherCAT and EtherNet/IP connectivity controls not only processing actuators but also transfer axes and peripheral devices. This means that interlocking is no longer required, reducing machine design time.

Standard controller

It takes time and effort to interlock with a PLC that controls transfer axes and peripherals.

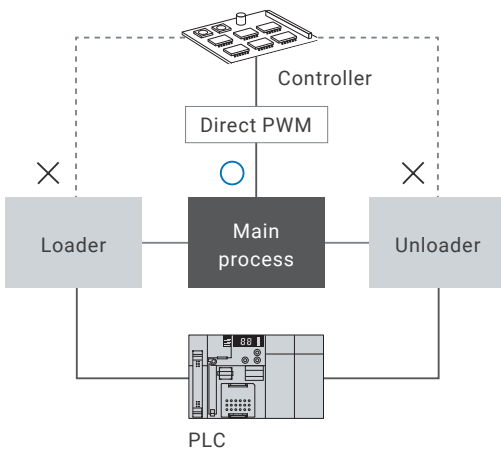

CK3M/CK5M

The CK3M/CK5M Series controls all including transfer axes and peripherals, eliminating the need for interlocking.

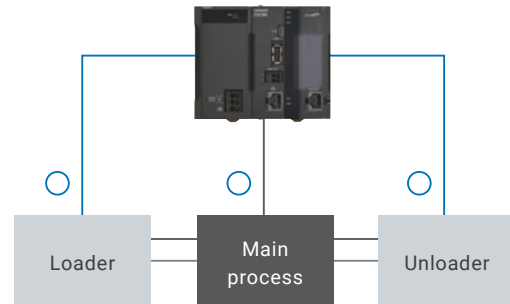

Easy setup with integrated software

The Power PMAC IDE is a development environment that integrates programming and communications setup, further reducing design time.

Typical software

In addition to management software for host communications, different controllers require different programming software. Programming and setup require considerable time and effort.

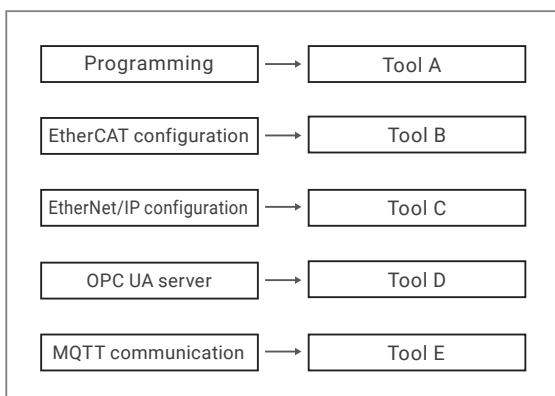

CK3M/CK5M

The Power PMAC IDE can be used for programming and setup, saving time and effort.

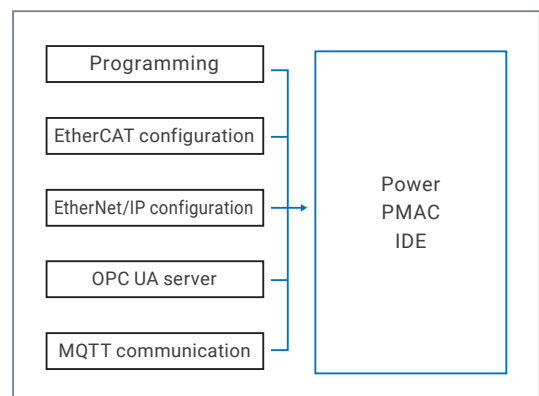

Note: The OPC UA server and MQTT communication functions are supported with firmware revision 2.8.1 or later.

Applications leveraging features

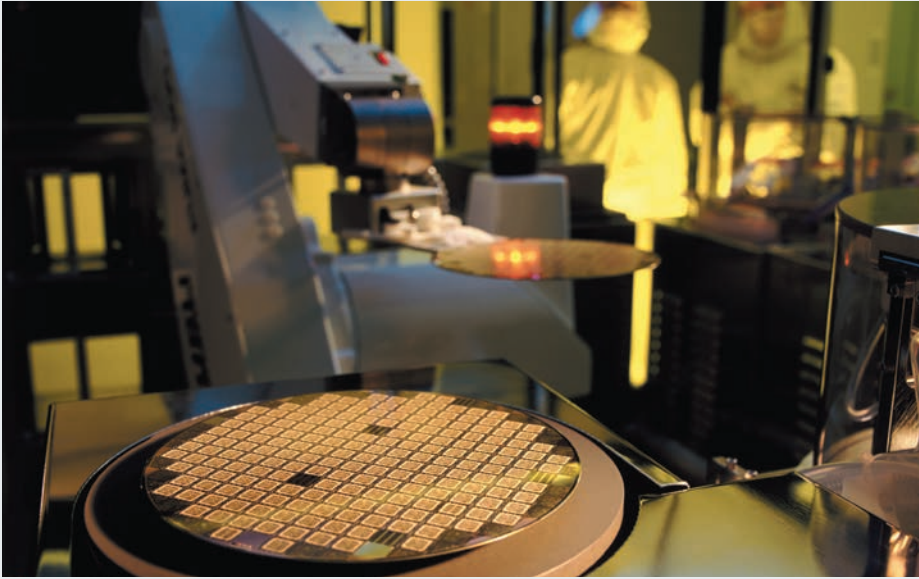

Semiconductor and FPD manufacturing and inspection machines

Extremely precise motion for exposure machines, coaters, dispensers, and wafer inspection machines.

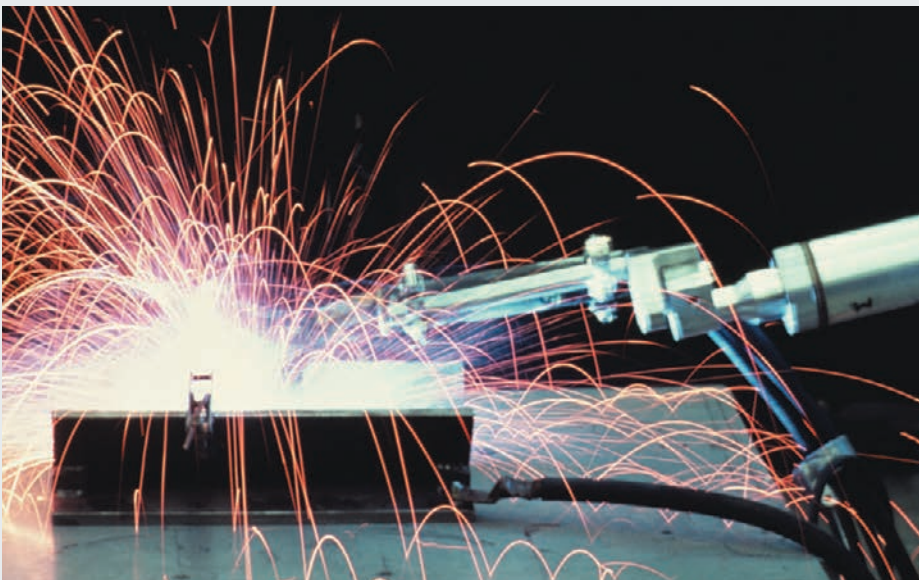

Complex shape machining and robots

Complex mechanical control for machines using customized robots.

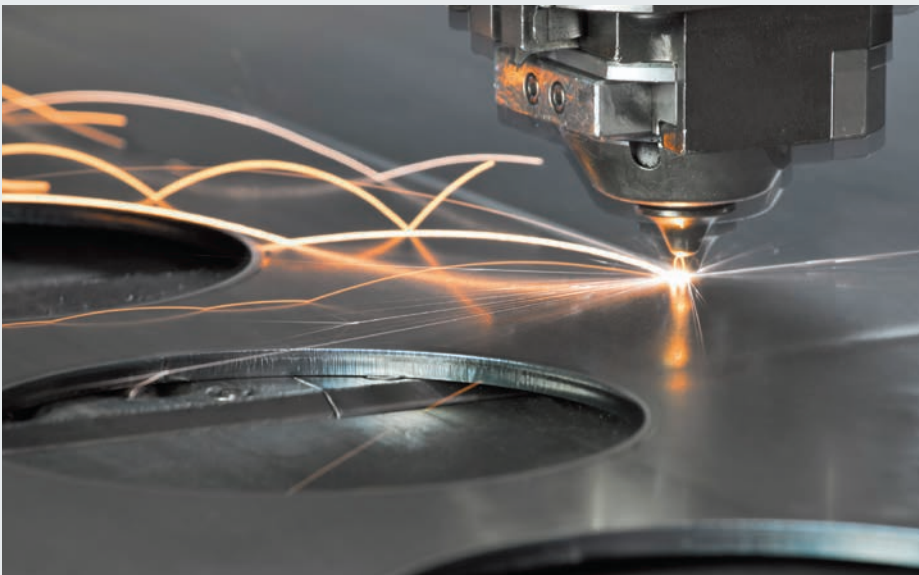

Processing machines and pressing machines

High-speed, high-precision processing for electric discharge machines, water jet machines, laser processing machines, grinders, and precision pressing machines.

Semiconductor and FPD manufacturing: Increase processing speed and precision to boost throughput

The process to cut large substrates into the desired sizes is vital to the production of FPDs that are the main component of display devices. Precision laser cutting is widely used in this process.

The growing demand for electrical appliances is increasing the need for display devices. One of the simplest ways for manufacturers to improve throughput is to increase laser scanning speed. If the speed is increased, however, command calculation precision and available actuator mechanisms will be limited, resulting in failure to increase both precision and speed.

Increase throughput by synchronizing processing between up to 16 heads

The CK3M/CK5M Series enables multi-head processing using multiple galvo actuators for one workpiece. Since up to 16 galvo scanners can simultaneously scan each area, overall throughput of the machine can be improved without increasing the scanning speed.

Simple processing

When only speed is adjusted to shorten processing time, precision is reduced.

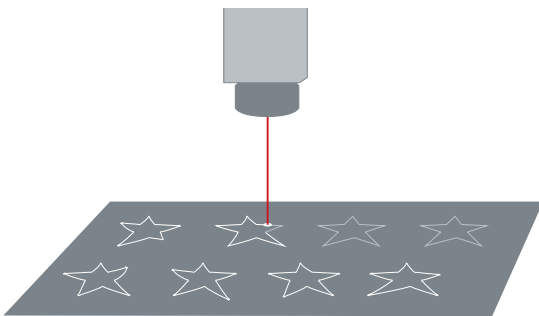

Multi-head processing

Processing using synchronized multiple heads eliminates the trade-off between processing speed and precision, increasing throughput.

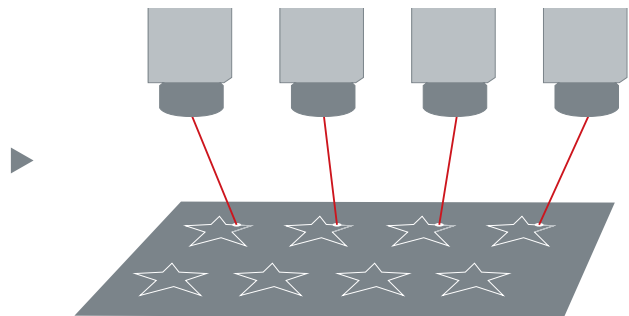

Increase processing precision through high-speed calculation and synchronized commands

Sophisticated synchronization between galvo actuators is crucial to the above application. The CK3M/CK5M Series can precisely calculate trajectory interpolation commands with a fastest servo cycle time of 25 μs.

The laser interface unit can precisely synchronize command outputs between up to 16 heads, further improving processing precision.

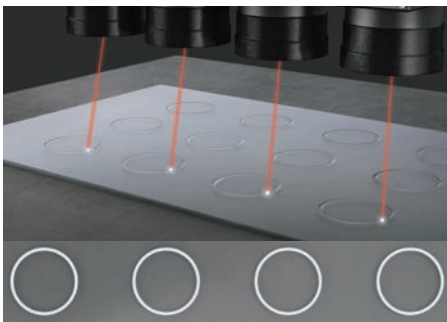

Both commands and laser ON/OFF timings are synchronized to process products of the same shape.

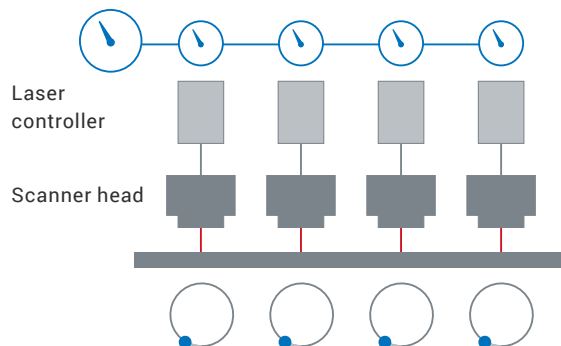

Smart device manufacturing: Perform difficult and complex shape machining

Smartphones and smart devices are dramatically changing our life. Furthermore, there is a rapidly growing demand for wearable smart devices such as AR and VR devices. Since wearable smart devices, unlike conventional smartphones, are designed to be worn on a body, the shapes are three-dimensional and complex. Therefore, it is extremely difficult to produce three-dimensional shaped wearable smart devices using conventional machines for XY two-dimensional machining.

Flexible software structure for three-dimensional complex machining

Complex actuator mechanisms are typically used for three-dimensional machining, and the difficulty is to calculate commands to actuators from coordinate data for machining. The CK3M/CK5M Series supports C and original programming languages, allowing you to create complex and advanced algorithms. You can also implement algorithms to calculate commands to virtually any actuator by customizing the relationship between machining data and actuator machine coordinate systems.

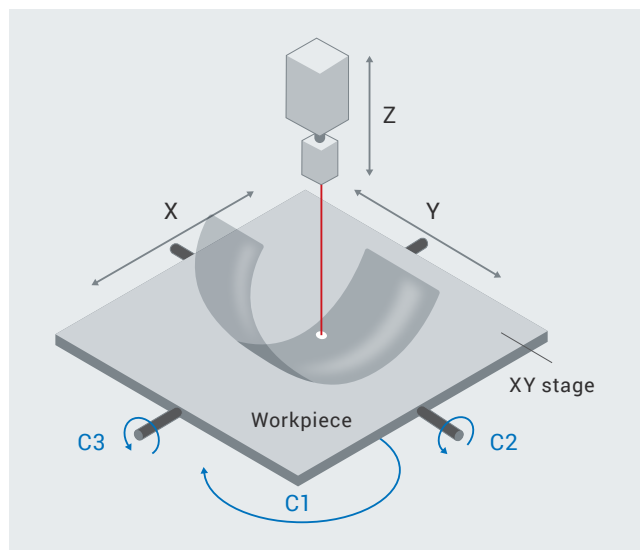
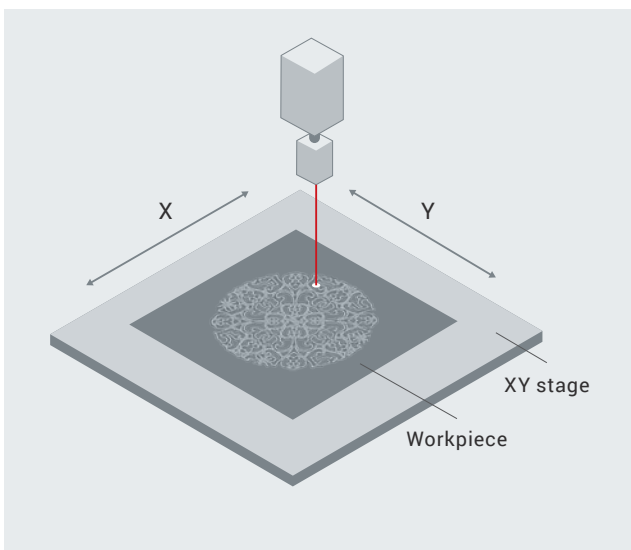

Multi-vendor compatibility to optimize system configuration for complex machining

Complex actuator mechanisms used for three-dimensional machining generally consist of several types of actuators (e.g., linear motor, rotary motor, and voice coil motor) depending on operating patterns. It is ideal that a single controller connects to various actuators.

The CK3M/CK5M Series with many interfaces including analog commands, Direct PWM, and EtherCAT allows users to choose actuators best-suited for their applications and pursue machining precision.

Standard controller

Since the controller can connect only to actuators from the same vendor, it is impossible to configure optimal systems providing ideal machining precision.

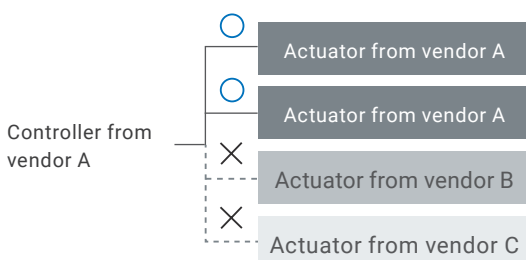

CK3M/CK5M

The CK3M/CK5M Series can connect to actuators from any vendor, allowing you to optimize system configurations for ideal machining precision.

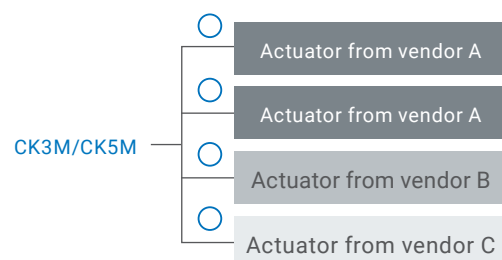

Processing machines: Improve quality with IoT systems

As awareness of environmental issues has grown in recent years, the ratio of output to material input has become increasingly significant. There is a growing number of machines using IoT systems, which collect real-time machining data with controllers and analyze it with host systems, in order to increase machine yield. However, the introduction of IoT systems into conventional control systems can cause problems such as failure to capture necessary data for improvement within a control period and adverse effects on control during communications.

Improve quality by obtaining all abnormal data in fast sampling cycles

Long sampling period can result in missing necessary points for improvement because abnormal data that appears instantly during machining cannot be acquired. Since problems cannot be found through data analysis, quality improvement will not be achieved. The CK3M/CK5M Series can obtain even instantaneous abnormal data in a fast sampling cycle, helping improve machining quality through data analysis.

Standard controller

Quality cannot be improved through data analysis because important data cannot be obtained.

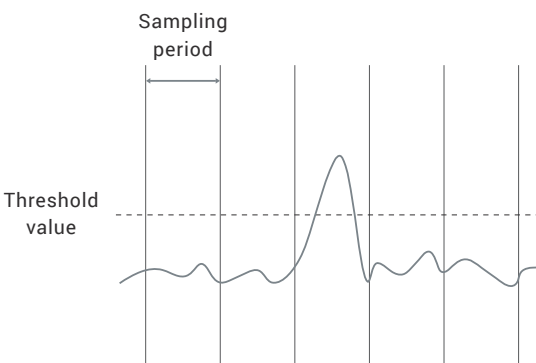

CK3M/CK5M

Quality can be improved through data analysis because all abnormal data can be obtained.

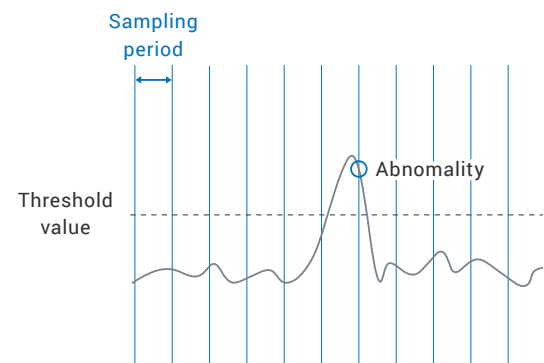

Reduce time required to evaluate IoT systems with multi-core CPU

A conventional system uses the same CPU core for control and communications with the host system. Every time the IoT system is adjusted, effects on the control system must be evaluated. This increases overall evaluation time. The CK5M Series with a multi-core CPU performs control and communications separately. The introduction of an IoT system does not affect the control system, reducing evaluation time.

Standard controller

The introduction of an IoT system will affect the control system because the same core performs control and communications tasks.

Dual CPU

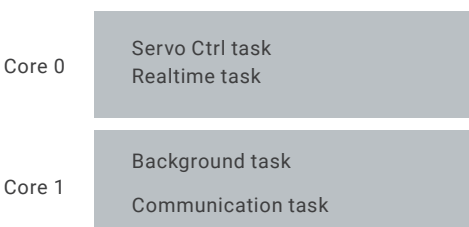

CK5M

The introduction of an IoT system hardly affects the control system because different cores perform different tasks.

QUAD CPU

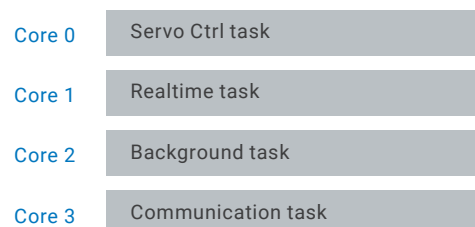

Power PMAC IDE Integrated development environment (IDE)

The Power PMAC IDE is an integrated development environment based on Microsoft® Visual Studio® that development engineers use as a development platform around the world. This IDE integrates motion programming for PMAC, motor setup and tuning, debugging, and troubleshooting. Lightweight, sophisticated GUI provides intuitive user operations, which helps you improve application development productivity.

Microsoft® Visual Studio® based integrated development environment

Hardware setup, programming, code debugging, and EtherCAT and EtherNet/IP configuration can be accessed from one screen.

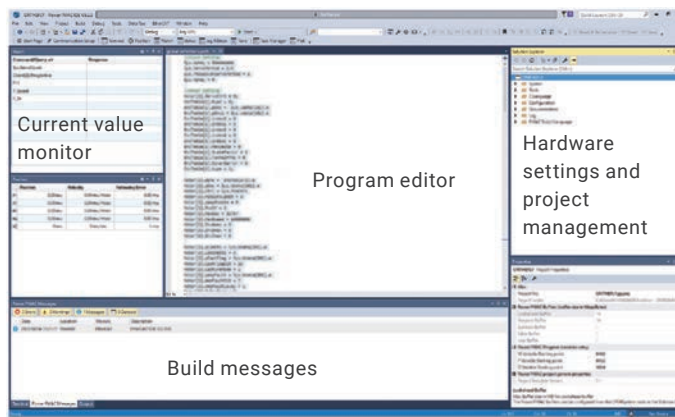

Easy tuning

Autotuning allows easy tuning of motors and intuitive fine-tuning.

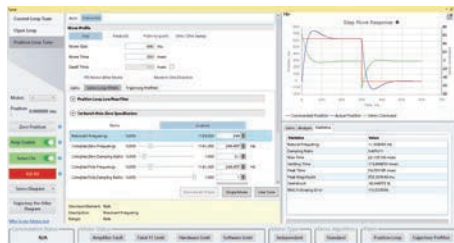

Simple setting

Just follow the workflow to set up motors.

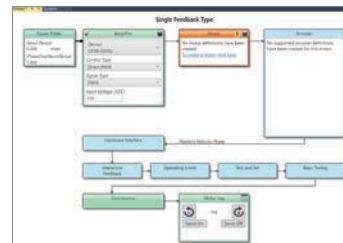

Troubleshooting and verification

You can monitor various data in real time on the watch table and status window. The plot tool visualizes data collection.

Command/Query	Response
Sys.Time	[F] 15,753.364
MyVar1	[F] 1.234560
Motor[3].PhasePos	[I] 4
Coord[1].ProgActive	0
Input1.8	00000000
Motor[1].JogSpeed	C
Iqff	
Iqint	
IqMeas	

Network configuration

The network configuration tool supports EtherCAT and EtherNet/IP. Network devices can be easily connected, and status can be monitored.

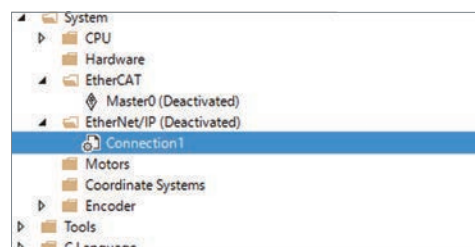

IP Protection

IP Protection allows engineers to protect their intellectual property by encrypting script programs. An engineer can encrypt the script programs per file and pass the project on to another engineer. The engineer who takes the project can add their own logic but cannot list or view the code encrypted by another engineer. The encryption is three-level password protected: OEM builders, independent integrators, and users can share a project securely and flexibly.

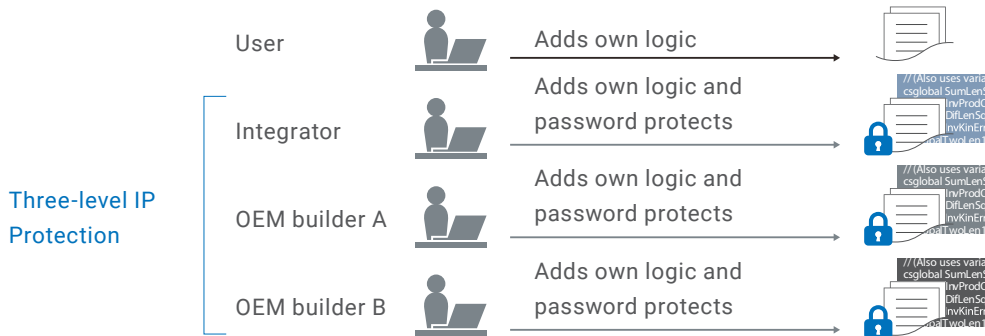

System configuration

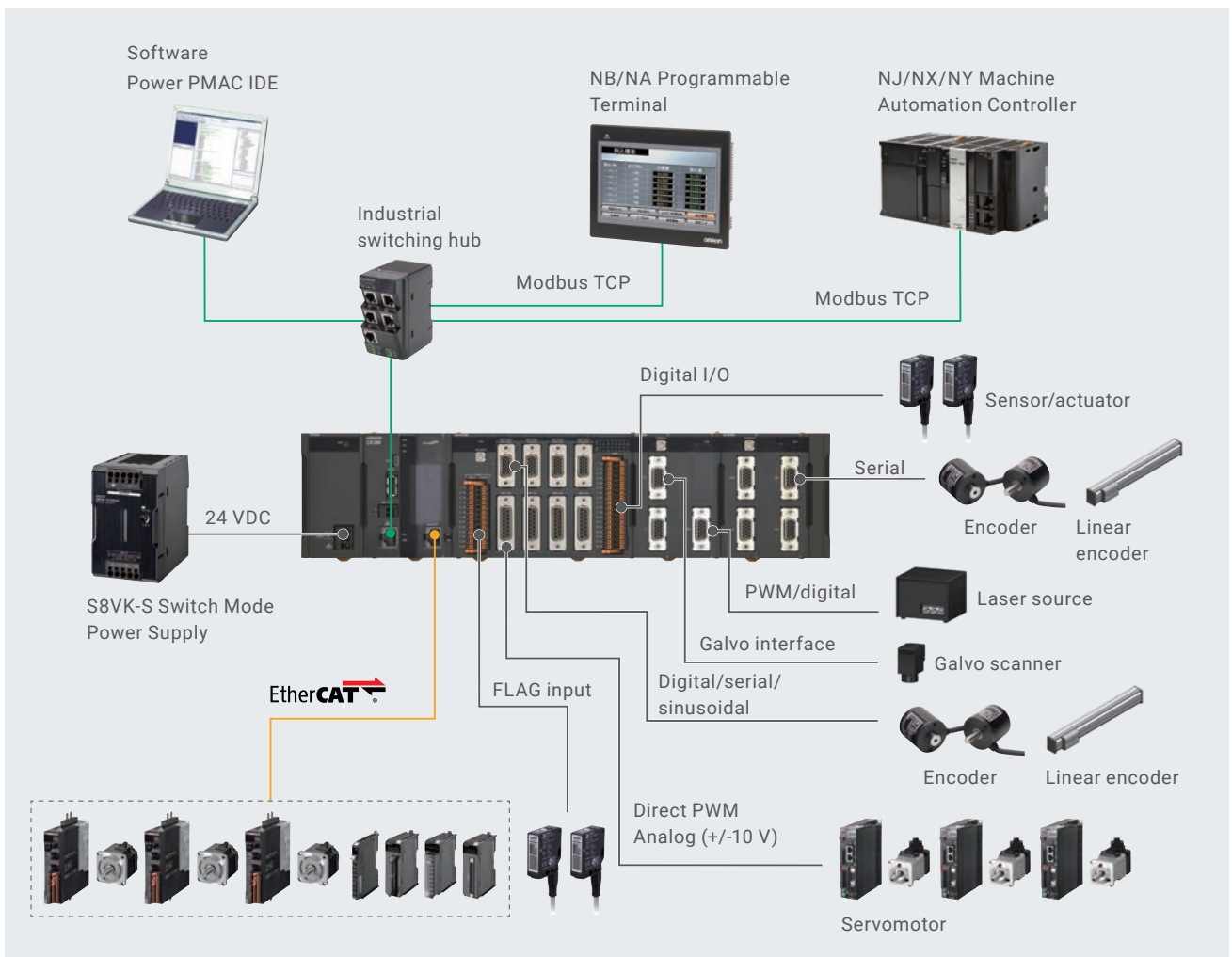

Specifications

Product name		CK3M	CK5M
Motion control	Max. no. of controlled axes	24 (4 axes/axial interface unit x 4 units: 16, EtherCAT: 8)	64 (4 axes/axial interface unit x 8 units: 32, EtherCAT: 32)
	Motion control period	CK3W-AX Unit: 50 μs/5 axes or more EtherCAT: 250 μs min. (depending on communications cycle)	CK3W-AX Unit: 25 μs/5 axes or more EtherCAT: 62.5 μs min. (depending on communications cycle)
	Control method	Analog (Filtered PWM, True DAC), pulse, Direct PWM	
Interface		Ethernet port (EtherNet/IP, OPC UA*1, MQTT*1), EtherCAT port (CPU option)	Ethernet port (EtherNet/IP, OPC UA*1, MQTT*1), EtherCAT port
Feedback		AB phase, serial encoders, sinusoidal encoder	
Memory	RAM	1 GB	2 GB
	Flash	2 GB*2	4 GB
Number of connectable CK3W Units	CPU rack	Up to 4 CK3W Units (or up to 2 CK3W-AX Units)	
	Expansion rack	Up to 4 CK3W Units (or up to 2 CK3W-AX Units)	Up to 12 CK3W Units (or up to 6 CK3W-AX Units)

*1.The OPC UA server and MQTT communication functions are supported with firmware revision 2.8.1 or later.

*2.The flash memory of the CPU unit firmware revision 2.7 or earlier is 1 GB.

PMAC Series family

CPU Units

Product name	Memory capacity	EtherCAT port	Max. no. of controlled axes via EtherCAT port	Expansion	Model
CK3M CPU unit*1	RAM: 1 GB Built-in flash memory: 2 GB*2 CPU: Dual core 1 GHz	None	—	One expansion rack can be connected using the expansion master unit and expansion slave unit	CK3M-CPU101
		EtherCAT: 1 port (DC sync)	4		CK3M-CPU111
			8		CK3M-CPU121
CK5M CPU unit*1	RAM: 2 GB Built-in flash memory: 4 GB CPU: Quad core 1.6 GHz	EtherCAT: 1 port (DC sync)	16	Three expansion racks can be connected using the expansion master unit and expansion slave units	CK5M-CPU131
			32		CK5M-CPU141

*1.One End Cover is provided with the CK□M-CPU1□1 CPU Unit. The CK3W-TER11 End Cover for the CK□M-CPU1□1 is sold separately if required.

*2.The flash memory of the CPU unit firmware revision 2.7 or earlier is 1 GB.

Axial Interface Units

Product name	Amplifier interface	Encoder interface	Output type	Model
Axial Interface Unit	Direct PWM output	Digital quadrature encoder/serial encoder	NPN type	CK3W-AX1313N
	DA output (Filtered PWM)			CK3W-AX1414N
	DA output (True DAC)			CK3W-AX1515N
	Direct PWM output	CK3W-AX2323N		
	Direct PWM output	Digital quadrature encoder/serial encoder	PNP type	CK3W-AX1313P
	DA output (Filtered PWM)			CK3W-AX1414P
	DA output (True DAC)			CK3W-AX1515P
	Direct PWM output			CK3W-AX2323P

PMAC Series products

CK3M/CK5M Series

Powerful and user-friendly flagship controller



CK3E

Compact EtherCAT-ready controller for small machines



Power Supply Units

Product name	Specifications	Model
Power Supply Unit for CK□M-CPU1□1	Rated output voltage: 5 or 24 VDC, maximum output: 23 W at 5 VDC, 55 W at 24 VDC	CK3W-PD048

Digital I/O Units

Product name	Number of inputs	Number of outputs	I/O type	Model
Digital I/O Unit	16	16	NPN	CK3W-MD7110
			PNP	CK3W-MD7120

Analog Input Units

Product name	Input range	Number of inputs	Model
Analog Input Unit	-10 to 10 V	4	CK3W-AD2100
		8	CK3W-AD3100

Encoder Input Units

Product name	Encoder type	Number of channels	Protocol	Model
Encoder Input Unit	Serial encoder	4	BiSS-C, Endat2.2, and encoder built into R88M-1L□/-1M□ Motor	CK3W-ECS300

Laser Interface Units

Product name	Communications method	Laser output	Model
Laser Interface Unit	XY2-100	PWM output	CK3W-GC1100
		PWM output, TCR output	CK3W-GC1200
	SL2-100	PWM output	CK3W-GC2100
		PWM output, TCR output	CK3W-GC2200

Expansion Master Units and Expansion Slave Units

Product name	Description	Model
Expansion Master Unit	Connect the Expansion Master Unit adjacent to the right side of the CPU unit.	CK3W-EXM01
Expansion Slave Unit*2	Connect the Expansion Slave Unit adjacent to the right side of the power supply unit.	CK5W-EXS01*3 CK3W-EXS02
Expansion Cable	Use the Expansion Cable (0.3 m) to connect between the Expansion Master Unit and the Expansion Slave Unit.	CK3W-CAX003A

*2. One CK3W-TER11 End Cover is provided with the Expansion Slave Unit.

*3. The CK5W-EXS01 Expansion Slave Unit can be used only with the CK5M CPU Unit, not with the CK3M CPU Unit.

- Microsoft® and Visual Studio® are either registered trademarks or trademarks of Microsoft Corporation in the United States and/or other countries.
- EtherCAT® is a registered trademark and patented technology, licensed by Beckhoff Automation GmbH, Germany.
- EtherNet/IP™ is a trademark of ODVA.
- Microsoft product screen shot(s) reprinted with permission from Microsoft Corporation.
- Other company names and product names in this document are the trademarks or registered trademarks of their respective companies.
- The product photographs and figures that are used in this catalog may vary somewhat from the actual products.
- Some images are used under license from Shutterstock.com.
- PMAC is an abbreviation for Programmable Multi Axis Controller.

Power UMAC Series

Modular system with excellent scalability



CK3A

Direct PWM amplifier for ultra-high-speed synchronous control



Before you place an order, please read and understand "Agreement for Using the Product" available on Omron's website.

Note: Do not use this document to operate the Unit.

OMRON Corporation Industrial Automation Company

Kyoto, JAPAN

Contact : www.ia.omron.com

Regional Headquarters

OMRON EUROPE B.V.

Wegalaan 67-69, 2132 JD Hoofddorp
The Netherlands
Tel: (31) 2356-81-300 Fax: (31) 2356-81-388

OMRON ELECTRONICS LLC

2895 Greenspoint Parkway, Suite 200
Hoffman Estates, IL 60169 U.S.A.
Tel: (1) 847-843-7900 Fax: (1) 847-843-7787

OMRON ASIA PACIFIC PTE. LTD.

438B Alexandra Road, #08-01/02 Alexandra
Technopark, Singapore 119968
Tel: (65) 6835-3011 Fax: (65) 6835-3011

OMRON (CHINA) CO., LTD.

Room 2211, Bank of China Tower,
200 Yin Cheng Zhong Road,
PuDong New Area, Shanghai, 200120, China
Tel: (86) 21-6023-0333 Fax: (86) 21-5037-2388

Authorized Distributor:

©OMRON Corporation 2018-2025 All Rights Reserved.
In the interest of product improvement,
specifications are subject to change without notice.

CSM_4_1

Cat. No. R196-E1-10 0425 (0318)