

Fiber Laser Marker  
MX-Z2000H-V1 series

OMRON

Fast, High Quality, Easy

# Marking Flexibility

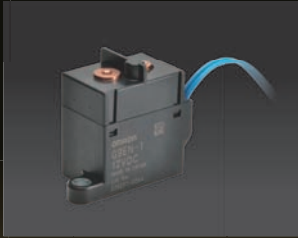
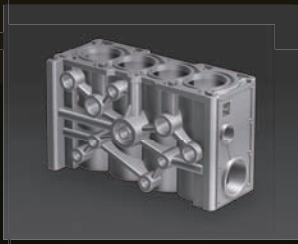

CE | FDA

UL<sup>®</sup>  
C US

Great for either deep or shallow engraving in metals, marking on plastics/resins or plastic films, and for fine processing.

**Mark anything** from electronic parts to automotive parts.



Deep engraving in metal



Shallow engraving in metal



Marking on plastics/resins

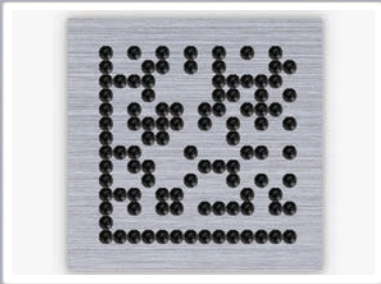

Deep engraving

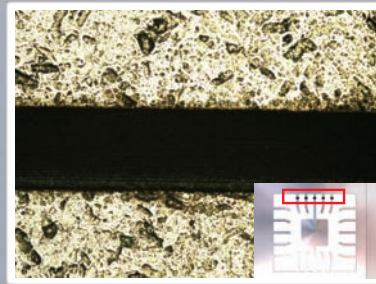

Fine processing

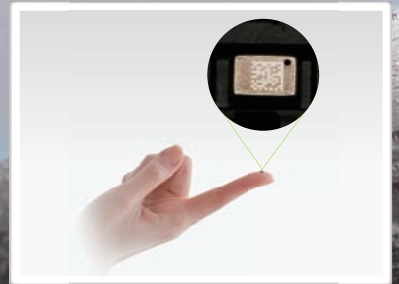

Fine marking

The MX-Z2000H Series Provides Benefits in Many Arenas

High Speed and High Quality for a Wide Variety of Applications

# Marking Flexibility

Metals

Plastics/  
Resins

Plastic  
Film

Two operating modes meet the application marking demands.

Enhanced 3D marking features.

G-DAC enables high-speed, clear marking.

» P4





Fiber Laser Marker

# MX-Z2000H Series

Enhanced functionality Improves Productivity

## Connectivity & Traceability

Direct finder link

Traceability log

EtherNet/IP™ ready

Data can be shared with external storage

➤➤ P6

Withstands Severe Ambient Conditions and Meets International Standards

## Durability/Safety

IP65 protection

Meets domestic and international safety standards

➤➤ P8

The OMRON Fiber Laser System ..... ➤➤ P9

Operation Flexibility ..... ➤➤ P10

High Speed and High Quality  
in a Wide Variety of Applications

# Marking Flexibility



## Two Operating Modes Provide Fine Detail to Deep Engraving

### Standard Mode

Our exclusive flexible pulse control (up to 1MHz, adjustable 1 - 20 pulses) enables optimum marking and processing for a variety of materials and applications, for a variety of materials and applications, including both heated and non-heated marking/processing, etc. For example, even for small character when thermal effects are problem, Fine marking is possible.

#### Laser Wave Examples

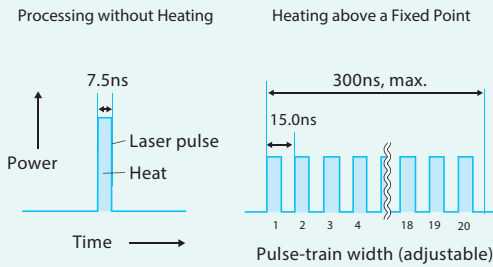

#### Color Marking (SUS304)



Solid material

Hairline processing

### Optional EE Mode (Energy Enhanced Mode)

Deep engraving of metal, rough polishing, and other energy-intense processing become possible with an expanded and enhanced flexible pulse control, which provides pulse streams of up to 30 pulses.

For example, deep engraving suitable for camera reading is possible even after heating process.

#### Omron Laser(EE Mode)

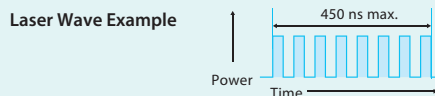

#### Process image

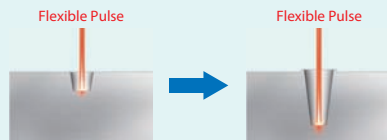

Flexible pulse laser increases output per pulse. Furthermore, by continuous irradiation, continuous irradiation transmits heat in the depth direction, enabling deep engraving.

#### Cross section image



#### Typical Laser



#### Process image

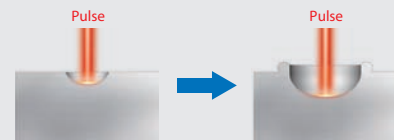

The output power per pulse of general laser is lower than that of flexible pulse laser. The heat mostly stays on the surface, resulting in a shallow engraving.

#### Cross section image



\* Because this mode is an option, you need to purchase the license "EE Mode Activation Key" to enable it.

# Marking 3D Objects Is Simple Even on Cones and Spheres

## High-precision Z-axis Flexibility

Clean marking is now possible for 3D surfaces, such as stepped, sloped, curved, conical and spherical surfaces without any additional software.



Cylinder



Steps

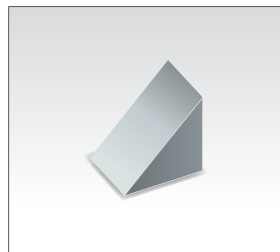

Slope



Sphere exterior



Truncated Cone



Truncated Cone interior



Half-cone interior

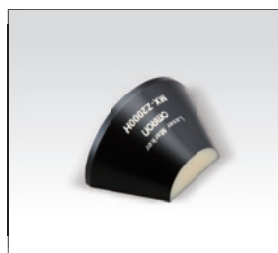

Half-cone exterior

The focus point can be moved  
 170±10mm for the MX-Z2000H,  
 and 220±10mm for  
 the MX-Z2050H/Z2055H.



# Mark Clearly and Cleanly Even at High Speed

## <G-DAC>

**G-DAC stands for the OMRON-developed Galvano Dynamic Acceleration Control.**

The G-DAC feature adjusts the laser marking speed for optimum performance, based on the marking details. This speed flexibility enables high-speed, clean marking.

### With/Without G-DAC

**Marking time with the same data**

Note: Marking conditions shown to the right.

Workpiece: Aluminium  
Letter height: 1mm

**Without G-DAC**

116ms

**With G-DAC**

54ms

Double the speed; about half the time

**Marking at the same speed**

Without G-DAC

With G-DAC

Improved performance

Note:  
Laser conditions: 100kHz, 100%; Workpiece: Aluminium

Note: G-DAC performance depends on the application. Be sure to test your application in advance.

Enhanced Functionality  
Improves Productivity

# Connectivity & Traceability



## Position-correction without the need of a PLC

### Direct Finder Link

The MX-Z2000H series enables direct connectivity between the image processing system and the laser marker that traditionally required PLC processing. This means, there is no need for a PLC to do the linking between the vision system and the laser marker.

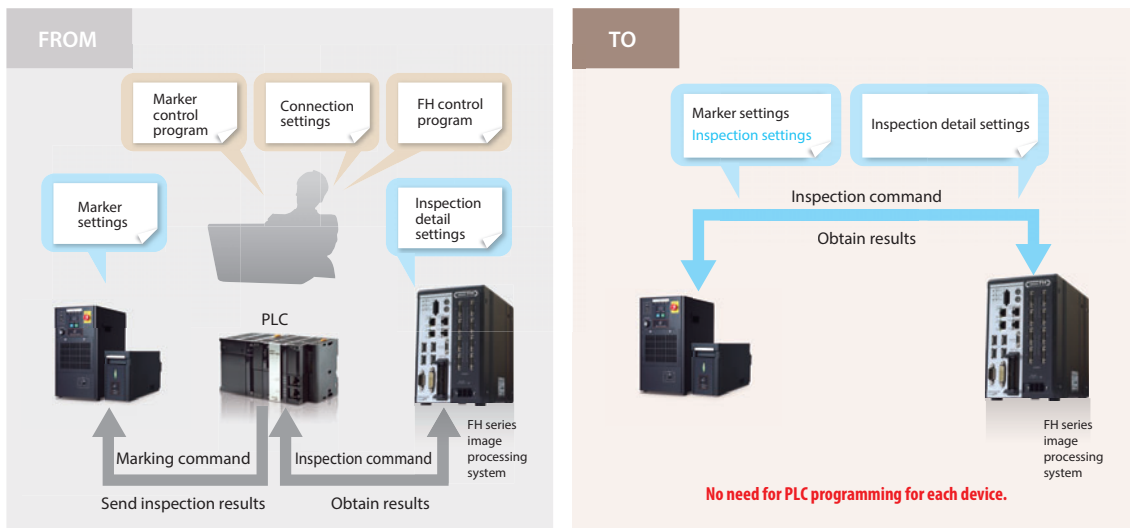

Notes: 1. The optional finder feature is required to use this function.  
2. As the end of April 2017, corresponding image processing system is OMRON FH series and part of FQ2 series.  
Please refer to finder option catalogue Q255-E1 to select image processing system.

**Example Application**

To mark a product in the same area everytime, an image processing system measures the position reference, transfers the position coordinates and the laser marker adjusts itself to mark in the correct place. After the laser marking is completed, the image processing system can also read a 2D code or any other inspection of the data or images just marked on the product.

MX-Z2000H series laser marker  
+  
Finder option  
+  
FH series image processing device

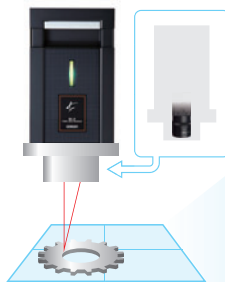

1. Use image processing to measure the position difference.

2. Compensate for position differences and mark correctly.

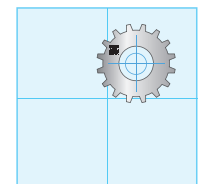
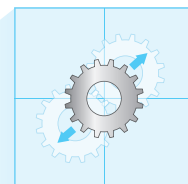

# Easily Configure a Traceability System

## Traceability Log

Archive marking data, and other data to a log, etc. Simplify both traceability and preventive maintenance.

### System Concept Example

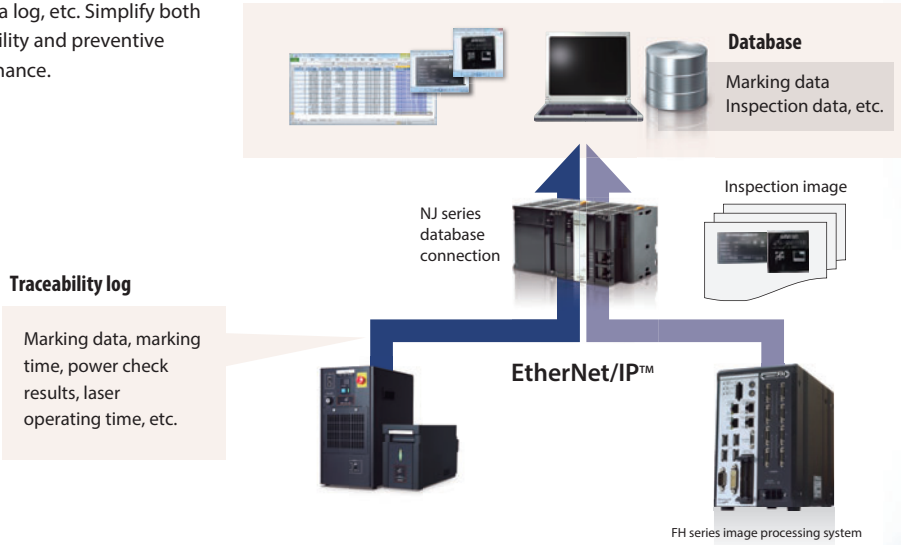

# Smoothly Integrate External Control

## EtherNet/IP™ Compatibility

The MX-Z2000H series is compatible with various kinds of external control. Built-in I/O connections, RS-232C, Ethernet, and EtherNet/IP™ simplify programming to control the system from a PLC.

\*Please check the user's manual before using available functions and commands.



# Marking for Small Lots with Multiple Variants

## Data can be shared with external storage

The MX-Z2000H series can access the marking data that is stored on an Ethernet server to keep up with the tremendous amount of data used for multi-variant, small lot productions. This simplifies the switching of marking data for each variant.

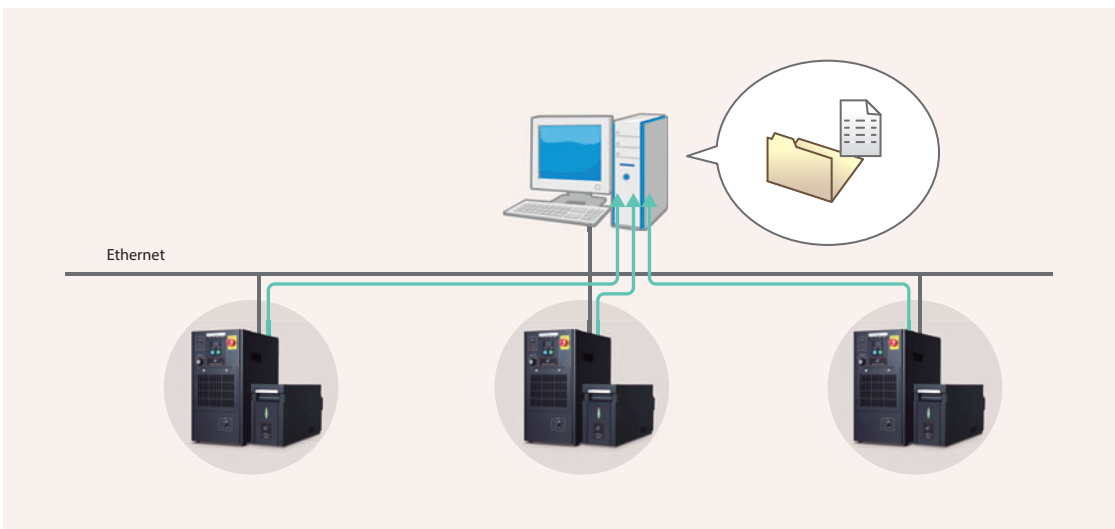

Withstands Severe Conditions  
and Meets International Standards

# Durability/Safety



## Stable Operation Even in Dusty/Wet Environments

### Durable IP65 Head

The laser head (where the laser light is emitted) has a double glass cover to keep dust and moisture away and ensure air-tightness.

IP65 means dust-proof and wash-down capable, compatible with IEC60529. It consists of the two numbers, 6 and 5.

**IP 6 5**

**Protection against water**  
5: Protection from water, up to water projected by a nozzle against the enclosure from any direction.

Protection against solid objects  
6: Complete protection from dust.

The double glass cover makes it easier and safer to change the glass.

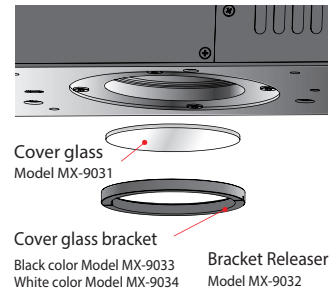
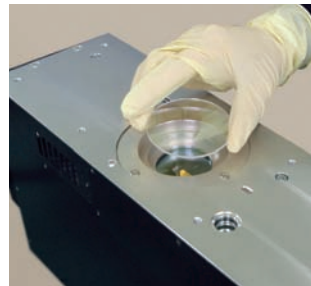

## Meets Safety Requirements and Standards

### NEW Built-in Safety Relay Circuit

When building a machine to meet the ISO 13849-1 (JIS-B9705-1) criteria, you have to provide safety measures for the total machine in which the laser marker is installed. The MX-Z2000H series has 2 safety relays in the controller, and sending an emergency stop signal from an external controller to the interlock terminals will absolutely stop the power supply to the laser. The safety relays installed on the back of the controller can be easily replaced in case of failure. The laser beam can be emitted within 1 second after returning from laser shutdown by Omron's original fiber laser system.

#### Interlock System Configuration Example

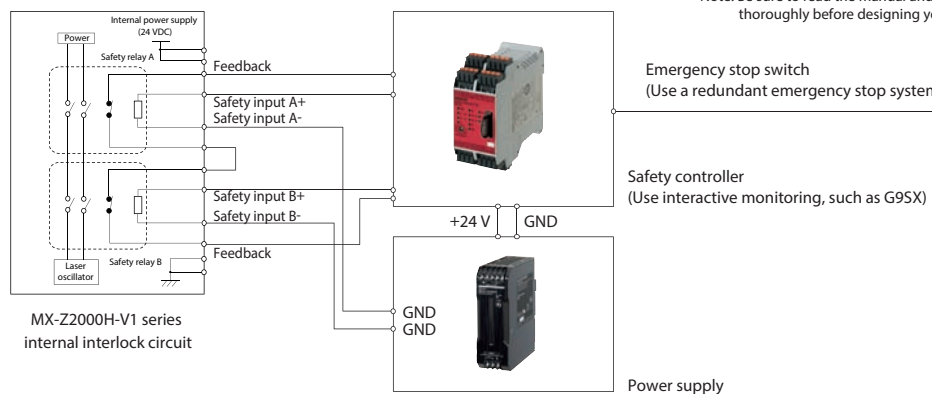

Note: Be sure to read the manual and other materials thoroughly before designing your system.

## Meets International Standards and Regulations

The laser markers meet each standard and regulation. They can now be used internationally.  
Note: For details about exact countries and areas, contact your local OMRON representative.



## OMRON's Fiber Lasers

# All-fiber Lasers Provide High Quality, High Stability, Long Life

### MOPA Fiber Laser

Typical solid-state lasers use mirrors to resonate and amplify the laser, and then Q-switching to output the laser. However, this approach makes it difficult to achieve a high quality and flexible laser. It also leaves something to be desired in the areas of reliability and durability. OMRON has achieved high quality, high stability, long life and flexibility by eliminating the resonator configuration and using the MOPA approach.

OMRON MOPA Fiber Laser	Typical Solid-state Laser	Typical Fiber Laser
<p>MOPA stands for Master Oscillator Power Amplifier.</p>		
<ul style="list-style-type: none"> <li>· Wide range of pulse repetition frequency settings.</li> <li>· High flexibility for setting the pulse width and shape.</li> <li>· High beam quality, high stability, long life.</li> </ul>	<ul style="list-style-type: none"> <li>· Pulse width depends on the repetition frequency.</li> <li>· The laser diode is always on, accelerating deterioration.</li> <li>· Issues with the durability of the Q switch, mirrors, etc.</li> </ul>	<ul style="list-style-type: none"> <li>· Difficult to achieve a high peak output.</li> <li>· Narrow range of pulse repetition frequency settings.</li> <li>· Pulse width depends on the frequency.</li> </ul>

#### High Beam Quality

The closer the beam is to a perfect circle, the higher the quality of the laser. OMRON lasers have a very round, high quality beam, as shown to the right.

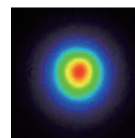

High beam quality

## Corrects for Lens Distortion

### High Position Resolution/Coordinate Correction

Precision positioning is now possible for fine detail, and processing area distortion is minimized. Coordinate correction is provided to eliminate errors based on installation.

High Position Resolution	Coordinate Correction
<p><b>Before correction</b></p> <p>Processing area distortion control</p> <p><b>After correction</b></p>	<p>Processing position before correction</p> <p>Processing result after correction</p>

#### Example Applications



Marking a scale



Marking on electronic parts in a tray

# Operation Flexibility Increases Throughput With Less Effort

## Edit the Marking Data Directly on the Laser Marker

### Editing Data

There is no need to buy separate editing software, or a computer to edit data. Data editing functionality is built right into the laser marker itself, simplifying the process.



### Editing Data Offline

Create and edit the marking data directly.

### Editing Fonts and Logos

Optimize fonts, logos (graphics), and pattern data directly.

### Offline Editing Software is Also Standard

You can also use a separate computer if you choose, to create and edit the print data, including graphics, with the same functionality as is built into the laser marker.

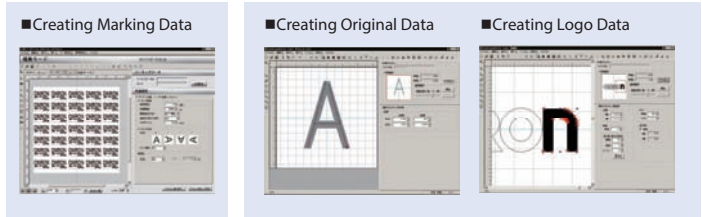

## Simplifying Positioning and Other Floor Work

### Optional Features

#### Finder (Vision Attachment)

The Finder feature enables visual positioning of small parts for marking or processing, as well as automated positioning and inspection with a vision system. This simplifies the system configuration, reducing processes, cycle time, and costs.

Please refer to the catalogue Q255-E1

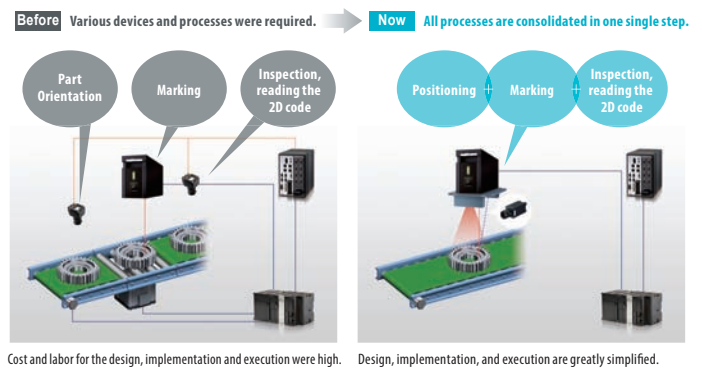

### Laser Marking Samples

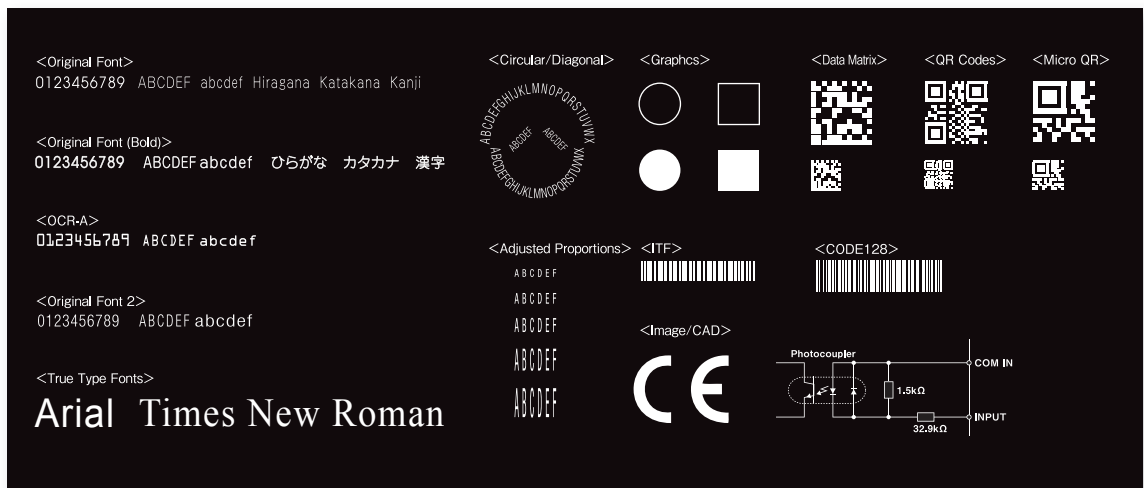

## Specifications

Item	MX-Z2000H-V1	MX-Z2050H-V1	MX-Z2055H-V1*1	
Processing laser	Type	Fiber laser Wavelength : 1,062nm		
	Laser class	Class 4 (IEC60825-1)		
	Average output	20W (Fiber laser transmitter output)		
	Laser output mode	Standard mode/EE mode*2		
	Repetition frequency	Standard mode 10kHz to 1,000kHz in 0.1-kHz steps/EE mode*2 10kHz to 100kHz in 0.1-kHz steps		
	Pulse-train width(pattern)/setting	Standard mode 7.5ns~300ns(15patterns)/EE mode*2 150ns~450ns (3patterns)		
Guide laser and focus pointer	Type	Semiconductor laser wavelength: 655nm		
	Laser class	Class 2 (IEC60825-1)		
Optical specifications	Marking area	90×90mm	160×160mm	160×160mm
	Working distance	170±10mm	220±10mm	220±10mm
Scanning specifications	Scan speed	1~12,000mm/s		
	Marking resolution	2µm	4µm	4µm
Detail of marking	Text	original / original2 / OCR-A / OCR-B / SEMI / LM font / True Type font		
	Bar code	CODE39 / NW-7 / ITF / CODE128 / JAN		
	2D code	GS1 Databar Omni-directional / GS1 Databar Truncated/GS1 Databar Limited / GS1 Databar Expanded		
	shape	Fixed point / Straight line / Rectangle / Circle / Arc		
	3D shapes	Slope / Step / Cylinder / Truncated Cone / Sphere		
	Image and CAD	BMP/JPG/PNG/DXF		
Settings	No. of data/blocks	Marking data :10,000. ; blocks :2,048		
	Text setting	0.1mm~120mm		
Cables	Fiber cable	4.5m Minimum bending radius: 100mm		
	Marker head control cable Marker head power supply cable	5m Minimum bending radius: 100mm		
External interface*3	Terminal block and I/O connector	Terminal block input 20pins(NPN/PNP compatible); terminal block 14pins(NPN/PNP compatible) I/O connector 37pins(NPN/PNP compatible),interlock terminal : input/output 8pins		
	Serial communications	RS-232C/RS-422A		
	Ethernet communication	Ethernet(1000BASE-T/100BASE-TX/10BASE-T) / EtherNet/IP™		
Power supply voltage	100 to 120VAC,50/60Hz ; 200 to 240VAC,50/60Hz			
Over voltage category	CAT II			
Power consumption	at 100VAC: maxmum 390VA , at 200VAC : maxmum 420VA			
Ambient conditions	Operating ambient temperature*4,humidity	0 to 40°C, 35 to 85%RH(no condensation)		
	Strage ambient temperature,humidity	-10 to 60°C(no freezing) / 35 to 85%RH(no condensation)		
	Installation environment	Indoor , 3,000m, max		
Pollution degree	2			
Protection structure(head)*5	IP65			
Coolin method	Forced air cooling			
Weight	Marker head Approx.15kg, Controller Approx.25kg			
Size	Marker head W140×H230×D415mm(excluding projections), Controller W225×H430×D390mm(excluding projections)			
Installation direction	Marker head All directions of up, down, left and right (intake vent on the left side face must not be blocked.)Controller Must be installed vertically.			
USB interface*6	USB memory : Controller front panel, Type A connector, keyboard/mouse :controller back panel ,TypeA connector			
Accessories	Marker head control cable, Marker head power supply cable, System key , Removable terminals(input and output, 1each), Instruction sheet, CD-ROM(Office editing software*7, User's manual, Setup manual., Translation table between Japanese ,Chinese and Korean). Interlock release connector, Terminal opener, Cable tie, Warring labels.			

### Notes

- \*1 Faster marking for resins and plastics films (1.8x faster than MX-Z2050H, 2.0x faster than MX-Z2000H. In case of the fill marking on a plastic film )
- \*2 EE mode : Energy Enhanced mode (optional)
- \*3 There are restrictions on functions and commands that can be used by each external interface. Please check the user's manual before use.
- \*4 The operating temperature may be limited due to the processing conditions. When using ther laser continuously or close to continuously for laser processing,etc. ,please contact OMRON in advance.
- \*5 The head of this product is constructed for environmental protection under the conditions specified in IEC 60529(IJS C0920) , and is not guaranteed under any other conditions.
- \*6 Do not use the USB interfaces for anything other than ther specified applications.
- \*7 The following environment is required for using the offline editing software and font logo editor  
: Computer with a USB 2.0. or 1.1 port , Microsoft Windows\*7 / Windows\*8 / 8.1 / Windows\*10, Available hard disk space : 1GB, min. Display resolution : 1,024×768, min.

### <Items Sold Separately>

MX-9301	Controller power supply cable (PSE,UL) plug type B
MX-9302	Controller power supply cable (VDE,AS) plug type F
MX-9230	EE mode activation key
Finder option	Please refer to the catalogue Q255-E1.
Other	Contact your local OMRON representative about details.

Note: Use commercially available products for the other devices required: USB keyboard, USB mouse< and monitor (VGA 3-row 15-pin, or DVI-D input with 1,024×768 minimum resolution).

## External dimensions

Marker head (Unit: mm)

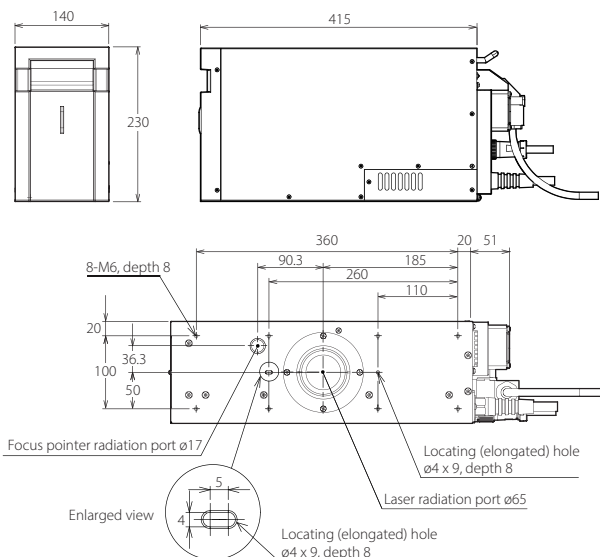

Controller

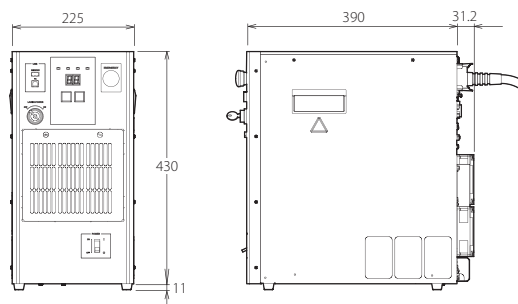

# Terms and Conditions Agreement

## Read and understand this catalog.

Please read and understand this catalog before purchasing the products. Please consult your OMRON representative if you have any questions or comments.

## Warranties.

- (a) Exclusive Warranty. Omron's exclusive warranty is that the Products will be free from defects in materials and workmanship for a period of twelve months from the date of sale by Omron (or such other period expressed in writing by Omron). Omron disclaims all other warranties, express or implied.
- (b) Limitations. OMRON MAKES NO WARRANTY OR REPRESENTATION, EXPRESS OR IMPLIED, ABOUT NON-INFRINGEMENT, MERCHANTABILITY OR FITNESS FOR A PARTICULAR PURPOSE OF THE PRODUCTS. BUYER ACKNOWLEDGES THAT IT ALONE HAS DETERMINED THAT THE PRODUCTS WILL SUITABLY MEET THE REQUIREMENTS OF THEIR INTENDED USE.

Omron further disclaims all warranties and responsibility of any type for claims or expenses based on infringement by the Products or otherwise of any intellectual property right. (c) Buyer Remedy. Omron's sole obligation hereunder shall be, at Omron's election, to (i) replace (in the form originally shipped with Buyer responsible for labor charges for removal or replacement thereof) the non-complying Product, (ii) repair the non-complying Product, or (iii) repay or credit Buyer an amount equal to the purchase price of the non-complying Product; provided that in no event shall Omron be responsible for warranty, repair, indemnity or any other claims or expenses regarding the Products unless Omron's analysis confirms that the Products were properly handled, stored, installed and maintained and not subject to contamination, abuse, misuse or inappropriate modification. Return of any Products by Buyer must be approved in writing by Omron before shipment. Omron Companies shall not be liable for the suitability or unsuitability or the results from the use of Products in combination with any electrical or electronic components, circuits, system assemblies or any other materials or substances or environments. Any advice, recommendations or information given orally or in writing, are not to be construed as an amendment or addition to the above warranty.

See <http://www.omron.com/global/> or contact your Omron representative for published information.

## Limitation on Liability: Etc.

OMRON COMPANIES SHALL NOT BE LIABLE FOR SPECIAL, INDIRECT, INCIDENTAL, OR CONSEQUENTIAL DAMAGES, LOSS OF PROFITS OR PRODUCTION OR COMMERCIAL LOSS IN ANY WAY CONNECTED WITH THE PRODUCTS, WHETHER SUCH CLAIM IS BASED IN CONTRACT, WARRANTY, NEGLIGENCE OR STRICT LIABILITY.

Further, in no event shall liability of Omron Companies exceed the individual price of the Product on which liability is asserted.

## Suitability of Use.

Omron Companies shall not be responsible for conformity with any standards, codes or regulations which apply to the combination of the Product in the Buyer's application or use of the Product. At Buyer's request, Omron will provide applicable third party certification documents identifying ratings and limitations of use which apply to the Product. This information by itself is not sufficient for a complete determination of the suitability of the Product in combination with the end product, machine, system, or other application or use. Buyer shall be solely responsible for determining appropriateness of the particular Product with respect to Buyer's application, product or system. Buyer shall take application responsibility in all cases.

NEVER USE THE PRODUCT FOR AN APPLICATION INVOLVING SERIOUS RISK TO LIFE OR PROPERTY OR IN LARGE QUANTITIES WITHOUT ENSURING THAT THE SYSTEM AS A WHOLE HAS BEEN DESIGNED TO ADDRESS THE RISKS, AND THAT THE OMRON PRODUCT(S) IS PROPERLY RATED AND INSTALLED FOR THE INTENDED USE WITHIN THE OVERALL EQUIPMENT OR SYSTEM.

## Programmable Products.

Omron Companies shall not be responsible for the user's programming of a programmable Product, or any consequence thereof.

## Performance Data.

Data presented in Omron Company websites, catalogs and other materials is provided as a guide for the user in determining suitability and does not constitute a warranty. It may represent the result of Omron's test conditions, and the user must correlate it to actual application requirements. Actual performance is subject to the Omron's Warranty and Limitations of Liability.

## Change in Specifications.

Product specifications and accessories may be changed at any time based on improvements and other reasons. It is our practice to change part numbers when published ratings or features are changed, or when significant construction changes are made. However, some specifications of the Product may be changed without any notice. When in doubt, special part numbers may be assigned to fix or establish key specifications for your application. Please consult with your Omron's representative at any time to confirm actual specifications of purchased Product.

## Errors and Omissions.

Information presented by Omron Companies has been checked and is believed to be accurate; however, no responsibility is assumed for clerical, typographical or proofreading errors or omissions.

Note : Do not use this document to operate the Unit

- EtherNet/IP is a trademark of ODVA.
- Microsoft and Windows are registered trademarks or trademarks of Microsoft Corporation in the USA and other countries.
- QR Code is registered trademark of DENSO WAVE INCORPORATED in Japan in other countries.
- Other company and product names mentioned in this document are trademarks or registered trademarks of their respective companies.



Note: Do not use this document to operate the Unit.

**OMRON Corporation Industrial Automation Company**

Kyoto, JAPAN

Contact : [www.ia.omron.com](http://www.ia.omron.com)

### Regional Headquarters

#### OMRON EUROPE B.V.

Wegalaan 67-69, 2132 JD Hoofddorp  
The Netherlands  
Tel: (31) 2356-81-300 Fax: (31) 2356-81-388

#### OMRON ELECTRONICS LLC

2895 Greenspoint Parkway, Suite 200  
Hoffman Estates, IL 60169 U.S.A.  
Tel: (1) 847-843-7900 Fax: (1) 847-843-7787

#### OMRON ASIA PACIFIC PTE. LTD.

438B Alexandra Road, #08-01/02 Alexandra  
Technopark, Singapore 119968  
Tel: (65) 6835-3011 Fax: (65) 6835-3011

#### OMRON (CHINA) CO., LTD.

Room 2211, Bank of China Tower,  
200 Yin Cheng Zhong Road,  
PuDong New Area, Shanghai, 200120, China  
Tel: (86) 21-6023-0333 Fax: (86) 21-5037-2388

### Authorized Distributor:

©OMRON Corporation 2019-2023 All Rights Reserved.  
In the interest of product improvement,  
specifications are subject to change without notice.

**CSM\_3\_1**

Cat. No. Q269-E1-02 1223 (0919)