

OMRON

Smart Sensors ZX-T Series

High-precision Contact Type

This manual not printed



Smart Style!

Operation Manual

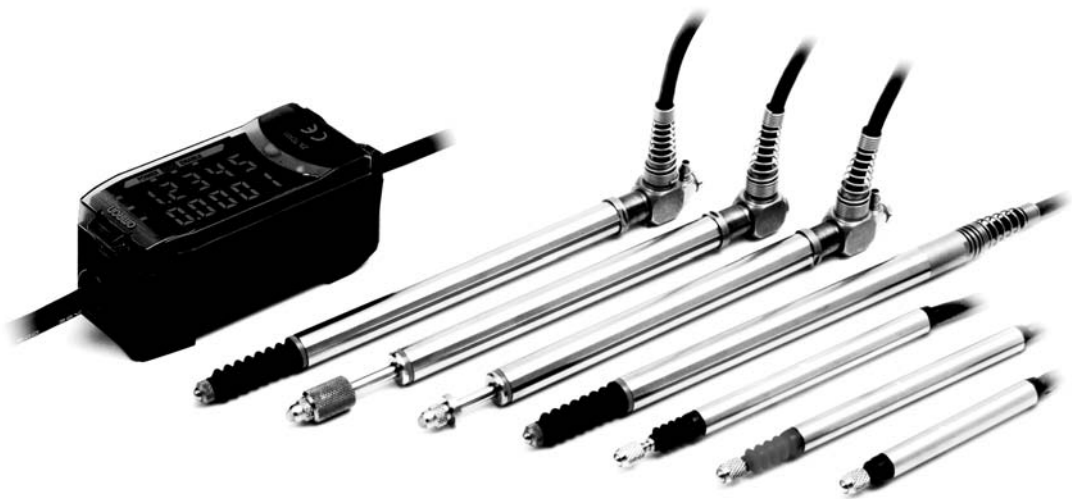

Cat. No. E346-E1-06

Terms and Conditions Agreement

Warranty, Limitations of Liability

Warranties

Exclusive Warranty

Omron's exclusive warranty is that the Products will be free from defects in materials and workmanship for a period of twelve months from the date of sale by Omron (or such other period expressed in writing by Omron). Omron disclaims all other warranties, express or implied.

Limitations

OMRON MAKES NO WARRANTY OR REPRESENTATION, EXPRESS OR IMPLIED, ABOUT NON-INFRINGEMENT, MERCHANTABILITY OR FITNESS FOR A PARTICULAR PURPOSE OF THE PRODUCTS. BUYER ACKNOWLEDGES THAT IT ALONE HAS DETERMINED THAT THE PRODUCTS WILL SUITABLY MEET THE REQUIREMENTS OF THEIR INTENDED USE.

Buyer Remedy

Omron's sole obligation hereunder shall be, at Omron's election, to (i) replace (in the form originally shipped with Buyer responsible for labor charges for removal or replacement thereof) the non-complying Product, (ii) repair the non-complying Product, or (iii) repay or credit Buyer an amount equal to the purchase price of the non-complying Product; provided that in no event shall Omron be responsible for warranty, repair, indemnity or any other claims or expenses regarding the Products unless Omron's analysis confirms that the Products were properly handled, stored, installed and maintained and not subject to contamination, abuse, misuse or inappropriate modification. Return of any Products by Buyer must be approved in writing by Omron before shipment. Omron Companies shall not be liable for the suitability or unsuitability or the results from the use of Products in combination with any electrical or electronic components, circuits, system assemblies or any other materials or substances or environments. Any advice, recommendations or information given orally or in writing, are not to be construed as an amendment or addition to the above warranty.

See <http://www.omron.com/global/> or contact your Omron representative for published information.

Limitation on Liability; Etc

OMRON COMPANIES SHALL NOT BE LIABLE FOR SPECIAL, INDIRECT, INCIDENTAL, OR CONSEQUENTIAL DAMAGES, LOSS OF PROFITS OR PRODUCTION OR COMMERCIAL LOSS IN ANY WAY CONNECTED WITH THE PRODUCTS, WHETHER SUCH CLAIM IS BASED IN CONTRACT, WARRANTY, NEGLIGENCE OR STRICT LIABILITY.

Further, in no event shall liability of Omron Companies exceed the individual price of the Product on which liability is asserted.

Application Considerations

Suitability of Use

Omron Companies shall not be responsible for conformity with any standards, codes or regulations which apply to the combination of the Product in the Buyer's application or use of the Product. At Buyer's request, Omron will provide applicable third party certification documents identifying ratings and limitations of use which apply to the Product. This information by itself is not sufficient for a complete determination of the suitability of the Product in combination with the end product, machine, system, or other application or use. Buyer shall be solely responsible for determining appropriateness of the particular Product with respect to Buyer's application, product or system. Buyer shall take application responsibility in all cases.

NEVER USE THE PRODUCT FOR AN APPLICATION INVOLVING SERIOUS RISK TO LIFE OR PROPERTY WITHOUT ENSURING THAT THE SYSTEM AS A WHOLE HAS BEEN DESIGNED TO ADDRESS THE RISKS, AND THAT THE OMRON PRODUCT(S) IS PROPERLY RATED AND INSTALLED FOR THE INTENDED USE WITHIN THE OVERALL EQUIPMENT OR SYSTEM.

Programmable Products

Omron Companies shall not be responsible for the user's programming of a programmable Product, or any consequence thereof.

Disclaimers

Performance Data

Data presented in Omron Company websites, catalogs and other materials is provided as a guide for the user in determining suitability and does not constitute a warranty. It may represent the result of Omron's test conditions, and the user must correlate it to actual application requirements. Actual performance is subject to the Omron's Warranty and Limitations of Liability.

Change in Specifications

Product specifications and accessories may be changed at any time based on improvements and other reasons. It is our practice to change part numbers when published ratings or features are changed, or when significant construction changes are made. However, some specifications of the Product may be changed without any notice. When in doubt, special part numbers may be assigned to fix or establish key specifications for your application. Please consult with your Omron's representative at any time to confirm actual specifications of purchased Product.

Errors and Omissions

Information presented by Omron Companies has been checked and is believed to be accurate; however, no responsibility is assumed for clerical, typographical or proofreading errors or omissions.

Preface	Introduction, Contents, Precautions for Safe Use, Precautions for Correct Use, and How to Use This Manual	Preface
Section 1	Features	Section 1
Section 2	Preparations for Measurement	Section 2
Section 3	Basic Operation	Section 3
Section 4	Main Applications and Setting Methods	Section 4
Section 5	Detailed Settings	Section 5
Section 6	Auxiliary Functions	Section 6
Appendices	Troubleshooting, Specifications, Characteristic Data, etc.	Appendices
Index		Index

Operation Manual

**Smart Sensors
ZX-T Series**

Introduction

Thank you for purchasing an OMRON ZX-T-series Smart Sensor (High-precision Contact Type). This manual describes the functions, performance, and application methods for the ZX-T-series Smart Sensor. Observe the following items when using the Sensor

- To ensure safety, please read and understand this manual before using the Sensor.
- Keep this manual in an easily accessible location for quick reference when needed.

Contents

Terms and Conditions Agreement	1
Introduction	2
Contents	3
Precautions for Safe Use	7
Precautions for Correct Use	8
How to Use This Manual	10

Section 1 Features	13
ZX-T Features	14

Section 2 Preparations for Measurement	19
Basic Configuration	20
Part Names and Functions	21
Installing the Amplifier Unit	24
Installing Sensor Heads	26
Connections	30
Wiring Output Cables	34
Confirming Warm-up Completion	36
Pressing Force Alarm	37

Section 3 Basic Operation	39
Flow of Operation	40
Basic Knowledge for Operation	42
Function Transition Charts	47
Section 4 Main Applications and Setting Methods	51
Measuring Thickness	52
Measuring the Height of a Step and Flatness	57
Measuring Depth	62
Other Measurements	67
Section 5 Detailed Settings	69
Setting Number of Samples to Average	70
Using Hold Functions	71
Inverting Positive and Negative Values (Scale Inversion)	75
Entering Threshold Values	77
Linear Output	81
Calculating Measured Values	90
Using the Zero Reset Function	92
Error Output Function	98

Section 6 Auxiliary Functions	101
Changing the Number of Display Digits	102
Reversing the Display	103
Adjusting Display Brightness (ECO Display)	105
Key Lock Function	106
Correcting the Distance Display (Span Adjustment)	107
Initializing Settings Data	109

Appendices	111
Actuators	112
Troubleshooting	115
Error Messages and Countermeasures	116
Q&A	118
Glossary	119
Specifications and Dimensions	120
Characteristic Data (Reference Value)	131
Quick Reference for Displays	132

Index

Revision History

Precautions for Safe Use

Always observe the following precautions to ensure safety.

■ Environment

- Do not use the Smart Sensor in locations subject to explosive or flammable gases.
- To ensure safety in operation and maintenance, do not install the Smart Sensor near high-voltage equipment or power devices.

■ Power Supply and Wiring

- Do not impose voltages exceeding the rated voltage (12 to 24 VDC \pm 10%).
- When supplying power to the Sensor, make sure that the polarity of the power is correct, and do not connect to an AC power supply.
- Do not short-circuit the load for the open collector output.
- Do not lay the power supply cable for the Smart Sensor together with high-voltage lines or power lines. Doing so, or placing them into the same duct, can cause induction and lead to malfunction or damage.
- Always turn OFF the power supply before wiring and before connecting or disconnecting connectors.
- Use a DC power supply equipped with measures to counter generation of high voltages (safety overvoltage/undervoltage circuits) or use a UL Class 2 DC power supply. Do not ground the positive terminal on the secondary side (i.e., the DC side).

■ Settings

- When setting the threshold value with the Smart Sensor connected to an external device, turn ON the Amplifier Unit's judgement output hold input to prevent the judgement from being output to the external device.

■ Applicable standards

- EN61326-1
- Electromagnetic environment: Industrial electromagnetic environment (EN/IEC 61326-1 Table 2)
- There may be cases that current output or voltage output fluctuate within \pm 3 times of resolution when a sensor is experienced electromagnetic interference.

■ Others

- The ZX-L-series Smart Sensors (Laser Type), ZX-E-series Smart Sensors (Linear Proximity Type), and ZX-W-series Smart Sensors (Microwave Type) are not compatible. Do not use ZX-L, ZX-E, or ZX-W-series Smart Sensors together with ZX-T-series Smart Sensors.
- Do not attempt to disassemble, repair, or modify the Smart Sensor.
- When disposing of the Smart Sensor, treat it as industrial waste.

Precautions for Correct Use

Always observe the following precautions to prevent operation failures, malfunctions, and adverse effects on performance and equipment.

Smart Sensor Installation

■ Environment

Do not install the Smart Sensor in the following locations:

- Locations where the ambient temperature exceeds the rated temperature range.
- Locations subject to rapid changes in temperature (causing condensation).
- Locations where the relative humidity exceeds the range of 35% to 85%.
- Locations subject to corrosive or flammable gases.
- Locations where dust, salt, or metallic powder accumulate on the Sensor.
- Locations subject to direct vibration or impact.
- Locations subject to direct sunlight.
- Locations subject to exposure to water, oil, chemicals, etc.
- Locations subject to strong electromagnetic or electrical fields.
- Locations subject to water vapor.

Installation and Handling of Components

■ Power Supply and Wiring

- The total length of the Sensor cable or Amplifier cable must be 10 m or less.
Use a ZX-XC□A Extension Cable (order separately) if required to extend the cable from the Sensor. Use a shielded cable to extend the Amplifier cable. The shielded cable must be the same as that of the Amplifier cable.
- When using a commercially available switching regulator, ground the FG (frame ground) terminal. (ZX-TDS01T and ZX-TDS04T-□)
- If the power supply line is subject to surges, connect a surge absorber that meets the conditions of the application environment.
- When connecting multiple Amplifier Units, connect the linear grounds of all the Amplifier Units.
- The Sensor Head is not flame resistant (ZX-TDS10T-□□).

■ Sensor Head

- The Sensor Head is a high-precision device. Do not drop it or otherwise expose it to shock.
- Do not expose the plunger to forces exceeding the limits in the following diagram. Doing so may damage the plunger.

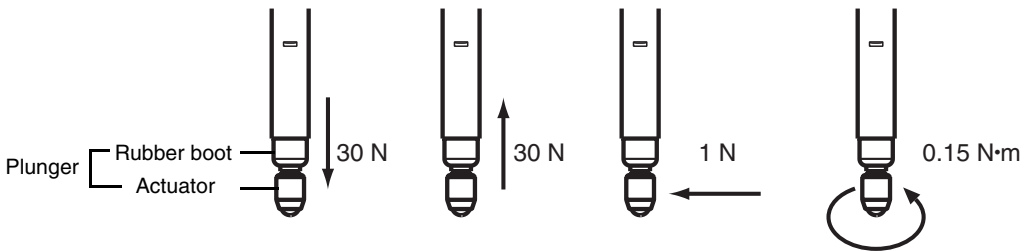

- Take measurements within the range that does not set off the Pressing Force Alarm.
- Do not remove the rubber boot. Without the rubber boot, foreign matter may enter the Sensor Head, possibly causing the Sensor Head to malfunction.
- Mount the Sensor Head and Preamplifier in the specified location and under the specified load. Excessive force during installation may damage the Sensor Head or Preamplifier.
- Replace worn actuators.



Replacing Actuators, p. 113

- Do not use the Sensor to measure objects that are revolving or moving (i.e., dynamic measurement).
- Do not use air pressure outside the rated range when using a vacuum retract (VR) or air push (AP). The measured pressure will fluctuate due to the air pressure, so the air pressure must be regulated. An air vacuum device and a solenoid are required (ZX-TDS10T-V□ only).
- Supply dry air with filtration of 5 μm max. (ZX-TDS10T-V□ only).
- The ZX-TDS10T-L can be mounted only facing downward.

■ Warming Up

After turning ON the power, allow the Smart Sensor to warm up for 15 minutes minimum prior to use. The circuitry is not stable immediately after turning the power ON, and the values gradually change until the Sensor is completely warmed up.

■ Maintenance and Inspection

- Always turn OFF the power supply before adjusting or removing the Sensor Head.
- Do not use thinners, benzine, acetone, or kerosene to clean the Sensor Head or Amplifier Unit.

How to Use This Manual

Page Format

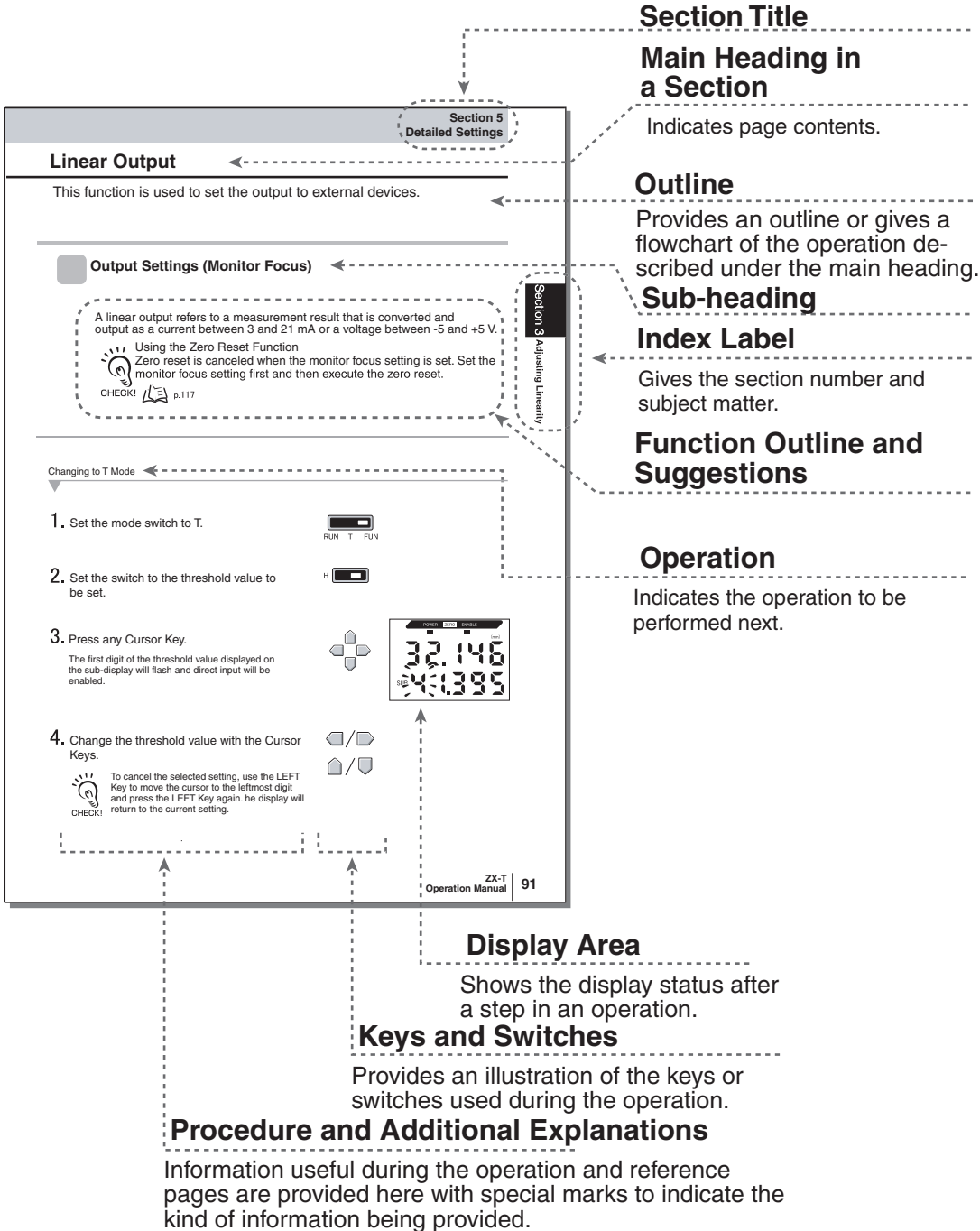

* This page does not actually exist in this manual.

Notation

■ Menus

Items that appear on the digital displays are set in ALL-CAPS.

■ Procedures

The order for the procedures is indicated by numbered steps.

■ Visual Aids



Provides information on important operating procedures, gives advice on how to use functions, and highlights important performance information.



Indicates pages with relevant information.



Indicates useful information for when problems arise.

Section 1

FEATURES

 ZX-T Features

14

ZX-T Features

The ZX-T-series Smart Sensor measures the height of sensing objects and minute steps (i.e., height differences).

Example: Measuring Electronic Components Dimensions

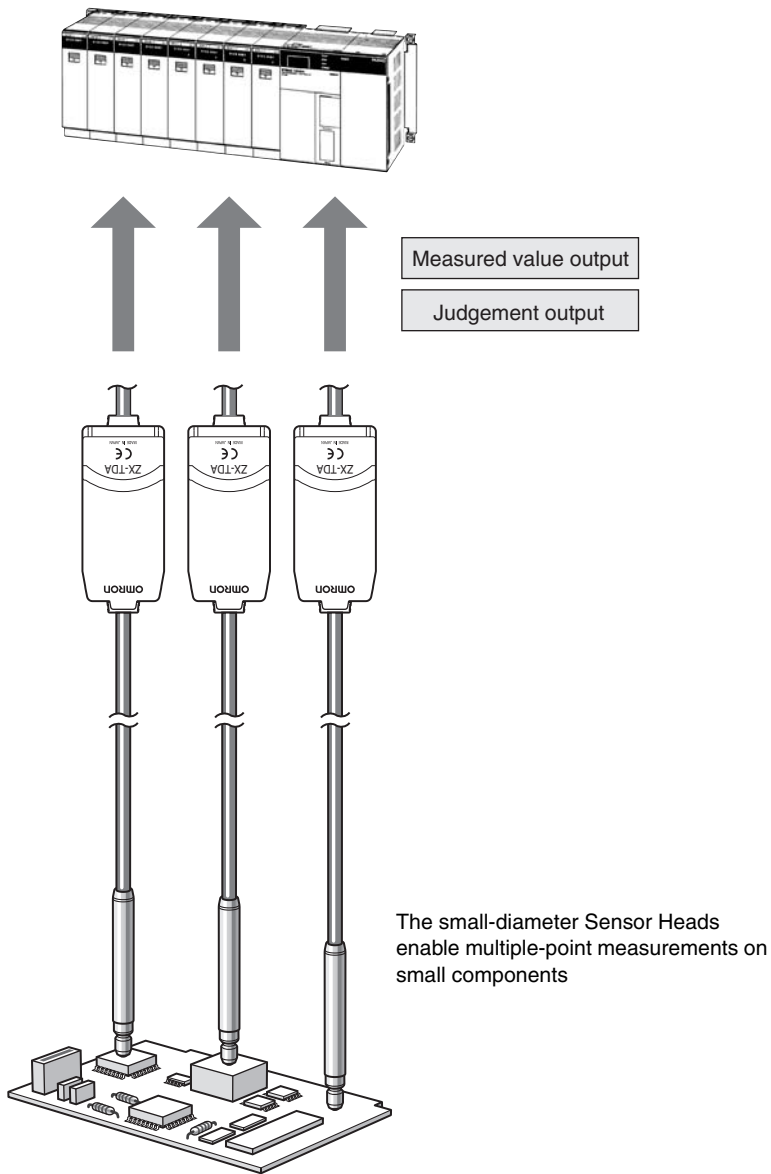

Many, Simple Functions

■ Measurement Ready at Power ON

The Smart Sensor can be used simply by installing and wiring it. Simply turn ON the power and it's ready to operate.

The measurement distance is displayed on the Amplifier Unit.

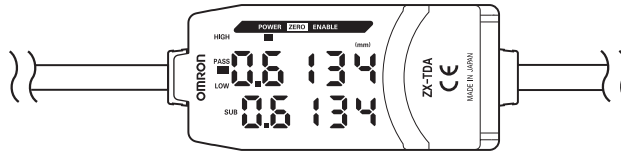

■ Simple Calculation Settings

Use Calculating Units to easily calculate step heights and thicknesses through multi-point measurements.

 p. 51

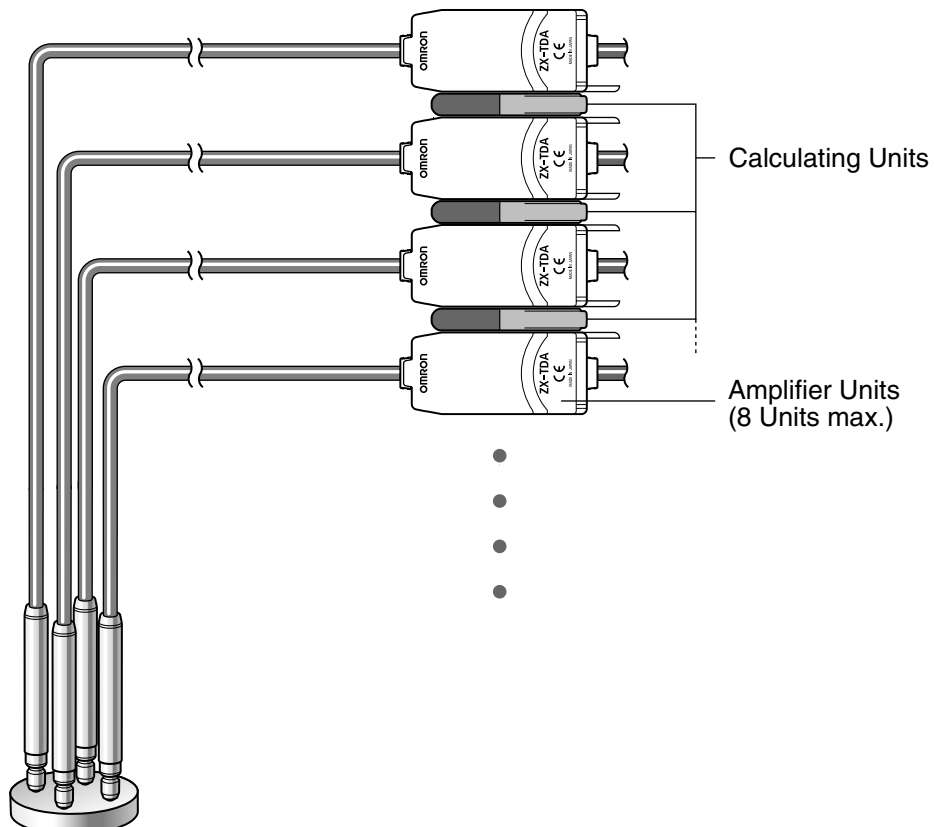

Compatibility between Sensor Heads and Amplifier Units

Amplifier Units do not need to be changed when Sensor Heads are changed for maintenance or to switch to new products.

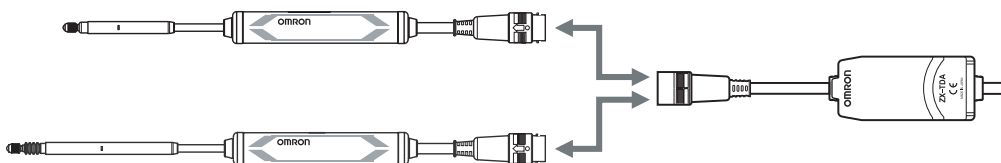

Extendable Sensor Head Cables

An extension cable with a maximum length of 8 m can be connected. The ZX-XC-A Extension Cable is required to extend the Sensor Head cable.

 p. 20

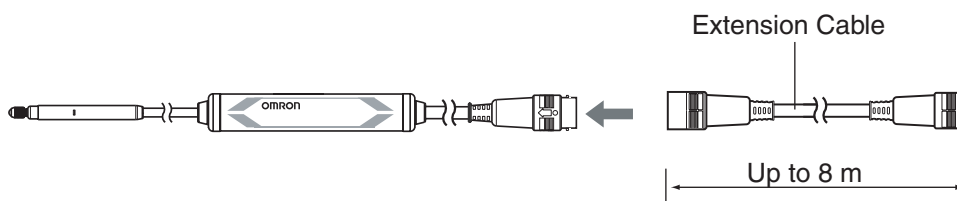

Convenient Notification Functions

■ Preventing Malfunctions Caused by Excessive Pressing Force

Malfunctions caused by excessive plunger pressing force for unexpected measurements can be detected in advance and a signal can be output to stop the measurement or otherwise prevent malfunction.

 p. 37.

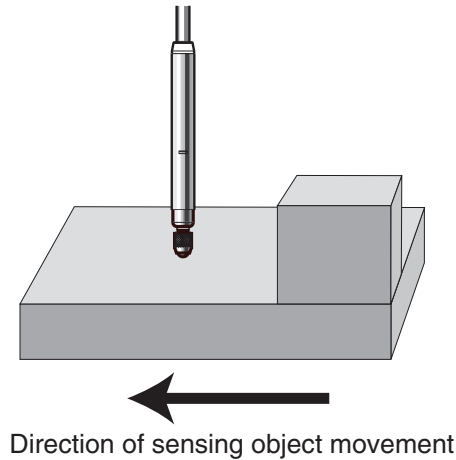

■ Warming Up Display

The display shows the warming-up status when the power is turned ON. This enables measurements to be started when the status has stabilized after warming up has been completed.

 p. 36.

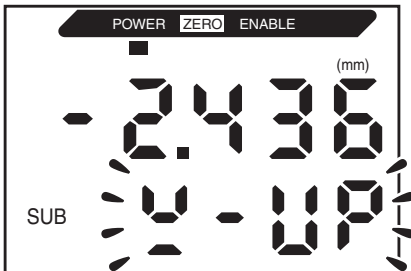

The sub-display flashes *W-UP* during warm-up.

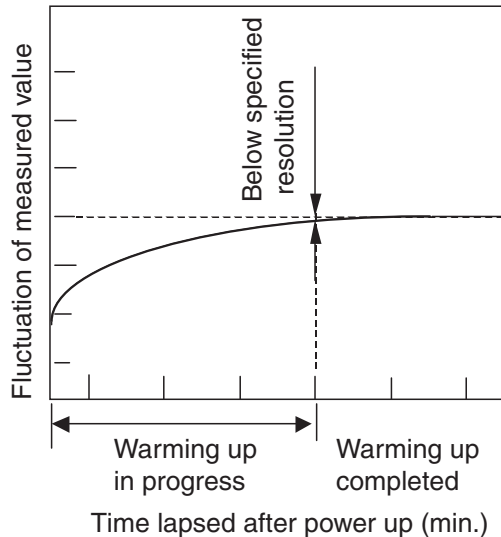

Monitoring Measurement Status

■ Confirm Measurement Status on a Personal Computer

Use an Interface Unit and Smart Monitor V3 to view measurement waveforms and log measurement data on a personal computer. This function is useful for making on-site measurement adjustments and for day-to-day quality control.

 p. 20

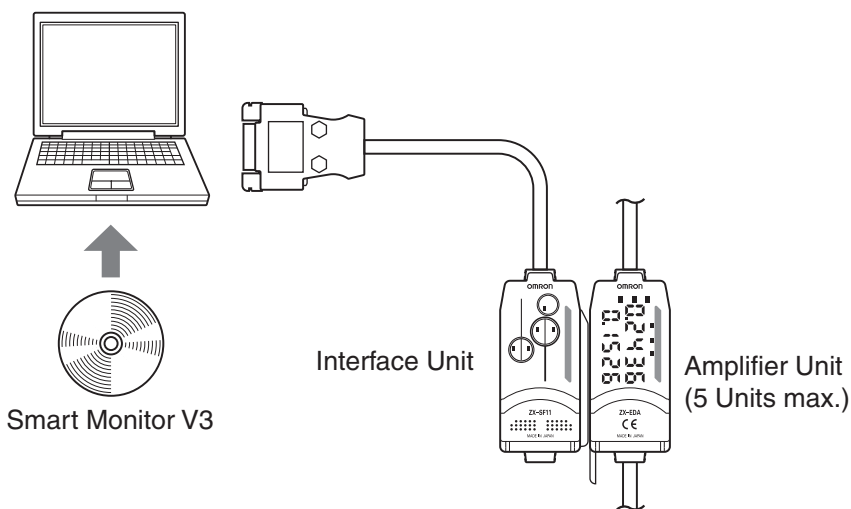

Section 2

PREPARATIONS FOR MEASUREMENT

☒ Basic Configuration	20
☒ Part Names and Functions	21
☒ Installing the Amplifier Unit	24
☒ Installing Sensor Heads	26
☒ Connections	30
☒ Wiring Output Cables	34
☒ Confirming Warm-up Completion	36
☒ Pressing Force Alarm	37

Basic Configuration

The basic configuration of the ZX-T-series Smart Sensors is shown below.



ZX-L-series Smart Sensors (Laser Type), ZX-E-series Smart Sensors (Linear Proximity Type), and ZX-W-series Smart Sensors (Microwave Type) are not compatible. Do not use ZX-L-series, ZX-E-series, or ZX-W-series Smart Sensors together with ZX-T-series Smart Sensors.
CHECK!

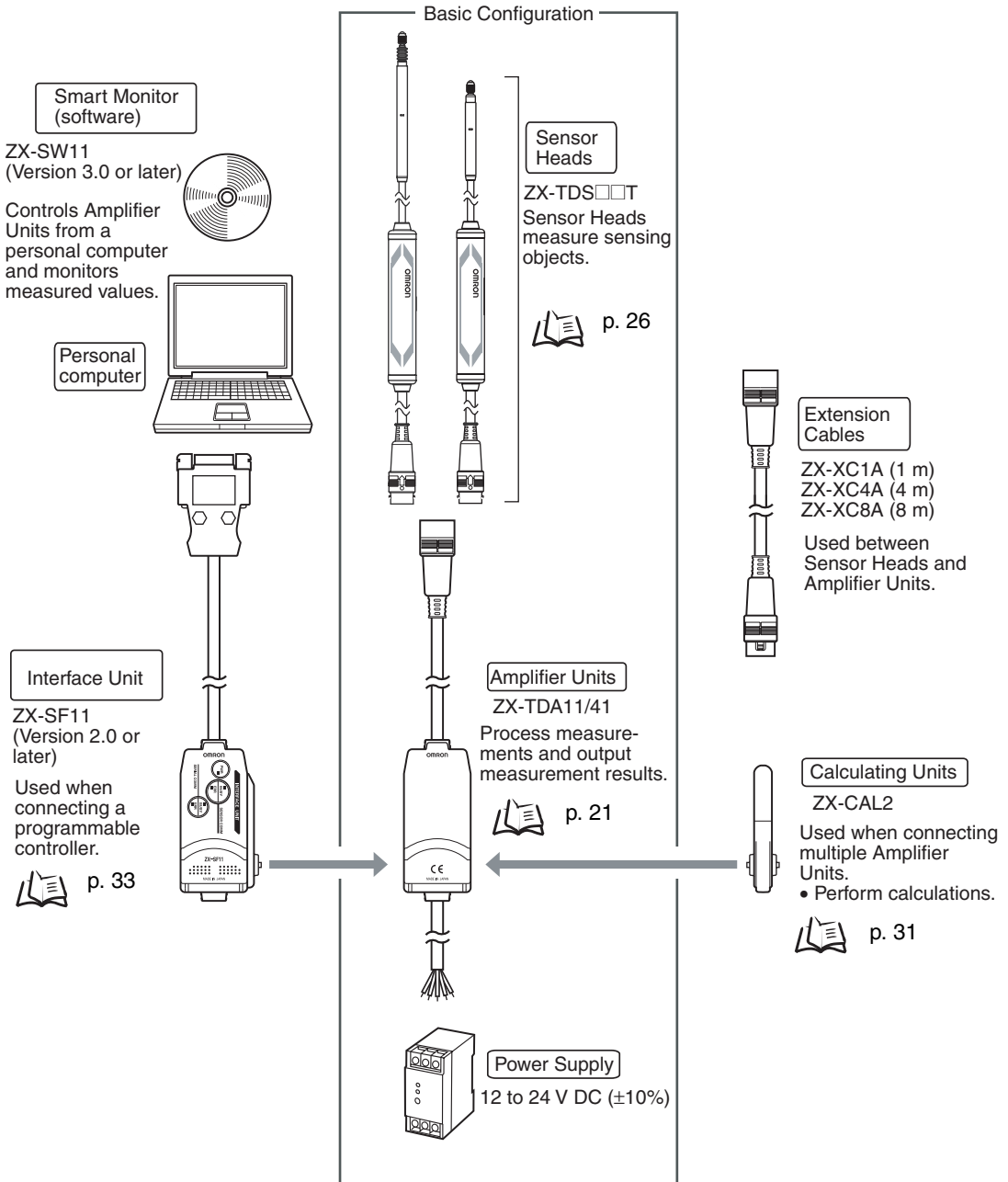



Part Names and Functions

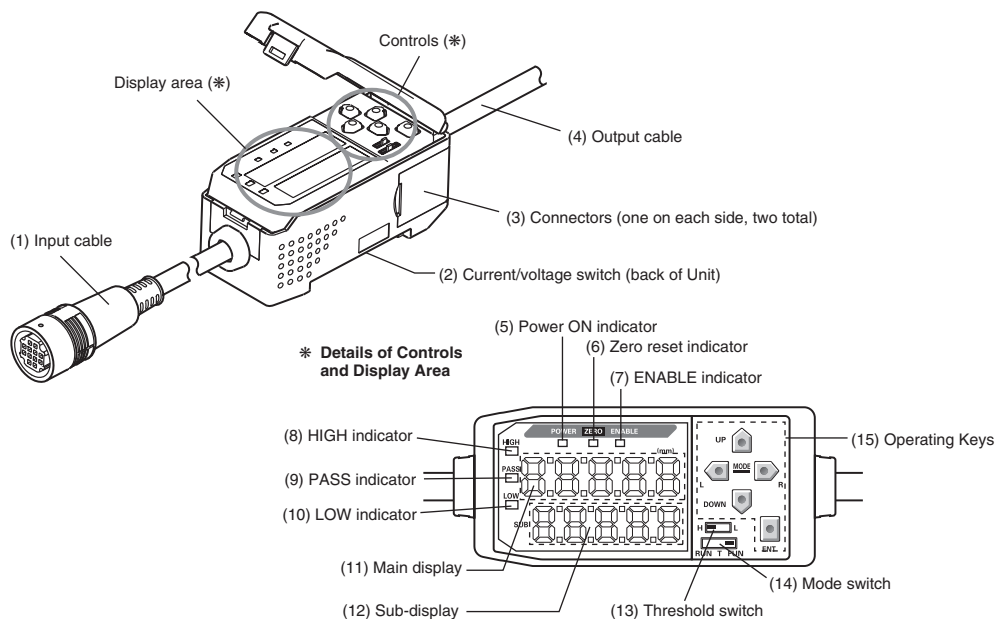

Amplifier Units

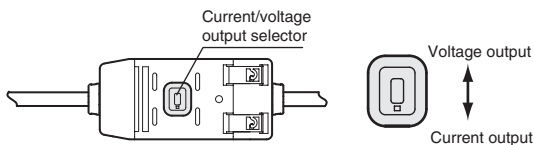

- (1) The input cable connects the Sensor Head.
- (2) The current/voltage switch selects either a current or voltage linear output.



Monitor focus settings are also required when switching the output.  p. 81

- (3) The connectors connect Calculation and Interface Units.
- (4) The output cable connects to the power supply and external devices, such as sync sensors or programmable controllers.
- (5) The Power ON indicator lights when the power is turned ON.
- (6) The Zero Reset indicator lights when the zero reset function is enabled.
- (7) The ENABLE indicator lights when the measurement result is within the rated measurement distance.
- (8) The HIGH indicator lights when the judgement result is HIGH.
- (9) The PASS indicator lights when the judgement result is PASS.
- (10) The LOW indicator lights when the judgement result is LOW.
- (11) The main display shows measured values and function names.
- (12) The sub-display shows additional information and function settings for measurements.  Reading Displays, p. 43
- (13) The threshold switch selects whether to set (and display) the HIGH or LOW threshold.
- (14) The mode switch selects the operating mode.  Switching Modes, p. 42
- (15) The Control Keys set measurement conditions and other settings.

 Key Operations, p. 44

Sensor Heads

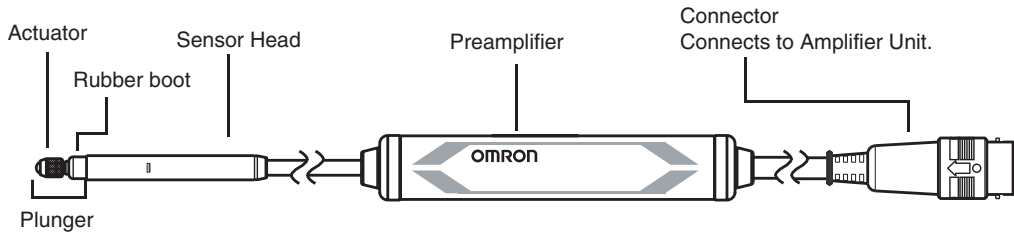

Calculating Units

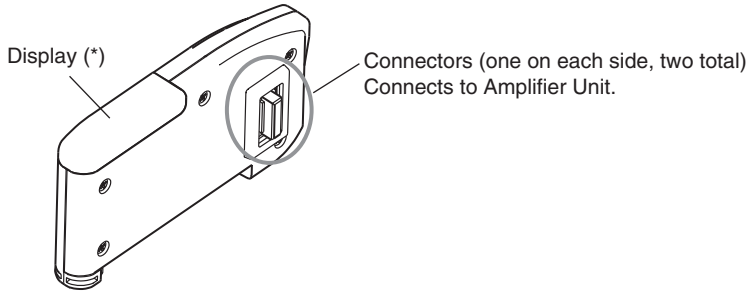

* Display Detail

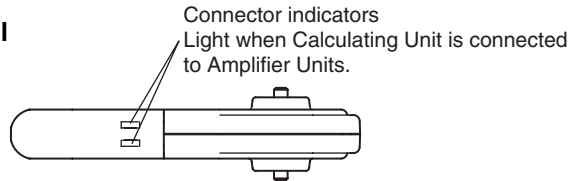

Interface Units

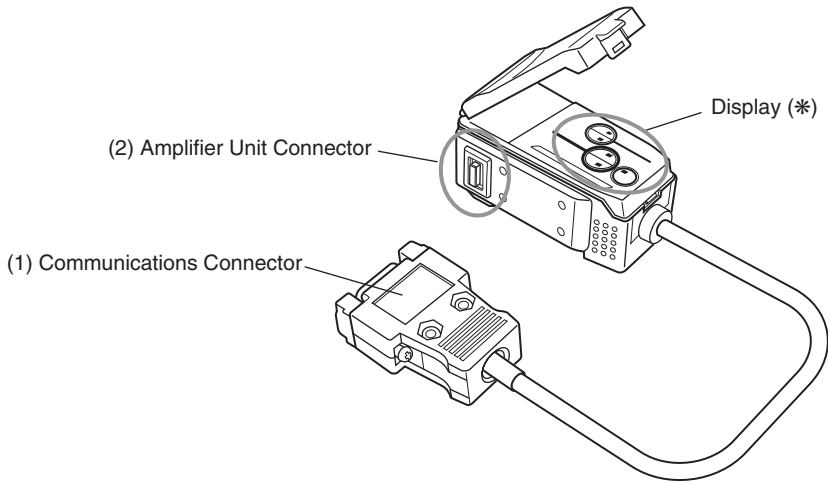

* Display Detail

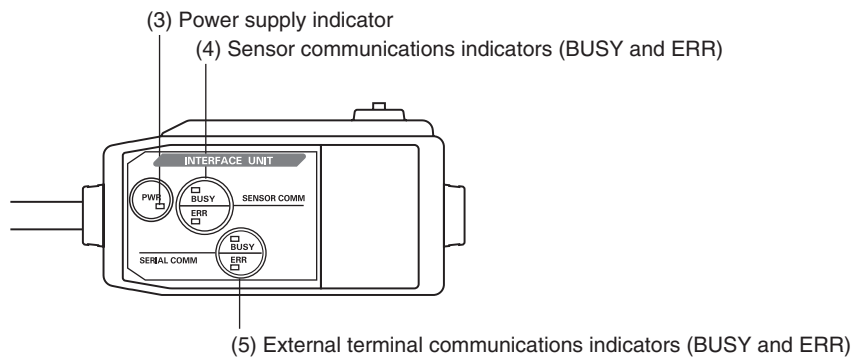

- (1) The communications connector connects the communications cable to the Programmable Controller.
- (2) The Amplifier Unit connector connects to the Amplifier Unit.
- (3) The power supply indicator lights when the power is turned ON.
- (4) BUSY: Lights during communications with the Smart Sensor.
ERR: Lights if an error occurs during communications with the Smart Sensor.
- (5) BUSY: Lights during communications with the Programmable Controller.
ERR: Lights if an error occurs during communications with the Programmable Controller.

Installing the Amplifier Unit

Amplifier Units can be easily mounted to 35-mm DIN Track.

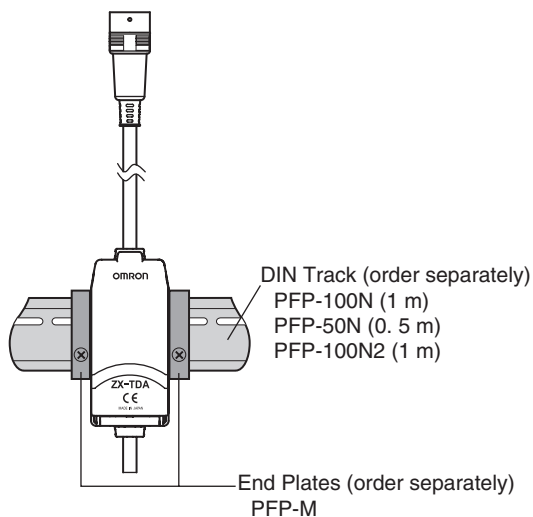

■ Installation

Hook the connector end of the Amplifier Unit on the DIN Track and press in at the bottom until the Unit locks into place.

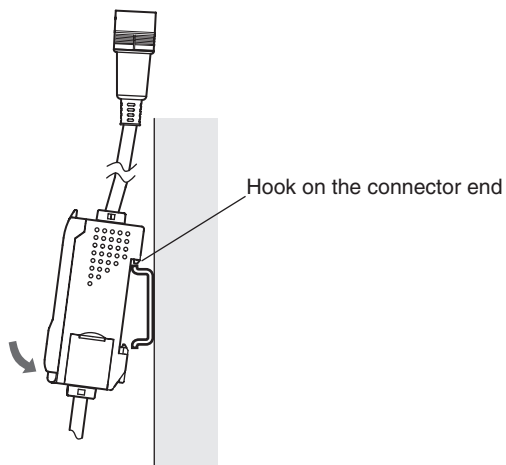

CHECK!

Always hook the connector end of the Amplifier Unit on the DIN Track first. Mounting strength may decrease if the output cable end is hooked on the DIN Track first.

■ Removal Method

Push the Amplifier Unit up and pull out from the connector end.

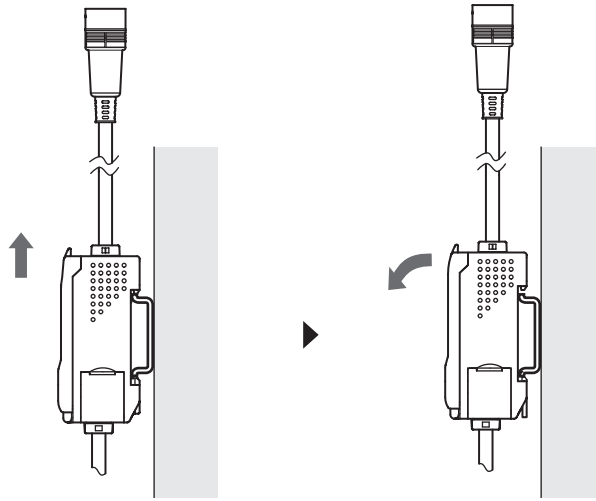

Installing Sensor Heads

This section describes how to install Sensor Heads and Preampifiers.



Secure the connector so that it is not subjected to vibration or shock.

CHECK!

Sensor Heads

■ Installation



CHECK!

Do not clamp the Sensor Head directly on the end of the screw. Otherwise, the Sensor Head may be damaged.

■ Mounting Jig

ZX-TDS01T/TDS04T-□

Mount the Sensor Head using M3 screws and a mounting torque between 0.6 and 0.8 N·m.

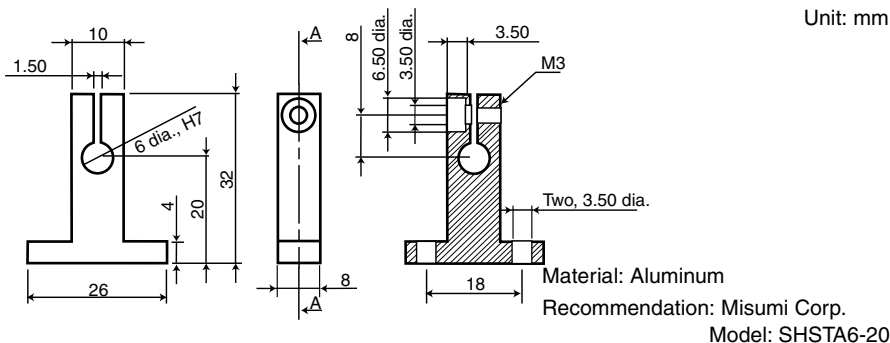

ZX-TDS10T-□□

Mount the Sensor Head using M4 screws and a mounting torque between 2 and 3 N·m.

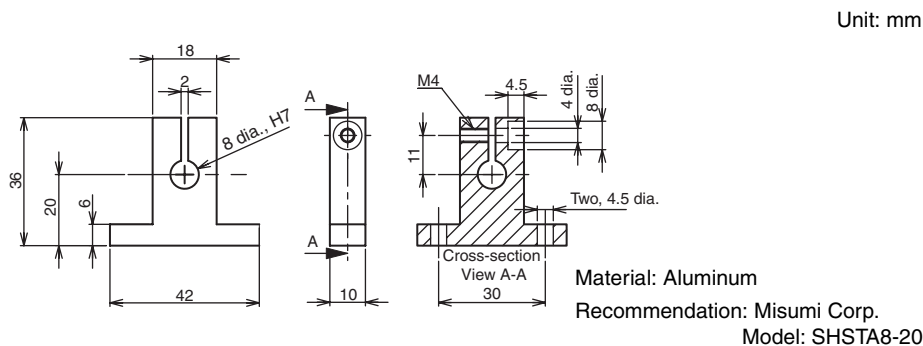

- Mounting Jig for an 8-diameter Stand

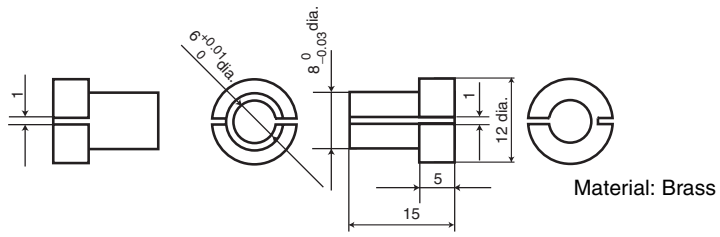



When preparing a mounting jig, set the support tightening force to 100 N maximum.

CHECK!

• Mounting with 3-point Support

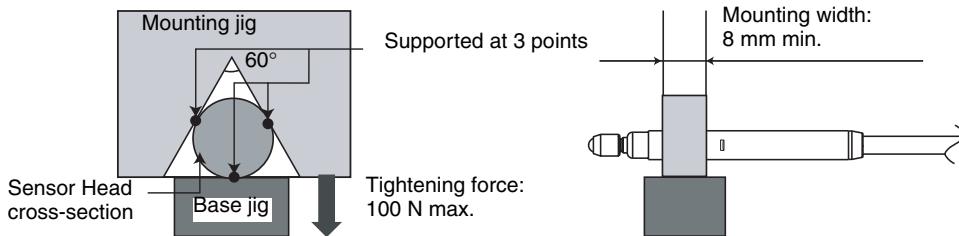

■ Mounting Position

Secure the Sensor Head along the section indicated by A.

If the Sensor Head will be used in an area with extreme temperature fluctuations, secure the Sensor Head along the section indicated by B. This will minimize the effects of expansion and contraction that accompany temperature fluctuations.

Unit: mm

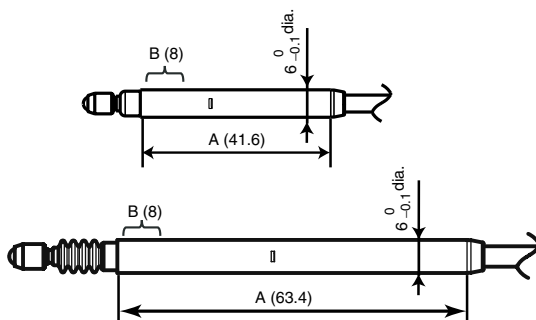

Check to see how the plunger moves after the Sensor Head is fastened in place. It will not move properly if the Sensor Head is fastened too tightly.

CHECK!

Preamplifiers

■ Installation

Use the enclosed Preamplicifier Mounting Bracket.



The Preamplicifier can also be mounted to 35-mm DIN Track.

Use the ZX-XBT2 Preamplicifier DIN Track Mounting Bracket (order separately) when mounting the Preamplicifier to DIN Track.

1. Use M3 screws to fix the enclosed Preamplicifier mounting bracket.

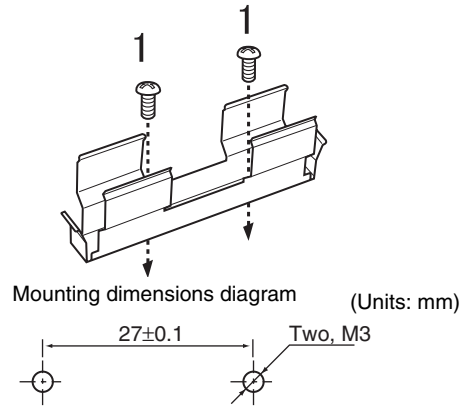

2. Snap one end of the Preamplicifier into the bracket.
3. Then snap the other end of the Preamplicifier into the bracket.

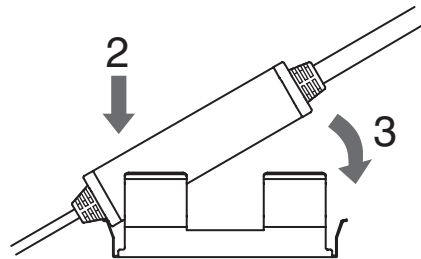

■ Removal Method

Hold the center of the Preamplicifier and lift.

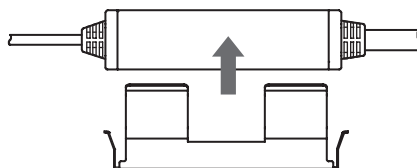

Connections

This section describes how to connect component parts of the Smart Sensor.



CHECK!

Turn OFF the power supply to the Amplifier Unit before connecting or removing components. The Smart Sensor may malfunction if components are connected or removed while the power is ON.



Sensor Heads



CHECK!

Do not touch the terminals inside the connector.

■ Connection Method

Push the Sensor Head connector into the Amplifier Unit connector until it locks.

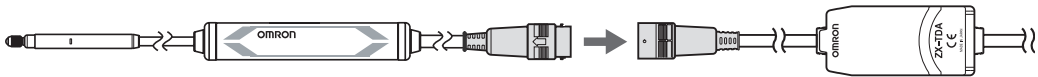

■ Removal Method

When disconnecting the Sensor Head, hold the connector ring and the Amplifier Unit connector and pull them straight out.



CHECK!

Do not pull only on the connector ring, because the input cable of the Amplifier Unit may be damaged.

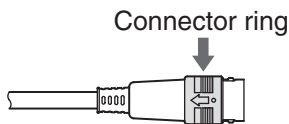

CHECK!

All settings on the Amplifier Unit will be cleared when the Sensor Head is replaced with a different model.

Calculating Units

Use Calculating Units to connect Amplifier Units when making calculations between Amplifier Units.

A maximum of 8 Amplifier Units can be connected using Calculating Units.



Provide power to all connected Amplifier Units.
Connect the linear grounds of all Amplifier Units to each other.

CHECK!

■ Connection Method

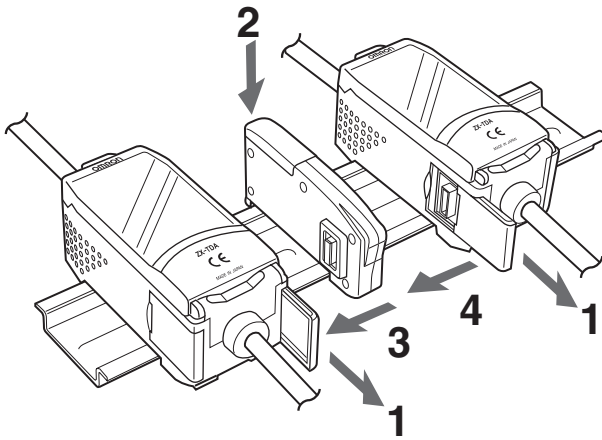

- 1.** Open the connector covers on the Amplifier Units.
Open the connector covers by lifting and sliding them open.
- 2.** Mount the Calculating Unit to the DIN Track.
- 3.** Slide and connect the Calculating Unit to the Amplifier Unit connector.
- 4.** Slide and connect the second Amplifier Unit to the Calculating Unit connector.

Perform the above operation in the reverse order to remove Calculating Units.

■ Channel Numbers of Amplifier Units

The following diagram shows the channel numbers when multiple Amplifier Units are connected.

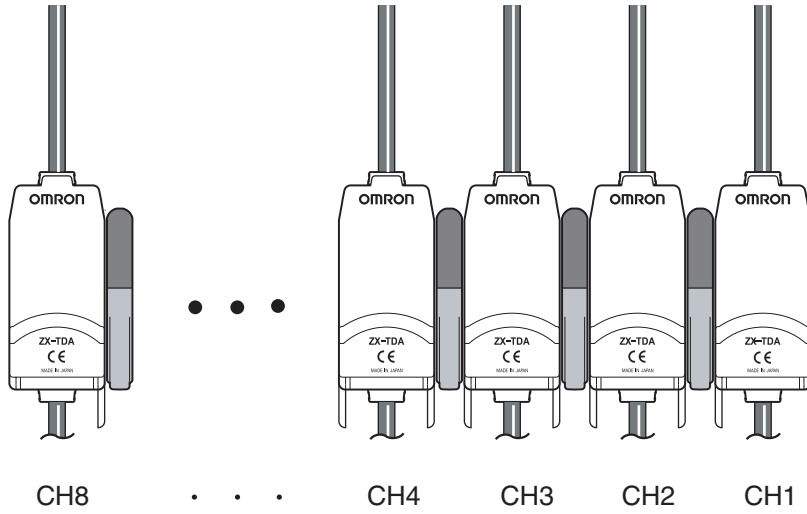

Interface Units

Use an Interface Unit to connect a Programmable Controller to the Smart Sensor system.

Up to five Amplifier Units can be connected.

■ Connection Method

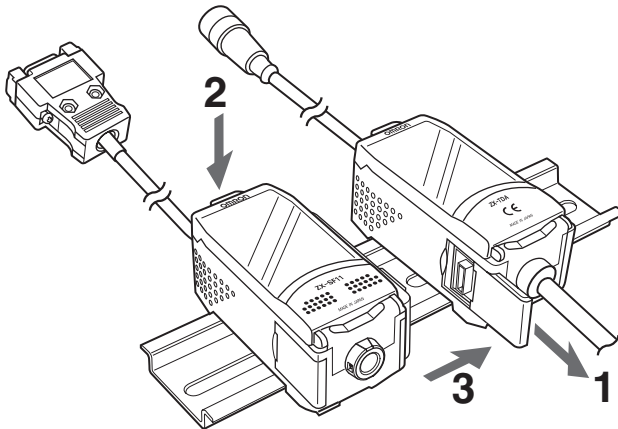

- 1.** Open the connector cover on the Amplifier Unit.
Open the connector cover by lifting and sliding it open.
- 2.** Mount the Interface Unit to the DIN Track.
- 3.** Slide and connect the Interface Unit to the Amplifier Unit connector.

Perform the above operation in the reverse order to remove Interface Units.



When multiple Amplifier Units are used, connect the Interface Unit to the Amplifier Unit with the highest channel number.

Wiring Output Cables

The following diagram shows the wires in the output cable.



Wire the output cable correctly. Incorrect wiring may damage the Smart Sensor.

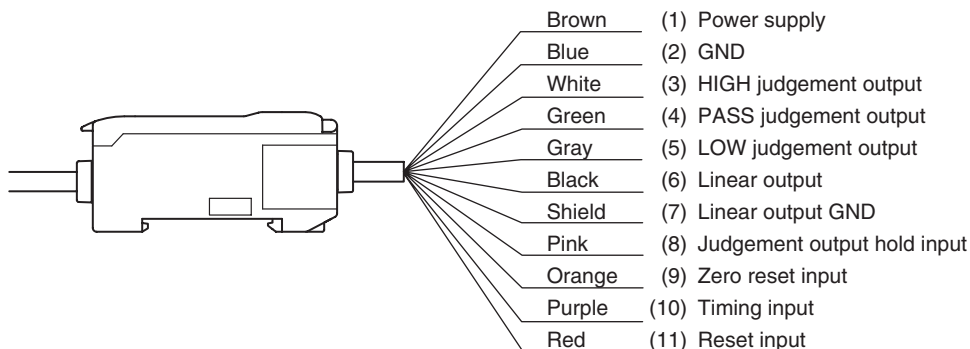

- (1) A 12- to 24-VDC ($\pm 10\%$) power supply is connected to the power supply terminals. When using an Amplifier Unit with a PNP output, the power supply terminal is also the common I/O terminal for all I/O except for the linear output.



Use a stabilized power supply separate from other devices and power systems for the Amplifier Unit, particularly when high resolution is required.

Use a DC power supply equipped with measures to counter generation of high voltage (safety overvoltage/undervoltage circuits) or use a UL Class 2 DC power supply. Do not ground the positive terminal on the secondary side (i.e., the DC side).

- (2) The GND terminal is the 0-V power supply terminal. When using an Amplifier Unit with an NPN output, the GND terminal is also the common I/O terminal for all I/O except for the linear output.
- (3) The HIGH judgement output outputs HIGH judgement results. This output also turns ON when the Pressing Force Alarm operates.
- (4) The PASS judgement output outputs PASS judgement results.
- (5) The LOW judgement output outputs LOW judgement results. This output also turns ON when the Pressing Force Alarm operates.
- (6) The linear output outputs a current or voltage output in accordance with the measured value.
- (7) The linear output GND terminal is the 0-V terminal for the linear output.



- Use a different ground for the linear output from the normal ground.
- Always ground the linear output terminal even when linear output is not used.

- (8) When the judgement output hold input is turned ON, the judgement outputs are held and not output to the external devices. Turn the judgement output hold input ON when setting threshold values.



When setting threshold values while connected to external devices, turn ON the Amplifier Unit's judgement output hold input to prevent the outputs to external devices from changing.

- (9) The zero reset input is used to execute and clear zero reset

- (10) The timing input is for signal input from external devices. Use it for hold function timing.
- (11) The reset input resets all measurement processing and outputs.

I/O Circuit Diagrams

■ NPN Amplifier Unit

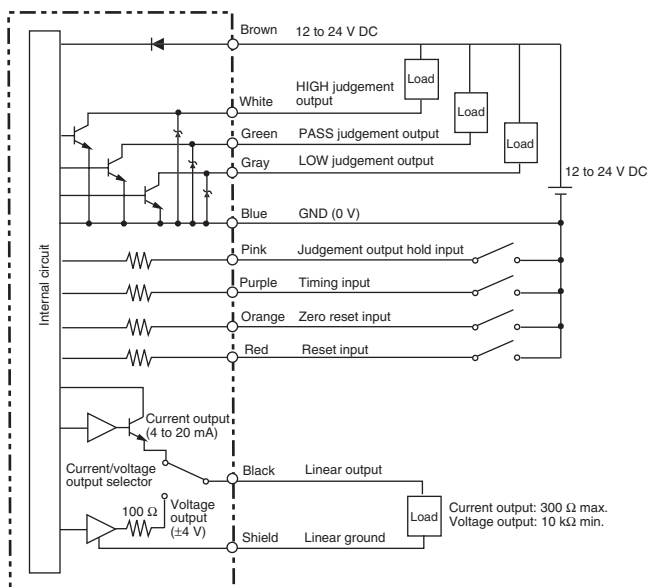

■ PNP Amplifier Unit

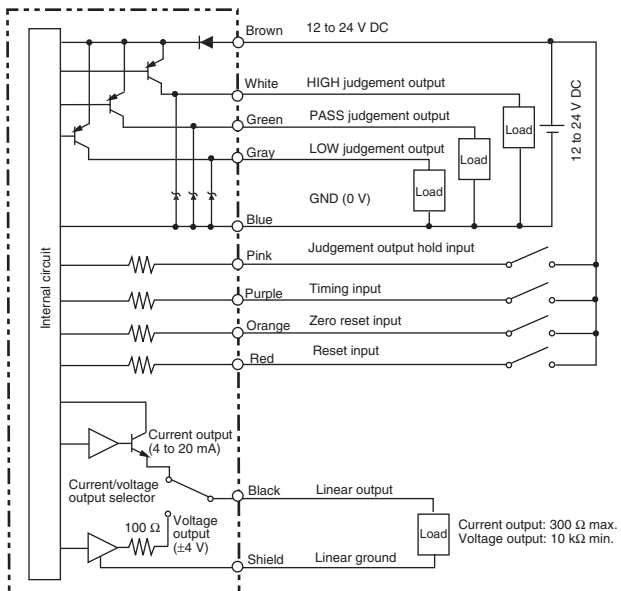

Confirming Warm-up Completion

When the power is turned ON in RUN or T Mode, the sub-display will flash *W-UP* to show that the Sensor is warming up. Warm-up requires approximately 1 to 15 minutes. When warming up has been completed, the normal display will be shown.

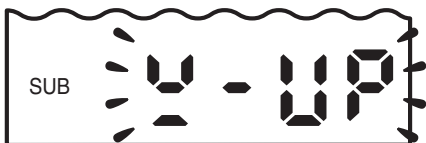

Measurement operations can be performed while in warm-up display status, but the precision of measurements before warming up has been completed will be low. For high-precision measurements, wait until warming up has been completed.

Pressing Force Alarm

When the pressing force of the plunger exceeds the rated measurement distance by 1% or more, OVER will be displayed on the main display to indicate that the plunger is pressing too hard. (The HIGH and LOW indicators will also light.)

Too much pressing force will cause damage. Adjust the detection position of the Sensor Head.

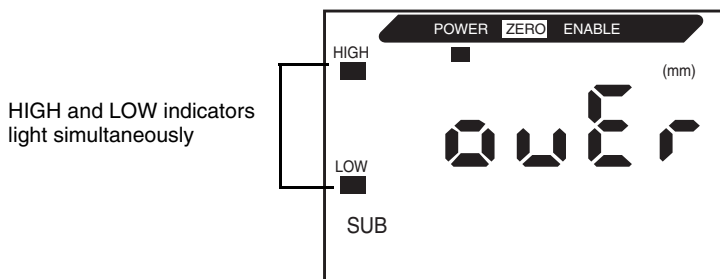

Be careful if an external device is connected because the HIGH and LOW judgement outputs will also turn ON simultaneously when the Pressing Force Alarm operates.

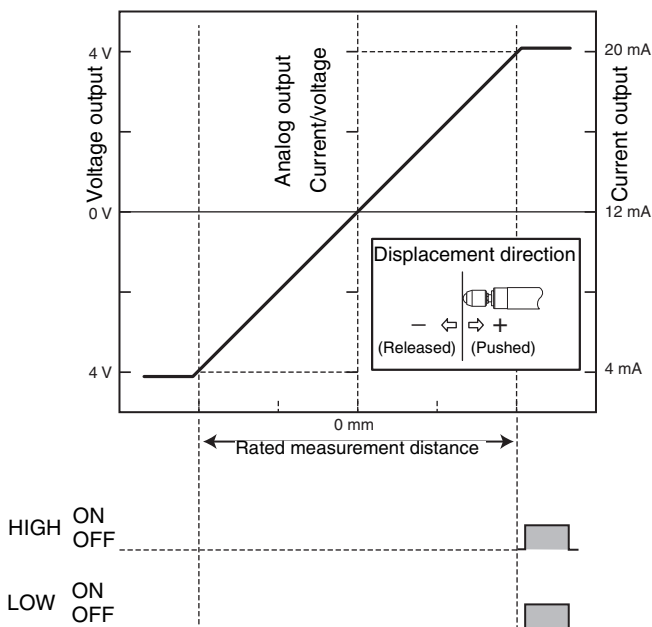







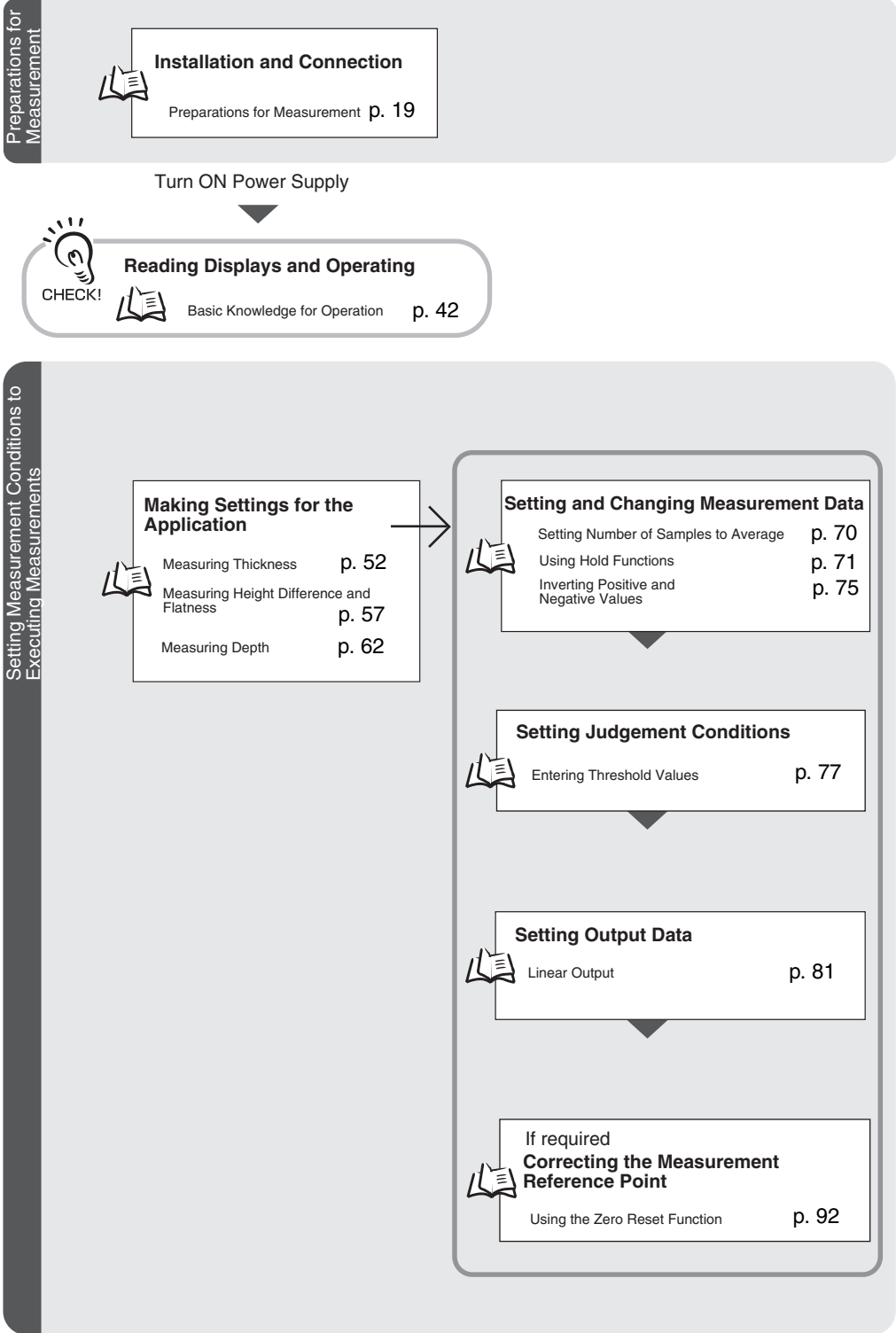

Section 3

BASIC OPERATION



☒	Flow of Operation	40
☒	Basic Knowledge for Operation	42
	Switching Modes	42
	Reading Displays	43
	Key Operations	44
	Setting Conditions	45
	Inputting Numerals	46
☒	Function Transition Charts	47

Flow of Operation



 If Problems Occur	 Error Messages
 Abnormal Operation Troubleshooting p. 115	 Error Messages and Countermeasures p. 116
 Unknown Terms	 Meaning of Digital Display
 Glossary p. 119	 Quick Reference for Digital Displays p. 132





Applied Settings

 Calculating Measured Values p. 90
 Using the Zero Reset Function p. 92
 Changing the Number of Display Digits p. 102

Changing Settings

 Initializing Settings Data p. 109
--

Additional Functions

 Using ECO Display Function p. 105
 Reversing the Display p. 103
 Key Lock Function p. 106
 Correcting the Distance Display p. 107

Basic Knowledge for Operation

Switching Modes

The ZX-T has three modes. Use the Mode Switch on the Amplifier Unit to switch between modes. Switch to the desired mode before starting operation.

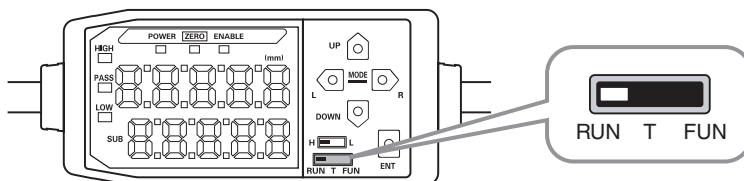

Mode	Description
RUN	Normal operation mode
T	Mode for setting the threshold values
FUN	Mode for setting measurement conditions.

 Function Transition Charts, p. 47

Reading Displays

The data displayed on the main and sub-displays depends on the mode currently selected. When the power is first turned ON after shipment, RUN mode data is displayed.

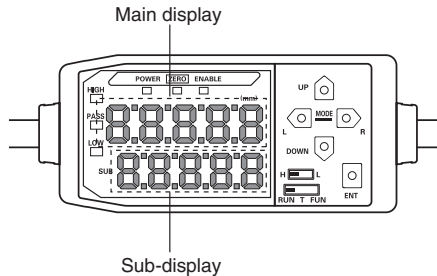

Mode	Main Display	Sub-display
RUN	Displays the measured value (the value after measurement conditions have been reflected). For example, when the hold function is set, the held value will be displayed.	Changes between displaying the present value (actual measured value), threshold value, output value, and resolution in order when the Control Keys are pressed. Threshold Value Display Displays either the HIGH or LOW threshold value, depending on the position of the threshold switch. <div style="text-align: center;"> </div> The monitor focus setting determines whether the value is output as voltage or current. Output Settings (Monitor Focus), p. 81
T	Displays the measured value (the value after the measurement conditions have been reflected). For example, when the hold function is set, the held value will be displayed.	Displays the threshold value for the threshold being set. Displays either the HIGH or LOW threshold value, depending on the position of the threshold switch. <div style="text-align: center;"> </div>
FUN	Displays the function names in order when the Control Keys are pressed.	Displays the setting for the function displayed on the main display.

Function Transition Charts, p. 47

■ Alphabet Display Format

The alphabet appears on the main and sub-displays as shown in the following table.

A	B	C	D	E	F	G	H	I	J	K	L	M
A	b	c	d	E	F	G	h	I	J	K	L	M
N	O	P	Q	R	S	T	U	V	W	X	Y	Z
n	o	P	q	r	S	t	U	v	W	x	Y	Z



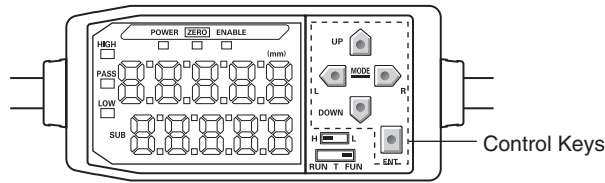

Key Operations

Use the Control Keys to change the display and set measurement conditions.



The mode currently selected determines the key functions.

 Switching Modes, p. 42

Key		Function		
		RUN Mode	T Mode	FUN Mode
Cursor Keys	 LEFT Key	Changes sub-display content.	Used when selecting numeral digits.	Function changes depending on setting. • Switches function display. • Selects numeral digit. • Stops setting.
	 RIGHT Key			
	 UP Key	Performs timing input.		
	 DOWN Key	Resets input.		
 ENT Key	Performs zero reset.	Function changes depending on operation. • Confirms threshold value. • Executes teaching.	Confirms the set condition or value.	

Setting Conditions

Display the target function on the main display and select the desired value from the sub-display to set measurement conditions.

This section uses the example of setting a peak hold as the hold condition to explain how to set measurement conditions.

Changing to FUN and HOLD

1. Set the mode switch to FUN.



2. Use the LEFT and RIGHT Keys to display HOLD on the main display.

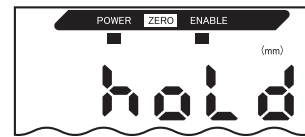

Setting Hold Conditions

3. Press either the UP or DOWN Key.

The present set value will flash on the sub-display.



4. Use the UP and DOWN Keys to select P-H.



Press either the LEFT or RIGHT Key to cancel the selected option. The display will return to the current setting (OFF in this example).



5. When you finish selecting the set value, press the ENT Key to confirm the setting.

The setting will be registered.



Inputting Numerals

This section describes how to input numeric values for threshold and output settings. The example of direct input of the low threshold value will be used.

Changing the low threshold from 0.200 to 0.190

Changing to T Mode

1. Set the mode switch to T.



Setting Threshold Value

2. Set the switch to L.

The measured value will be displayed on the main display. The current setting will be displayed on the sub-display.

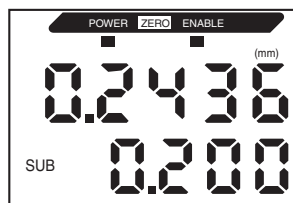

3. Press any Cursor Key.

The first digit on the sub-display will flash and direct input will be enabled.

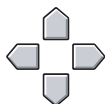

4. Use the LEFT or RIGHT Key to move the cursor to the first decimal place.



5. Use the UP or Down Key to display 1.



6. Repeat steps 4 and 5 to move the cursor to the second decimal place and display 9.

To cancel the selected setting, use the LEFT Key to move the cursor to the leftmost digit and press the LEFT Key again. Alternatively, use the RIGHT Key to move to the rightmost digit and press the RIGHT Key again. The display will return to the current setting (0.200 in this example).



7. When you finish adjusting the numeric value, press the ENT Key to confirm the value.



The display will change from flashing to being lit continuously and the numeric value will be registered.

Function Transition Charts

Reading Transition Charts

The upper section is the main display and the lower section is the sub-display.

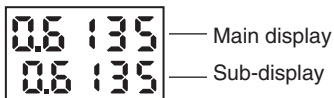

RUN Mode

Measured value (See note.) (The main display always shows the measured value.)

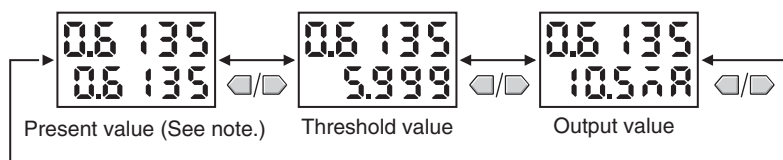

Note: In FUN mode, the measured value and present value are displayed first.

The numerals shown in the above diagram are an example only. The actual display may be different.

Present Values and Measured Values p. 119

T Mode

There is no function transition in T mode.

Measured value

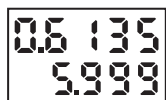

Threshold value

p. 77

The numerals shown in the above diagram are an example only. The actual display may be different.



In RUN and T modes, the position of the threshold switch will determine whether the HIGH or LOW threshold will be displayed.

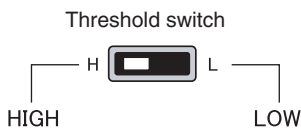

FUN Mode

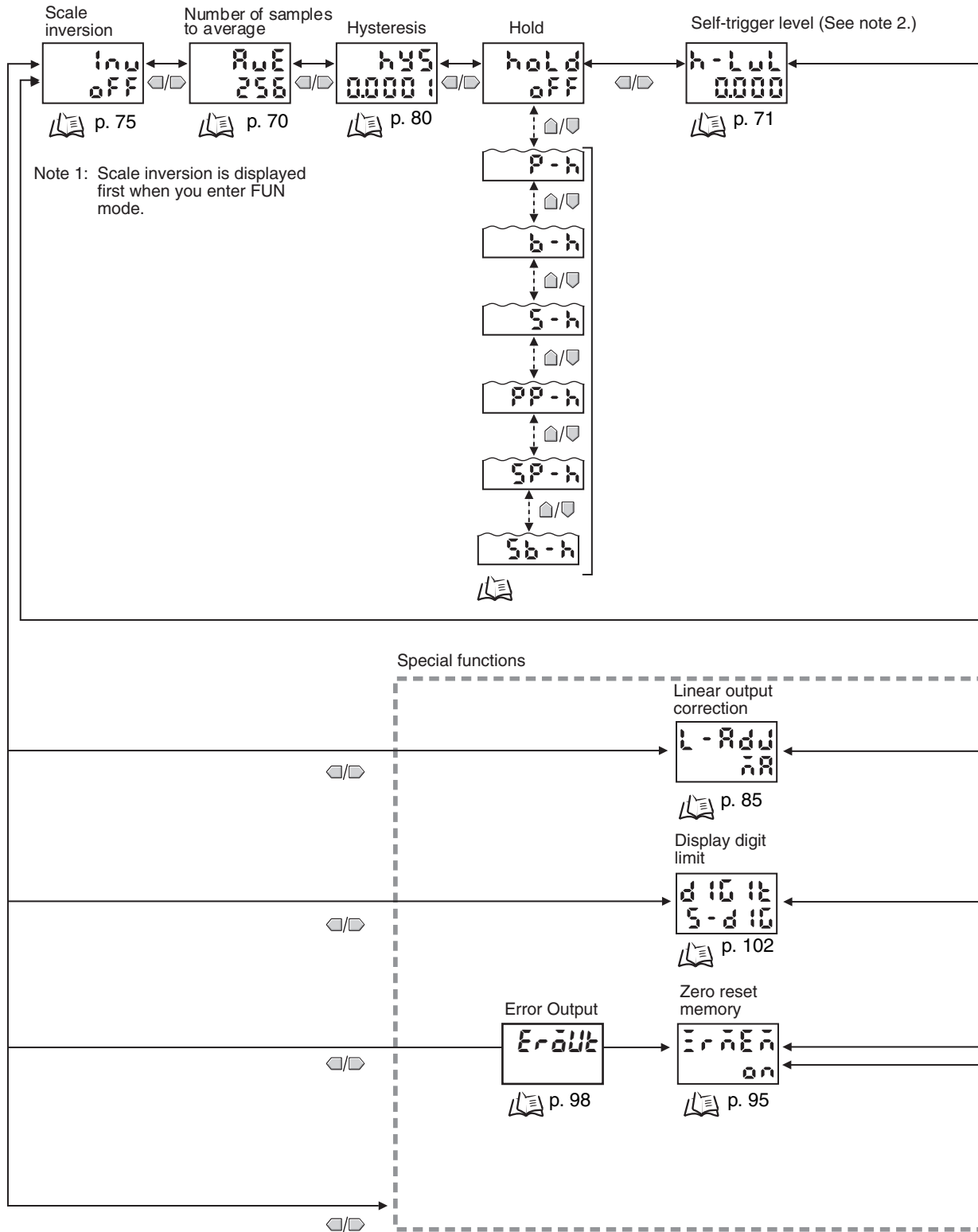

When *RL* is selected, all special functions are displayed.

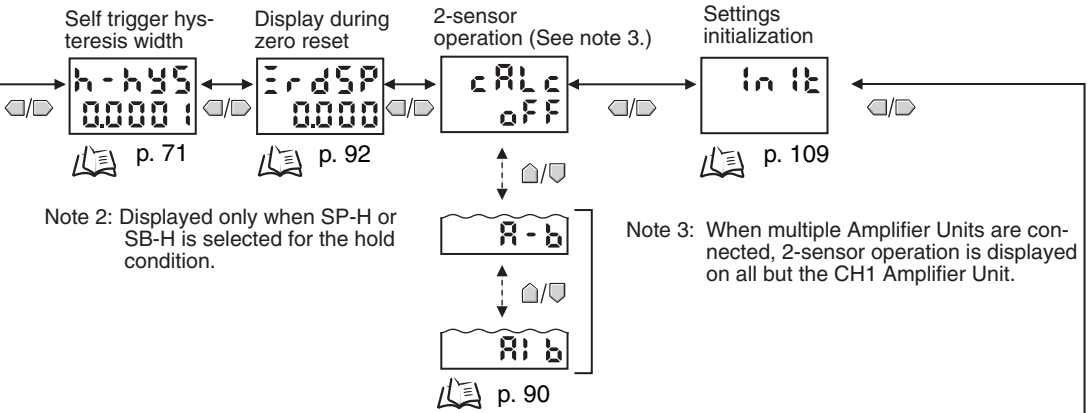

Note 2: Displayed only when SP-H or SB-H is selected for the hold condition.

Note 3: When multiple Amplifier Units are connected, 2-sensor operation is displayed on all but the CH1 Amplifier Unit.

When **clōSE** is selected, the special functions will not be displayed and the display will return to **in u**

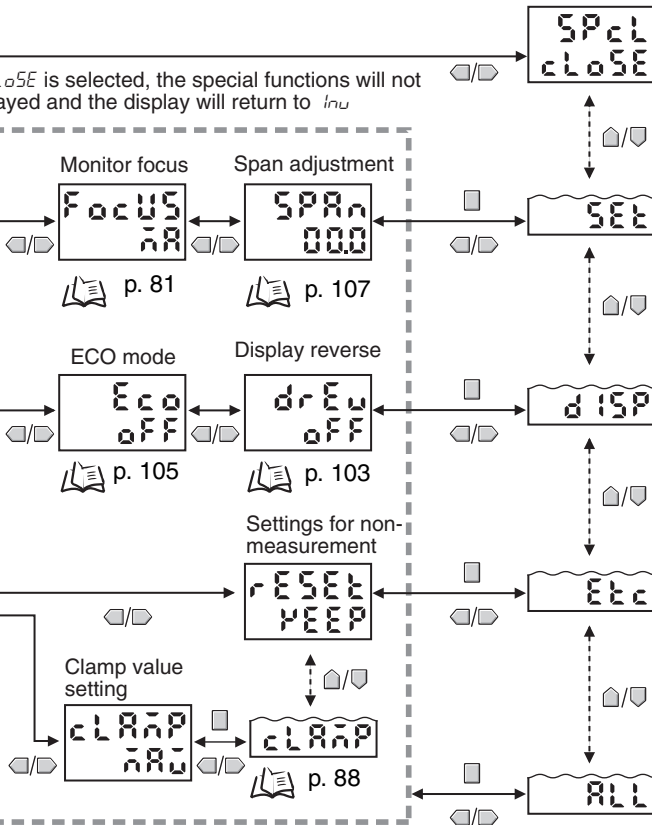

This symbol indicates that after the ENT Key has been pressed to confirm the selection, the LEFT and RIGHT Keys should be pressed to move through the menu.

Section 4

MAIN APPLICATIONS AND SETTING METHODS

☒ Measuring Thickness	52
☒ Measuring the Height of a Step and Flatness	57
☒ Measuring Depth	62
☒ Other Measurements	67

Measuring Thickness

The following configuration will be used to describe the procedure for measuring thickness.

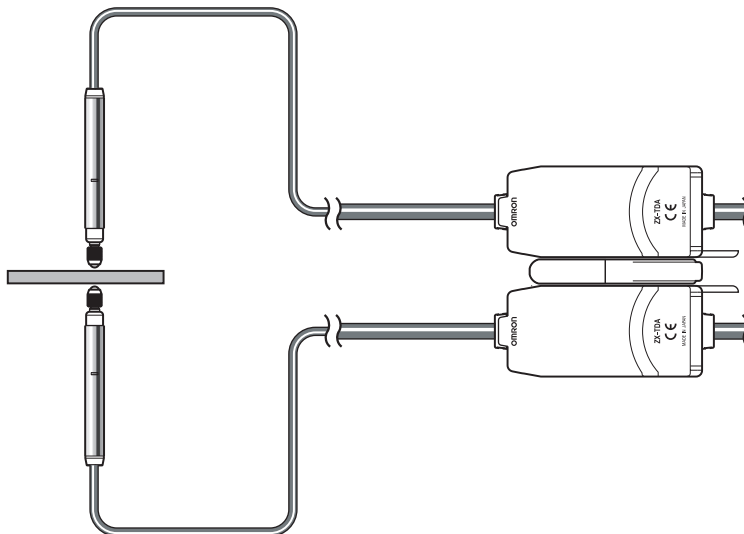

When making settings while still connected to an external device, set the Amplifier Unit's judgement output hold input to ON so that the output to the external device remains unchanged.

■ Flow of Operation



1 Mounting to the Device

■ Connecting Amplifier Units

Connect two Amplifier Units by placing a Calculating Unit between them as shown in the diagram below.

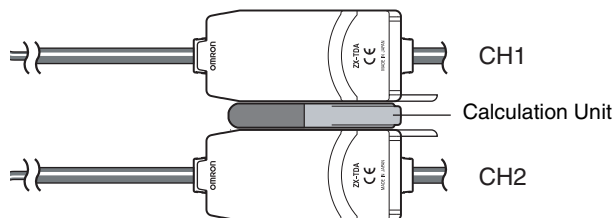

The calculation result is displayed on (i.e. output to) the CH2 Amplifier Unit. Connect the CH2 output cable to the external device to enable external control.

 Connections, p. 30

 The CH1 Amplifier Unit will display (output) the measurement result for the CH1 Sensor Head only.
CHECK!

■ Mounting the Sensor Head to the Inspection Device

Refer to the following diagram and prepare the mounting jigs. Mount the Sensor Heads facing each other.

 Installing Sensor Heads, p. 26

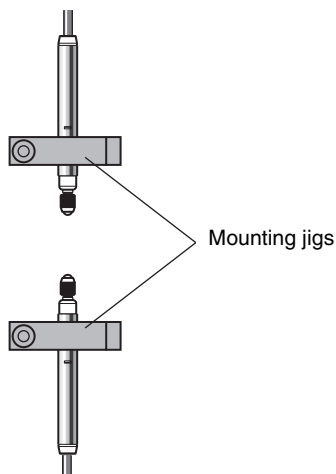

2 Adjusting the Detection Position

Set a reference sample with a known thickness (T) between the Sensor Heads.

With the reference sample in place, adjust the Sensor Heads until the respective Amplifier Units display as close to zero as possible.

 Measurement distance, p. 119

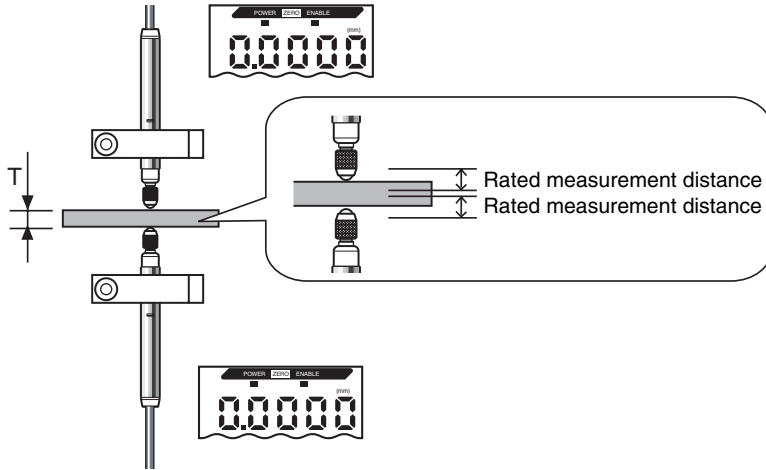

3 Setting Expressions

Switch the CH2 Amplifier Unit to FUN mode and set 2-sensor operation (CALC) to [A + B].

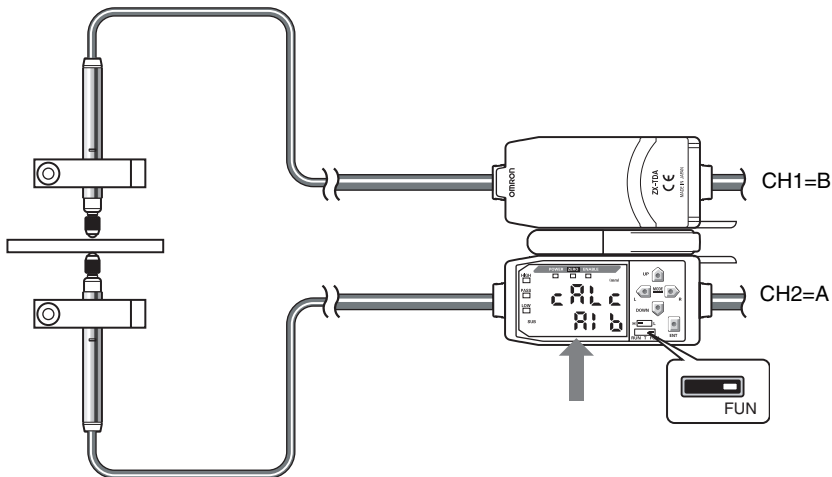

Refer to *Section 5 Detailed Settings* for details on operation.

 Calculating Measured Values, p. 90

4 Setting Thickness Values

Use the Zero Reset Function to set the Sensor Head position for when the reference sample is in place. Use the CH2 Amplifier Unit to perform this setting.

Insert a reference sample with a known thickness (T).

Switch to FUN mode and set the thickness on the Zero Reset display ([ZRDSP]).

Example: T = 1 mm

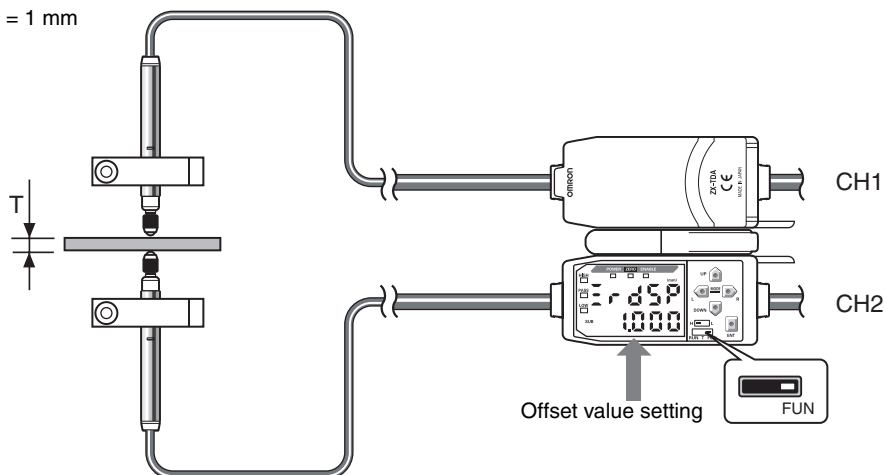

Set the offset value and then return to the RUN mode.

Press and hold the ENT Key for at least 1 s to reset to zero.

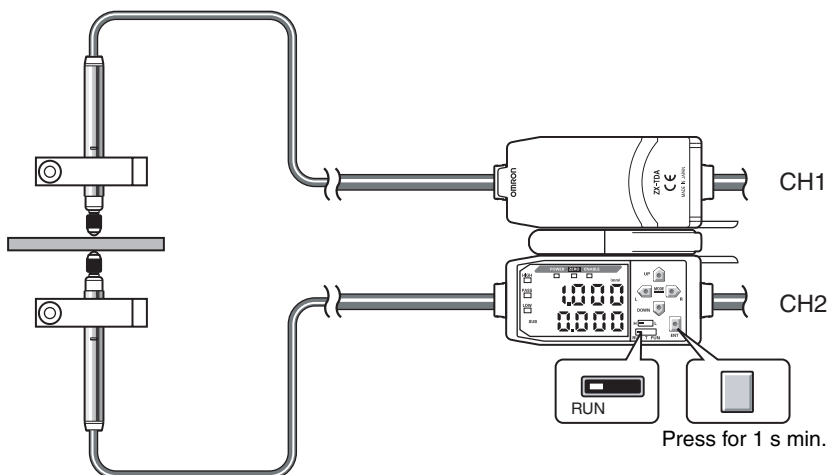

The relationship between the positions of the CH1 and CH2 Sensor Heads will be registered at the same timing that was used when the zero reset was executed. (The display value here is 1 mm.) Thickness is measured based on the relationship of the Sensor Heads, and the measurement result is displayed on the CH2 Amplifier Unit.

Refer to *Section 5 Detailed Settings* for details on operation.



Using the Zero Reset Function, p. 92

5 Setting Tolerance Judgement Values

Set the upper and lower limits (the HIGH and LOW threshold values) for the PASS (OK) judgement on thickness.

The HIGH, PASS, and LOW judgement results will be output based on the threshold values set here.

Measurement result	Judgement
Measurement result > HIGH threshold	HIGH
LOW threshold ≤ Measurement result ≤ HIGH threshold	PASS
LOW threshold > Measurement result	LOW

Refer to *Section 5 Detailed Settings* for details on operation.



Inputting Threshold Values Directly, p. 78

Measuring the Height of a Step and Flatness

The following configuration will be used to describe the procedure for measuring flatness.

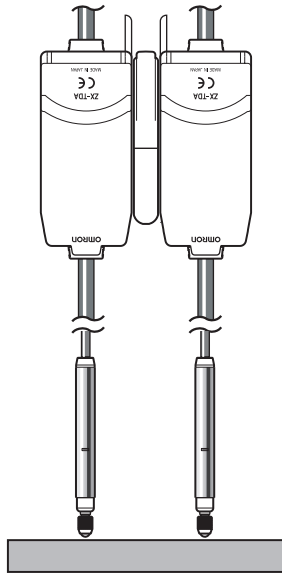

When making settings while still connected to an external device, set the Amplifier Unit's judgement output hold input to ON so that the output to the external device remains unchanged.

■ Flow of Operation

Place an actual sensing object in position. Have a reference sample ready beforehand.

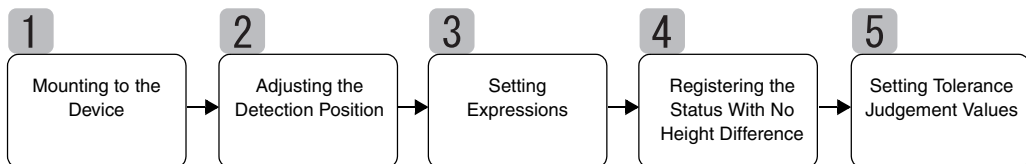

1 Mounting to the Device

■ Connecting Amplifier Units

Connect two Amplifier Units by placing a Calculating Unit between them as shown in the diagram below.

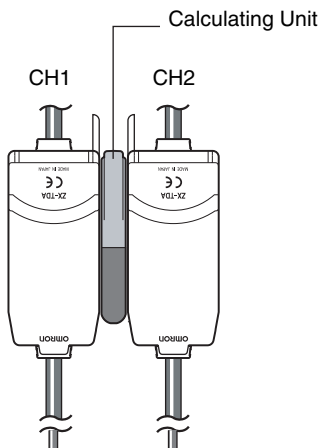

The calculation result is displayed on (i.e. output to) the CH2 Amplifier Unit. Connect the CH2 output cable to the external device to enable external control.



Connections, p. 30



CHECK!

The CH1 Amplifier Unit will display (output) the measurement result for the CH1 Sensor Head only.

■ Mounting Sensor Heads to the Inspection Device

Refer to the following diagram and prepare mounting jigs. Mount the Sensor Heads parallel to each other.



Installing Sensor Heads, p. 26

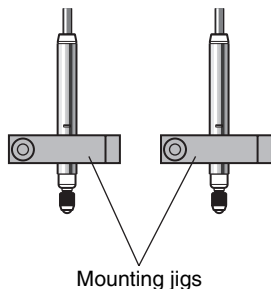

2 Adjusting the Detection Position

Set a flat reference sample between the Sensor Heads.

With the reference sample in place, adjust the Sensor Heads until the respective Amplifier Units display as close to zero as possible.

 Measurement distance, p. 119

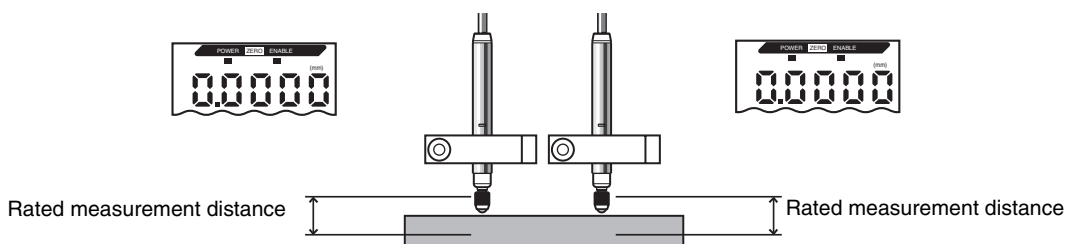

3 Setting Expressions

Switch the CH2 Amplifier Unit to FUN mode and set 2-sensor operation (CALC) to [A - B].

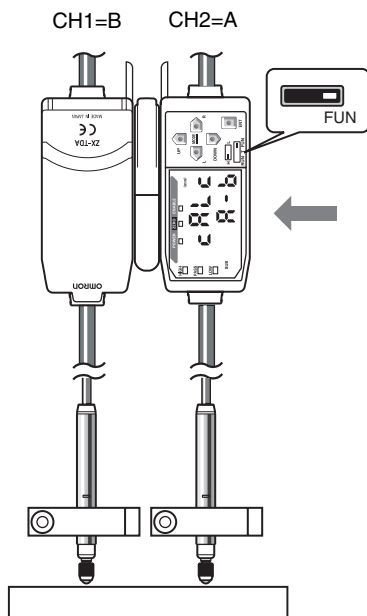

Refer to *Section 5 Detailed Settings* for details on operation.

 Calculating Measured Values, p. 90

4 Registering the Status With No Height Difference

Use the Zero Reset Function to set the status with no height difference. Use the CH2 Amplifier Unit to perform this setting.

Set a flat reference sample under the Sensor Heads.



Check to see if the zero reset offset value (ZRDSP) on the CH2 Amplifier Unit is set to zero before you reset to zero. (Zero is the default setting.)

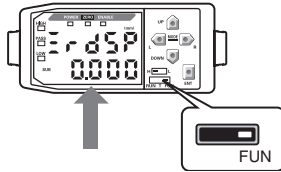

 Setting Offset Values, p. 94

Switch the CH2 Amplifier Unit to RUN mode, and press and hold the ENT Key for at least 1 s to reset to zero.

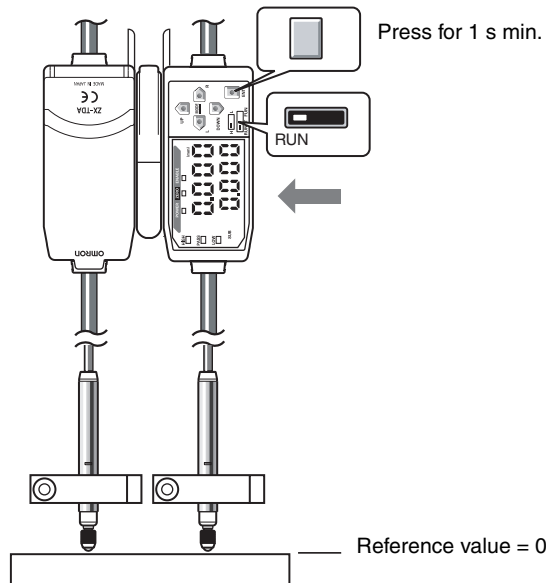

The status with no height difference (0) will be registered at the same timing that was used when the zero reset was executed. Now the CH2 Amplifier Unit will display height differences between the sensing points.

Refer to *Section 5 Detailed Settings* for details on operation.

 Using the Zero Reset Function, p. 92

5 Setting Tolerance Judgement Values

Set the upper and lower limits (the HIGH and LOW threshold values) for the PASS (OK) judgement on height difference/flatness.

The HIGH, PASS, and LOW judgement results will be output based on the threshold values set here.

Measurement result	Judgement
Measurement result > HIGH threshold	HIGH
LOW threshold ≤ measurement result ≤ HIGH threshold	PASS
LOW threshold > measurement result	LOW

Refer to *Section 5 Detailed Settings* for details on operation.



Inputting Threshold Values Directly, p. 78

Measuring Depth

The following configuration will be used to describe the procedure for measuring depth.

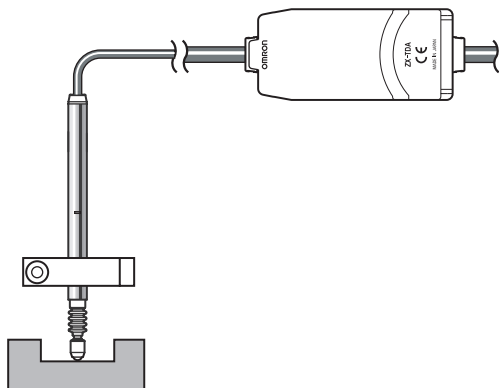

When making settings while still connected to an external device, set the Amplifier Unit's judgement output hold input to ON so that the output to the external device remains unchanged.

CHECK!

■ Flow of Operation

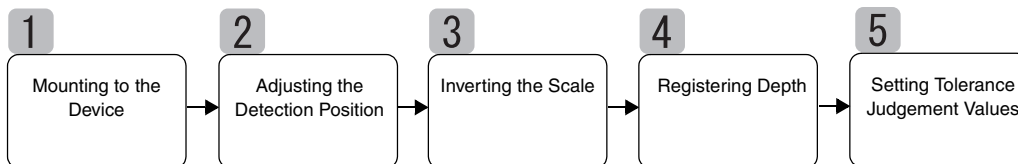

1 Mounting to the Device

Prepare the mounting jig and mount the Sensor Head.

 Installing Sensor Heads, p. 26

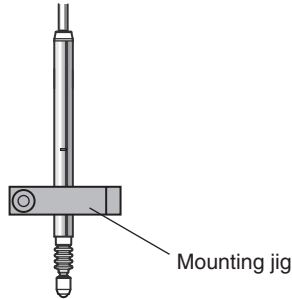

2 Adjusting the Detection Position

Set a reference sample with a known depth (D) under the Sensor Head.

With the reference sample in place, adjust the Sensor Head until the Amplifier Unit displays as close to zero as possible.

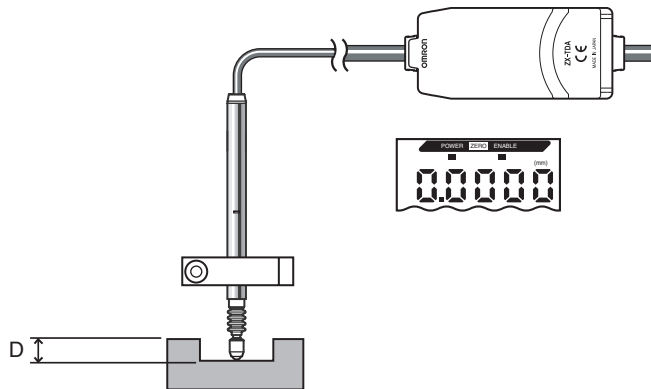

3 Inverting the Scale

Switch ON the Scale Inversion Function (INV) to match changes in sensing object displacement to changes in the measured value on the display. (OFF is the default setting.)

For the default setting (OFF), the display value increases when the Sensor Head plunger is pressed. If a measurement is taken with this setting, the display value will increase as the sensing object becomes thinner.

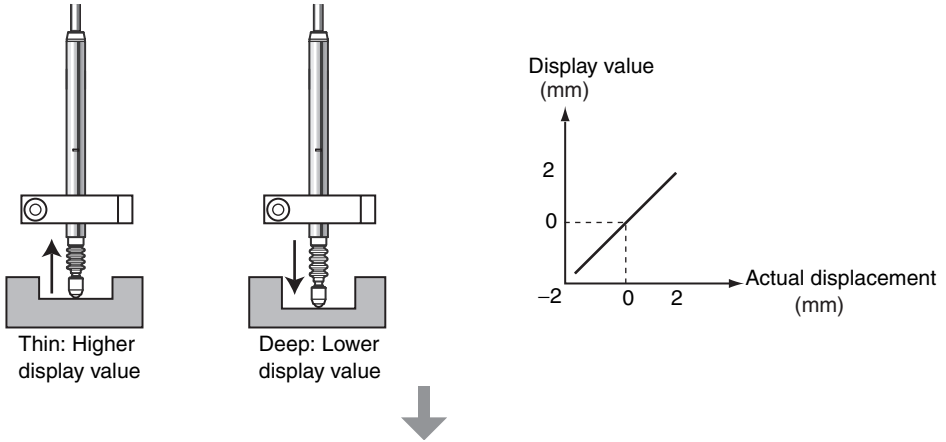

Changes are inverted if the Scale Inversion Function (INV) is set to ON. This means that changes in the amount of displacement can be matched to changes in display values.

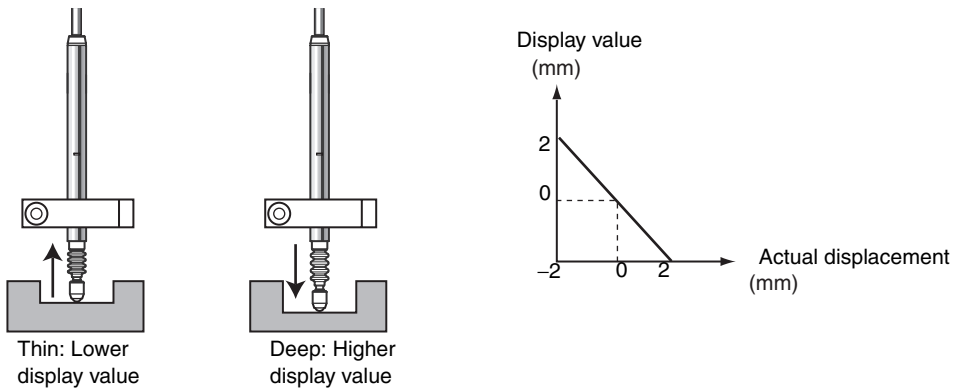

Refer to *Section 5 Detailed Settings* for details on operation.



Inverting Positive and Negative Values (Scale Inversion), p. 75

4 Registering Depth

Use the zero reset function to register the Sensor Head position at the reference depth. Set a reference sample with a known depth (D) under the Sensor Head.

Switch to FUN mode and set the depth on the Zero Reset display ([ZRDSP]).

Example: D = 3 mm

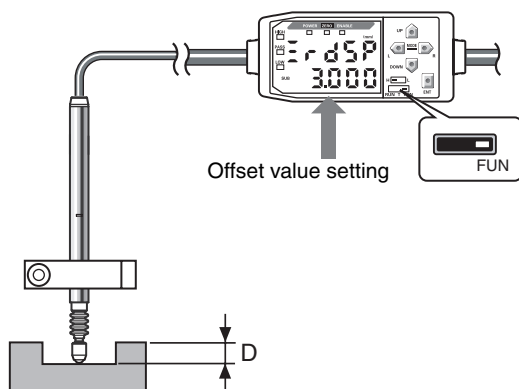

Set the offset value and then return to the RUN mode.

Press and hold the ENT Key for at least 1 s to reset to zero.

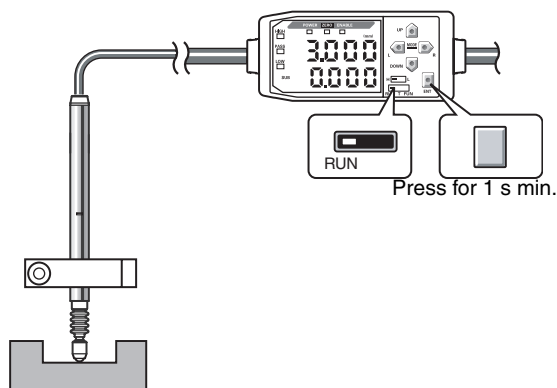

The Sensor Head position will be registered at the same timing that was used when the zero reset was executed. (The display value here is 3 mm.) Depth is measured based on this positional relationship of the Sensor Head.

Refer to *Section 5 Detailed Settings* for details on operation.



Using the Zero Reset Function, p. 92

5 Setting Tolerance Judgement Values

Set the upper and lower limits (the HIGH and LOW threshold values) for the PASS (OK) judgement on depth.

Measurement result	Judgement
Measurement result > HIGH threshold	HIGH
LOW threshold \leq Measurement result \leq HIGH threshold	PASS
LOW threshold > Measurement result	LOW

Refer to *Section 5 Detailed Settings* for details on settings.



Inputting Threshold Values Directly, p. 78

Other Measurements

Measuring Gaps in Sensing Objects

Gaps (G) in sensing objects can be measured using the thickness measurement.



The procedure is the same one used to measure thickness.



Measuring Thickness, p. 52

■ Gap Measurement Basics

■ Using the Scale Inversion Function

Switch ON the Scale Inversion Function (INV) on the Amplifier Units to match changes in gap size to changes in measured values on the display. (Inversion is turned OFF in the default setting.)

For the default setting (OFF), the display value increases when the Sensor Head plunger is pressed. If a measurement is taken with this setting, the display value will increase as the gap size decreases.

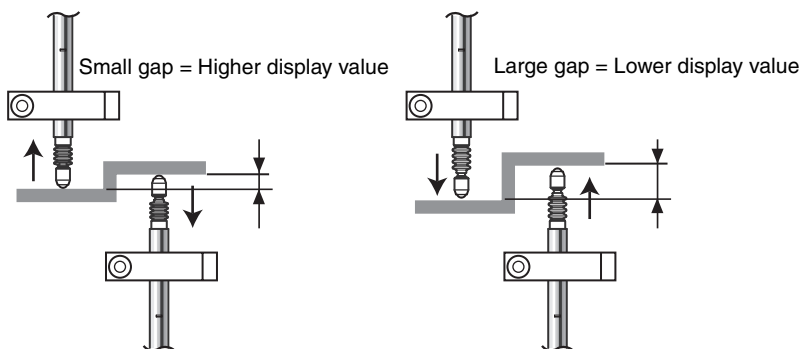

Changes are inverted if the Scale Inversion Function (INV) is set to ON. This means that changes in the amount of displacement can be matched to changes in display values.

■ Setting the Gap (G) on the Zero Reset Display (ZRDSP)

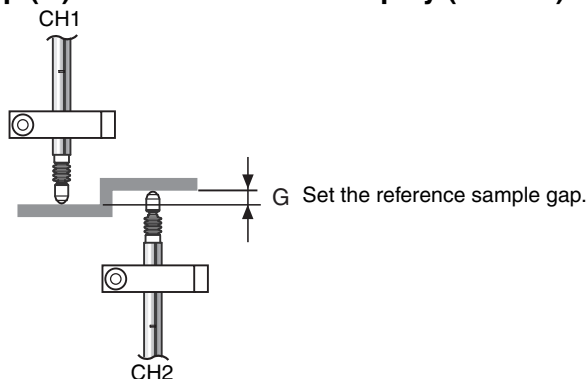

Measuring Height Differences at Multiple Points

If Calculating Units are used to connect Amplifier Units, then up to 8 calculation points can be measured simultaneously.

The procedure is the same one used to measure height difference/flatness.

Set all Amplifier Units starting from the CH2 to the same CH2 settings used to measure height difference and flatness.

 Measuring the Height of a Step and Flatness, p. 57

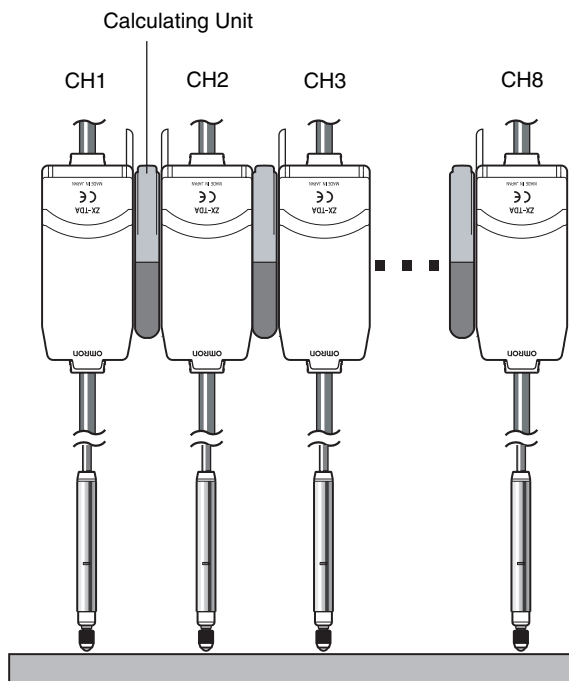

Display on Amplifier Units starting at CH2

The difference between displacement at CH1 and at each of the other channels is displayed.

Example:

For the following present values: The following measured values are displayed:

CH1: 0.2 mm

CH1: 0.2 mm

CH2: 0.3 mm

CH2: 0.1 mm (CH2-CH1)





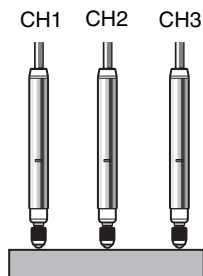



CH3: -0.4 mm

CH3: -0.6 mm (CH3-CH1)



Section 5

DETAILED SETTINGS

 Setting Number of Samples to Average	70
 Using Hold Functions	71
 Inverting Positive and Negative Values (Scale Inversion)	75
 Entering Threshold Values	77
 Linear Output	81
 Calculating Measured Values	90
 Using the Zero Reset Function	92
 Error Output Function	98

Setting Number of Samples to Average

The number of samples to average is the number of data points used to average data measured by the Sensor. The average value will be output.

Use the number of samples to average function to ignore sudden variations in measured values. If the number of samples is increased, however, the response time of the judgement outputs and linear output will be increased.

Selection for No. of samples to average	Response time
1	2 ms
2	3 ms
4	5 ms
8	9 ms
16	17 ms
32	33 ms
64	65 ms
128	129 ms
256 (default)	257 ms
512	513 ms
1024	1025 ms

Moving to FUN and AVE

1. Set the mode switch to FUN.



2. Use the LEFT and RIGHT Keys to display AVE on the main display.

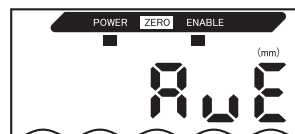

Selecting Number of Samples to Average

3. Press the UP or DOWN Key.
The sub-display will flash.



4. Use the UP and DOWN Keys to select the number of samples to average.



5. Press the ENT Key to confirm the selection.



The setting will be registered.



Using Hold Functions

The hold functions hold data for specific points during the measurement period (sampling period), such as the maximum or minimum value, and output those values at the end of the measurement period.

The value that will be held during the sampling period is selected here.

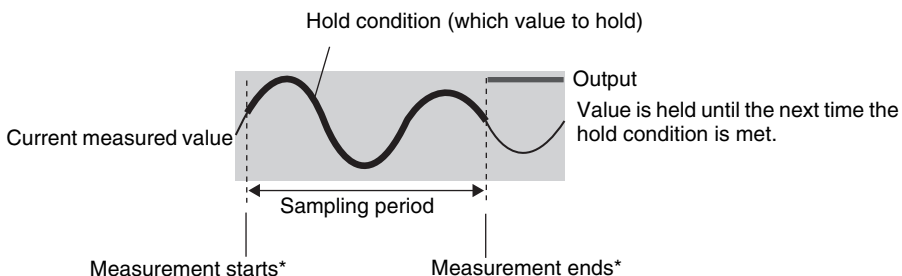

* The timing input method depends on the hold conditions.



The CLAMP value is output until the first sampling period is finished.
CLAMP value, p. 88

Selection	Details
OFF (default)	Hold measurement is not performed. The current measured value is always output.
P-H (Peak hold)	<p>Holds the maximum value during the sampling period. The sampling period is the period that the timing signal is ON.</p> <p>Timing input ON OFF</p>
B-H (Bottom hold)	<p>Holds the minimum value during the sampling period. The sampling period is the period that the timing signal is ON.</p> <p>Timing input ON OFF</p>

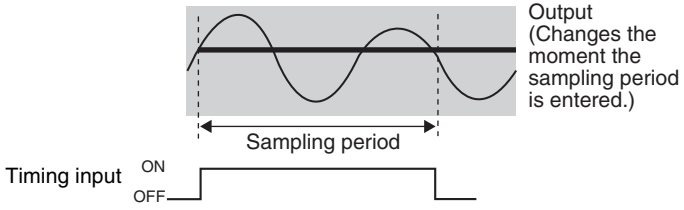
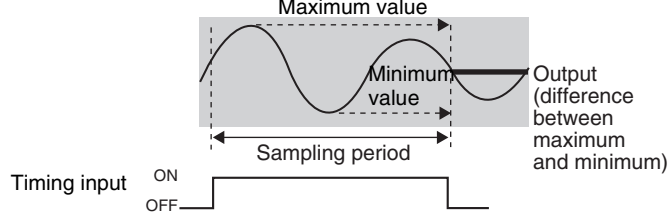
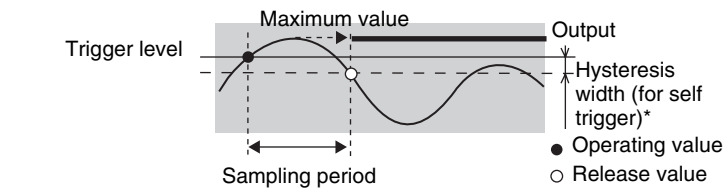
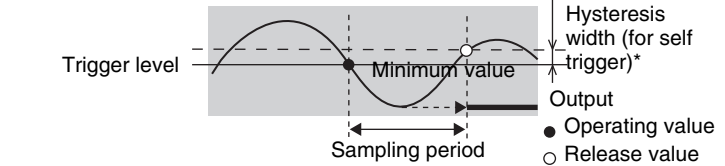
Selection	Details
S-H (Sample hold)	<p>Holds the measured value the moment the timing signal turns ON.</p>  <p>Output (Changes the moment the sampling period is entered.)</p> <p>Timing input ON OFF</p> <p>Sampling period</p>
PP-H (Peak-to-peak hold)	<p>Holds the difference between the maximum and minimum values during the sampling period. The sampling period is the period that the timing signal is ON. This option is selected mainly when detecting vibration.</p>  <p>Maximum value</p> <p>Minimum value</p> <p>Output (difference between maximum and minimum)</p> <p>Timing input ON OFF</p> <p>Sampling period</p>
SP-H (Self-peak hold)	<p>Holds the maximum value during the sampling period. The sampling period is the period when the measured value is greater than the specified trigger level.</p>  <p>Maximum value</p> <p>Trigger level</p> <p>Output</p> <p>Hysteresis width (for self trigger)*</p> <p>● Operating value</p> <p>○ Release value</p> <p>Sampling period</p>
SB-H (Self-bottom hold)	<p>Holds the minimum value during the sampling period. The sampling period is the period when the measured value is lower than the specified trigger level.</p>  <p>Minimum value</p> <p>Trigger level</p> <p>Output</p> <p>Hysteresis width (for self trigger)*</p> <p>● Operating value</p> <p>○ Release value</p> <p>Sampling period</p>



Hysteresis width (for self trigger)

Set the hysteresis based on fluctuations in the measured values around the trigger level. When set, hysteresis will be applied from the start of the sampling period and will prevent timing input chattering.

Moving to FUN and HOLD

1. Set the mode switch to FUN.



2. Use the LEFT and RIGHT Keys to display HOLD on the main display.

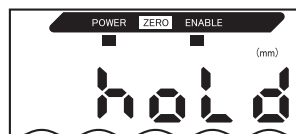

Selecting Hold Condition

3. Press the UP or DOWN Key.

The sub-display will flash.



4. Use the UP and DOWN Keys to select the hold condition.



5. Press the ENT Key to confirm the selection.

The setting will be registered.



The following settings are performed only if SP-H or SB-H is the selected hold condition.

Setting Trigger Levels

6. Use the RIGHT or LEFT Key to display H-LVL on the main display.

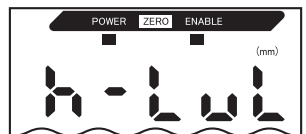

7. Press the UP or DOWN Key.

The leftmost digit of the sub-display will flash.



8. Use the Cursor Keys to set the trigger level.



---- Move between digits.



---- Increment and decrement the numeric value.

Section 5 DETAILED SETTINGS

- 9.** Press the ENT Key to confirm the settings.

The trigger level will be registered.



Setting Hysteresis Width (for Self Trigger)

- 10.** Use the LEFT and RIGHT Keys to display H-HYS on the main display.

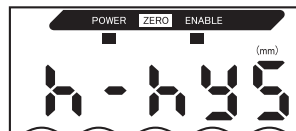

- 11.** Press the UP or DOWN Key.

The leftmost digit of the sub-display will flash.



- 12.** Use the Cursor Keys to set the hysteresis width for the trigger level.



--- Move between digits.



--- Increment and decrement the numeric value.

- 13.** Press the ENT Key to confirm the setting.

The hysteresis width (for self trigger) will be registered.



Inverting Positive and Negative Values (Scale Inversion)

This function changes the amount that the measured value on the display changes as the amount of displacement changes. For the default setting, the display value increases when the Sensor Head plunger is pressed.

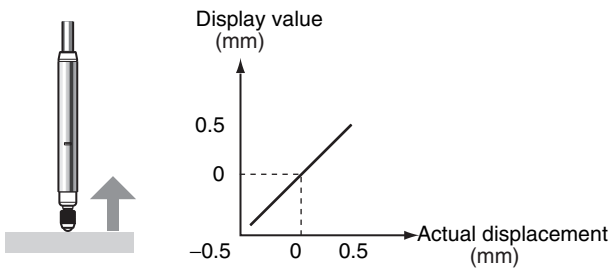
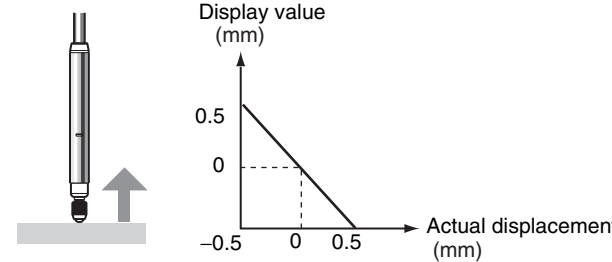
Options	Description
OFF (default)	<p>The display value increases when the plunger is pressed.</p>  <p>The graph shows 'Display value (mm)' on the y-axis and 'Actual displacement (mm)' on the x-axis. The y-axis has markers at -0.5, 0, and 0.5. The x-axis has markers at -0.5, 0, and 0.5. A solid line starts at (-0.5, -0.5) and goes up to (0.5, 0.5), passing through the origin (0,0). A dashed line connects the origin to the axes.</p>
ON	<p>The display value decreases when the plunger is pressed.</p>  <p>The graph shows 'Display value (mm)' on the y-axis and 'Actual displacement (mm)' on the x-axis. The y-axis has markers at -0.5, 0, and 0.5. The x-axis has markers at -0.5, 0, and 0.5. A solid line starts at (-0.5, 0.5) and goes down to (0.5, -0.5), passing through the origin (0,0). A dashed line connects the origin to the axes.</p>

Moving to FUN and INV

1. Set the mode switch to FUN.



2. Use the LEFT and RIGHT Keys to display INV on the main display.

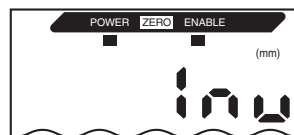

Selecting the Display

3. Press the UP or DOWN Key.

The sub-display will flash.



4. Select the display.



5. Press the ENT Key to confirm the setting.

The setting is registered.



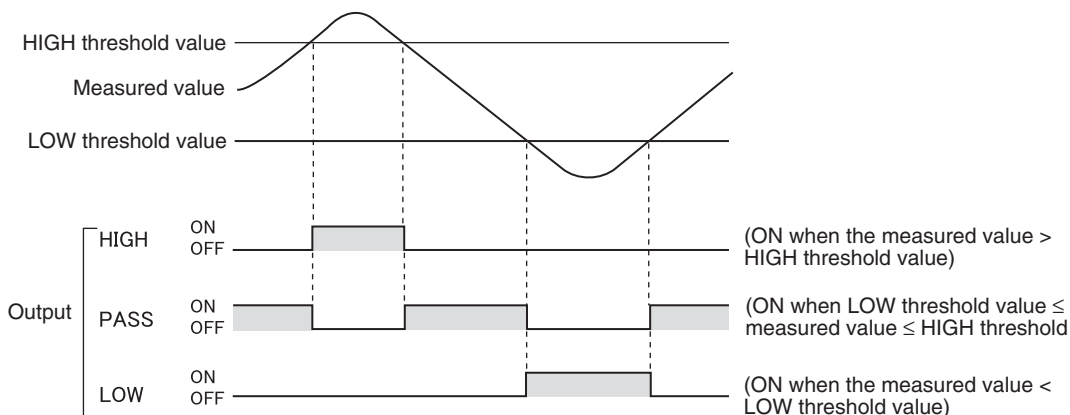

Entering Threshold Values

Threshold values are set to determine the range for PASS judgements. Both HIGH and LOW threshold values are set. There are three judgement outputs: HIGH, PASS, and LOW.



The following table outlines the two methods for setting the threshold values.

Method	Details
Direct input	Sets threshold values by direct numerical value input. Direct input is useful when you know the dimensions for an OK judgement or when you want to fine-tune threshold values after teaching.
Position teaching	Performs actual measurements and uses the measurement results to set threshold values. Position teaching is useful when threshold samples, i.e., with the upper and lower limits, can be obtained beforehand.

 Hysteresis (hysteresis width) can also be set for threshold values. Set hysteresis when judgements are unstable to prevent chattering.  p. 80
CHECK!

 When making settings while still connected to an external device, set the Amplifier Unit judgement's output hold input to ON so that the output to the external device remains unchanged. The judgement outputs in T mode will be the same as in RUN mode, i.e., HIGH, PASS, and LOW.
CHECK!

Inputting Threshold Values Directly

The threshold values can be set by directly inputting the numeric values.

Direct input is useful when the dimensions for an OK judgement are known beforehand or when fine-tuning threshold values after teaching.

Moving to T Mode

1. Set the mode switch to T.



Setting Threshold Values

2. Move the threshold switch to either H or L, i.e., the threshold to be set.

The current measured value is shown on the main display and the threshold being set (value for the threshold switch selection) will be displayed on the sub-display.

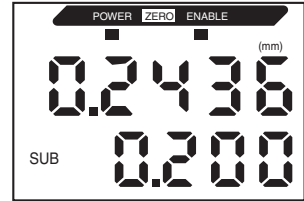

3. Press one of the Cursor Keys.

The leftmost digit of the threshold value will flash on the sub-display.

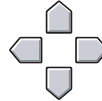

4. Use the Cursor Keys to set the threshold value.



--- Move between digits.



--- Increment and decrement the numeric value.

5. Press the ENT Key to confirm the settings.

The threshold values will be registered.



Countermeasures for Setting Errors

One of the following two errors has occurred if the display reads ERRHL or ERRHL.

HIGH threshold value < LOW threshold value

HIGH threshold value – LOW threshold value < hysteresis width



Hysteresis Setting, p. 80



If an error is displayed, the threshold value has not been updated. Set the threshold values again.

Position Teaching

When teaching is executed, measurement is performed and the measured values are set as the threshold values.

Position teaching is useful when threshold samples, i.e., with the upper and lower limits, can be obtained beforehand.

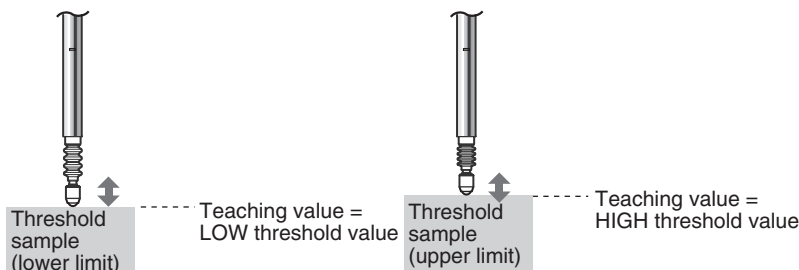

CHECK!

Hold, zero reset, and scale inversion settings that have been made before teaching are reflected in the teaching measurements.

Moving to T Mode

1. Set the mode switch to T.



Setting Threshold Values

2. Move the threshold switch to either H or L, i.e., the threshold to be set.



The current measured value is shown on the main display and the threshold being set (the value for the threshold switch selection) will be displayed on the sub-display.

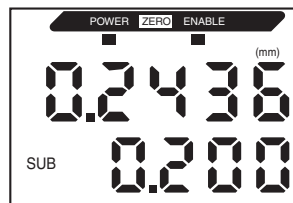

3. Place the threshold sample in position.

The main display value changes.

4. Press the ENT Key for at least one second and then release.



The measured value at the point that the ENT Key is released will be set as the threshold value. This threshold value will be shown on the sub-display.



When ERR LH or ERR HL Is Displayed: p. 78



CHECK!

The threshold values set using position teaching can be changed using direct input. This is useful when setting judgement tolerances for measured values.



p. 78

Hysteresis Setting

Set the hysteresis width for the upper and lower limits of judgements when the HIGH, PASS, or LOW judgements are unstable near the threshold values

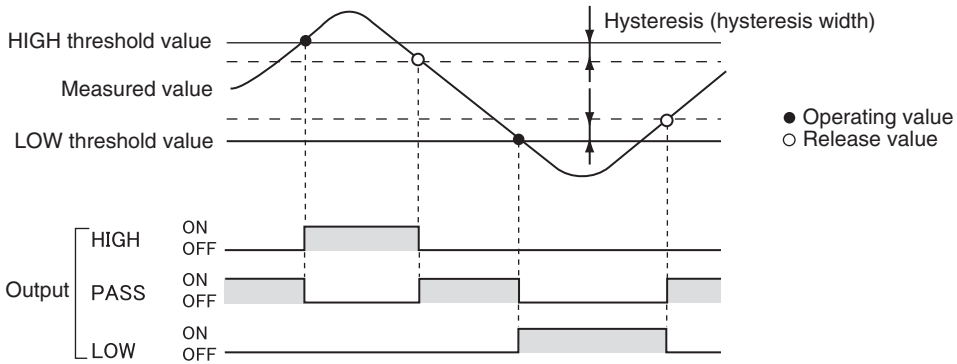

To prevent self-trigger chattering, set hysteresis for the self-trigger.



p. 71

CHECK!

Moving to FUN and HYS

1. Set the mode switch to FUN.
2. The main display will show HYS.
3. Press the UP or DOWN Key.
The leftmost of the sub-display will flash.
4. Use the Cursor Keys to enter the hysteresis width.)
5. Press the ENT Key to confirm the setting.
The hysteresis width will be registered.

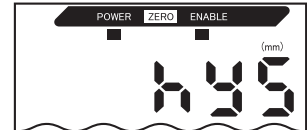
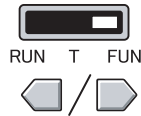

Move between digits.



Increment and decrement the numeric value.



Countermeasures for Setting Errors

If ERROV is displayed, HIGH threshold value – LOW threshold value < hysteresis width.

If an error is displayed, the threshold values have not been updated. Set the values again or change the threshold values.



Linear Output

Output Settings (Monitor Focus)

Linear output refers to the conversion of measurement results to a 3 to 21-mA current output or a -5 to 5-V voltage output. This section describes how to choose either current or voltage output and how to set the linear output range. Match the settings to suit the connected external device.

Enter the output values for any two current values or voltage values to set the output range.

When a Sensor Head with a model number with a "T" suffix is connected, the measured value of the output cannot be changed. Only the current output or voltage output can be changed.

Example:

Setting -0.5 mm to a 16-mA output and 0.5 mm to a 8-mA output (for current output)

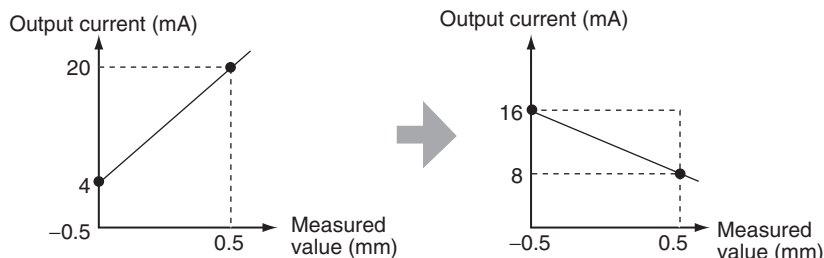

Separate the two specified points by at least 1% of the rated measurement distance for the connected Sensor.

CHECK!

For example, the rated measurement distance for the ZX-TSD01T Sensor is 1 mm. Therefore, the two specified points must be separated by 10 μm min.



Using the Zero Reset Function

Zero reset is released when monitor focus is set. Execute the zero reset again after setting monitor focus.

CHECK!

 Zero Reset, p. 92

Section 5 DETAILED SETTINGS

This section describes how to set the output range, using an example of current output with a range with the following conversions: -0.5 mm to 16 mA and 0.5 mm to 8 mA . Change the values in the example to suit the voltage output as required.

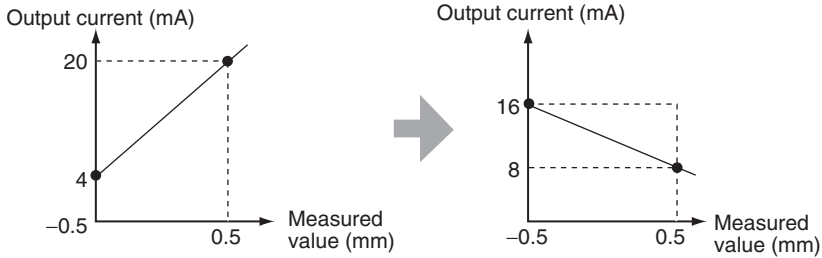

1. Turn OFF the power supply to the Amplifier Unit.
2. Move the current/voltage switch to current output. The switch is found on the bottom of the Amplifier Unit.

A voltage output is the default setting.

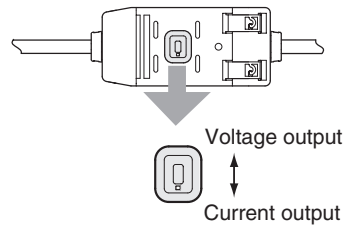

Moving to FUN and SPCL

3. Turn ON the power supply and move the mode switch to FUN.
4. Use the LEFT and RIGHT Keys to display SPCL on the main display.

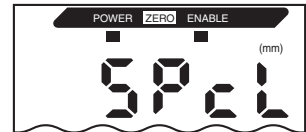

Moving to FOCUS

5. Press the UP or DOWN Key.
The sub-display will flash.
6. Use the Up and DOWN Keys to display SET or ALL.
7. Press the ENT Key.



8. Use the LEFT and RIGHT Keys to display FOCUS on the main display.

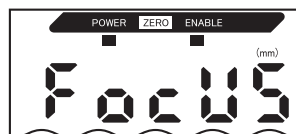

Selecting Current (mA) or Voltage (V) Output

9. Press the UP or DOWN Key.



The sub-display will flash.

10. Display mA.



Always select the same output as the current/voltage switch selection on the bottom of the Amplifier Unit.

CHECK!

Setting the First Point (A)

11. Press the ENT Key.



The display will change to allow the first-point settings to be made. The output current value will be displayed on the main display, and the corresponding measured value will be displayed on the sub-display and the leftmost digit will flash.

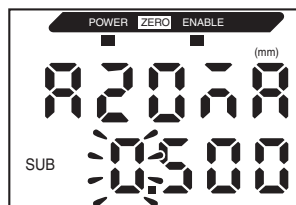

12. Set the output current value and the corresponding measured value for the first point.



----- Move between digits.

Set a measured value within the measurement distance. If scaling or calculation has been set, set a value that reflects those settings.



----- Increment and decrement the numeric value.



The flashing digit, i.e., the digit for which a value can be set, will change as shown in the diagram.

CHECK!

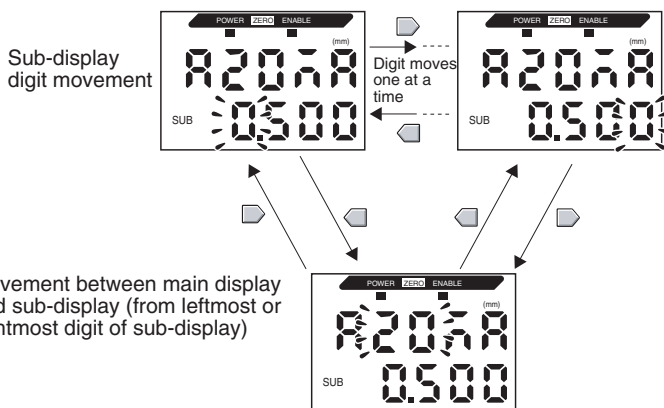

13. Press the ENT Key to confirm the setting.

The setting for the first point will be confirmed. The screen for setting the second point will then be displayed.

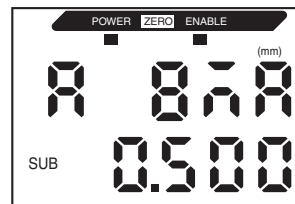

Setting the Second Point (B)

14. Use the same procedure as for the first point to set the output current value and corresponding measurement result for the second point.

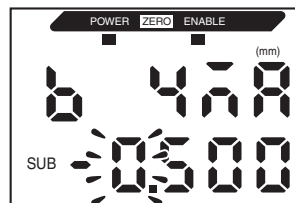

15. Press the ENT Key to confirm the settings.

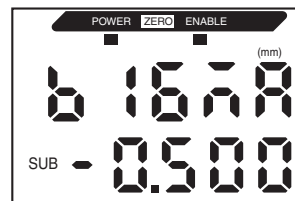

Confirming Completion of Monitor Focus Settings

The display will read OK if monitor focus has been set correctly.

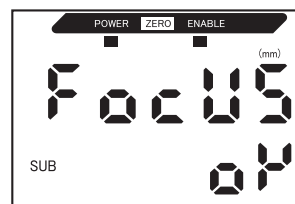

The display will be NG if the settings are incorrect.

If the settings are incorrect, check the following points and execute the monitor focus again.

- Is the measured value set on the sub-display within the measurement distance (with scaling and calculation settings reflected if set)?
- Are the first and second points separated by at least 1% of the rated measurement distance?
- Are the current (or voltage) values for the two points the same?

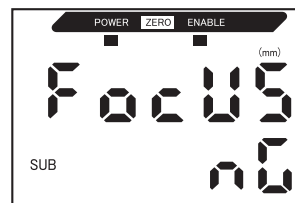

Correcting Linear Output Values

Discrepancies may occur between the linear output current (or voltage) values set on the Amplifier Unit and the actual current (or voltage) values measured due to the conditions for the connected external device or other factors. The linear output correction function can be used to correct this discrepancy.

The output values are corrected by entering the correction value for the current or voltage values for any two points.



CHECK!

Set the monitor focus function and select either current or voltage output beforehand.



p. 81

This section uses a current output as an example. Change the values in this example for voltage output as necessary.

1. Connect the linear output to an external ammeter.

Moving to FUN and SPCL

2. Turn ON the power supply and set the mode switch to FUN.



3. Use the LEFT and RIGHT Keys to display SPCL on the main display.

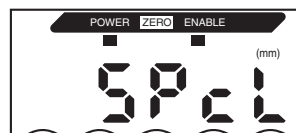

Moving to LEFT-ADJ

4. Press the UP or DOWN Key.

The sub-display will flash.



5. Use the UP or DOWN Keys to display SET or ALL.



Section 5 DETAILED SETTINGS

- 6.** Press the ENT Key.



- 7.** Use the LEFT and RIGHT Keys to display L-ADJ on the main display.

The units for the monitor focus settings (mA or V) will be shown on the sub-display.

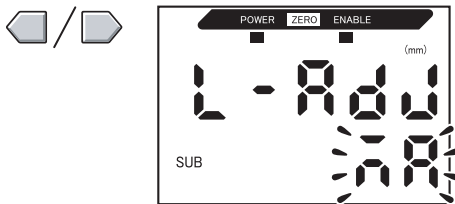

- 8.** Press the ENT Key.

The display will change to the settings for the first point (A). The output current value will be displayed on the main display and the correction will be displayed on the sub-display and the leftmost digit will flash.

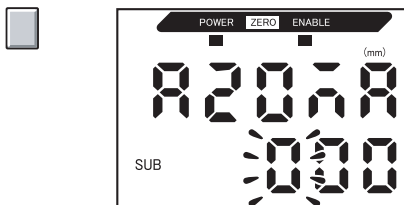

Setting the First Point (A)

- 9.** Set the output current and correction values for the first point.

Adjust the correction value on the sub-display so that the ammeter reading and the output current shown on the main display are the same. The larger the correction value, the larger the output current.

The correction value can be set within the range -999 to 999. To set a negative value, make the leftmost digit of the sub-display flash and change the value.

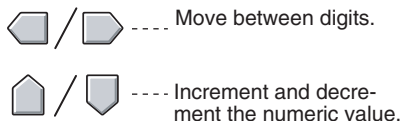

The flashing digit, i.e., the digit for which a value can be set, will change as shown in the diagram.

CHECK!

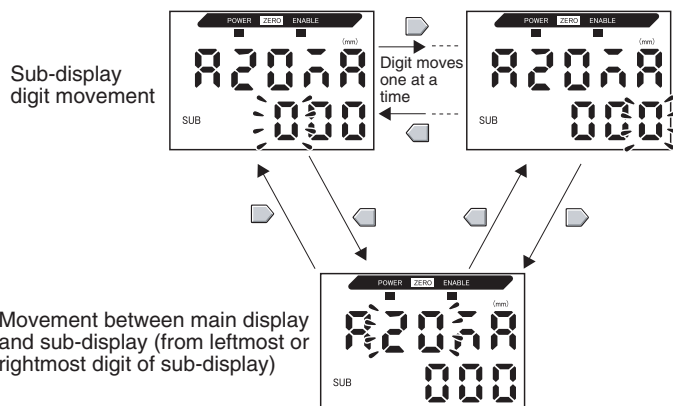

- 10.** Press the ENT Key to confirm the settings.

The correction value for the first point will be confirmed.

The screen for setting the second point correction value will be displayed.

Setting the Second Point (B)

11. Use the same procedure as the first point to set the correction value for the second point.

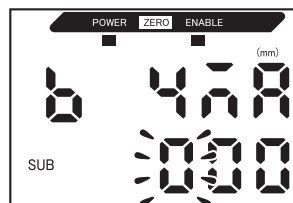

12. Press the ENT Key.



Confirming Setting Results

If linear output correction has been registered correctly, the sub-display will show OK.

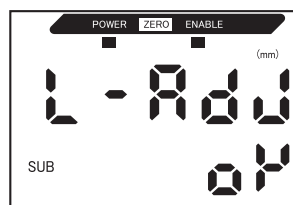

If the correction is not registered correctly, the display will show NG.

Check that the current (or voltage) value for the two points are not the same and execute again.

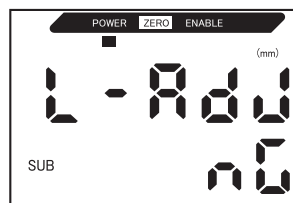

Output Settings for Non-measurement

The linear output method for when a reset is input can be set.

Selection	Outputs	
	Judgement outputs	Linear output
KEEP (default)	The status immediately before measurement is stopped is held and output.	
CLAMP	All OFF.	Outputs the set CLAMP value. The following options are available. <ul style="list-style-type: none"> • For current output: 3 to 21 mA or maximum (approx. 23 mA) • For voltage output: -5 to 5 V or maximum (approx. 5.5 V)



For Hold Measurements
Even if KEEP is set, the output before the first hold value is obtained will be the same as CLAMP.

Moving to FUN and SPCL

1. Set the mode switch to FUN.



2. Use the LEFT and RIGHT Keys to display SPCL on the main display.

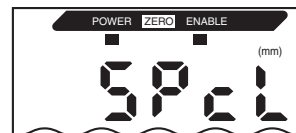

Moving to RESET

3. Press the UP or DOWN Key.

The sub-display will flash.



4. Use the UP and DOWN Keys to display ETC or ALL.



5. Press the ENT Key.



6. Use the LEFT and RIGHT Keys to display RESET on the main display.

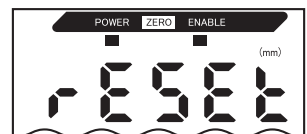

Selecting Output Status for Non-measurement

- 7.** Press the UP or DOWN Key.

The sub-display will flash.



- 8.** Use the UP and DOWN Keys to select either KEEP or CLAMP.



- 9.** Press the ENT Key to confirm the selection.

The output status will be registered.

Next, set the clamp value if CLAMP is selected.



Setting Clamp Values (when CLAMP Is Selected)

- 10.** Use the LEFT and RIGHT Keys to display CLAMP on the main display.

CLAMP cannot be displayed if KEEP has been selected.

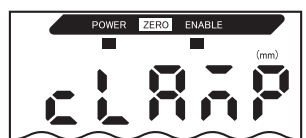

- 11.** Press the UP or DOWN Key.

The sub-display will flash.



- 12.** Select the clamp value.



- 13.** Press the ENT Key to confirm the settings.

The clamp value will be registered.



Calculating Measured Values

This section describes the setting procedure that is used to calculate measured values when Calculating Units are connected by Amplifier Units. Up to 8 Amplifier Units can be used at one time, and measured values can be calculated even when Sensors have different measurement distances.



CHECK! The ZX-L-series Smart Sensors (Laser Type), ZX-E-series Smart Sensors (Linear Proximity Type), and ZX-W-series Smart Sensors (Microwave Type) are not compatible.

Set the expression using an Amplifier Unit starting at CH2.

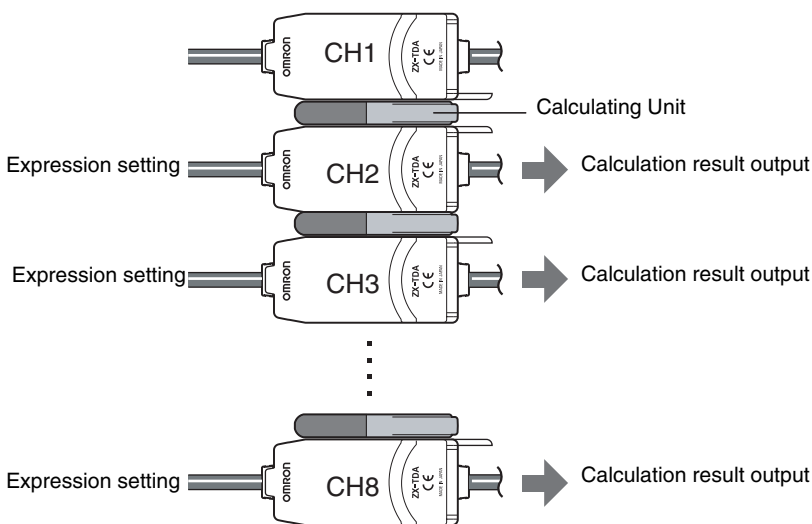

The 2 types of expressions are outlined in the following table.

Expression type	Description	Application
A+B (See note.)	Finds the sum of the measurement results for two Amplifier Units.	<ul style="list-style-type: none"> Measuring thickness Measuring reference surfaces and gaps
A-B (See note.)	Finds the difference between the measurement results for two Amplifier Units.	<ul style="list-style-type: none"> Measuring height difference Measuring flatness

Note: A: Amplifier Unit in which the expression is set (CH2 to CH8)
B: CH1 Amplifier Unit



CHECK!

The response time for CH2 Amplifier Units to which expressions have been set is increased by 1.0 ms. The response time is also influenced by the setting for the number of samples to average, so the response time will be the response time based on the set number of samples to average +1.0 ms.



Setting Number of Samples to Average, p. 70

■ Finding the Height Difference

Use the expression $A - B$. Perform the setting at all Amplifier Units starting from the one at CH2. The following describes the procedure for finding the height difference using the CH2 Amplifier Unit as the example.

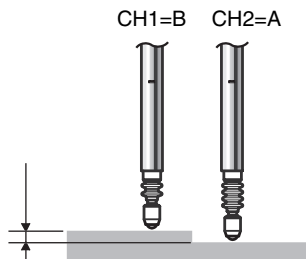

Moving to FUN and CALC

1. Set the mode switch to FUN on the CH2 Amplifier Unit.



2. Use the LEFT and RIGHT Keys to display CALC on the main display.

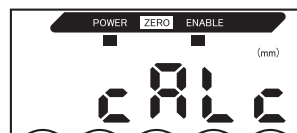

Selecting Expressions

3. Press the UP or DOWN Key.
The sub-display will flash.



4. Use the UP and DOWN Keys to select the expression type.



5. Press the ENT Key to confirm the selection.
The expression will be registered.



Using the Zero Reset Function

When the zero reset function is used, the reference value "0" is registered as the height and the measured value can be displayed and output as a positive or negative deviation (tolerance) from the reference value.

In RUN mode, the measured value can be reset to 0 at any timing during measurement.

Example 1: Using the Height of the Sensing Object as the Reference Value and the Tolerance Output as the Measured Value

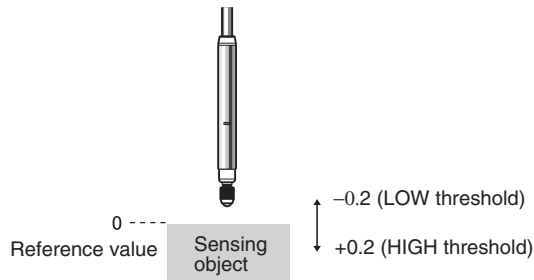

Example 2: Measuring Height Differences on Sensing Objects (Zero Reset at Each Measurement)

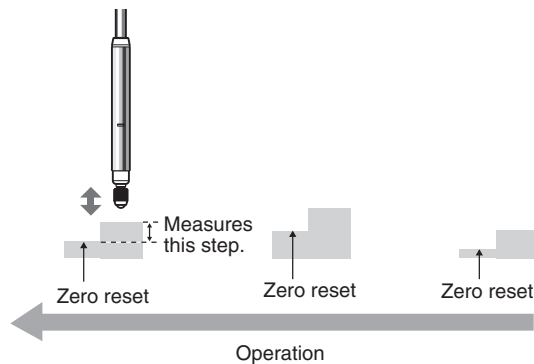

When resetting to zero for each measurement, change the settings so the zero reset level is not saved.

 p. 96

You can set any offset value when you want to set a non-zero measured value.

Example: Measuring the Height Difference of the Sensing Object for Reference
(Setting 1.0 for the offset value)

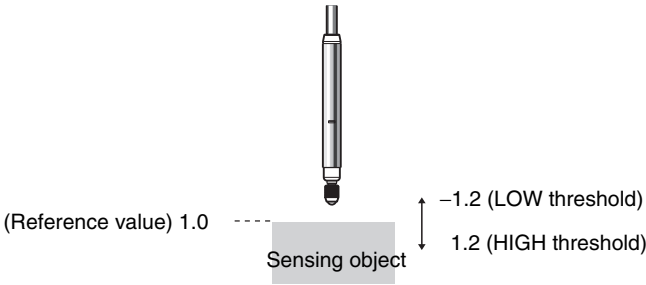

Setting Offset Values

Set an offset value when the reference value for zero reset is a value other than 0.

Moving to FUN and ZRDSP

1. Set the mode switch to FUN.



2. Use the LEFT and RIGHT Keys to display ZRDSP on the main display.

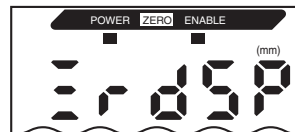

Setting Offset Values

3. Press the UP or DOWN Key.

The leftmost digit of the sub-display will flash.



4. Use the Cursor Keys to set the offset value.



----- Move between digits.



----- Increment and decrement the numeric value.

5. Press the ENT Key to confirm the setting.

The offset value will be registered.



Executing Zero Reset

When the zero reset function is used, the measured value can be reset to a reference value of 0 when the ENT key is pressed or an external signal is input.

If zero reset has already been executed, that value will be overwritten. Execute zero reset within the rated measurement distance. The settings are saved even if the power is turned OFF (default).

 Zero reset memory, p. 96



Linear Output

The measured value when zero reset is executed will be the center value in the linear output range. When monitor focus is set, the measured value will be the center value between the two points set for monitor focus.  Output Settings (Monitor Focus), p. 81

Example

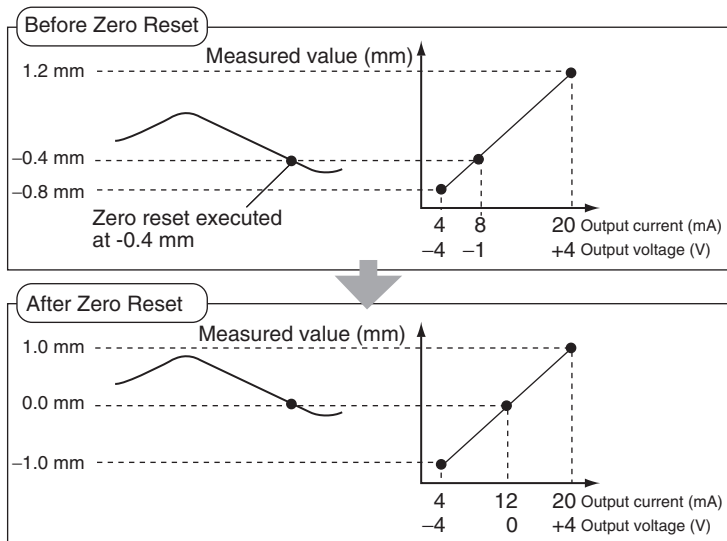

If the following values are displayed after executing zero reset, then the measurement has probably failed.

Example: 5.9999 or - 5.999
Correct the offset value.



A setting can be changed so that the zero reset is released when the power is turned OFF.  Saving Zero Reset Level, p. 96

1. Place the reference sensing object in position.
2. Set the mode switch to RUN.
3. Press the ENT Key for more than one second or input the zero reset signal from an external device (for 800 ms max.).

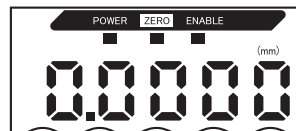

The reference value will be registered and the zero reset indicator will be lit. The tolerance for the registered reference value will be displayed on the main display.

Releasing Zero Reset

1. Set the mode switch to RUN.



2. Hold the ENT and RIGHT Keys down together for about three seconds.
To release zero reset from an external device, input the zero reset signal for one second minimum.



Zero reset will be released and the zero reset indicator will turn OFF.

Saving Zero Reset Level

Select whether or not to hold the measured value zero reset level when the power is turned OFF.

Selection	Details
ON (default)	Saves zero reset level when the power is turned OFF.
OFF	Zero reset is released when the power is turned OFF.



CHECK!

Turn OFF zero reset memory if, as in the example below, the zero point is reset for each measurement. If zero reset memory is enabled, the zero reset level data will be written in the Amplifier Unit non-volatile memory (EEPROM) at each zero reset. The EEPROM can be written a maximum of 100,000 times. Writing the zero reset level for each measurement can, therefore, use up the life of the memory and lead to malfunctions.

Example: Measuring Steps in Sensing Objects

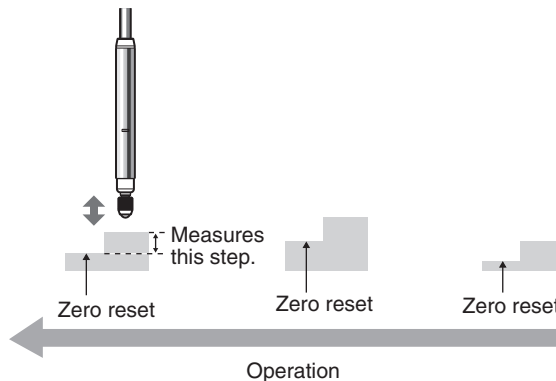

CHECK!

Even if zero reset memory is set to OFF, the zero reset level will be saved if threshold values or other functions have been changed. Zero reset will continue after startup when these functions have been changed.

Moving to FUN and SPCL

1. Set the mode switch to FUN.



2. Use the LEFT and RIGHT Keys to display SPCL on the main display.

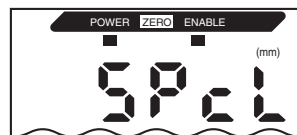

Moving to ZRMEM

3. Press the UP or DOWN Key.

The sub-display will flash.



4. Use the UP and DOWN Keys to display ETC or ALL.



5. Press the ENT Key.



6. Use the LEFT and RIGHT Keys to display ZRMEM on the main display.



Selecting Whether or Not to Enable Zero Reset Memory

7. Press the UP or DOWN Key.

The sub-display will flash.



8. Use the UP and DOWN Keys to select ON or OFF.

ON: Zero reset memory enabled (default)
OFF: Zero reset memory disabled



9. Press the ENT Key to confirm the selection.

The zero reset memory setting will be registered.



Error Output Function

A function has been added that enables using the HIGH/LOW outputs to inform a peripheral device when the Amplifier Unit has detected an error. It's also possible to disable the error output when the plunger has been pressed with excessive force.

Setting	When the plunger has been pressed with excessive force	When any other error has occurred	During normal operation
ON	The HIGH and LOW outputs both turn ON.	The HIGH and LOW outputs both turn ON.	The HIGH,PASS,and LOW outputs are controlled by the judgement results.
STAND (default)		The status set for non-measurement is output.	
OFF	The HIGH,PASS,and LOW outputs are controlled by the judgement results.		



CHECK! If a short-circuit is detected in the judgement outputs(E-sht),the outputs will be stopped to protect the judgement output circuits,and the HIGH/LOW outputs will not turn ON even if the Error Output Function is turned ON.



Error Messages and Countermeasures, p. 116

Moving to FUN and SPCL

1. Move the mode switch to FUN.



2. Use the LEFT and RIGHT Keys to display SPCL on the main display.

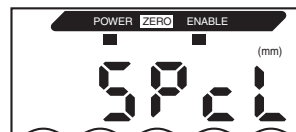

Moving to EROUT

3. Press the UP or DOWN Key.

The sub-display will flash.



4. Display ETC or ALL.



5. Press the ENT Key.



6. Use the LEFT and RIGHT Keys to display EROUT on the main display.

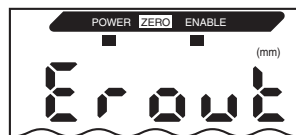

Setting the Error Output Function

7. Press the UP or DOWN Key.

The sub-display will flash.



8. Select the output method to use when an error is detected.



9. Press the ENT Key to confirm the setting.

The setting will be registered.



Section 6

AUXILIARY FUNCTIONS

☒ Changing the Number of Display Digits	102
☒ Reversing the Display	103
☒ Adjusting Display Brightness (ECO Display)	105
☒ Key Lock Function	106
☒ Correcting the Distance Display (Span Adjustment)	107
☒ Initializing Settings Data	109

Changing the Number of Display Digits

Select the number of digits for the main and sub-displays in RUN mode. The default setting is 5 digits. When 4 or less digits are set, the digits are disabled from the rightmost digit first.

Moving to FUN and SPCL

1. Set the mode switch to FUN.



2. Use the LEFT and RIGHT Keys to display SPCL on the main display.

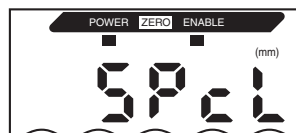

Moving to DIGIT

3. Press the UP or DOWN Key.

The sub-display will flash.



4. Use the UP and DOWN Keys to display DISP or ALL.



5. Press the ENT Key.



6. Use the LEFT and RIGHT Keys to display DIGIT on the main display.



Selecting Number of Digits

7. Press the UP or DOWN Key.

The sub-display will flash.



8. Use the UP and DOWN Keys to select the number of display digits.



9. Press the ENT Key to confirm the setting.



Reversing the Display

The main and sub-digital displays can be reversed, i.e., be turned upside down. The Cursor Key operation will also be reversed. This function is useful when mounting the Amplifier Unit upside down on a device.

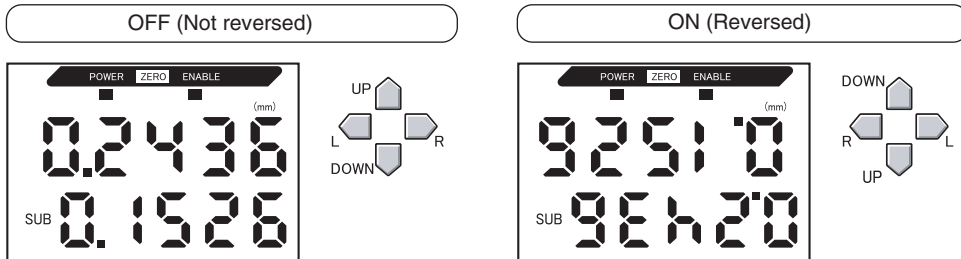

Moving to FUN and SPCL

1. Set the mode switch to FUN.



2. Use the LEFT and RIGHT Keys to display SPCL on the main display.

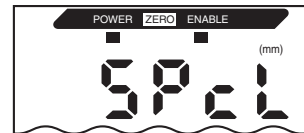

Moving to DREV

3. Press the UP or DOWN Key.
The sub-display will flash.



4. Use the UP and DOWN Keys to display DISP or ALL.



5. Press the ENT Key.



6. Use the LEFT and RIGHT Keys to display DREV on the main display.

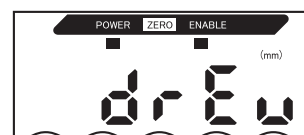

Section 6 AUXILIARY FUNCTIONS

Selecting Whether or Not to Invert Display

7. Press the UP or DOWN Key.

The sub-display will flash.



8. Select either OFF or ON.

OFF: Display not reversed (default)

ON: Display reversed



9. Press the ENT Key to confirm the selection.

The display setting will be registered.

When ON is selected, the display will be reversed.

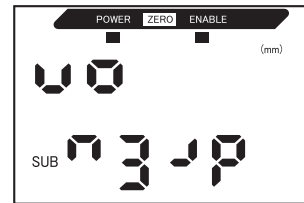

Adjusting Display Brightness (ECO Display)

When the ECO display function is used, the digital displays are not lit, reducing current consumption.

Moving to FUN and SPCL

1. Set the mode switch to FUN.



2. Use the LEFT and RIGHT Keys to display SPCL on the main display.

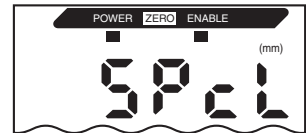

Moving to ECO

3. Press the UP or DOWN Key.

The sub-display will flash.



4. Use the UP and DOWN Keys to display DISP or ALL.



5. Press the ENT Key.



6. Use the LEFT and RIGHT Keys to display ECO on the main display.

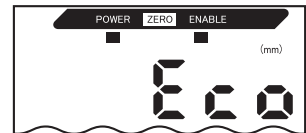

Selecting Whether or Not to Use ECO Display

7. Press the UP or DOWN Key.

The sub-display will flash.



8. Select either OFF or ON.

OFF: Normal display (default)
ON: ECO display



9. Press the ENT Key to confirm the selection.

The display setting will be registered.



When ON is selected, the display will become dark

Key Lock Function

The key lock function disables all Amplifier Unit keys. Once the keys have been disabled, no key input will be accepted until the lock is released. This function is useful to prevent inadvertent changes to settings.

The mode and threshold switches are still enabled even when the key lock function is ON.

Setting the Key Lock

1. Set the mode switch to FUN.



2. Hold down the UP, DOWN, RIGHT, and LEFT Keys at the same time.

LOCK will be displayed on the main display and "-----" will be displayed on the sub-display.

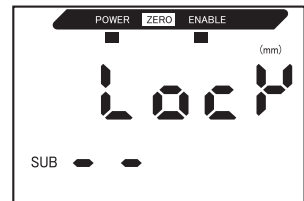
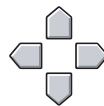

3. Release the keys once OK is displayed on the sub-display.

The keys will be locked.



Releasing the Key Lock

1. Set the mode switch to FUN.



2. Hold down the UP, DOWN, RIGHT, and LEFT Keys at the same time.

FREE will be displayed on the main display and "-----" will be displayed on the sub-display.

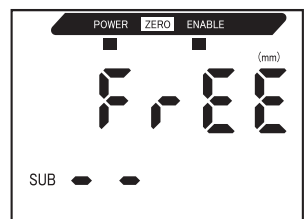
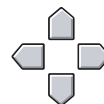

3. Release the keys once OK is displayed on the sub-display.

The key lock will be released.



Correcting the Distance Display (Span Adjustment)

This setting is used to correct discrepancies between the display value and the actual amount of displacement. Set the desired distance (units: μm).



This correction does not change the Sensor's reference position (distance display: 0 mm).

CHECK!



The correction range is about 2% of the measurement distance.
Example: ZX-TDS01T

CHECK!

Measurement distance: 1 mm, range of correction: 20 μm

Example: Actual displacement: 0.5 mm, display value: 0.498 mm

The displacement discrepancy ranges from 0 to 0.5 mm and is 0.002 mm here.
In a range from 0 to -0.5 mm, a discrepancy of 0.002 mm is about what you would expect. If the total discrepancy is 0.004 mm (4.0 μm), then set the correction to 4.0.

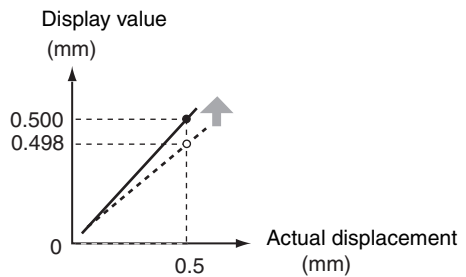
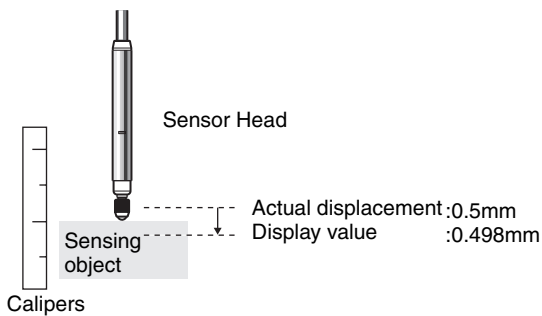

Correction details are registered in the Sensor Head. This means that once done, the correction will not have to be redone even if the Amplifier Unit is replaced.

CHECK!

Moving to FUN and SPCL

1. Set the mode switch to FUN.



2. Use the LEFT and RIGHT Keys to display SPCL on the main display.

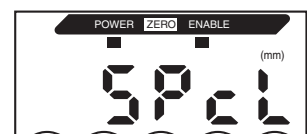

Section 6 AUXILIARY FUNCTIONS

Moving to SPAN

- 3.** Press the UP or DOWN Key.

The sub-display will flash.



- 4.** Use the UP and DOWN Keys to display SET or ALL.



- 5.** Press the ENT Key.



- 6.** Use the LEFT and RIGHT Keys to display SPAN on the main display.

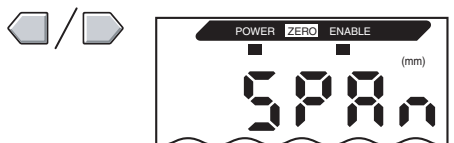

Setting the Distance Correction

- 7.** Press the UP or DOWN Key.

The leftmost digit on the sub-display will flash.



- 8.** Enter the distance correction (μm).

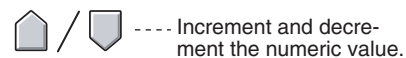
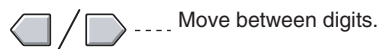

- 9.** Press the ENT Key to confirm the setting.



Initializing Settings Data

This function resets all settings to their default values.
SPAN adjustment settings are not initialized.

Default Values

Function	Default Value
Scale inversion	OFF
No. of samples to average	256
Hysteresis width	Sensor Head resolution specification (Depends on the type of Sensor Head)
Hold	OFF
Zero reset display	0.000 (mm)
Special functions	CLOSE
Monitor focus	At the minimum measurement distance: 4 (mA) At the maximum measurement distance: 20 (mA)
Linear output correction	No correction
Display reverse	OFF
ECO display	OFF
No. of display digits	5 digits (all)
Non-measurement settings	KEEP
Zero reset memory	ON
HIGH threshold	5.999 (mm)
LOW threshold	-1.999 (mm)

- 1.** Set the mode switch to FUN.



- 2.** Use the LEFT and RIGHT Keys to display INIT on the main display.

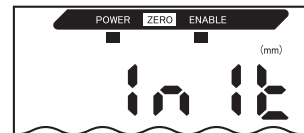

- 3.** Press and hold down the ENT Key.

The sub-display will display "----".



- 4.** Release the ENT Key once OK is displayed on the sub-display

The settings will be initialized.



APPENDICES

☒ Actuators	112
☒ Troubleshooting	115
☒ Error Messages and Countermeasures	116
☒ Q&A	118
☒ Glossary	119
☒ Specifications and Dimensions	120
☒ Characteristic Data (Reference Value)	131
☒ Quick Reference for Displays	132

Actuators

Actuators are replaceable (order separately). Select the correct actuator for the sensing object. Replace worn actuators for more precise measurements.



The ZX-TDS10T-□□ can be used only with the D5SN-TN1 and D5SN-TF1.



Replacing Actuators, p. 113

Selecting Actuators

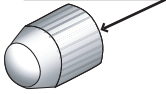
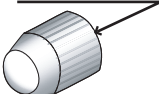
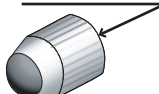
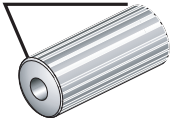
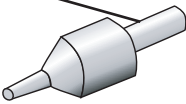
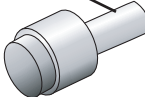
Model	Ball type (steel) D5SN-TB1	Ball type (carbide steel) D5SN-TB2	Ball type (ruby) D5SN-TB3	Conversion adapter D5SN-TA
Appearance	Female screw M2.5×0.45 	Female screw M2.5×0.45 	Female screw M2.5×0.45 	Through hole, female screw M2.5×0.45  Material: Stainless steel
Application	General-purpose measurement on a flat surface (Actuators attached as standard)	Measurement object: Carbide steel (HR90) or softer materials	Measurement object: Carbide steel (HR90) or softer materials	Mounting commercial actuators
Model	Pin type (carbide steel) D5SN-TN1	Ball type (carbide steel) D5SN-TF1		
Appearance	Male screw M2.5×0.45 	Male screw M2.5×0.45 		
Application	Measurements for the bottom of grooves and holes (Requires conversion adapter)	Measurement of spherical surfaces (Requires conversion adapter)		



The following commercial actuators can be mounted using the D5SN-TA conversion adapter.

CHECK!

Model	Appearance	Application
Bowl-shaped		<p>Measurements on slippery surfaces with relatively minor height differences.</p> <p>Measuring film-like sensing objects while sliding over the side of the sensing objects.</p>
Lever		<p>Measurement of narrow pitches.</p>

Replacing Actuators

Be careful not to damage the rubber boot when replacing the actuator.

1. Remove the standard actuator.

Hold the plunger's D-cut section with radio pliers or a similar tool while removing the actuator.



If the replacement must be performed by holding the Sensor Head itself, ensure that a torque exceeding 0.15 N·m is not applied.

CHECK!

Applying excessive torque may have an adverse affect on plunger operation.

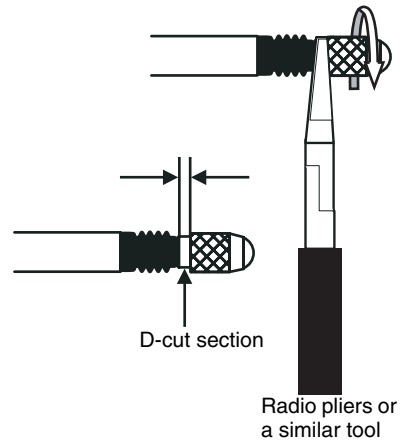

2. Mount the actuator or conversion adapter.

Hold the plunger's D-cut section with radio pliers or a similar tool while mounting and securing the actuator.



If the replacement must be performed by holding the Sensor Head itself, ensure that a torque exceeding 0.15 N·m is not applied.

CHECK!

Applying excessive torque may have an adverse affect on plunger operation.

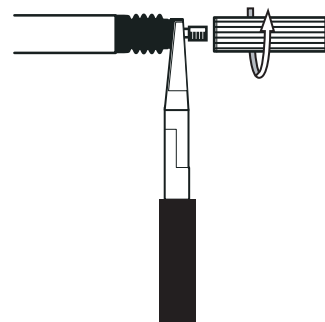

(Only when mounting a commercial actuator)

3. Mount the commercial actuator to the conversion adapter.

- Tighten the actuator securely, and ensure that there is no looseness.
- If necessary, apply a screw-locking agent.

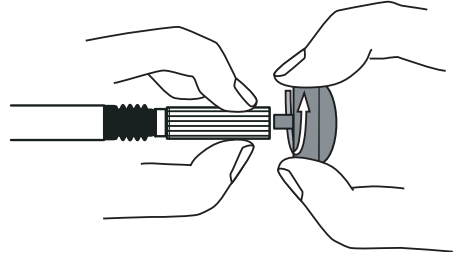

Troubleshooting

This section describes countermeasures for temporary hardware problems. Check the malfunction in this section before sending the hardware for repair.

Problem	Probable cause and possible countermeasure	Pages
POWER indicator not lit.	<ul style="list-style-type: none"> • Is the power supply device connected correctly? • Is the supply voltage below the rated range (12 to 24 VDC \pm10%)? 	p. 34
Device restarts during operation.	<ul style="list-style-type: none"> • Is the power supply device connected correctly? • Are the Interface and Calculating Units connected correctly? 	p. 34 p. 30
Judgements not output to external device.	<ul style="list-style-type: none"> • Are all cables connected correctly? • Is the signal line disconnected? • Are the judgement hold or reset inputs short-circuited? 	p. 34
No input signal received.	<ul style="list-style-type: none"> • Are all cables connected correctly? • Is the signal line disconnected? 	p. 34
No communications with personal computer or Programmable Controller.	<ul style="list-style-type: none"> • Is the cable connected correctly? • Is the Interface Unit connected correctly? • Is the switch under the Interface Unit on the side without the tab? • Is the connector pin arrangement correct? 	p. 30 p. 129
Strange linear output levels.	<ul style="list-style-type: none"> • Is the switch on the bottom of the Amplifier Unit set to the correct position? • Has the correct selection (voltage/current) been made in the monitor focus settings? • Linear output levels can be fine-tuned. 	p. 81 p. 85
Nothing displayed on main display or sub-display.	<ul style="list-style-type: none"> • Has the number of display digits been set to zero? 	p. 102
The main display remains on "----".	<ul style="list-style-type: none"> • Has timing been input properly with a P-H, B-H, S-H, or PP-H hold enabled? • Has the self-trigger level been set to an appropriate value with an SP-H or SB-H hold enabled? 	p. 71

Error Messages and Countermeasures



This section outlines the error messages displayed on the main display and the countermeasures for those messages.

Display	Error	Countermeasure	Pages
E-CHL	There are two Sensors but only one Amplifier Unit connected	<ul style="list-style-type: none"> • If two Amplifier Units have been connected, turn OFF the power supply and check that the Amplifier and Calculating Units are connected correctly. • If only one Amplifier Unit is being used, connect another Amplifier Unit temporarily and turn OFF the two-sensor operation, or initialize the settings data. 	p. 21 p. 31 p. 90 p. 109
E-DAT	Two-sensor operation communications data error	<ul style="list-style-type: none"> • Check to see if there is a CH1 Amplifier Unit error. If there is, clear the error. • Change the mode for the CH1 Amplifier Unit to RUN. • Turn OFF the power supply and check that the Amplifier and Calculating Units are connected correctly. Replace the Amplifier Unit or the Calculating Unit if the above countermeasures do not solve the problem. 	p. 21 p. 31 p. 42
E-EEP	EEPROM data error	Hold down the ENT Key for three seconds or longer. Once the data has been cleared, cycle the power supply. Replace the Amplifier Unit if the above countermeasure does not solve the problem.	p. 44
E-HED	The Sensor Head is disconnected.	Turn OFF the power supply, check that the Sensor Head is connected correctly, and then turn ON the power supply. Replace the Sensor Head if the above countermeasure does not solve the problem.	p. 30
E-SEN	The Sensor Head is disconnected or other factors are causing it to malfunction.	Turn OFF the power supply, check the connection for the Sensor Head, and then turn ON the power supply again. Replace the Sensor Head if the above countermeasure does not solve the problem.	p. 30
E-SHT	One or all of the judgement outputs are short-circuited.	Turn OFF the power supply, check that the HIGH, PASS, and LOW output lines are not short-circuited, then turn ON the power supply again.	p. 34
ERRLH	An attempt was made to set a numeric value larger than the HIGH threshold value to the LOW threshold value.	Input correct threshold values.	p. 77
	HIGH threshold– LOW threshold < hysteresis width		







Error Messages and Countermeasures (Continued)

Display	Error	Countermeasures	Pages
ERRHL	An attempt was made to set a numeric value smaller than the LOW threshold value to the HIGH threshold value.	Input correct threshold values.	p. 77
	HIGH threshold – LOW threshold < hysteresis width		
ERROV	The set numeric value is too large.	Input an appropriate numeric value.	p. 46
	HIGH threshold – LOW threshold < hysteresis width		p. 77
ERRUD	The set numeric value is too small.	Input an appropriate numeric value.	p. 46
OVER	The plunger pressing force is excessive.	Adjust the detection position of the Sensor Head and the position of the sensing object.	p. 37

Q&A

Question	Answer
Can the cable between Sensor Heads and the Preamplifiers be extended?	No. If the cable is extended, measurement precision is lost.
Can calculations be performed with ZX-L-series Smart Sensors (Laser Type), ZX-W-series Smart Sensors (Microwave Type), and ZX-E-series Smart Sensors (Linear Proximity Type)?	No. The ZX-L-series Smart Sensors (Laser Type), ZX-W-series Smart Sensors (Microwave Type), and ZX-E-series Smart Sensors (Linear Proximity Type) do not support calculations.
Is the ZX-SF-11 Interface Unit used with the ZX-L-series Smart Sensors (Laser Type), ZX-W-series Smart Sensors (Microwave Type), and ZX-E-series Smart Sensors (Linear Proximity Type) compatible with the ZX-T-series Smart Sensors (Inductive Displacement Type)?	Yes, if the Interface Unit is version 2.0 or later. If the Interface Unit is an earlier version, contact your OMRON representative. (The Interface Unit version can be checked through the following procedure.) <ul style="list-style-type: none"> • Enter the version check command using a personal computer or Programmable Controller. • Check using the ZX-L-series and ZX-E-series Smart Monitor.
Why does an error occur and settings cannot be made when teaching or directly inputting threshold values?	Threshold values cannot be set using teaching or by direct input if the following condition is not met: <ul style="list-style-type: none"> • HIGH threshold value – LOW threshold value > hysteresis width  p. 77
When monitor focus is executed, why does an error appear on the sub-display and the settings cannot be made?	Monitor focus settings cannot be made when the distance between the two specified points is not 1% or more of the measurement distance.  p. 81
Can calculations be performed with 9 or more Amplifier Units?	Contact your OMRON representative.
Can calculations be performed when Sensor Heads with different measurement distances are connected to 2 Amplifier Units?	Yes, if both Sensors are ZX-T-series Smart Sensors (Inductive Displacement Type).
The change in the measured value displayed on the Amplifier Unit was not the same as the actual displacement. How do I correct this?	Use the span adjustment function to make the change in the measured value agree with the actual displacement. You can also try adjusting the mounting position of the Sensor Head (i.e., the detection distance), or use the zero reset to match the values.
The Sensor Head has been broken. What needs to be done?	If the Sensor Head is replaced with the same model, the original settings will be available as soon as the new Sensor Head is installed. (Only reset the span adjustment.)
The Amplifier Unit has been broken. What needs to be done?	Just replace the failed Amplifier Unit with a new one. (The span adjustment does not have to be reset. Reset the threshold values and other functions.)

Glossary

Term	Explanation
Response time	The time it takes the ZX-T Sensor to output a value (either as linear output or judgement output) after it measures a distance. The response time changes depending on the settings for the number of samples to average and the calculations.
Measured value	The measurement result displayed on the main display of the Amplifier Unit in RUN and T modes. The measured value is the value after all set processing has been completed, e.g., the number of samples to average, calculations, hold, scale inversion, and zero reset.  p. 47
Present value	The current measurement result for the target Amplifier Unit. Some set processing, such as the number of samples to average and scale inversion, are reflected in the current measured value, but calculation, hold, and zero reset settings are not. Press the LEFT or RIGHT Key in RUN mode to display the present value on the sub-display.  p. 47
Linearity	The error in an ideal straight line displacement output when measuring the standard sensing object. The linearity shows how closely the linear output maintains a linear relationship to the displacement of the sensing object (i.e., it shows the accuracy of the linear output). More precise linearity can be obtained with ZX-T Smart Sensors by performing span adjustment.  p. 107
Hold	A function that holds specified measurement values such as the maximum or minimum value during the sampling time and it outputs that value when the measurement is completed.  p. 71
Linear output	The linear output is analog data output from the linear output line. Either a current or voltage output can be selected. The linear output is made based on the display value and monitor focus settings. The actual value output (the output value) can be displayed on the sub-display by pressing the LEFT or RIGHT Key in RUN mode.  p. 47
Judgement outputs	“Judgement outputs” is a general term for the HIGH, PASS, and LOW outputs. The judgement outputs are made in RUN and T mode based on the display values and the threshold, hysteresis width, and timer settings. The judgement output is held while judgement output hold input is ON.
Measurement distance	The range within which measurements can be made by the connected Sensor Head.  p. 126
Sampling period	The time over which the sensing object is measured when the hold function is being used. The sampling period is determined by the hold condition.  p. 71
Warming up time	Time it takes until the Sensor Head is ready to measure at the specified resolution after the power is turned ON. With the ZX-T Sensor Head, W-UP is displayed on the Amplifier Unit sub-display until the Sensor Head has warmed up.

Specifications and Dimensions

ZX-TDA11/ZX-TDA41 Amplifier Units

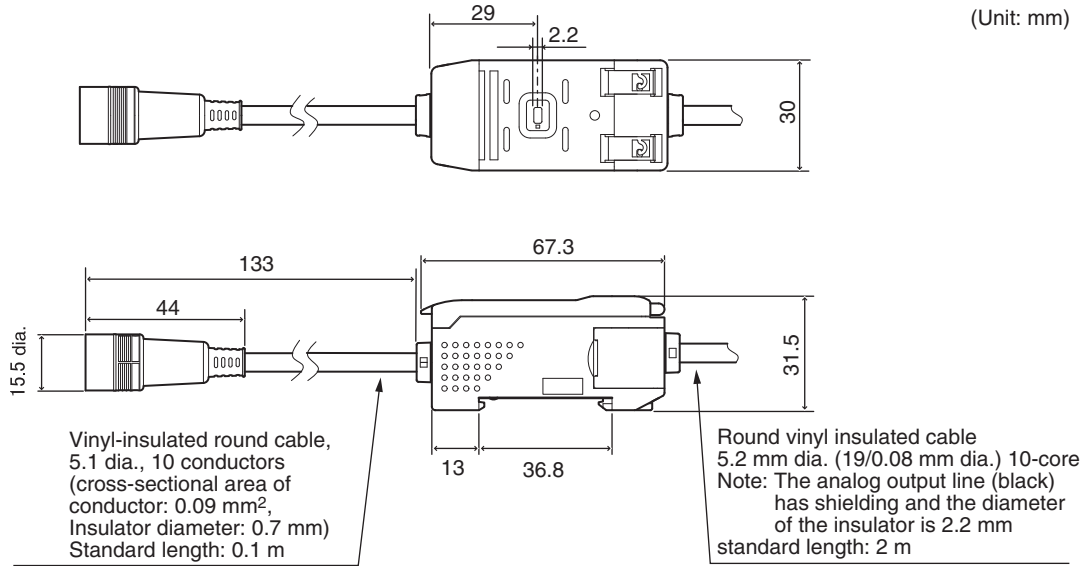

	ZX-TDA11	ZX-TDA41	
Measurement period	1 ms		
Possible settings for number of samples to average (See note 1.)	1, 2, 4, 8, 16, 32, 64, 128, 256, 512 or 1024		
Linear output (See note 2.)	Current output: 4 to 20 mA/F.S., Max. load resistance: 300 Ω Voltage output: ± 4 V (± 5 V, 1 to 5 V, See note 3.), Output impedance: 100 Ω		
Judgement outputs (3 outputs: HIGH/PASS/LOW)	NPN open-collector outputs, 30 VDC, 30 mA max. Residual voltage: 1.2 V max.	PNP open-collector outputs, 30 VDC, 30 mA max. Residual voltage: 2 V max.	
Judgement output hold input	ON: Short-circuited with 0-V terminal or 1.5 V or less OFF: Open (leakage current: 0.1 mA max.)	ON: Supply voltage short-circuited or within supply voltage of 1.5 V max. OFF: Open (leakage current: 0.1 mA max.)	
Zero reset input			
Timing input			
Reset input			
Functions	Measured value display Present value display Output value display Set value display ENABLE indicator Zero reset indicator Power ON indicator Judgement indicator ECO mode Display reverse Display digit limit Zero reset	Zero reset memory Initialization Hysteresis width setting Scale inversion Span adjustment Monitor focus Linear output correction Timing input (A-B) calculations (See note 4.) (A+B) calculations (See note 4.)	Clamp value setting Key lock Peak hold Bottom hold Sample hold Peak-to-peak hold Teaching Direct threshold value setting Self-peak hold Self -bottom hold Warming up display
Indications	Judgement indicators: HIGH (orange), PASS (green), LOW (yellow), 7-segment main display (red), 7-segment sub-display (yellow), power ON (green), zero reset (green), enable (green)		
Power supply voltage	12 to 24 VDC $\pm 10\%$, Ripple (p-p): 10% max.		
Current consumption	140 mA max. with power supply voltage of 24 V (Sensor connected)		
Ambient temperature	Operating and storage: 0 to 50°C (with no icing or condensation)		
Ambient humidity	Operating and storage: 35% to 85% (with no condensation)		
Insulation resistance	20 M Ω min. at 500 VDC		
Dielectric strength	1,000 VAC, 50/60 Hz for 1 min		
Vibration resistance (destructive)	10 to 150 Hz, 0.7-mm double amplitude 80 min each in X, Y, and Z directions		
Shock resistance (destructive)	300 m/s ² 3 times each in six directions (up/down, left/right, forward/backward)		
Connection method	Prewired (standard cable length: 2 m)		
Weight (packed state)	Approx. 350 g		
Materials	Case: PBT (polybutylene terephthalate), Cover: Polycarbonate		
Accessories	Instruction sheet		

- Notes:**
1. The response speed of the linear output is calculated as the measurement period x (No. of samples to average setting + 1).
The response speed of the judgement outputs is calculated as the measurement period x (No. of samples to average setting + 1).
 2. The output can be switched between current output and voltage output using a switch on the bottom of the Amplifier Unit.
 3. Setting is possible via the monitor focus function.
 4. A Calculating Unit is required.

ZX-TDS□□T Sensor Heads

(Unit: mm)

Sensor Heads

ZX-TDS01T

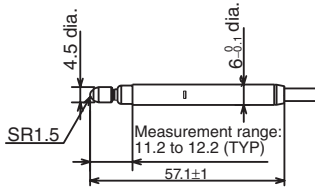

ZX-TDS04T/04T-L

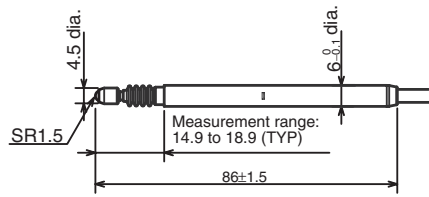

ZX-TDS10T

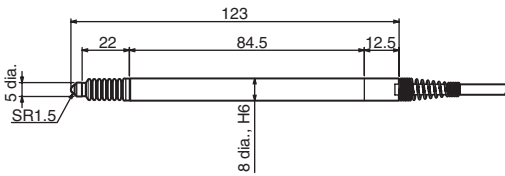

Right-angle Adapter

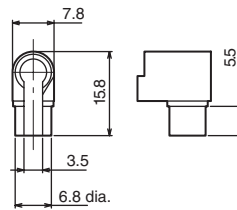

ZX-TDS10T-V

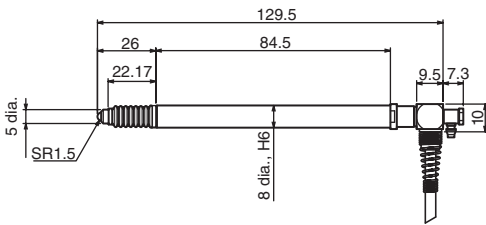

ZX-TDS10T-L

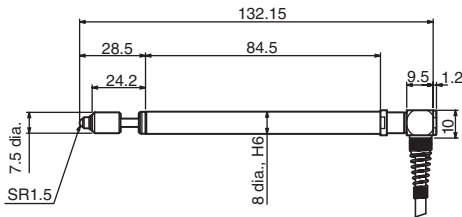

ZX-TDS10T-VL

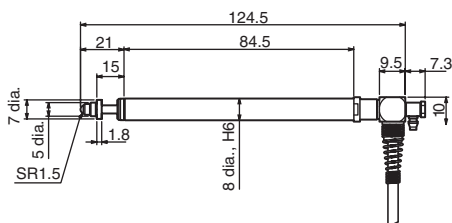

**Preamplifier
(Same for all models)**

Round vinyl-insulated shielded coaxial cable,
3 cores, 3.7 dia.
Standard length: 2 m

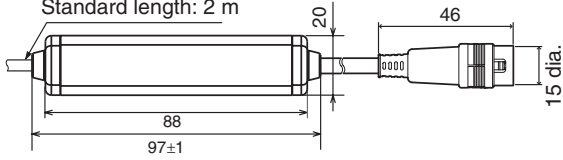

Round vinyl-insulated coaxial cable,
19 cores, 5.1 dia.
Standard length: 0.2 m

**Preamplifier
(with Mounting Bracket)**

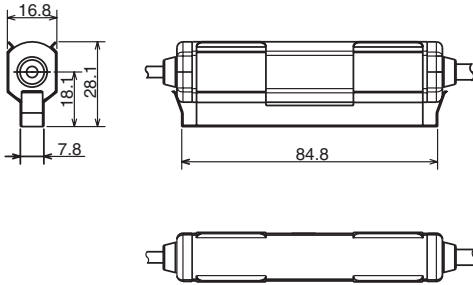

Preamplifier Mounting Bracket

ZX-XBT1

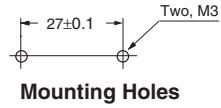
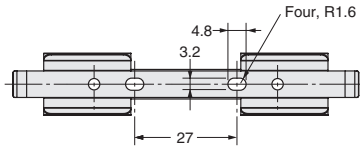

Mounting Holes

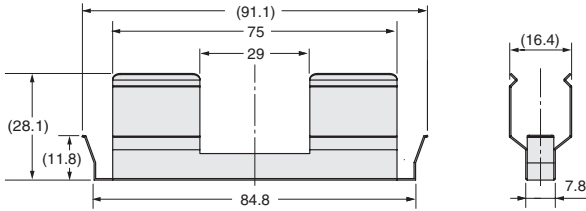

ZX-XBT2 (for DIN Track mounting)

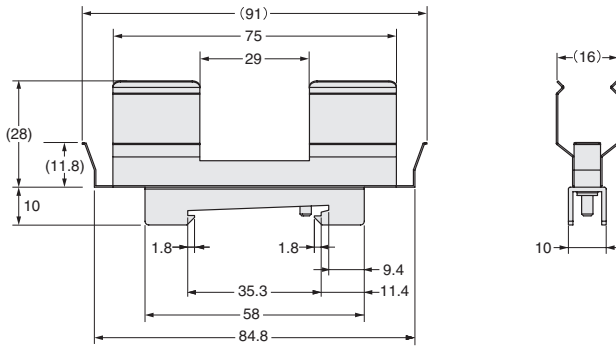
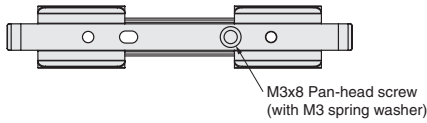

		ZX-TDS01T	ZX-TDS04T	ZX-TDS04T-L
Applicable Amplifier Unit		ZX-TDA11/ZX-TDA41		
Measurement distance		1 mm	4 mm	
Maximum actuator travel distance		Approx. 1.5 mm	Approx. 5 mm	
Resolution (*1)(*2)		0.1 μm		
Linearity (*2)		0.3 %F.S.		
Operating force (*3)		Approx. 0.7 N		Approx. 0.25 N
Degree of protection (IEC60529 standard)	Sensor Head	IP67		IP54
	Preamplifier	IP40		
Mechanical durability		10,000,000		
Ambient temperature		Operating: 0 to 50°C (with no icing or condensation) Storage: -15 to 60°C (with no icing or condensation)		
Ambient humidity		Operating/storage: 30% to 85% (with no icing or condensation)		
Temperature influence (*4)	Sensor Head	0.03 %F.S./°C	0.01 %F.S./°C	
	Preamplifier	0.01 %F.S./°C		
Materials	Sensor Head	Stainless steel		
	Rubber boot	Fluorocarbon rubber	Silicon rubber	
	Preamplifier	Polycarbonate resin		
	Mounting Bracket	Stainless steel		
Weight		Approx. 100 g		
Accessories		ZX-XBT1 Preamplifier Mounting Bracket, Instruction Sheet		

F.S.: Full scale of measurement distance

- Notes:**
1. The minimum value that can be read when the ZX-TDA11/41 Amplifier Unit is connected (No. of samples to average: 256).
 2. The value at Ta = 20°C
 3. The typical value at the center of the range of movement.
 4. The typical value at the center of the measurement distance.

		ZX-TDS10T	ZX-TDS10T-V	ZX-TDS10T-L	ZX-TDS10T-VL
Vacuum retract (VR) and air push (AP) supported.		No	VR	No	VR/AP
Measurement distance		10 mm			
Maximum actuator travel distance		10.5 mm			
Resolution (*1)(*5)		0.4 μm			
Linearity (*2)(*5)		±0.5% F.S.			
Operating force(*3)		Approx. 0.7 N	Approx. 0.6 N	Approx. 0.065 N	Approx. 0.09 to 1.41 N
Air pressure	Vacuum retract	---	-0.55 to -0.70 bar	---	-0.22 to -0.5 bar
	Air push	---	---	---	0.125 to 2 bar

		ZX-TDS10T	ZX-TDS10T-V	ZX-TDS10T-L	ZX-TDS10T-VL
Degree of protection	Sensor Head	IP65		IP50	
	Preamplifier	IP40			
Mechanical durability		10,000,000 operations min.			
Ambient temperature		Operating: 0 to 50°C, Storage: -10 to 60°C			
Ambient humidity		Operating/storage: 35% to 85% (with no icing or condensation)			
Temperature influence (*4)	Sensor Head	±0.01%F.S./°C			
	Preamplifier	±0.01%F.S./°C			
Vibration resistance		10 to 55 Hz, 0.35-mm single amplitude 50 min each in X, Y, and Z directions			
Shock resistance		150 m/s ² 3 times each in six directions (up/down, left/right, forward/backward)			
Connection method		Junction connector (between Sensor Head and Preamplifier: 2 m, between Preamplifier and Connector: 0.2 m)			
Weight (Packed)		Approx. 100 g			
Materials	Sensor Head	Stainless steel			
	Rubber boot	Viton	None	None	
	Preamplifier	Polycarbonate			
	Mounting bracket	Stainless steel			
Accessories		Instruction Sheet, ZX-XBT1 Preamplifier Mounting Bracket, Right-angle Adapter (*6)			

- Notes:**
1. This indicates the deviation width ($\pm 3 \sigma$) in the linear output (i.e., voltage output) when the Sensor is connected to the ZX-TDA.
This is the value 30 minutes after turning ON the power supply with the average number of operations set to 1024. The display (i.e., the minimum value that can be read) will show 1 μm .
 2. Linearity is the error from the ideal line.
 3. The typical value at the center of measurement when the standard included Actuator is attached and secured facing downward.
 - ZX-TDS10T or ZX-TDS10T-V: The measurement capability will decrease if the Sensor is mounted horizontally or facing upward.
 - ZX-TDS10T-L: Only facing downward mounting is possible.
 4. Temperature influence is the typical value at the center of the measurement distance.
 5. This is the value for an ambient temperature of 23°C.
 6. The Right-angle Adapter is an accessory for the ZX-TDS10T.

ZX-CAL2 Calculating Unit

(Unit: mm)

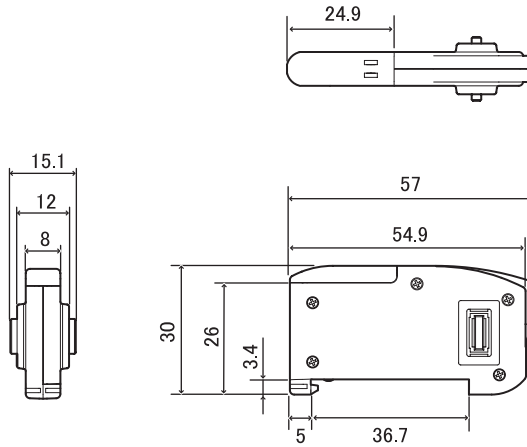

Applicable Amplifier Units	ZX Series
Current consumption	12 mA max. (supplied from the Smart Sensor Amplifier Unit)
Ambient temperature	Operating: 0 to 50°C, Storage: -15 to 60°C (with no icing or condensation)
Ambient humidity	Operating and storage: 35% to 85% (with no condensation)
Connection method	Connector
Dielectric strength	1,000 VAC, 50/60 Hz for 1 min
Insulation resistance	100 MΩ (at 500 VDC)
Vibration resistance (destructive)	10 to 150 Hz, 0.7-mm double amplitude 80 min each in X, Y, and Z directions
Shock resistance (destructive)	300 m/s ² 3 times each in six directions (up/down, left/right, forward/backward)
Materials	Display: Acrylic, Case: ABS resin
Weight (packed state)	Approx. 50 g
Accessories	Instruction Sheet

ZX-SF11 Interface Unit

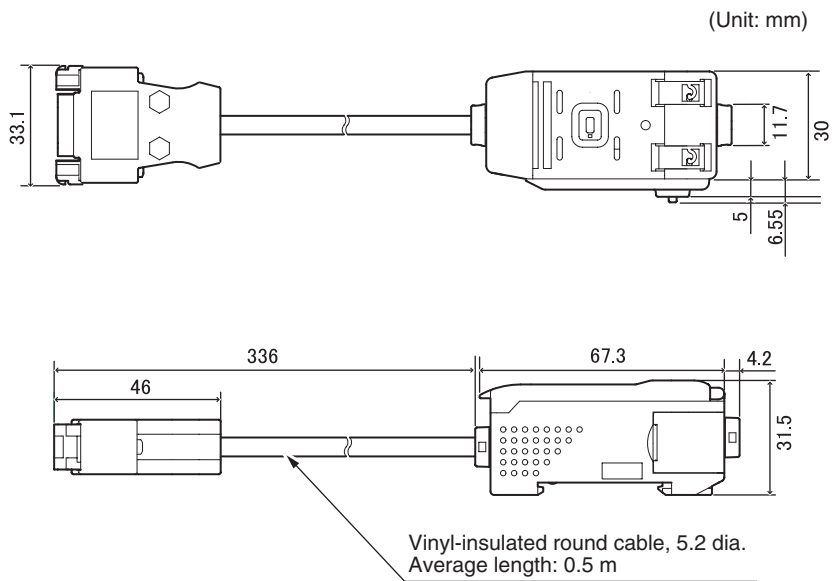

Connector pin arrangement

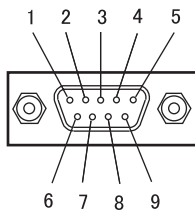

Pin No.	Name
1	N.C.
2	RD
3	SD
4	N.C.
5	SG
6	N.C.
7	N.C.
8	N.C.
9	N.C.

Power supply voltage		12 to 24 VDC \pm 10%, Ripple (p-p) 10% max. Supplied from Amplifier Unit
Current consumption		Power supply voltage: 12 V, Current consumption: 60 mA max. (Excluding Amplifier Unit current consumption and output current.)
Connectable Amplifier Units		ZX Series
No. of Amplifier Units connectable		Up to 5 (Two Calculating Units max.)
Communications functions	Communications port	RS-232C port (9-pin D-sub connector)
	Protocol	CompoWay/F
	Baud rate	38,400 bps
	Data configuration	Data bits: 8, Parity: None; Start bits: 1 Stop bits: 1, Flow control: None
Indicators		Power ON (green), Communicating with Sensor (green), Sensor communications error (red) Communicating with external terminal (green), External terminal communications error (red)
Protection circuits		Reverse power supply wiring protection
Ambient temperature		Operating: 0 to 50°C, Storage: -15 to 60°C (with no icing or condensation)
Ambient humidity		Operating and storage: 35% to 85% (with no condensation)
Dialectic strength		1,000 VAC, 50/60 Hz for 1 min
Insulation resistance		20 M Ω min. (at 500 VDC)
Case materials		Case: PBT (polybutylene terephthalate), Cover: Polycarbonate
Weight (packed state)		Approx. 350 g

Characteristic Data (Reference Value)

Output Characteristics (Voltage/Current Output)

ZX-TDS01T/TDS04T-□/ZX-TDS10T-□□

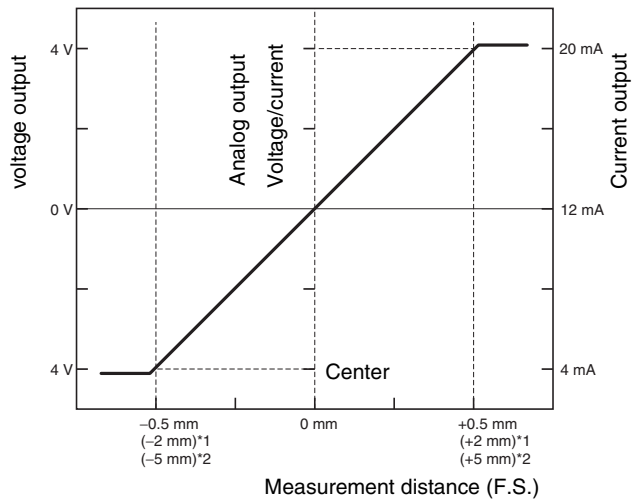

*1 The value for the ZX-TDS04T/TDS04T-□.

*2 The value for the ZX-TDS10T/TDS10T-□□.

*3 Displacement direction

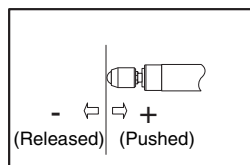

Quick Reference for Displays

Using the Quick Reference

Items in the *Display* column marked with an asterisk (*) appear on the sub-display. All other items appear on the main display.

	Display		Details	Pages
A	A20mA	A20mA	The meaning of this display item depends on the selected functions. Monitor focus/First point setting (for current output) Linear output correction/First point offset (for current output)	p. 81 p. 85
	A 4V	A 4V	The meaning of this display item depends on the selected functions. Monitor focus/First point setting (for voltage output) Linear output correction/First point offset (for voltage output)	p. 81 p. 85
	A-b (*)	A-B	2-sensor operation/A-B	p. 90
	A 1b (*)	A1B	2-sensor operation/A+B	p. 90
	ALL (*)	ALL	Displays all of the special menu.	p. 48
	AVE	AVE	Number of samples to average setting	p. 70
B	B 4mA	B 4mA	The meaning of this display item depends on the selected functions. Monitor focus/Second point setting (for current output) Linear output correction/Second point offset (for current output)	p. 81 p. 85
	B 4V	B 4V	The meaning of this display item depends on the selected functions. Monitor focus/Second point setting (for voltage output) Linear output correction/Second point offset (for voltage output)	p. 81 p. 85
	B-h (*)	B-H	Hold/Bottom hold	p. 71
C	CALC	CALC	Calculation setting for adjacent Sensors	p. 90
	CLAMP	CLAMP	Clamp value setting for non-measurement	p. 88
	CLAMP (*)	CLAMP	Non-measurement setting/Return output to clamp value	p. 88
	CLOSE (*)	CLOSE	Hides the special menu.	p. 48
D	DIGIT	DIGIT	Number of digits setting for main and sub-displays	p. 102
	DREV	DREV	Reverses position of main and sub-displays.	p. 103
	DISP (*)	DISP	Displays display-related functions from special menu.	p. 48
E	ECO	ECO	Reduces power consumption by reducing main and sub-display lighting.	p. 105
	EROUT	EROUT	Error output setting.	p. 98
	ETC (*)	ETC	Displays functions other than display- and output-related functions from special menu.	p. 48
F	FOCUS	FOCUS	Measured value output range setting	p. 81

Display		Details		Pages
H	h-hYS	H-HYS	Hold/Trigger mode/Self-trigger hysteresis width setting.	p. 71
	h-LVL	H-LVL	Hold/Trigger mode/Self-trigger level setting.	p. 71
	hold	HOLD	Hold setting	p. 71
	hYS	HYS	Hysteresis width setting	p. 80
I	in It	INIT	Initialization of settings	p. 109
	Inv	INV	Positive and negative value inversion	p. 75
K	KEEP (*)	KEEP	Non-measurement settings/Hold output	p. 88
L	L-Adj	L-ADJ	Linear output offset value setting	p. 85
M	mA (*)	mA	Special, monitor focus, and current output setting	p. 81
	MAX (*)	MAX	Non-measurement settings/Clamp value/Maximum	p. 88
P	P-h (*)	P-H	Hold/Peak hold	p. 71
	PP-h (*)	PP-H	Hold/Peak-to-peak hold	p. 71
R	RESET	RESET	Output data settings for non-measurement	p. 88
	RESET (*)	RESET	RUN or T mode/Resetting input	p. 34
S	S-h (*)	S-H	Hold/Sample hold	p. 71
	SB-h (*)	SB-H	Hold/Self-bottom hold	p. 71
	SET (*)	SET	Displays output-related functions from the special menu.	p. 48
	SP-h (*)	SP-H	Hold/Self-peak hold	p. 71
	SPAN	SPAN	Setting for correcting the distance value on the display	p. 107
	SPCL	SPCL	Special menu item Displays monitor focus and other special functions	p. 48
	STAND	STAND	Enable/disable setting for error output.	p. 98
T	TIMIG (*)	TIMIG	RUN or T modes: Input timing	p. 34
V	VOLT	VOLT	Special, monitor focus, and voltage output setting	p. 81
W	W-UP	W-UP	Displayed during warm-up	p. 36
Z	ZRDSP	ZRDSP	Offset value input for zero reset	p. 94
	ZRMEM	ZRMEM	Setting to save or clear measured values at zero reset	p. 95

Index

A

alphabet display format	43
Amplifier Units	
dimensions	120
installation	24
measuring with multiple Units	102
part names	21
specifications	121

B

basic configuration	20
---------------------------	----

C

cable length	16, 17
Calculating Units	
connections	31
dimensions and specifications	128
part names	22
channel numbers	32
characteristic data	
(reference value)	131
circuit diagrams	
NPN Amplifier Units	35
CLAMP	88
CLAMP value	88
current/voltage switch	21
cursor keys	44

D

default values	
settings data	109
dimensions	120
direct input	78
displays	
adjusting brightness	105
reversing	103

E

ECO display	105
ENABLE indicator	21
error messages	116
Error Output Function	98

F

FUN mode	
description	42
displays	43
function transitions	48
function transition charts	47

G

ground line	34
-------------------	----

H

HIGH judgement output line	34
hold	
bottom	71
functions	71
peak	71
peak-to-peak	72
sample	72
hysteresis width	80

I

I/O circuit diagrams	35
initialize	
settings data	109
Interface Units	
connections	33
connector pin arrangement	129
dimensions and specifications	129
part names	23

J

judgement output hold input line	34
--	----

K

KEEP	88
key input	
disabling	106
key lock	
releasing	106
setting	106
key operations	44

L

linear output	81
output compensation	85
switch	21
linear output ground line	34
linear output line	34
LOW judgement output line	34

M

main display	43
measured value	119
mode switch	42
modes	42

- switching 42
-
- N**
- No. of samples to average 70
 - non-measurement settings 88
 - numerals
 - changing 46
-
- O**
- output cable 34
 - output compensation 85
 - output settings 81
-
- P**
- PASS judgement output line 34
 - position teaching 79
 - Power ON indicator 21
 - Preamplifiers 29
 - present value 119
-
- Q**
- Q&A 118
-
- R**
- reference values
 - displaying 92
 - setting offset values 94
 - reset input line 34
 - response time 90, 119
 - RUN mode
 - description 42
 - displays 43
 - function transitions 47
-
- S**
- Sensor Heads 26
 - connections 30
 - dimensions 123
 - installation 26
 - part names 22
 - setting conditions
 - selecting 45
 - settings
 - initializing 109
 - specifications 120
 - sub-display 43
-
- T**
- T mode
 - description 42
 - displays 43
 - function transitions 47
- teaching 77
 - terminology 119
 - thresholds
 - entering values 77
 - inputting directly 78
 - position teaching 79
 - switch 21
 - timing
 - input line 34
 - troubleshooting 115
-
- W**
- warming up 9, 17, 36, 37, 133
 - wiring 34
-
- Z**
- zero reset 92
 - executing 95
 - input line 34
 - releasing 96
 - saving 96, 98
 - setting offset values 94

Revision History

A manual revision code appears as a suffix to the catalog number at the bottom of the front and back covers of this manual.

Cat. No. E346-E1-06

↑
Revision code

Revision code	Date	Revised contents
01	Jan. 2004	Original production
02	June 2004	Page 38: Diagram added for PNP Amplifier Unit. Page 83: Paragraph added before example, numeric values in example changed, and graph added. Page 84: Numeric values at top of page changed and graph added. Page 86: Values on display illustrations changed. Page 119: Model number added to heading. Page 120: Specifications added for the ZX-TDA41. Page 124: Model number added at top of table.
02A	February 2005	The warranty and liability information at the beginning of the manual was replaced. The following change was also made. Page 20: ZX-TDA11 changed to ZX-TDA11/41 in diagram.
03	October 2005	Pages 7 and 8: Power supply and wiring precaution added. Page 8: Model number restriction added to third power supply and wiring precaution. Page 9: Model number restrictions and precaution added to end of <i>Sensor Head</i> . Page 26: New model of Mounting Jig added and text for previous Mounting Jig altered. Page 33: Information added to second <i>CHECK</i> information. Page 108: CHECK information added at beginning of <i>Actuators</i> . Page 118: Sensor Head diagrams added. Page 109: Model number restriction added to <i>Replacing Actuators</i> . Page 120: <i>Repeat accuracy</i> information and related note deleted. Table added. Page 124: Model numbers added and text between figures changed.
04	July 2006	Page 46: Error output display added. Pages 96 and 125 to 127: Information on error output function added. Page 126: Changed vacuum retract air pressure for ZX-TDS10T-VL in table.
05	January 2014	Front matter: Replaced information from "READ AND UNDERSTAND THIS DOCUMENT" through "COPYRIGHT AND COPY PERMISSION." Page 131: Added "Reference Value" to heading.
06	July 2015	Page7: Added Applicable standards page8: Changed cable extension page120: Added callouts to figure.

OMRON Corporation Industrial Automation Company
Tokyo, JAPAN

Contact: www.ia.omron.com

Regional Headquarters

OMRON EUROPE B.V.

Sensor Business Unit

Carl-Benz-Str. 4, D-71154 Nufringen, Germany
Tel: (49) 7032-811-0/Fax: (49) 7032-811-199

OMRON ASIA PACIFIC PTE. LTD.

No. 438A Alexandra Road # 05-05/08 (Lobby 2),
Alexandra Technopark,
Singapore 119967
Tel: (65) 6835-3011/Fax: (65) 6835-2711

OMRON ELECTRONICS LLC

One Commerce Drive Schaumburg,
IL 60173-5302 U.S.A.
Tel: (1) 847-843-7900/Fax: (1) 847-843-7787

OMRON (CHINA) CO., LTD.

Room 2211, Bank of China Tower,
200 Yin Cheng Zhong Road,
PuDong New Area, Shanghai, 200120, China
Tel: (86) 21-5037-2222/Fax: (86) 21-5037-2200

Authorized Distributor:

© OMRON Corporation 2004 All Rights Reserved.
In the interest of product improvement,
specifications are subject to change without notice.

Cat. No. E346-E1-06

0715