

OMRON

Automation Software

Sysmac Studio Version 1

Operation Manual

SYSMAC-SE2□□□



NOTE

1. All rights reserved. No part of this publication may be reproduced, stored in a retrieval system, or transmitted, in any form, or by any means, mechanical, electronic, photocopying, recording, or otherwise, without the prior written permission of OMRON.
2. No patent liability is assumed with respect to the use of the information contained herein. Moreover, because OMRON is constantly striving to improve its high-quality products, the information contained in this manual is subject to change without notice.
3. Every precaution has been taken in the preparation of this manual. Nevertheless, OMRON assumes no responsibility for errors or omissions. Neither is any liability assumed for damages resulting from the use of the information contained in this publication.

Trademarks

- Sysmac and SYSMAC are trademarks or registered trademarks of OMRON Corporation in Japan and other countries for OMRON factory automation products.
- Microsoft, Windows, Excel, Visual Basic, and Microsoft Edge are either registered trademarks or trademarks of Microsoft Corporation in the United States and other countries.
- EtherCAT® is registered trademark and patented technology, licensed by Beckhoff Automation GmbH, Germany.
- ODVA, CIP, CompoNet, DeviceNet, and EtherNet/IP are trademarks of ODVA.
- The SD and SDHC logos are trademarks of SD-3C, LLC. 
- NVIDIA, the NVIDIA logo, GeForce, and the GeForce logo are the trademarks or registered trademarks of NVIDIA Corporation in the USA and other countries.
- AMD Radeon™ is the trademark of Advanced Micro Devices, Inc.
- Celeron, Intel and Intel Core are trademarks of Intel Corporation in the U.S. and / or other countries.
- Git and the Git logo are either registered trademarks or trademarks of Software Freedom Conservancy, Inc., corporate home of the Git Project, in the United States and/or other countries.
- JavaScript® is a trademark or registered trademark of Oracle Corporation and its subsidiaries and affiliates in the United States and other countries.
- EPLAN and EPLAN Electric P8 are registered trademarks of EPLAN GmbH & Co.KG.

Other company names and product names in this document are the trademarks or registered trademarks of their respective companies.

Copyrights

Microsoft product screen shots used with permission from Microsoft.

Introduction

Thank you for purchasing the Sysmac Studio Automation Software.

The Sysmac Studio allows you to use a computer to program and set up Sysmac devices.

This manual describes the operating procedures of the Sysmac Studio mainly for NJ/NX/NY-series Controllers.

Use this manual together with the user's manuals for the other devices that you use.

Intended Audience

This manual is intended for the following personnel, who must also have knowledge of electrical systems (an electrical engineer or the equivalent).

- Personnel in charge of introducing FA systems.
- Personnel in charge of designing FA systems.
- Personnel in charge of installing and maintaining FA systems.
- Personnel in charge of managing FA systems and facilities.

For programming, this manual is intended for personnel who understand the programming language specifications in international standard IEC 61131-3 or Japanese standard JIS B 3503.

Notice

This manual contains information that is necessary to use the Sysmac Studio. Please read and understand this manual before using the Sysmac Studio. Keep this manual in a safe place where it will be available for reference during operation.

Manual Structure

Page Structure

The following page structure is used in this manual.

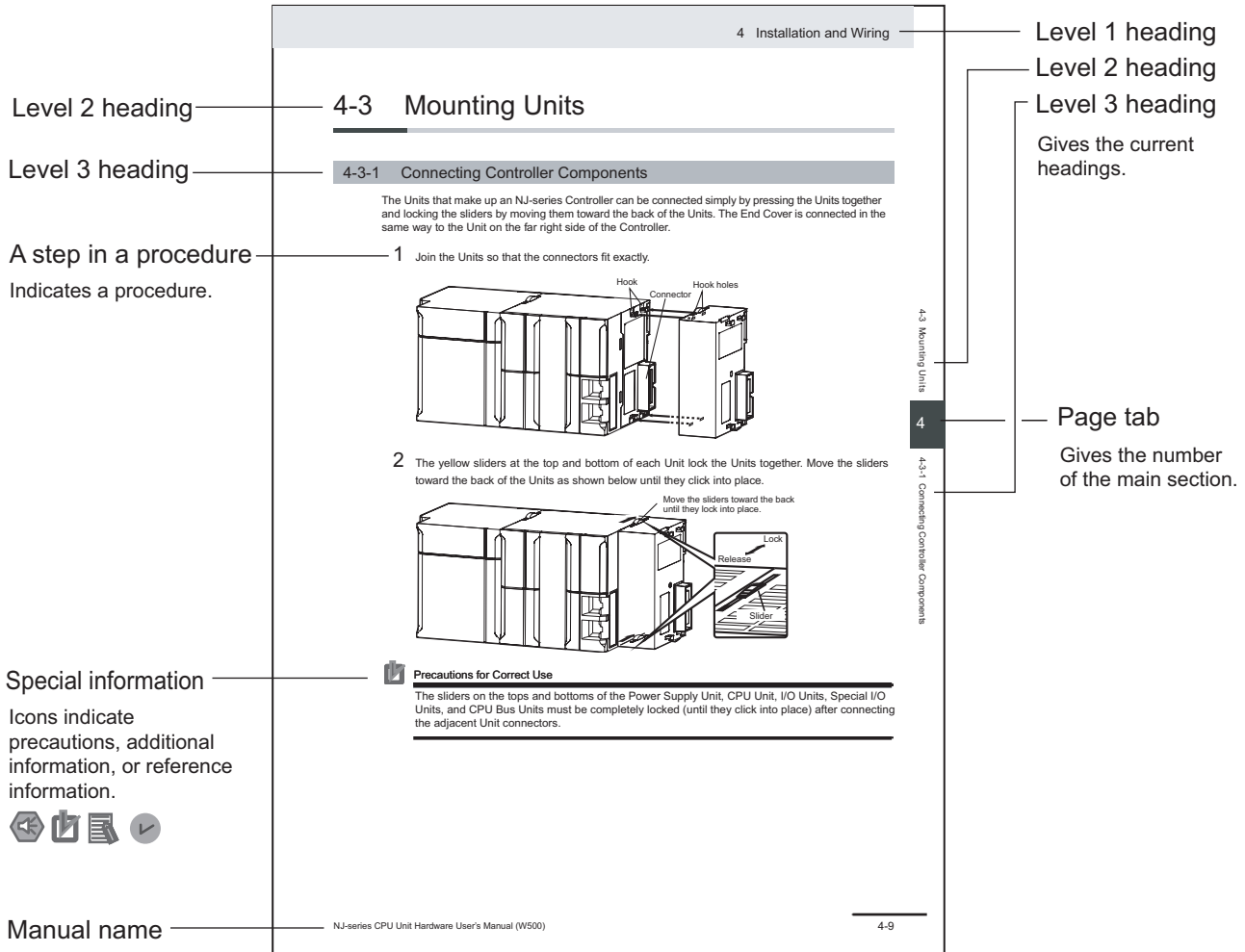

This illustration is provided only as a sample. It may not literally appear in this manual.

Special Information

Special information in this manual is classified as follows:



Precautions for Safe Use

Precautions on what to do and what not to do to ensure safe usage of the product.



Precautions for Correct Use

Precautions on what to do and what not to do to ensure proper operation and performance.



Additional Information

Additional information to read as required.

This information is provided to increase understanding or make operation easier.



Version Information

Information on differences in specifications and functionality for Controllers and Units with different unit versions and for different versions of Support Software is given.

Precaution on Terminology

- For descriptions of the CPU Unit and Controller terms that are used in this manual, refer to information on terminology in the *NJ/NX-series CPU Unit Software User's Manual (Cat. No. W501)* or the *NY-series Industrial Panel PC / Industrial Box PC Software User's Manual (Cat. No. W558)*.
- In this manual, *download* refers to transferring data from the Sysmac Studio to the physical Controller and *upload* refers to transferring data from the physical Controller to the Sysmac Studio. For the Sysmac Studio, *synchronization* is used to both *upload* and *download* data. Here, *synchronize* means to automatically compare the data for the Sysmac Studio on the computer with the data in the physical Controller and transfer the data in the direction that is specified by the user.
- In this manual, the functions of a specific model of the NX-series CPU Units/Controllers may be described with its model specified, such as "NX701 CPU Unit/Controller" or "NX1P2 CPU Unit/Controller".
- In this manual, the Controller functions that are integrated in the NY-series Industrial PC may be referred to as an *NY-series Controller*.
- The Sysmac Studio supports the NJ/NX/NY-series Controllers. Unless another Controller series is specified, the operating procedures and screen captures used in the manual are examples for the NJ-series Controllers.

Terminology

For descriptions of the Controller terms that are used in this manual, refer to information on terminology in the manuals that are listed in *Related Manuals* on page 30.

Sections in this Manual

1	Introduction	10	Support Software Provided with the Sysmac Studio	1	10
2	Installation and Uninstallation	11	Troubleshooting	2	11
3	System Design	A	Appendices	3	A
4	Programming	I	Index	4	I
5	Controller Configurations and Setup			5	
6	Online Connections to a Controller			6	
7	Debugging			7	
8	Other Functions			8	
9	Reusing Programming			9	

CONTENTS

Introduction	1
Intended Audience	1
Notice	1
Manual Structure	2
Page Structure	2
Special Information	2
Precaution on Terminology	3
Terminology	3
Sections in this Manual	5
Terms and Conditions Agreement.....	15
Safety Precautions.....	17
Definition of Precautionary Information.....	17
Symbols	17
Precautions for Safe Use	21
Precautions for Correct Use	24
Regulations and Standards	25
Software Licenses and Copyrights	25
IEC 61131-3 Compliance Statement.....	25
Versions	26
Checking Versions	26
Unit Versions and Sysmac Studio Versions.....	29
Related Manuals.....	30
Revision History.....	39

Section 1 Introduction

1-1 The Sysmac Studio.....	1-2
1-2 Features	1-3
1-3 Specifications.....	1-4
1-3-1 Product Model Numbers	1-4
1-3-2 Support Software That You Can Install from the Sysmac Studio Installer and Enclosed Data ...	1-6
1-3-3 Supported Languages	1-6
1-3-4 Applicable Models	1-7
1-3-5 Types of Licenses	1-8
1-3-6 Applicable Computers	1-9
1-4 Components	1-12

Section 2 Installation and Uninstallation

2-1 Installing the Sysmac Studio	2-2
2-1-1 Confirmations before Installation.....	2-2

2-1-2	Requirements for Installation	2-2
2-1-3	Installing the Sysmac Studio	2-3
2-2	Uninstalling the Sysmac Studio	2-12
2-2-1	Uninstalling the Sysmac Studio	2-12
2-3	Auto-updating the Sysmac Studio	2-16
2-3-1	Confirmations before Implementing Auto-updating	2-16
2-3-2	Implementing an Auto-update	2-16

Section 3 System Design

3-1	Basic Flow of System Design 1	3-3
3-2	Basic Flow of System Design 2	3-6
3-3	Creating a Project	3-9
3-3-1	Starting and Exiting the Sysmac Studio	3-9
3-3-2	Creating a Project File	3-11
3-3-3	Closing a Project File and Returning to the Start Page	3-16
3-3-4	Saving the Project File	3-17
3-3-5	Saving a Project File Under a Different Name	3-17
3-3-6	Opening a Project File	3-18
3-3-7	Exporting a Project File	3-19
3-3-8	Importing a Project File	3-21
3-3-9	Password Protection for Project Files	3-22
3-3-10	Project Update History Management	3-25
3-3-11	Creating a Project from an Online Connection	3-28
3-3-12	Displaying and Registering Licenses	3-28
3-3-13	Project Version Control	3-29
3-3-14	Project File Management Mode	3-30
3-4	Parts of the Window	3-32
3-4-1	Application Window	3-32
3-4-2	Multiview Explorer (1)	3-33
3-4-3	Edit Pane (3)	3-36
3-4-4	Toolbox (4)	3-41
3-4-5	Changing the Display Location of Window Parts	3-44
3-4-6	Saving and Restoring the Window Layout	3-48
3-5	Menu Command Structure	3-52
3-6	Basic Editing Operations	3-59
3-7	Sysmac Studio Settings and Operations	3-62
3-7-1	Setting Parameters	3-62
3-7-2	Programming	3-68
3-7-3	Library Functions	3-71
3-7-4	Project Management	3-72
3-7-5	Debugging	3-73
3-7-6	Simulation	3-75
3-7-7	Monitoring Information	3-76
3-7-8	Communications	3-77
3-7-9	Maintenance	3-77
3-7-10	Security Measures	3-78
3-7-11	Customizing Function	3-79
3-7-12	Window Operation	3-80
3-7-13	Online Help	3-80
3-7-14	OPC UA Functions	3-81
3-7-15	Function Specifications of DB Connection Function	3-82
3-7-16	CNC Functions	3-82
3-7-17	EtherNet/IP Connection Settings	3-83
3-7-18	EtherNet/IP Slave Terminal Settings	3-83
3-7-19	PROFINET Slave Terminal Settings	3-84
3-7-20	Function Specifications of Safety Control Units	3-85
3-7-21	Function Specifications of NA-series Programmable Terminals	3-90
3-7-22	Vision Sensor Functions	3-96

3-7-23	Displacement Sensor Functions	3-103
3-7-24	Team Development Option.....	3-104
3-7-25	3D Simulation Function	3-105
3-7-26	Robot Function.....	3-106
3-7-27	Application Manager Function.....	3-109
3-7-28	Automation Playback Function.....	3-113

Section 4 Programming

4-1	Variable Registration	4-3
4-1-1	Creating Global Variables.....	4-4
4-1-2	Creating Device Variables.....	4-11
4-1-3	Creating Local Variables	4-22
4-1-4	Creating Axis Variables	4-27
4-1-5	Creating Axes Group Variables	4-30
4-1-6	Creating Cam Data Variables	4-32
4-1-7	Creating Function Block Instance Variables	4-35
4-1-8	System-defined Variables.....	4-36
4-1-9	Entering Variable Attributes.....	4-36
4-1-10	Variable Manager	4-48
4-2	Registering POUs	4-57
4-2-1	Displaying POUs	4-57
4-2-2	Registering Programs	4-57
4-2-3	Registering Function Blocks.....	4-60
4-2-4	Registering Functions	4-62
4-2-5	Copying, Pasting, and Deleting Multiple POUs	4-64
4-3	Creating Data Types	4-69
4-4	Namespaces	4-79
4-4-1	Data for Which You Can Use Namespaces	4-79
4-4-2	Setting Namespaces	4-79
4-4-3	Using Namespaces	4-82
4-5	Programming Ladder Diagrams	4-85
4-5-1	Opening and Using the Ladder Editor	4-85
4-5-2	Adding and Deleting Sections	4-86
4-5-3	Basic Ladder Editor Operations	4-90
4-5-4	Editing Variables and Data Types in the Ladder Editor	4-112
4-5-5	Operating Functions and Function Blocks in the Ladder Editor	4-117
4-5-6	Element Comments and Rung Comments.....	4-135
4-5-7	Inserting and Deleting Jump Labels and Jumps	4-138
4-5-8	Customizing the View.....	4-141
4-5-9	Ladder Editor Guide	4-142
4-5-10	Ladder Editor Shortcut Key List	4-145
4-5-11	Rung Pattern Copy.....	4-146
4-6	Programming Structured Text	4-152
4-6-1	Starting the ST Editor.....	4-152
4-6-2	Basic ST Editor Operations.....	4-153
4-6-3	Editing Variables and Data Types in the ST Editor.....	4-158
4-6-4	Operating Functions and Function Blocks in the ST Editor.....	4-162
4-6-5	Customizing the View.....	4-165
4-7	Comparison before Pasting Dependents	4-166
4-7-1	Comparison before Pasting Dependents Dialog Box	4-166
4-7-2	Detailed Comparison Window	4-167
4-8	Searching and Replacing	4-168
4-8-1	Scope of Searching and Replacing.....	4-168
4-8-2	Search and Replace Pane	4-168
4-8-3	Items to Set	4-169
4-8-4	Searching	4-172
4-8-5	Replacing	4-173
4-8-6	Searching All	4-174

4-8-7	Replacing All	4-174
4-8-8	Replacing All N.O. and N.C. Inputs	4-174
4-9	Program Checks	4-175
4-9-1	Check All Programs	4-175
4-9-2	Check Selected Programs	4-175
4-10	Building and Rebuilding.....	4-178
4-11	Offline Comparison.....	4-180
4-11-1	Procedure for Offline Comparison.....	4-180
4-11-2	Printing Offline Comparison Results	4-184
4-11-3	Merging Detailed Comparison Results.....	4-187

Section 5 Controller Configurations and Setup

5-1	Overview of Controller Configurations and Setup	5-3
5-2	EtherCAT Configuration and Setup.....	5-4
5-2-1	Procedure to Open the EtherCAT Tab Page	5-4
5-2-2	Registering Slaves Offline to Configure EtherCAT	5-4
5-2-3	Registering Slaves Online to Configure EtherCAT	5-6
5-2-4	Setting Master Parameters	5-8
5-2-5	Setting Slave Parameters	5-9
5-2-6	Exporting Slave Settings	5-15
5-2-7	Installing and Uninstalling ESI Files	5-17
5-2-8	Transferring the Network Configuration Information	5-18
5-2-9	Exporting EtherCAT Network Configuration Information	5-19
5-2-10	Printing an EtherCAT Configuration	5-23
5-2-11	Starting Vision Sensor or Displacement Sensor Setup.....	5-23
5-3	EtherCAT Slave Terminal Configuration and Setup	5-25
5-3-1	Creating the EtherCAT Slave Terminal Configuration	5-26
5-3-2	Transferring the Slave Terminal Configuration Information	5-34
5-3-3	Exporting the EtherCAT Slave Terminal Configuration Information.....	5-35
5-4	Setting EtherCAT Drives	5-37
5-4-1	Applicable EtherCAT Drives	5-37
5-4-2	Overview of the Structure of the EtherCAT Drive Tab Page.....	5-37
5-4-3	Setting EtherCAT Drives	5-38
5-4-4	Monitoring EtherCAT Drives.....	5-43
5-5	CPU/Expansion Rack Configuration and Setup.....	5-44
5-5-1	CPU/Expansion Racks for the NX502, NX102, or NX1P2 CPU Unit	5-44
5-5-2	CPU Rack and Expansion Racks for NJ-series CPU Units	5-55
5-6	Controller Setup.....	5-65
5-6-1	Operation Settings	5-65
5-6-2	Built-in EtherNet/IP Port Settings	5-71
5-6-3	Built-in I/O Settings	5-77
5-6-4	Option Board Settings	5-77
5-6-5	Memory Settings	5-78
5-7	Motion Control Setup	5-80
5-7-1	Setting Axes	5-80
5-7-2	Exporting and Importing Axis Settings	5-88
5-7-3	Deleting Multiple Axis Settings	5-96
5-7-4	Setting Axes Groups	5-97
5-7-5	Exporting and Importing Axes Group Settings	5-99
5-7-6	Deleting Multiple Axes Group Settings.....	5-103
5-8	Cam Data Settings	5-105
5-8-1	Registering Cam Data Settings	5-105
5-8-2	Editing Cam Data Settings	5-105
5-8-3	Procedure to Transfer Cam Data Settings	5-111
5-8-4	Importing Cam Data Settings	5-111
5-8-5	Exporting Cam Data Settings	5-112

5-8-6	Exporting Cam Tables	5-113
5-8-7	Transferring Cam Tables from the Controller to Files.....	5-114
5-8-8	Transferring Cam Tables from Files to the Controller.....	5-115
5-8-9	Superimposing Cam Tables	5-116
5-8-10	Registering Cam Definitions.....	5-117
5-8-11	Transferring Cam Definitions.....	5-121
5-8-12	Updating Cam Definition Settings	5-123
5-9	Task Settings.....	5-125
5-9-1	Registering Tasks.....	5-125
5-9-2	Procedure to Set Tasks.....	5-125
5-9-3	Task I/O Settings.....	5-126
5-9-4	Program Assignments.....	5-127
5-9-5	Settings for Exclusive Control of Variables in Tasks.....	5-128

Section 6 Online Connections to a Controller

6-1	Overview.....	6-2
6-2	Going Online with a Controller.....	6-3
6-2-1	Overview	6-3
6-2-2	Setting the Connection Method.....	6-5
6-2-3	Going Online	6-6
6-2-4	Going Online after Checking the Connection Method.....	6-7
6-2-5	Going Offline	6-7
6-2-6	Confirming the Serial ID.....	6-8
6-2-7	Checking for Forced Refreshing	6-9
6-2-8	Going Online without a Project.....	6-9

Section 7 Debugging

7-1	Debugging Operations on the Simulator and Controller.....	7-2
7-2	Operations Used for Both Online and Offline Debugging.....	7-4
7-2-1	Monitoring	7-4
7-2-2	Differential Monitor.....	7-21
7-2-3	Changing Present Values and Set/Reset Using Forced Refreshing.....	7-24
7-2-4	Cross References	7-36
7-2-5	Online Editing.....	7-41
7-2-6	Changing the Operating Mode.....	7-45
7-2-7	Monitoring Controller Status.....	7-46
7-2-8	Task Execution Status Monitor.....	7-50
7-2-9	Task Execution Time Monitor	7-50
7-2-10	Axis Status Monitor (MC Monitor Table).....	7-51
7-2-11	Data Tracing.....	7-53
7-2-12	Output Factor Search.....	7-80
7-3	Offline Debugging.....	7-86
7-3-1	Debugging with Program Simulation.....	7-86
7-3-2	Offline Debugging of Sequence and Motion Control Programs	7-106
7-3-3	Offline Debugging for Sequence Control and Vision Sensor	7-109
7-3-4	Offline Debugging for Sequence Control and Displacement Sensor	7-113
7-3-5	Offline Debugging with Sequence Control and NA-series PT Simulator (Simultaneous Simulation of Controller with NA-series PT).....	7-115
7-3-6	Integrated NS-series PT Simulation for Offline Debugging of Sequence Control and NS-series PTs	7-118
7-3-7	Offline Debugging for Sequence Control and Safety CPU Units.....	7-120
7-3-8	3D Simulation.....	7-120
7-3-9	Executing OPC UA Server on the Simulator.....	7-121
7-4	Preparations for Online Debugging.....	7-122
7-4-1	Assigning Variables and Real I/O.....	7-122
7-4-2	Assigning Axis Variables and I/O Devices.....	7-124

7-5	Performing Online Debugging	7-126
7-5-1	Transferring/Comparing Data to/from the Controller	7-127
7-5-2	Testing Axis Operation (MC Test Run)	7-149
7-5-3	Checking I/O Wiring	7-153
7-5-4	Checking I/O Assignments	7-154
7-5-5	Resetting the Controller	7-155
7-5-6	Restarting Units.....	7-156

Section 8 Other Functions

8-1	SD Memory Card Operations	8-4
8-1-1	SD Memory Card Window Procedures	8-4
8-2	Clock Information Settings	8-8
8-3	Security Settings	8-9
8-3-1	Secure Communications Setting	8-9
8-3-2	Operation Authority Verification.....	8-11
8-3-3	User Authentication	8-19
8-3-4	Authentication of User Program Execution IDs	8-34
8-3-5	Write Protection of the CPU Unit.....	8-37
8-3-6	Data Protection	8-39
8-3-7	Secure Socket Settings.....	8-45
8-4	User Memory Usage Monitor	8-49
8-5	Printing	8-52
8-5-1	Items You Can Print	8-52
8-5-2	Print Setup	8-52
8-5-3	Printing	8-55
8-5-4	Print Preview	8-56
8-6	Clearing Memory	8-58
8-6-1	Clearing All Memory of the CPU Unit.....	8-58
8-6-2	Clearing All Memory of X Bus Units	8-60
8-6-3	Clearing All Memory of NX Units.....	8-61
8-6-4	Clear All Memory Operation for the Units in a Slave Terminal	8-62
8-7	Releasing Access Rights	8-64
8-8	Displaying Unit Production Information	8-65
8-8-1	Displaying CPU Unit Production Information	8-65
8-8-2	Displaying EtherCAT Slave Production Information	8-67
8-8-3	Displaying Production Information for Configuration Units in EtherCAT Slave Terminals	8-67
8-9	Firmware Update Log	8-69
8-10	Backup Functions	8-70
8-10-1	Controller Backup Functions	8-71
8-10-2	SD Memory Card Backup Functions.....	8-75
8-10-3	Backing Up Variables and Memory	8-76
8-10-4	Importing/Exporting Backup Files	8-84
8-11	Transferring All Controller Data	8-88
8-11-1	Transferring Data from the Computer to a Controller	8-88
8-11-2	Transferring Data from the Controller to the Computer.....	8-88
8-12	NX Unit Maintenance	8-90
8-13	EtherCAT Maintenance	8-91
8-13-1	Disconnecting a Slave from and Reconnecting a Slave to the Network	8-91
8-13-2	Packet Monitoring	8-93
8-13-3	Diagnostic and Statistical Information	8-94
8-13-4	Maintenance Operations for EtherCAT Slave Terminals	8-99
8-14	Grouping for POUs and Global Variables	8-101
8-14-1	Displaying the Programming Group Tab Page.....	8-101
8-14-2	Grouping POUs.....	8-102
8-14-3	Grouping Global Variables	8-105

8-15 Project Shortcut View	8-109
8-15-1 Displaying the Project Shortcut View	8-109
8-15-2 Adding User Folders	8-110
8-15-3 Renaming User Folders	8-111
8-15-4 Copying and Pasting User Folders	8-111
8-15-5 Cutting User Folders	8-112
8-15-6 Deleting User Folders	8-112
8-15-7 Editing Comments on User Folders	8-113
8-15-8 Adding Shortcuts	8-113
8-15-9 Editing Items from Shortcuts	8-115
8-15-10 Copying and Pasting Shortcuts	8-116
8-15-11 Cutting Shortcuts	8-117
8-15-12 Deleting Shortcuts	8-117
8-15-13 Editing Comments on Shortcuts	8-118
8-15-14 Jumping from a Shortcut to the Multiview Explorer	8-118
8-16 Troubleshooting	8-120
8-16-1 Troubleshooting Dialog Box	8-120
8-16-2 Controller Errors	8-121
8-16-3 Controller Event Log	8-125
8-16-4 User-defined Errors	8-129
8-16-5 User-defined Event Log	8-130
8-16-6 Event Setting Table	8-131
8-16-7 Displaying and Editing the Event Setting Table	8-133
8-16-8 Exporting the Event Setting Table	8-136
8-16-9 Event Log Viewer	8-137
8-17 Changing Variable Comments and Data Type Comments	8-140
8-17-1 Exporting Comments	8-140
8-17-2 Editing the Comment File	8-140
8-17-3 Importing Comment Files	8-141
8-17-4 Switching the Displayed Comments	8-142
8-17-5 Procedure to Edit Switchable Comments in Variable Tables	8-143
8-18 Exporting the Program Hash Code	8-146
8-19 Exporting Global Variables	8-148
8-19-1 Exporting Global Variables for the Network Configurator	8-148
8-19-2 Exporting Global Variables for the CX-Designer	8-148
8-20 Importing ST Programs	8-149
8-21 Importing IEC 61131-10 XML Files	8-151
8-21-1 Importing Data	8-151
8-21-2 Compare before Importing	8-152
8-22 Importing IEC-62714 AutomationML Files	8-155
8-22-1 Importing Data	8-156
8-22-2 Comparison Results of Controller Configurations	8-159
8-22-3 Resolving Conflicts between Device Variables	8-161
8-23 Importing Motor Sizing Tool Results	8-162
8-24 Updating the Configurations and Setup Transfer Data	8-164
8-25 EtherNet/IP Connection Settings	8-165
8-26 Sysmac Studio Option Settings	8-166
8-26-1 Option Settings	8-166
8-26-2 Exporting and Importing Option Settings	8-174

Section 9 Reusing Programming

9-1 Overview	9-2
9-2 Example of Reusing Device and Program Assets	9-4
9-2-1 Changing I/O Assignments	9-4
9-2-2 Deleting Device Options	9-5

9-2-3	Adding Device Options.....	9-6
9-3	Creating and Using Libraries.....	9-8
9-3-1	Creating a Library.....	9-8
9-3-2	Using a Library.....	9-12
9-4	Program Sharing in Derived Devices.....	9-17
9-4-1	Overview of Sharing Programs in Derived Devices.....	9-17
9-4-2	Procedure to Share a Program.....	9-18
9-4-3	Editing Shared Data.....	9-21
9-4-4	Changing a Sharing Relationship.....	9-23

Section 10 Support Software Provided with the Sysmac Studio

10-1	Support Software Provided with the Sysmac Studio.....	10-2
10-2	Starting and Exiting the Support Software.....	10-4
10-2-1	Starting the Support Software Provided with Sysmac Studio.....	10-4
10-2-2	Exiting the Support Software Provided with Sysmac Studio.....	10-4

Section 11 Troubleshooting

11-1	Error Messages for Ladder Program Checks.....	11-2
11-2	Error Messages for Structured Text Checks.....	11-7
11-3	Error Messages for Variable Check.....	11-10
11-4	Error Messages for Sysmac Studio Operation.....	11-11

Appendices

A-1	Driver Installation for Direct USB Cable Connection.....	A-3
A-1-1	Installing the USB Driver.....	A-3
A-1-2	Installing a Specified USB Driver.....	A-3
A-1-3	Installing NA5-□□W□□□□-V2 USB Driver.....	A-5
A-1-4	Confirmation Procedure after Installation.....	A-10
A-2	Specifying One of Multiple Ethernet Interface Cards.....	A-11
A-3	Network Browser Tool.....	A-13
A-4	Differences between the Simulator and the Physical Controller.....	A-15
A-4-1	Operation of Functions.....	A-15
A-4-2	Task Execution.....	A-18
A-4-3	Task Execution Times.....	A-21
A-4-4	Floating-point Data Expressions.....	A-22
A-5	Online Help.....	A-23
A-5-1	Sysmac Studio Help Contents.....	A-23
A-5-2	Instruction Reference.....	A-23
A-5-3	Keyboard Mapping Reference.....	A-24
A-5-4	System Defined Variable Reference.....	A-24
A-6	Shortcut Keys.....	A-25
A-6-1	Basic Operations.....	A-25
A-6-2	Editing Programs.....	A-26
A-6-3	Searching and Replacing.....	A-27
A-6-4	Online.....	A-27
A-6-5	Simulation.....	A-28
A-6-6	SD Memory Card.....	A-28
A-6-7	Changing Shortcut Keys.....	A-29
A-7	Simulation Instructions.....	A-38
A-7-1	Simulate Positive Limit Input Signal Instruction.....	A-38

A-7-2	Simulate Negative Limit Input Signal Instruction	A-39
A-7-3	Simulate Home Proximity Signal Instruction	A-42
A-7-4	Simulate Immediate Stop Input Signal Instruction	A-43
A-7-5	Simulate External Latch Input Signal Instruction	A-44
A-7-6	Simulate Drive Alarm Instruction	A-46
A-7-7	Simulate Drive Warning Instruction	A-47
A-7-8	Encoder Velocity Input Instruction	A-48
A-7-9	Write Actual Position Instruction	A-50
A-7-10	Write Actual Velocity Instruction	A-52
A-7-11	Write Actual Torque Instruction	A-54
A-7-12	Detailed Information on Error Codes	A-56
A-8	Directly Connecting to an EtherCAT Slave Terminal	A-59
A-8-1	Procedure for Directly Connecting to an EtherCAT Slave Terminal	A-59
A-8-2	Transferring Settings for an EtherCAT Slave Terminal	A-60
A-8-3	Comparing the EtherCAT Slave Terminal Configuration Information	A-61
A-8-4	USB Connection Prohibition Setting for EtherCAT Slave Terminals	A-61
A-8-5	I/O Wiring Checks for EtherCAT Slave Terminals	A-62
A-8-6	Differences in Operation from an Online Connection to an NJ/NX/NY-series Controller	A-63
A-9	MDP Settings for EtherCAT Network Slaves	A-64
A-9-1	Installing ESI Files for MDP Slaves	A-64
A-9-2	Adding MDP Slaves	A-64
A-9-3	Editing Module Configurations	A-64
A-9-4	Building Module Configurations Online	A-65
A-9-5	Setting MDP Slaves and Transferring/Comparing Module Configurations	A-65
A-9-6	Displaying Production Information	A-65
A-10	Changing the Sysmac Studio Display Language	A-67
A-10-1	Changing the Display Language	A-67
A-11	Changing models among NJ-, NX-, and NY-series Controllers	A-68
A-11-1	Changing between NJ-series and NX701 Controllers	A-69
A-11-2	Changing between NJ-series and NY-series Controllers	A-70
A-11-3	Changing between NY-series and NX701 Controllers	A-72
A-11-4	Changing between NX1P2 and NJ-series Controllers	A-73
A-11-5	Changing between NX1P2 and NX701 Controllers	A-75
A-11-6	Changing between NX1P2 and NY-series Controllers	A-77
A-11-7	Changing between NX102 and NJ-series Controllers	A-78
A-11-8	Changing between NX102 and NX701 Controllers	A-80
A-11-9	Changing between NX102 and NY-series Controllers	A-81
A-11-10	Changing between NX102 and NX1P2 Controllers	A-83
A-11-11	Changing between NX502 and NJ-series Controllers	A-84
A-11-12	Changing between NX502 and NX701 Controllers	A-86
A-11-13	Changing between NX502 and NY-series Controllers	A-88
A-11-14	Changing between NX502 and NX102 Controllers	A-89
A-11-15	Changing between NX502 and NX1P2 Controllers	A-91
A-12	Report Tools	A-92
A-12-1	Sysmac Controller Log Upload Tool	A-92
A-12-2	Sysmac Studio Error Report Generating Tool	A-94
A-12-3	Sysmac Coupler Log Upload Tool	A-95
A-13	Downloading Manuals	A-97
A-13-1	Displaying the Manual Download Site	A-97

Index

Terms and Conditions Agreement

WARRANTY

- The warranty period for the Software is one year from the date of purchase, unless otherwise specifically agreed.
- If the User discovers defect of the Software (substantial non-conformity with the manual), and return it to OMRON within the above warranty period, OMRON will replace the Software without charge by offering media or download from OMRON's website. And if the User discovers defect of media which is attributable to OMRON and return it to OMRON within the above warranty period, OMRON will replace defective media without charge. If OMRON is unable to replace defective media or correct the Software, the liability of OMRON and the User's remedy shall be limited to the refund of the license fee paid to OMRON for the Software.

LIMITATION OF LIABILITY

- THE ABOVE WARRANTY SHALL CONSTITUTE THE USER'S SOLE AND EXCLUSIVE REMEDIES AGAINST OMRON AND THERE ARE NO OTHER WARRANTIES, EXPRESSED OR IMPLIED, INCLUDING BUT NOT LIMITED TO, WARRANTY OF MERCHANTABILITY OR FITNESS FOR PARTICULAR PURPOSE. IN NO EVENT, OMRON WILL BE LIABLE FOR ANY LOST PROFITS OR OTHER INDIRECT, INCIDENTAL, SPECIAL OR CONSEQUENTIAL DAMAGES ARISING OUT OF USE OF THE SOFTWARE.
- OMRON SHALL HAVE NO LIABILITY FOR DEFECT OF THE SOFTWARE BASED ON MODIFICATION OR ALTERNATION TO THE SOFTWARE BY THE USER OR ANY THIRD PARTY. OMRON SHALL NOT BE RESPONSIBLE AND/OR LIABLE FOR ANY LOSS, DAMAGE, OR EXPENSES DIRECTLY OR INDIRECTLY RESULTING FROM THE INFECTION OF OMRON PRODUCTS, ANY SOFTWARE INSTALLED THEREON OR ANY COMPUTER EQUIPMENT, COMPUTER PROGRAMS, NETWORKS, DATABASES OR OTHER PROPRIETARY MATERIAL CONNECTED THERETO BY DISTRIBUTED DENIAL OF SERVICE ATTACK, COMPUTER VIRUSES, OTHER TECHNOLOGICALLY HARMFUL MATERIAL AND/OR UNAUTHORIZED ACCESS.
- OMRON SHALL HAVE NO LIABILITY FOR SOFTWARE DEVELOPED BY THE USER OR ANY THIRD PARTY BASED ON THE SOFTWARE OR ANY CONSEQUENCE THEREOF.

APPLICABLE CONDITIONS

USER SHALL NOT USE THE SOFTWARE FOR THE PURPOSE THAT IS NOT PROVIDED IN THE ATTACHED USER MANUAL.

CHANGE IN SPECIFICATION

The software specifications and accessories may be changed at any time based on improvements and other reasons.

ERRORS AND OMISSIONS

The information in this manual has been carefully checked and is believed to be accurate; however, no responsibility is assumed for clerical, typographical, or proofreading errors, or omissions.

Safety Precautions

Definition of Precautionary Information

The following notation is used in this manual to provide precautions required to ensure safe usage of the Sysmac Studio and an NJ/NX/NY-series Machine Automation Controller.

The safety precautions that are provided are extremely important to safety. Always read and heed the information provided in all safety precautions.

The following notation is used.



WARNING

Indicates a potentially hazardous situation which, if not avoided, could result in death or serious injury. Additionally, there may be severe property damage.



Caution

Indicates a potentially hazardous situation which, if not avoided, may result in minor or moderate injury, or property damage.



Precautions for Safe Use

Indicates precautions on what to do and what not to do to ensure safe usage of the product.



Precautions for Correct Use

Indicates precautions on what to do and what not to do to ensure proper operation and performance.

Symbols



The circle and slash symbol indicates operations that you must not do. The specific operation is shown in the circle and explained in text. This example indicates *prohibiting disassembly*.



The triangle symbol indicates precautions (including warnings). The specific operation is shown in the triangle and explained in text. This example indicates a *precaution for electric shock*.



The triangle symbol indicates precautions (including warnings). The specific operation is shown in the triangle and explained in text. This example indicates a *general precaution*.



The filled circle symbol indicates operations that you must do. The specific operation is shown in the circle and explained in text. This example shows a *general precaution for something that you must do*.

WARNING

Check the user program for proper execution before you use it for actual operation.



Check the parameters for proper execution before you use them for actual operation.



Always confirm safety at the destination node before you transfer a user program, *configuration data*, *setup data*, device variables, or values in memory used for CJ-series Units from the Sysmac Studio.

The devices or machines may perform unexpected operation regardless of the operating mode of the CPU Unit.



Execute online editing only after you confirm that no adverse effects will be caused to the operation of the master and slave axes if the synchronized control processing time is extended.



Before you perform online editing for a function or a function block, check the locations where the function or function block is used in the Cross Reference Tab Page and confirm the range that will be affected.



Sufficiently confirm safety before you change the values of I/O ports or variables on the I/O Map when the Sysmac Studio is online with the CPU Unit. Incorrect operation may cause the devices that are connected to Output Units to operate regardless of the operating mode of the Controller.



If you set inappropriate parameters when you change the levels of NX Unit events, unexpected machine operation may result. Confirm that the machine will not be adversely affected before you transfer the data.



If you use EtherCAT slaves, check the specifications of those slaves in manuals or other documentation and confirm that the system will not be adversely affected before you transfer parameters.



When you search and replace a string in a project that includes more than one device, make sure that the string to replace is in the data of the intended device before you replace it. If you replace data of an unintended device, the controlled system may cause an unexpected operation.



To prevent computer viruses, install antivirus software on a computer where you use this software. Make sure to keep the antivirus software updated.



Keep your computer's OS updated to avoid security risks caused by a vulnerability in the OS.



Always use the highest version of this software to add new features, increase operability, and enhance security.



Manage usernames and passwords for this software carefully to protect them from unauthorized uses.



Set up a firewall (E.g., disabling unused communication ports, limiting communication hosts, etc.) on a network for a control system and devices to separate them from other IT networks. Make sure to connect to the control system inside the firewall.



Use a virtual private network (VPN) for remote access to a control system and devices from this software.



To prevent information leaks and falsification due to unauthorized login to the computer, configure the account settings appropriately.



Caution

Although the Simulator simulates the operation of the Controller, there are difference from the Controller in operation and timing.
After you debug the user program on the Simulator, always check operation on the physical Controller before you use the user program to operate the controlled system.
Accidents may occur if the controlled system performs unexpected operation.



The Simulator instructions are not processed on the physical Controller and all outputs from the instructions will be FALSE. After you debug the user program on the Simulator, always check operation on the physical Controller before you use the user program to operate the controlled system.
Accidents may occur if the controlled system performs unexpected operation.



Simultaneous simulation for offline debugging of sequences and the HMI can be performed to simulate the linked operation of the Controller and HMI. However, there are differences in the operation and timing between this simulation and the actual combination of the HMI and Controller. After you debug operation with the simulation, always check operation on the physical Controller and HMI before you use them in the actual system.
Accidents may occur if the controlled system performs unexpected operation.



Sufficiently confirm safety before you change the values of variables online. Incorrect operation may cause the devices that are connected to Output Units to operate regardless of the operating mode of the Controller.



Always confirm safety before you reset the Controller or any components.



Always confirm the safety at the destination node before you transfer a user program to a node or perform an operation that changes device variables.
Not doing so may result in injury.



Sufficiently confirm safety before you change the values of variables on a Watch Tab Page when the Sysmac Studio is online with the CPU Unit. Incorrect operation may cause the devices that are connected to Output Units to operate regardless of the operating mode of the Controller.



Sufficiently confirm safety at the connected slave or Unit before you change the value of an I/O port or device variable.
Not doing so may result in injury.



Always confirm safety at the destination node before you transfer parameters or data from the Sysmac Studio to another node.
Not doing so may result in injury.



Precautions for Safe Use

Operation

- Confirm that the controlled system will not be adversely affected before you perform any of the following operations.
 - a) Changing the operating mode of the CPU Unit (including changing the Startup Mode).
 - b) Changing the user program or settings.
 - c) Changing set values or present values.
 - d) Performing forced refreshing.
- Before you restart operation, make sure that the required data, including device variables, the user program, and parameters, is transferred to a CPU Unit, Special I/O Unit, CPU Bus Unit, or externally connected device that was replaced.
- Before you restart the EtherNet/IP Unit, make sure that doing so will not adversely affect the controlled system.
- Before executing Clear All Memory in X Bus Unit, make sure that doing so will not adversely affect the controlled system.
- When you restore only part of the data that was backed up, confirm that no problems will occur if you do not restore all of the backup data. Otherwise, malfunction of the device may occur.
- If you transfer only selected programs from the programs that did not match for the synchronization function, there is no way to check on the Sysmac Studio the integrity with the programs that you do not transfer. After you transfer the programs, confirm safety before you change the CPU Unit to RUN mode.

EtherCAT Communications

- If verifying revisions is not selected in the **Revision Check Method** parameter in the master settings in EtherCAT configuration, parameters are also transferred to slaves with different revisions. If an incompatible revision of a slave is connected, incorrect parameters may be set and operation may not be correct. If you disable the revision check, make sure that only compatible slaves are connected before transferring the parameters.
- Unexpected operation may result if you transfer inappropriate network configuration settings. Even if appropriate network configuration settings are set, confirm that the controlled system will not be adversely affected before you transfer the data.
- After you transfer the user program, the CPU Unit is restarted and communications with the EtherCAT slaves are cut off. During that period, the slave outputs behave according to the slave specifications. The time that communications are cut off depends on the EtherCAT network configuration. Before you transfer the user program, confirm that the system will not be adversely affected.
- NX bus communications are not always established immediately after the power supply is turned ON. Use the system-defined variables and the EtherCAT Coupler Unit device variables in the user program to confirm that communications are established before attempting control operations.

Slave Terminals

- If any inappropriate parameters are set when you transfer the following settings, unexpected machine operation may result. Confirm that the machine will not be adversely affected before you transfer the data. Also, confirm that the Unit configuration, I/O allocations, and Unit operation settings are correctly set in the Slave Terminal before you start actual operation.
 - a) Communications Coupler Unit and NX Unit settings
 - b) Node address and Unit number settings for the Communications Coupler Unit and NX Units
 - c) I/O allocation settings for the Communications Coupler Unit and NX Units
- If inappropriate Unit configuration information is transferred to the Slave Terminal, unexpected machine operation may result. Even if appropriate Unit configuration information is set, confirm that the controlled system will not be adversely affected before you transfer the data.
- If you execute communications instructions for NX Units with inappropriate path information, unexpected machine operation may result. Confirm that the path information is correct before you start actual operation.
- After you import Communications Coupler Unit and NX Unit settings, confirm that the Unit configuration, I/O allocations, and Unit operation settings are correctly set in the Slave Terminal before you start actual operation.
- If inappropriate backup data is set when you restore backup data to a Unit, unexpected machine operation may result. Confirm that the system will not be adversely affected before you transfer the data.
- Do not disconnect the cable when you change the values of I/O ports or variables from the I/O Map with a direct connection to the EtherCAT Coupler Unit. To connect directly to a different Coupler Unit, go offline, connect the cable to the other Unit, and go online again.

MC Test Run

- Confirm the axis number carefully before you perform an MC Test Run.
- An MC Test Run operation involves motor operation. Refer to the operation manual before you execute an MC Test Run.

Be particularly careful of the following points.

 - a) Confirm safety around all moving parts.
 - b) When you click the Run Button, the motor begins actual operation at the specified velocity. Only begin motor operation if you are absolutely sure there is no danger if you start the motor.
 - c) Always have an external emergency stop device available.
 - d) Sometimes you may be unable to stop the motor from your computer. Install an external emergency stop device so that you can stop the motor immediately if needed.
 - e) Only operate the motor when you can clearly confirm the motor operation so that you can react quickly in the case of any danger that may arise due to operation of the motor.
 - f) A communications error will occur if you attempt to begin operations without EtherCAT communications. Always establish EtherCAT communications first.
- Precautions during MC Test Run Operation
 - a) During test run execution, only the Sysmac Studio has any control of the operation. Any commands from motion control instructions are ignored.
 - b) If communications are interrupted between the Sysmac Studio and Controller during test run operations, you will not be able to stop the motor from the computer. Provide an external hardware means that you can use to stop the motor without fail.

Motion Control

- The absolute encoder home offsets are stored in the Controller and backed up by a Battery as absolute encoder information. If any of the following conditions is met, clear the absolute encoder home offsets from the list of data items to restore, and then restore the data. Then, define home again. If you do not define home, unintended operation of the controlled system may occur.
 - a) The Servomotor or Servo Drive was changed since the data was backed up.
 - b) The absolute encoder was set up after the data was backed up.
 - c) The absolute data for the absolute encoder was lost.
- If you change the detailed settings of the **Axis Basic Settings** Tab Page, make sure that the device or machine performs the expected operation before you start actual operation. If the relationship between the functions of the Motion Control Function Module and the EtherCAT slave process data that is assigned to the axes is not correct, the device or machine may perform unexpected operation.

Unit Replacement

- The performance may be different if the hardware revisions are different. Before you transfer the user program, data, and parameter settings to the CPU Units with the different hardware revisions, check them for proper execution and then use them for actual operation.

Model Change

- If the configuration of the EtherCAT network includes an EtherCAT slave that cannot be used by the Controllers after model change, the configuration and settings of the EtherCAT network will be all cleared. In that case, create and set an EtherCAT network configuration again.

Precautions for Correct Use

- Observe the following precautions when you start the Sysmac Studio or any of the Support Software that is provided with it.
 - a) Exit all applications that are not necessary to use the Sysmac Studio. For virus checker or other software that could affect the startup and operations of the Sysmac Studio, take measures such as to remove the Sysmac Studio from the scope of virus checking.
 - b) If any hard disks or printers that are connected to the computer are shared with other computers on a network, isolate them so that they are no longer shared.
 - c) With some notebook computers, the default settings assign the USB port to a modem or infrared communications.
Refer to the user documentation for your computer and set the USB port as a normal serial port.
 - d) With some notebook computers, the default settings do not supply power to the USB port or Ethernet port to save energy. There are energy-saving settings in Windows, and also sometimes in utilities or the BIOS of the computer. Refer to the user documentation for your computer and disable all energy-saving features.
- No checks are made to verify the logical consistency between data items in the Special Unit Setup. Therefore, always check the logical consistency between all settings before transferring the Special Unit Setup to the NJ-series Controller and starting operation, especially when you perform tasks such as enabling or disabling a setting from another setting. Depending on the settings, logical inconsistencies could result in unintended operation.
For example, assume that setting item 1 specifies either *standard settings* or *custom settings* and that the custom settings start from setting item 2. Here, even if you set the custom settings from item 2 onward, the *setting* of setting item 1 will not be automatically changed to specify using the *custom settings*. In this case, if you do not also change the *setting* of setting item 1 to specify using the *custom settings*, the settings from items 2 onward will be ignored.

Regulations and Standards

Software Licenses and Copyrights

- This product incorporates certain third party software. The license and copyright information associated with this software is available at http://www.fa.omron.co.jp/nj_info_e/.
- This software uses knowledge media technology that was developed by the Meme Media Laboratory (VBL) of Hokkaido University.

IEC 61131-3 Compliance Statement

This product conforms to the IEC 61131-3 standards.

Refer to the *IEC 61131-3 compliance statement* (http://www.fa.omron.co.jp/nj_info_e/) for information on items that are in compliance with these standards.

Versions

Hardware revisions and unit versions are used to manage the hardware and software in NJ/NX-series Units, NY-series Industrial PCs, and EtherCAT slaves. The hardware revision or unit version is updated each time there is a change in hardware or software specifications. Even when two Units or EtherCAT slaves have the same model number, they will have functional or performance differences if they have different hardware revisions or unit versions.

This section describes NJ/NX-series CPU Units, NY-series Industrial PCs, and EtherCAT slaves as examples.

Checking Versions

You can check versions on the ID information indications or with the Sysmac Studio.

Checking Unit Versions on ID Information Indications

The unit version is given on the ID information indication on the side of the product. The ID information on an NX-series NX701-□□□□ CPU Unit is shown below.

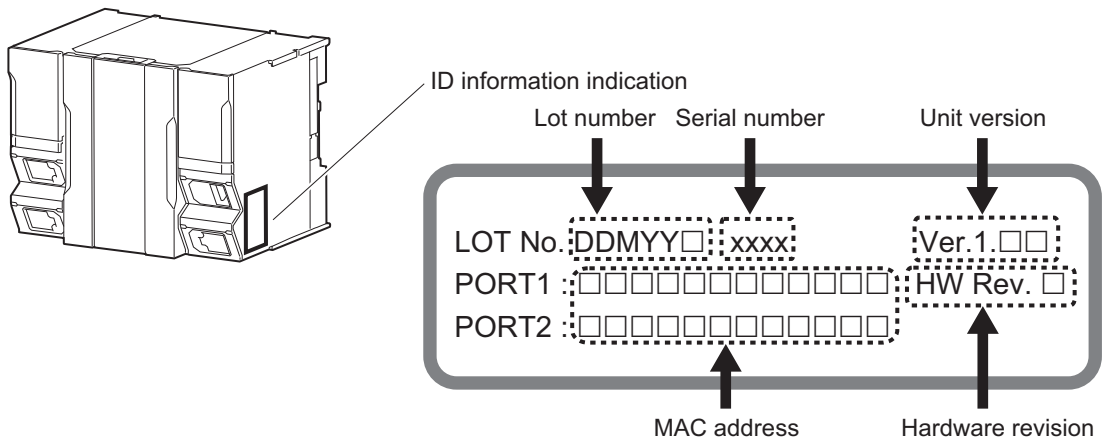

Note The hardware revision is not displayed for the Unit that the hardware revision is in *blank*.

The ID information on an NX-series NX1P2-□□□□□□ CPU Unit is shown below.

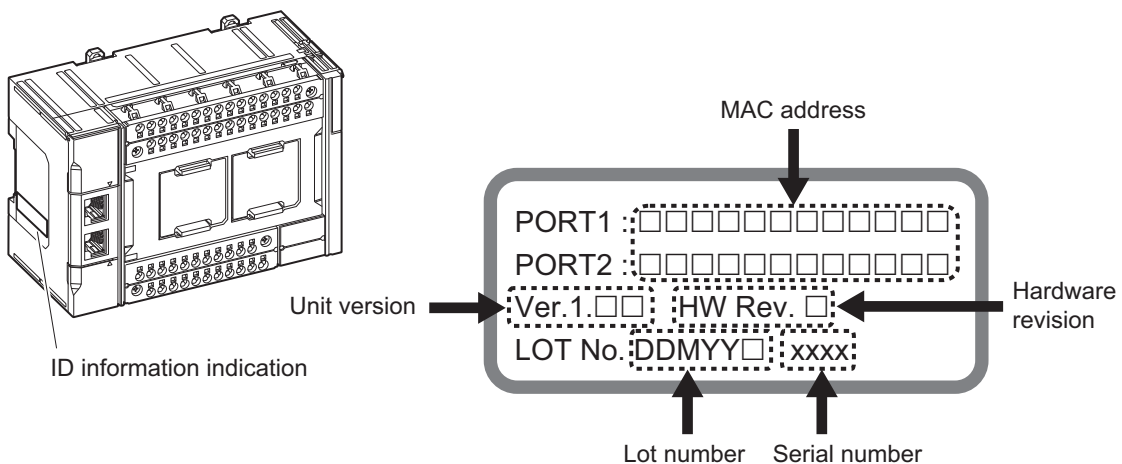

Note The hardware revision is not displayed for the Unit that the hardware revision is in *blank*.

The ID information on an NJ-series NJ501-□□□□ CPU Unit is shown below.

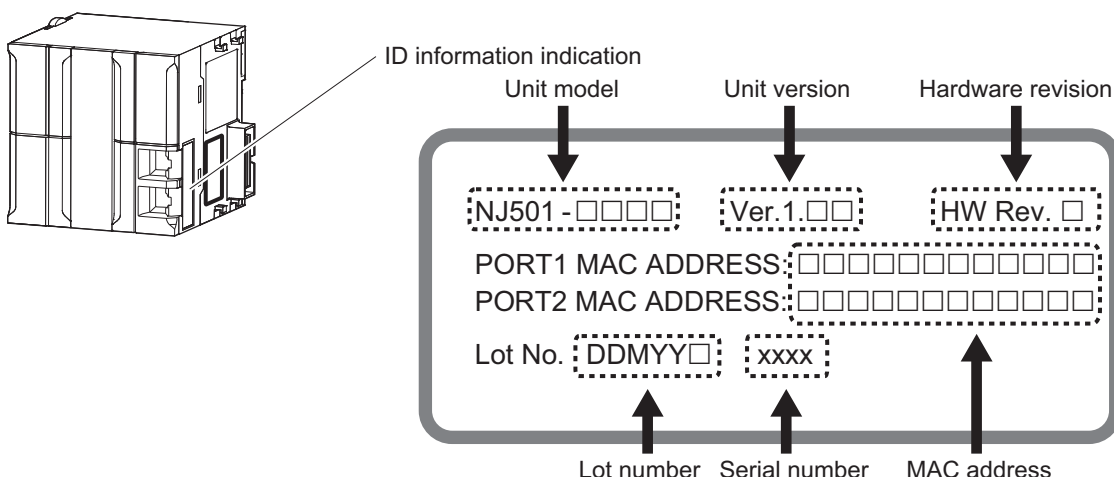

Note The hardware revision is not displayed for the Unit that the hardware revision is in *blank*.

The unit version of the NY-series Industrial PC is given on the ID information indication on the back of the product.

The ID information on an NY-series NY5□2-□□□□ Controller is shown below.

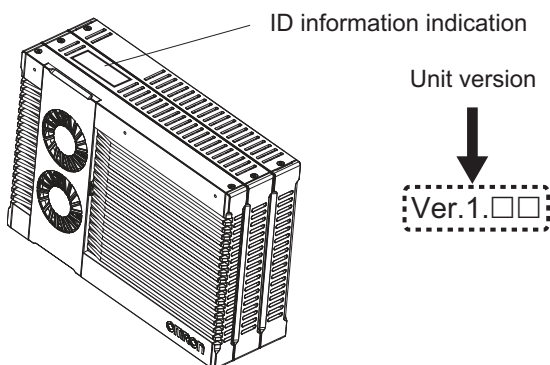

Checking Unit Versions with the Sysmac Studio

You can use the **Production Information** Dialog Box while the Sysmac Studio is online to check the unit version of a Unit.

You can check the unit version of the following Units and Controllers.

- NJ/NX-series CPU Units or NY-series Controllers
- CJ-series Special I/O Units and CPU Bus Units
- EtherCAT slaves

The unit versions of CJ-series Basic I/O Units cannot be checked from the Sysmac Studio.

Refer to the *8-8 Displaying Unit Production Information* on page 8-65 for details on the Unit production information displays.

● NX-series CPU Units and NY-series Controllers

- 1 Right-click **CPU Rack** under **Configurations and Setup – CPU/Expansion Racks** in the Multiview Explorer and select **Display Production Information**.

The **Production Information** Dialog Box is displayed.

The unit version is displayed after **Ver.** to the right of the Unit model number or Controller model number.

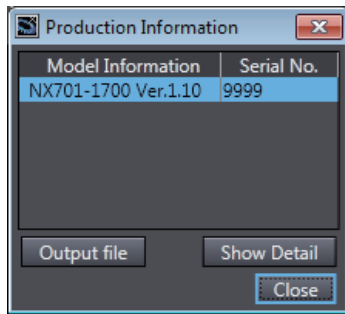

● NJ-series CPU Units and CJ-series Units

- 1 Double-click **CPU/Expansion Racks** under **Configurations and Setup** in the Multiview Explorer. Or, right-click **CPU/Expansion Racks** under **Configurations and Setup** and select **Edit** from the menu.
The Unit Editor is displayed.
- 2 Right-click any open space in the Unit Editor and select **Production Information**.
The **Production Information** Dialog Box is displayed.
The unit version is displayed after *Ver.* to the right of the Unit model number.

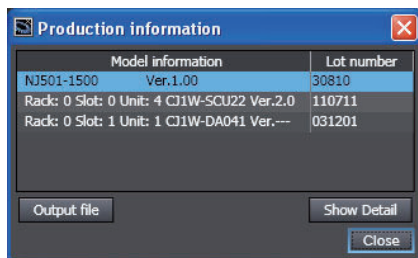

● EtherCAT Slaves

- 1 Double-click **EtherCAT** under **Configurations and Setup** in the Multiview Explorer. Or, right-click **EtherCAT** under **Configurations and Setup** and select **Edit** from the menu.
The EtherCAT Tab Page is displayed.
- 2 Right-click the master on the EtherCAT Tab Page and select **Display Production Information**.
The Production Information Dialog Box is displayed.
The unit version is displayed after *Rev.* to the right of the Unit model number.

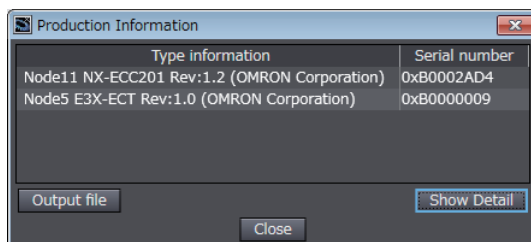



Additional Information

- Refer to the manual for the specific Unit for the unit versions of the CPU Units to which the database connection service and other functions were added, as well as for the unit versions of the Communications Coupler Units, NX Units, and Safety Control Units.
 - This manual sometimes refers to the unit version of the CPU Unit as the *unit version of the Controller*.
-

Unit Versions and Sysmac Studio Versions

The functions that are supported by a Unit depend on its unit version. The version of Sysmac Studio that supports the functions that were added for an upgrade is required to use those functions.

Refer to the *NJ/NX-series CPU Unit Software User's Manual (Cat. No. W501)* and *NY-series Industrial Panel PC / Industrial Box PC Software User's Manual (Cat. No. W558)* for the relationship between the unit versions of the NJ/NX-series CPU Units and the NY-series Industrial PCs and the Sysmac Studio versions, and for the functions that are supported by each unit version.

Refer to the relevant manuals for the Communications Coupler Units, X Bus Units, and NX Units for differences in the functional support provided by each unit version.

Related Manuals

The following manuals are related. Use these manuals for reference.

Manual name	Cat. No.	Model numbers	Application	Description
Sysmac Studio Version 1 Operation Manual	W504	SYSMAC -SE2□□□	Learning about the operating procedures and functions of the Sysmac Studio.	Describes the operating procedures of the Sysmac Studio.
Sysmac Studio Drive Functions Operation Manual	I589	SYSMAC-SE2□□ □ SYSMAC-DE□□ □L	Learning about the Servo Drive related functions of the Sysmac Studio.	Describes the Servo Drive related operating procedures and functions among those of the Sysmac Studio.
Sysmac Studio Project Version Control Function Operation Manual	W589	SYSMAC-SE2□□ □ SYSMAC-TA4□□ □	Learning about the Sysmac Studio project version control function and its operating procedures.	Provides an introduction to the Sysmac Studio project version control function along with its installation method, basic operations, execution method for the main functions, and other information.
Sysmac Studio 3D Simulation Function Operation Manual	W618	SYSMAC-SE2□□ □ SYSMAC-SA4□□ □-64	Learning about an outline of the 3D simulation function of the Sysmac Studio and how to use the function.	Describes an outline, execution procedures, and operating procedures for the 3D simulation function of the Sysmac Studio.
Sysmac Studio Robot Integrated System Building Function with Robot Integrated CPU Unit Operation Manual	W595	SYSMAC-SE2□□ □ SYSMAC-SE200D-64	Learning about the operating procedures and functions of the Sysmac Studio to configure Robot Integrated System using Robot Integrated CPU Unit.	Describes the operating procedures of the Sysmac Studio for Robot Integrated CPU Unit.
Sysmac Studio Robot Integrated System Building Function with IPC Application Controller Operation Manual	W621	SYSMAC-SE2□□ □ SYSMAC-SE200D-64	Learning about the operating procedures and functions of the Sysmac Studio to configure Robot Integrated System using IPC Application Controller.	Describes the operating procedures of the Sysmac Studio for IPC Application Controller.
CX-Integrator CS/CJ/CP/NSJ/NJ-series Network Configuration Tool Operation Manual	W464	---	Learning how to configure networks (data links, routing tables, Communications Unit settings, etc.).	Describes operating procedures for the CX-Integrator.
CX-Designer User's Manual	V099	---	Learning to create screen data for NS-series Programmable Terminals.	Describes operating procedures for the CX-Designer.

Manual name	Cat. No.	Model numbers	Application	Description
CX-Protocol Operation Manual	W344	---	Creating data transfer protocols for general-purpose devices connected to CJ-series Serial Communications Units.	Describes operating procedures for the CX-Protocol.
NX-series CPU Unit Hardware User's Manual	W535	NX701-□□□□	Learning the basic specifications of the NX701 CPU Units, including introductory information, designing, installation, and maintenance. Mainly hardware information is provided.	An introduction to the entire NX701 system is provided along with the following information on the CPU Unit. <ul style="list-style-type: none"> • Features and system configuration • Introduction • Part names and functions • General specifications • Installation and wiring • Maintenance and inspection
NX-series NX502 CPU Unit Hardware User's Manual	W629	NX502-□□□□	Learning the basic specifications of the NX502 CPU Units, including introductory information, designing, installation, and maintenance. Mainly hardware information is provided.	An introduction to the entire NX502 system is provided along with the following information on the CPU Unit. <ul style="list-style-type: none"> • Features and system configuration • Introduction • Part names and functions • General specifications • Installation and wiring • Maintenance and inspection
NX-series NX102 CPU Unit Hardware User's Manual	W593	NX102-□□□□	Learning the basic specifications of the NX102 CPU Units, including introductory information, designing, installation, and maintenance. Mainly hardware information is provided.	An introduction to the entire NX102 system is provided along with the following information on the CPU Unit. <ul style="list-style-type: none"> • Features and system configuration • Introduction • Part names and functions • General specifications • Installation and wiring • Maintenance and inspection
NX-series NX1P2 CPU Unit Hardware User's Manual	W578	NX1P2-□□□□	Learning the basic specifications of the NX1P2 CPU Units, including introductory information, designing, installation, and maintenance. Mainly hardware information is provided.	An introduction to the entire NX1P2 system is provided along with the following information on the CPU Unit. <ul style="list-style-type: none"> • Features and system configuration • Introduction • Part names and functions • General specifications • Installation and wiring • Maintenance and inspection

Manual name	Cat. No.	Model numbers	Application	Description
NJ-series CPU Unit Hardware User's Manual	W500	NJ501-□□□□ NJ301-□□□□ NJ101-□□□□	Learning the basic specifications of the NJ-series CPU Units, including introductory information, designing, installation, and maintenance. Mainly hardware information is provided.	An introduction to the entire NJ-series system is provided along with the following information on the CPU Unit. <ul style="list-style-type: none"> • Features and system configuration • Introduction • Part names and functions • General specifications • Installation and wiring • Maintenance and inspection
NJ/NX-series CPU Unit Software User's Manual	W501	NX701-□□□□ NX502-□□□□ NX102-□□□□ NX1P2-□□□□ NJ501-□□□□ NJ301-□□□□ NJ101-□□□□	Learning how to program and set up an NJ/NX-series CPU Unit. Mainly software information is provided.	The following information is provided on a Controller built with an NJ/NX-series CPU Unit. <ul style="list-style-type: none"> • CPU Unit operation • CPU Unit features • Initial settings • Programming based on IEC 61131-3 language specifications
NX-series NX1P2 CPU Unit Built-in I/O and Option Board User's Manual	W579	NX1P2-□□□□	Learning about the details of functions only for an NX-series NX1P2 CPU Unit and an introduction of functions for an NJ/NX-series CPU Unit.	Of the functions for an NX1P2 CPU Unit, the following information is provided. <ul style="list-style-type: none"> • Built-in I/O • Serial Communications Option Boards • Analog I/O Option Boards An introduction of following functions for an NJ/NX-series CPU Unit is also provided. <ul style="list-style-type: none"> • Motion control functions • EtherNet/IP communications functions • EtherCAT communications functions
NJ/NX-series Instructions Reference Manual	W502	NX701-□□□□ NX502-□□□□ NX102-□□□□ NX1P2-□□□□ NJ501-□□□□ NJ301-□□□□ NJ101-□□□□	Learning detailed specifications on the basic instructions of an NJ/NX-series CPU Unit.	The instructions in the instruction set (IEC 61131-3 specifications) are described.
NJ/NX-series CPU Unit Motion Control User's Manual	W507	NX701-□□□□ NX502-□□□□ NX102-□□□□ NX1P2-□□□□ NJ501-□□□□ NJ301-□□□□ NJ101-□□□□	Learning about motion control settings and programming concepts.	The settings and operation of the CPU Unit and programming concepts for motion control are described.

Manual name	Cat. No.	Model numbers	Application	Description
NJ/NX-series Motion Control Instructions Reference Manual	W508	NX701-□□□□ NX502-□□□□ NX102-□□□□ NX1P2-□□□□ NJ501-□□□□ NJ301-□□□□ NJ101-□□□□	Learning about the specifications of the motion control instructions.	The motion control instructions are described.
NJ/NX-series CPU Unit Built-in EtherCAT® Port User's Manual	W505	NX701-□□□□ NX502-□□□□ NX102-□□□□ NX1P2-□□□□ NJ501-□□□□ NJ301-□□□□ NJ101-□□□□	Using the built-in EtherCAT port on an NJ/NX-series CPU Unit.	Information on the built-in EtherCAT port is provided. This manual provides an introduction and provides information on the configuration, features, and setup.
NJ/NX-series CPU Unit Built-in EtherNet/IP™ Port User's Manual	W506	NX701-□□□□ NX502-□□□□ NX102-□□□□ NX1P2-□□□□ NJ501-□□□□ NJ301-□□□□ NJ101-□□□□	Using the built-in EtherNet/IP port on an NJ/NX-series CPU Unit.	Information on the built-in EtherNet/IP port is provided. Information is provided on the basic setup, tag data links, and other features.
NJ/NX-series CPU Unit OPC UA User's Manual	W588	NX701-□□□□ NX502-□□□□ NX102-□□□□ NJ501-1□00	Using the OPC UA.	Describes the OPC UA.
NX-series CPU Unit FINS Function User's Manual	W596	NX701-□□20 NX502-□□□□ NX102-□□□□	Using the FINS function of an NX-series CPU Unit.	Describes the FINS function of an NX-series CPU Unit.
NX-series CPU Unit Automation Playback User's Manual	W639	NX502-□□□□	Using automation playback	Describes automation playback.
NJ/NX-series Database Connection CPU Units User's Manual	W527	NX701-□□20 NX502-□□□□ NX102-□□20 NJ501-□□20 NJ101-□□20	Using the database connection service with NJ/NX-series Controllers.	Describes the database connection service.
NJ-series SECS/GEM CPU Units User's Manual	W528	NJ501-1340	Using the GEM Services with NJ-series Controllers.	Provides information on the GEM Services.
NJ-series NJ Robotics CPU Unit User's Manual	W539	NJ501-4□□□ NJ501-R□□□	Controlling robots with NJ-series CPU Units.	Describes the functionality to control robots.
NJ/NY-series NC Integrated Controller User's Manual	O030	NJ501-5300 NY532-5400	Performing numerical control with NJ/NY-series Controllers.	Describes the functionality to perform the numerical control.
NJ-series Robot Integrated CPU Unit User's Manual	O037	NJ501-R□□□	Using the NJ-series Robot Integrated CPU Unit.	Describes the settings and operation of the CPU Unit and programming concepts for OMRON robot control.

Manual name	Cat. No.	Model numbers	Application	Description
NJ/NX-series Troubleshooting Manual	W503	NX701-□□□□ NX502-□□□□ NX102-□□□□ NX1P2-□□□□ NJ501-□□□□ NJ301-□□□□ NJ101-□□□□	Learning about the errors that may be detected in an NJ/NX-series Controller.	Concepts on managing errors that may be detected in an NJ/NX-series Controller and information on individual errors are described.
NY-series IPC Machine Controller Industrial Panel PC Hardware User's Manual	W557	NY532-□□□□	Learning the basic specifications of the NY-series Industrial Panel PCs, including introductory information, designing, installation, and maintenance. Mainly hardware information is provided.	An introduction to the entire NY-series system is provided along with the following information on the Industrial Panel PC. <ul style="list-style-type: none"> • Features and system configuration • Introduction • Part names and functions • General specifications • Installation and wiring • Maintenance and inspection
NY-series IPC Machine Controller Industrial Box PC Hardware User's Manual	W556	NY512-□□□□	Learning the basic specifications of the NY-series Industrial Box PCs, including introductory information, designing, installation, and maintenance. Mainly hardware information is provided.	An introduction to the entire NY-series system is provided along with the following information on the Industrial Box PC. <ul style="list-style-type: none"> • Features and system configuration • Introduction • Part names and functions • General specifications • Installation and wiring • Maintenance and inspection
NY-series IPC Machine Controller Industrial Panel PC / Industrial Box PC Setup User's Manual	W568	NY532-□□□□ NY512-□□□□	Learning about initial setting of the NY-series Industrial PCs and preparations to use Controllers.	The following information is provided on an introduction to the entire NY-series system. <ul style="list-style-type: none"> • Two OS systems • Initial settings • Industrial PC Support Utility • NYCompolet • Industrial PC API • Backup and recovery
NY-series IPC Machine Controller Industrial Panel PC / Industrial Box PC Software User's Manual	W558	NY532-□□□□ NY512-□□□□	Learning how to program and set up the Controller functions of an NY-series Industrial PC.	The following information is provided on the NY-series Controller functions. <ul style="list-style-type: none"> • Controller operation • Controller features • Controller settings • Programming based on IEC 61131-3 language specifications

Manual name	Cat. No.	Model numbers	Application	Description
NY-series Instructions Reference Manual	W560	NY532-□□□□ NY512-□□□□	Learning detailed specifications on the basic instructions of an NY-series Industrial PC.	The instructions in the instruction set (IEC 61131-3 specifications) are described.
NY-series IPC Machine Controller Industrial Panel PC / Industrial Box PC Motion Control User's Manual	W559	NY532-□□□□ NY512-□□□□	Learning about motion control settings and programming concepts of an NY-series Industrial PC.	The settings and operation of the Controller and programming concepts for motion control are described.
NY-series Motion Control Instructions Reference Manual	W561	NY532-□□□□ NY512-□□□□	Learning about the specifications of the motion control instructions of an NY-series Industrial PC.	The motion control instructions are described.
NY-series IPC Machine Controller Industrial Panel PC / Industrial Box PC Built-in EtherCAT® Port User's Manual	W562	NY532-□□□□ NY512-□□□□	Using the built-in EtherCAT port in an NY-series Industrial PC.	Information on the built-in EtherCAT port is provided. This manual provides an introduction and provides information on the configuration, features, and setup.
NY-series IPC Machine Controller Industrial Panel PC / Industrial Box PC Built-in EtherNet/IP™ Port User's Manual	W563	NY532-□□□□ NY512-□□□□	Using the built-in EtherNet/IP port in an NY-series Industrial PC.	Information on the built-in EtherNet/IP port is provided. Information is provided on the basic setup, tag data links, and other features.
NY-series Troubleshooting Manual	W564	NY532-□□□□ NY512-□□□□	Learning about the errors that may be detected in an NY-series Industrial PC.	Concepts on managing errors that may be detected in an NY-series Controller and information on individual errors are described.
NX-series EtherNet/IP™ Unit User's Manual	W627	NX-EIP201	Learning how to use the NX-series EtherNet/IP Unit.	Information on the NX-series EtherNet/IP Unit is provided. Information is provided on the basic setup, tag data links, and other features.
NX-series EtherCAT® Coupler Unit User's Manual	W519	NX-ECC□□□	Learning how to use an NX-series EtherCAT Coupler Unit and EtherCAT Slave Terminals.	The following items are described: the overall system and configuration methods of an EtherCAT Slave Terminal (which consists of an NX-series EtherCAT Coupler Unit and NX Units), and information on hardware, setup, and functions to set up, control, and monitor NX Units through EtherCAT.

Manual name	Cat. No.	Model numbers	Application	Description
NX-series EtherNet/IP™ Coupler Unit User's Manual	W536	NX-EIC□□□	Learning how to use an NX-series EtherNet/IP Coupler Unit and EtherNet/IP Slave Terminals.	The following items are described: the overall system and configuration methods of an EtherNet/IP Slave Terminal (which consists of an NX-series EtherNet/IP Coupler Unit and NX Units), and information on hardware, setup, and functions to set up, control, and monitor NX Units.
NX-series PROFINET Coupler Unit User's Manual	W623	NX-PNC202	Learning how to use an NX-series PROFINET Coupler Unit and PROFINET Slave Terminals.	The following items are described: the overall system and configuration methods of an PROFINET Slave Terminal (which consists of an NX-series PROFINET Coupler Unit and NX Units), and information on hardware, setup, and functions to set up, control, and monitor NX Units.
NX-series Data Reference Manual	W525	NX-□□□□□□	Referencing lists of the data that is required to configure systems with NX-series Units.	Lists of the power consumptions, weights, and other NX Unit data that is required to configure systems with NX-series Units are provided.
NX-series NX Units User's Manual	W521	NX-ID□□□□ NX-IA□□□□ NX-OC□□□□ NX-OD□□□□ NX-MD□□□□	Learning how to use NX Units.	Describe the hardware, setup methods, and functions of the NX Units. Manuals are available for the following Units. Digital I/O Units, Analog I/O Units, System Units, Position Interface Units, Communications Interface Units, Load Cell Input Units, and IO-Link Master Units.
	W522	NX-AD□□□□ NX-DA□□□□		
	W592	NX-HAD□□□		
	W566	NX-TS□□□□ NX-HB□□□□		
	W523	NX-PD1□□□ NX-PF0□□□ NX-PC0□□□ NX-TBX□□		
	W524	NX-EC0□□□ NX-ECS□□□ NX-PG0□□□		
	W540	NX-CIF□□□		
	W565	NX-RS□□□□		
	W567	NX-ILM□□□		
	Z401	NX-V680C□		
	H228	NX-TC□□□□		
	H238	NX-HTC□□□□		
	W626	NX-ECT□□□		
	W647	NX-CT□□□		
NX-series Safety Control Unit User's Manual	Z930	NX-SL□□□□ NX-SI□□□□ NX-SO□□□□	Learning how to use NX-series Safety Control Units.	Describes the hardware, setup methods, and functions of the NX-series Safety Control Units.

Manual name	Cat. No.	Model numbers	Application	Description
NX-series Safety Control Unit / Communication Control Unit User's Manual	Z395	NX-SL5□□□ NX-SI□□□□ NX-SO□□□□ NX-CSG□□□	Learning how to use the NX-series Safety Control Units and Communication Control Units.	Describes the hardware, setup methods, and functions of the NX-series Safety Control Units and Communication Control Units.
NX-series Communication Control Unit Built-in Function User's Manual	Z396	NX-CSG□□□	Learning about the built-in functions of an NX-series Communication Control Unit.	Describes the software setup methods and communication functions of an NX-series Communication Control Unit.
Vision Sensor FQ-M-series Specialized Vision Sensor for Positioning User's Manual	Z314	FQ-MS12□	Learning how to use the Specialized Vision Sensors for Positioning.	Describes the hardware, setup methods and functions of the Specialized Vision Sensors for Positioning.
Vision System FH/FHV Series Operation Manual for Sysmac Studio	Z343	FH-1□□□ FH-1□□□-□□ FH-2□□□ FH-2□□□-□□ FH-3□□□ FH-3□□□-□□ FH-5□□□ FH-5□□□-□□ FHV7□-□□□□□- C FHV7□-□□□□□- S□□ FHV7□-□□□□□- S□□-□□ FHV7□-□□□□□- H□□ FHV7□-□□□□□- H□□-□□	Learning about the setting procedures for FH-series and FHV-series Vision Sensors.	Describes the Sysmac Studio setting procedures for FH-series and FHV-series Vision Sensors.
Displacement Sensor ZW-series Confocal Fiber Type Displacement Sensors User's Manual	Z332	ZW-CE1□	Learning how to use the ZW-series Displacement Sensors.	Describes the hardware, setup methods and functions of the ZW-series Displacement Sensors.
ZW-7000/5000-series Confocal Fiber Type Displacement Sensor User's Manual	Z362	ZW-7000□ ZW-5000□	Learning the setting procedures for ZW-7000/5000-series Displacement Sensors.	Describes the Sysmac Studio setting procedures for ZW-7000/5000-series Displacement Sensors.
ZW-7000/5000-series Confocal Fiber Type Displacement Sensor User's Manual for Communication Settings	Z363	ZW-7000□ ZW-5000□	Learning the communication setting procedures for ZW-7000/5000-series Displacement Sensors.	Describes the Sysmac Studio setting procedures for ZW-7000/5000-series Displacement Sensors.

Manual name	Cat. No.	Model numbers	Application	Description
NA-series Programmable Terminal Hardware User's Manual	V117	NA5-□□W□□□□	Learning the specifications and settings required to install an NA-series Programmable Terminals and connect peripheral devices.	Information is provided on NA-series Programmable Terminal specifications, part names, installation procedures, and procedures to connect an NA Unit to peripheral devices. Information is also provided on maintenance after operation and troubleshooting.
NA-series Programmable Terminal Hardware(-V1) User's Manual	V125	NA5-□□W□□□□ □-V1	Learning the specifications and settings required to install an NA-series Programmable Terminals and connect peripheral devices.	Information is provided on NA-series Programmable Terminal specifications, part names, installation procedures, and procedures to connect an NA Unit to peripheral devices. Information is also provided on maintenance after operation and troubleshooting.
NA-series Programmable Terminal Hardware(-V2) User's Manual	V128	NA5-□□W□□□□ □-V2	Learning the specifications and settings required to install an NA-series PT and connect peripheral devices.	Information is provided on NA-series Programmable Terminal specifications, part names, installation procedures, and procedures to connect an NA Unit to peripheral devices. Information is also provided on maintenance after operation and troubleshooting.
NA-series Programmable Terminal Software User's Manual	V118	NA5-□□W□□□□ (-V□)	Learning about NA-series PT pages and object functions.	Describes the pages and object functions of the NA-series Programmable Terminals.
NA-series Programmable Terminal Device Connection User's Manual	V119	NA5-□W□□□□	Learning the methods to connect NA-series PT with each device.	Describes how to connect NA-series PT with other devices.
NA-series Programmable Terminal Soft-NA User's Manual	V126	NA-RTL□□□□	Learning the basic use of Soft-NA and the differences from NA-series PT.	Describes the basic use of Soft-NA and the differences from NA-series PT.

Revision History

A manual revision code appears as a suffix to the catalog number on the front and back covers of the manual.

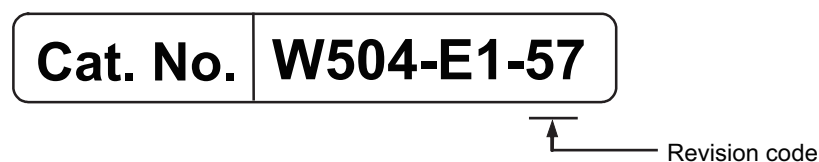

Revision code	Date	Revised content
24	April 2018	<ul style="list-style-type: none"> Japanese catalog number was changed. Revisions for an upgrade to Sysmac Studio version 1.23.
25	July 2018	<ul style="list-style-type: none"> Revisions for an upgrade to Sysmac Studio version 1.24.
26	October 2018	<ul style="list-style-type: none"> Revisions for an upgrade to Sysmac Studio version 1.25.
27	January 2019	<ul style="list-style-type: none"> Revisions for an upgrade to Sysmac Studio version 1.26.
28	April 2019	<ul style="list-style-type: none"> Revisions for an upgrade to Sysmac Studio version 1.27.
29	July 2019	<ul style="list-style-type: none"> Revisions for an upgrade to Sysmac Studio version 1.29.
30	October 2019	<ul style="list-style-type: none"> Revisions for an upgrade to Sysmac Studio version 1.30.
31	January 2020	<ul style="list-style-type: none"> Revisions for an upgrade to Sysmac Studio version 1.31 and the support of Sysmac Studio (64 bit).
32	April 2020	<ul style="list-style-type: none"> Revisions for an upgrade to Sysmac Studio version 1.40.
33	July 2020	<ul style="list-style-type: none"> Revisions for an upgrade to Sysmac Studio version 1.41.
34	August 2020	<ul style="list-style-type: none"> Revisions for an upgrade to Sysmac Studio version 1.42.
35	October 2020	<ul style="list-style-type: none"> Revisions for an upgrade to Sysmac Studio version 1.43.
36	January 2021	<ul style="list-style-type: none"> Revisions for an upgrade to Sysmac Studio version 1.44.
37	April 2021	<ul style="list-style-type: none"> Revisions for an upgrade to Sysmac Studio version 1.45.
38	July 2021	<ul style="list-style-type: none"> Revisions for an upgrade to Sysmac Studio version 1.46.
39	October 2021	<ul style="list-style-type: none"> Revisions for an upgrade to Sysmac Studio version 1.47.
40	April 2022	<ul style="list-style-type: none"> Revisions for an upgrade to Sysmac Studio version 1.49.
41	July 2022	<ul style="list-style-type: none"> Revisions for an upgrade to Sysmac Studio version 1.50.
42	August 2022	<ul style="list-style-type: none"> Revisions for adding safety precautions regarding security.
43	October 2022	<ul style="list-style-type: none"> Revisions for an upgrade to Sysmac Studio version 1.52.
44	November 2022	<ul style="list-style-type: none"> Revisions for an upgrade to Sysmac Studio version 1.52.1.
45	January 2023	<ul style="list-style-type: none"> Revisions for an upgrade to Sysmac Studio version 1.53.
46	April 2023	<ul style="list-style-type: none"> Revisions for an upgrade to Sysmac Studio version 1.54.
47	July 2023	<ul style="list-style-type: none"> Revisions for an upgrade to Sysmac Studio version 1.55.
48	October 2023	<ul style="list-style-type: none"> Revisions for an upgrade to Sysmac Studio version 1.56.
49	January 2024	<ul style="list-style-type: none"> Revisions for an upgrade to Sysmac Studio version 1.57.
50	April 2024	<ul style="list-style-type: none"> Revisions for an upgrade to Sysmac Studio version 1.58.
51	July 2024	<ul style="list-style-type: none"> Revisions for an upgrade to Sysmac Studio version 1.59.
52	October 2024	<ul style="list-style-type: none"> Revisions for an upgrade to Sysmac Studio version 1.60.
53	January 2025	<ul style="list-style-type: none"> Revisions for an upgrade to Sysmac Studio version 1.61.
54	April 2025	<ul style="list-style-type: none"> Revisions for an upgrade to Sysmac Studio version 1.62.
55	July 2025	<ul style="list-style-type: none"> Revisions for an upgrade to Sysmac Studio version 1.63.

Revision code	Date	Revised content
56	October 2025	• Revisions for an upgrade to Sysmac Studio version 1.64.
57	January 2026	• Revisions for an upgrade to Sysmac Studio version 1.65.

1

Introduction

This section provides an overview and lists the specifications of the Sysmac Studio and describes its features and components.

1-1	The Sysmac Studio	1-2
1-2	Features	1-3
1-3	Specifications	1-4
1-3-1	Product Model Numbers.....	1-4
1-3-2	Support Software That You Can Install from the Sysmac Studio In- staller and Enclosed Data	1-6
1-3-3	Supported Languages	1-6
1-3-4	Applicable Models	1-7
1-3-5	Types of Licenses.....	1-8
1-3-6	Applicable Computers	1-9
1-4	Components	1-12

1-1 The Sysmac Studio

The Sysmac Studio Automation Software provides an integrated development environment to set up, program, debug, and maintain SYSMAC NJ/NX/NY-series Controllers and other Machine Automation Controllers, as well as EtherCAT slaves.

Flexible Development Environment

The Sysmac Studio provides an environment for programming with variables.

There is no need for concern about memory addresses. This eliminates the need to wait for memory address definitions for hardware before the start of software development. Hardware and software can be designed independently and developed in parallel.

POUs (program organization units) that include programs, functions, and function blocks can be used to design programming that does not depend on any one specific system. This increases the reusability of programming.

Development Environment for Multiple Programmers

The Sysmac Studio provides an environment for programming with variables and POUs.

Programming is designed with POUs (programs, functions, and function blocks). The programs are then assigned to tasks and the program execution order is defined. This reduces the interdependence of the programs and therefore allows more than one programmer to easily work at the same time.

The assignments of variables to hardware and the definitions of the relations between information that is shared between different programs can be set at any time.

1-2 Features

More Support for IEC 61131-3 Programming Languages

The Sysmac Studio is based on the International Standard IEC 61131-3. It provides a state-of-the-art programming environment based on the ladder diagram and structured text programming languages and on POUs, which include programs, functions, and function blocks.

Easy Operation

The Sysmac Studio places as few restrictions as possible on the design procedures to allow you to start design work from any part of the system. The design concept features easy-to-understand operating procedures with suitable guides that do not interfere with the workflow so that you can see the flow of design work.

This provides user-friendly operation for flexible design work in which even mistakes in settings and procedures can be corrected immediately or left until the project is finalized as long as they will not lead to serious accidents. The Sysmac Studio is designed to achieve optimum functionality and ease of operation to combine Machine Automation Controllers, such as those in the NJ/NX/NY Series, with Sysmac-compliant EtherCAT slaves and other Sysmac devices.

Complete Debugging

The Sysmac Studio provides complete functions for debugging sequence control, such as changing present values and changing programming online. It also provides debugging functions with motion control simulations of motion control, such as displaying trace results in 2D or 3D and displaying traces on virtual devices. These functions enable debugging on images that are closer to the physical devices.

Also, debugging through Vision System simulation with a Vision Sensor is supported. With the Vision Edition, you can perform simulation for individual Vision Sensors. With the Standard Edition, you can also perform integrated simulation with a Controller.

Maintenance

The Sysmac Studio lets you check the Controller status on a status list. Troubleshooting functions let you easily check error details and corrections for Controller errors.

You can also assign user-defined errors in the same way as Controller errors are assigned.

1-3 Specifications

1-3-1 Product Model Numbers

To use the Sysmac Studio, you need to install the software and purchase a license. Please download the software from the License Portal site (64-bit application only) or purchase the DVD media.

There are two types of licenses: the network license for 64-bit application and the standalone license for 32-bit application.

The network license for 64-bit application requires you to register your user ID, license number, and computer in the system on the Internet for authentication. This eliminates the risk of losing the license and enables authentication, cancellation, and transfer of the license.

The standalone license (for 32-bit application) is a type of license that can be used by entering the license number at the startup of the Sysmac Studio. It is suitable for multi-user operation or bundling with a maintenance computer as a component of manufacturing equipment.

Network License (for 64-bit Application Only)

After purchasing a network license, you can download the installer image file for installation by signing up as a user on the License Portal site. Visit our website at <https://license-user.automation.omron.com/> for details.

Product name	Number of licenses	Model number
Sysmac Studio basic license	1 license	SYSMAC-BA201L
Sysmac Studio advanced license	1 license	SYSMAC-AD201L
Sysmac Studio upgrade license for advanced*1	1 license	SYSMAC-AD501L

*1. This license upgrades your basic license to the advanced license.

DVD

Product	32-bit/64-bit application	Model number
Sysmac Studio Standard Edition	32-bit application	SYSMAC-SE200D
Version 1.□□	64-bit application	SYSMAC-SE200D-64

You can also download the installer image file for installation of the Sysmac Studio (64 bit) by signing up as a user on the License Portal site.

Visit our website at <https://license-user.automation.omron.com/> for details.

Standalone License

Product	Number of licenses	Model number
Sysmac Studio Standard Edition Version 1.□□	1 license	SYSMAC-SE201L
	3 licenses	SYSMAC-SE203L
	10 licenses	SYSMAC-SE210L
	30 licenses	SYSMAC-SE230L
	50 licenses	SYSMAC-SE250L
Sysmac Studio Vision Edition* ¹ Version 1.□□	1 license	SYSMAC-VE001L
Sysmac Studio Measurement Edition* ² Version 1.□□	1 license	SYSMAC-ME001L
	3 licenses	SYSMAC-ME003L
Sysmac Studio NX-IO Edition* ³ Version 1.□□	1 license	SYSMAC-NE001L
Sysmac Studio Drive Edition* ⁴ Version 1.□□	1 license	SYSMAC-DE001L
Sysmac Studio Safety Edition* ⁵ Version 1.□□	1 license	SYSMAC-FE0□□L

- *1. You can use the Vision Edition only for the FQ-M-series Vision Sensors and FH-series Vision Sensors.
- *2. With the Measurement Edition, you can use only the setup functions for ZW-series Displacement Sensors.
- *3. You can use the NX-IO Edition only for EtherNet/IP Slave Terminals that use an NX-series EtherNet/IP Coupler Unit or PROFINET Coupler Unit.
- *4. You can use the Drive Edition only for 1S-series and G5-series Servo Drives.
- *5. You can use the Safety Edition only for safety control systems that use an NX-series Communication Control Unit or NX-series EtherNet/IP Coupler.

Option Licenses for Standalone License

You must purchase an option license to use the functions supported by the option. To use an option license, register it after you install the Sysmac Studio.

Option licenses cannot be applied to the network license.

To use functionality equivalent to those listed below with the network license, please purchase a Sysmac Studio advanced license (SYSMAC-AD201L) or a Sysmac Studio upgrade license for advanced (SYSMAC-AD501L).

Product name	Number of licenses	Model number
Sysmac Studio Team Development Option* ¹	1 license	SYSMAC-TA401L
	3 licenses	SYSMAC-TA403L
	10 licenses	SYSMAC-TA410L
	30 licenses	SYSMAC-TA430L
	50 licenses	SYSMAC-TA450L

Product name	Number of licenses	Model number
Sysmac Studio	1 license	SYSMAC-SA401L-64
3D Simulation Option* ²	3 licenses	SYSMAC-SA403L-64
	10 licenses	SYSMAC-SA410L-64
	30 licenses	SYSMAC-SA430L-64
	50 licenses	SYSMAC-SA450L-64

*1. Refer to the *Sysmac Studio Project Version Control Function Operation Manual (Cat. No. W589)* for details on the Team Development Option.

*2. Refer to the *Sysmac Studio 3D Simulation Function Operation Manual (Cat. No. W618)* for details on the 3D simulation option.

1-3-2 Support Software That You Can Install from the Sysmac Studio Installer and Enclosed Data

The following table lists the Support Software that you can install from the Sysmac Studio installer and the data that is included on the DVD.

Installable Software	Version	Classification	Enclosed data
• Sysmac Studio	Ver. 1.□	Automation Software	• CPS • Manuals (PDF files)
• CX-Integrator* ¹	Ver. 2.□	Support Software	
• CX-Designer* ¹	Ver. 3.□	Support Software	
• CX-Protocol* ¹	Ver. 2.□	Support Software	
• Network Configurator* ¹	Ver. 3.□	Support Software	
• CX-ConfiguratorFDT* ¹	Ver. 3.□	Support Software	
• Adept Robot IP Address Setting Tool	Ver. 1.□	Support Software	
• CX-Server* ¹	Ver. 5.□	Communication Middleware	
• Communications Middleware	Ver. 1.□	Communication Middleware	

*1. This software cannot be installed from the Sysmac Studio Vision Edition, Measurement Edition, or Drive Edition.

Refer to *10-1 Support Software Provided with the Sysmac Studio* on page 10-2 for information on Support Software.

1-3-3 Supported Languages

The Sysmac Studio supports the following languages.

Japanese, English, German, French, Italian, Spanish, Traditional Chinese, Simplified Chinese, and Korean

1-3-4 Applicable Models

The models that you can select when you create a project on the Sysmac Studio are given in the following tables.

Controllers

Model numbers
NX701-16□□
NX701-17□□
NX502-13□□
NX502-14□□
NX502-15□□
NX502-16□□
NX502-17□□
NJ501-13□□
NJ501-14□□
NJ501-15□□
NJ501-43□□
NJ501-44□□
NJ501-45□□
NJ501-53□□
NJ501-R□□□*1
NJ301-11□□
NJ301-12□□
NJ101-10□□
NJ101-90□□

*1. Supported by the Sysmac Studio (64-bit) only.

Displacement Sensors

Model numbers
ZW-CE1□
ZW-CE1□T
ZW-C1□
ZW-C1□T
ZW-8000
ZW-8000T
ZW-7000
ZW-7000T
ZW-5000
ZW-5000T

Model numbers
NY532-13□□
NY532-14□□
NY532-15□□
NY532-54□□
NY512-13□□
NY512-14□□
NY512-15□□
NX102-10□□
NX102-11□□
NX102-12□□
NX102-90□□
NX1P2-10□□□□
NX1P2-10□□□□1
NX1P2-11□□□□
NX1P2-11□□□□1
NX1P2-90□□□□
NX1P2-90□□□□1
NX1P2-9B□□□□
NX1P2-9B□□□□1

HMIs

Model numbers
NA5-15W□□□□
NA5-12W□□□□
NA5-9W□□□□
NA5-7W□□□□
NA-RTL□□
NA5-15W□□□□(-V□)
NA5-12W□□□□(-V□)
NA5-9W□□□□(-V□)
NA5-7W□□□□(-V□)

Vision Sensors

Model numbers
FH-1□□□
FH-1□□□-□□
FH-2□□□
FH-2□□□-□□
FH-3□□□
FH-3□□□-□□
FH-5□□□
FH-5□□□-□□
FHV7□-□□□□□-C
FHV7□-□□□□□-S□□
FHV7□-□□□□□-S□□-□□
FHV7□-□□□□□-H□□
FHV7□-□□□□□-H□□-□□
FQ-MS12□-ECT*2
FQ-MS12□-M-ECT*2
FQ-MS12□*2
FQ-MS12□-M*2

*2. Supported by the Sysmac Studio (32-bit) only.

Slave Terminals

Model numbers
NX-EIC□□□
NX-PNC□□□

Drives

Model numbers
R88D-1SN□□□-ECT
R88D-1SN□□□-ECT-51
R88D-1SAN□□□-ECT
R88D-KN□□□-ECT(-L)

Safety Network Controllers

Model numbers
NX-CSG□□□

Application Controllers

Model numbers
AM101-1000*1*2

*1. Supported by the Sysmac Studio (64 bit) only.

*2. Select *Application Manager* when you select a device.



Additional Information

- Some Controllers support OPC UA. Refer to the *NJ/NX-series CPU Unit OPC UA User's Manual (Cat. No. W588)* for details on the OPC UA and the models of the Controllers that support OPC UA.
- The NJ501-□□20, NJ101-□□20, NX701-□□20, NX502-1□00, and NX102-□□20 are Controllers that support DB connection. Refer to the *NJ/NX-series Database Connection CPU Units User's Manual (Cat. No. W527)* for details.
- The NJ501-1340 supports GEM Services. Refer to the *NJ-series SECS/GEM CPU Units User's Manual (Cat. No. W528)* for details.
- The NJ501-4□□□ support robot control. Refer to the *NJ-series NJ Robotics CPU Unit User's Manual (Cat. No. W539)* for details.
- The NJ501-5300 and NY532-5400 are Controllers that support CNC function. Refer to the *NJ/NY-series NC Integrated Controller User's Manual (Cat. No. O030)* for details.
- The NX-CSG□□□ is a Communication Control Unit that is necessary to use the NX-SL5□□□ Safety CPU Unit. Refer to the *NX-series Safety Control Unit / Communication Control Unit User's Manual (Cat. No. Z395)* for details.

Download the PDF files of the manuals from your OMRON website.

1-3-5 Types of Licenses

There are two types of licenses: the network license and the standalone license.

Network License

The network license includes two types of grades.

Grade of license	Description
Basic license	This edition allows you to use all the models that are listed under <i>1-3-4 Applicable Models</i> on page 1-7.
Advanced license	In addition to the functions of the basic license, you can use the 3D simulation option and the team development option functions.

Standalone License

The standalone license includes the following types.

Edition	Description
Standard Edition	This edition allows you to use all the models that are listed under <i>1-3-4 Applicable Models</i> on page 1-7.
Vision Edition	You can use this edition only for FQ-M-series Vision Sensors and FH-series Vision Sensors.
Measurement Edition	You can use this edition only for ZW-series Displacement Sensors.

Edition	Description
NX-IO Edition	You can use this edition only for EtherNet/IP Slave Terminals that use an NX-series EtherNet/IP Coupler Unit or PROFINET Coupler Unit.
Drive Edition	You can use this edition only for 1S-series and G5-series Servo Drives.
Safety Edition	You can use this edition only for safety control systems that use an NX-series Communication Control Unit or NX-series EtherNet/IP Coupler.
Trial Version (without a License)	You can use all of the functions of the Standard Edition for 30 days after you install the software.

You can register more than one license at the same time. The priority of license validity is given in the following table.

Priority	Types of Licenses
1 (high)	Standard Edition
2	Vision Edition Measurement Edition NX-IO Edition Drive Edition Safety Edition
3 (low)	Trial Version

- If licenses with different priorities are registered at the same time, the license with the highest priority is valid.
Example: If you register a license for the Vision Edition when the Trial Version is already installed in the Sysmac Studio, you can use only Vision Sensors. In this case, you cannot use the Trial Version of the Sysmac Studio.
- If licenses with the same priorities are registered at the same time, all of the licenses are valid.
Example: If you register a license for the Vision Edition when a license for the Measurement Edition is already registered in the Sysmac Studio, you can use both Displacement Sensors and Vision Sensors.

Refer to 3-3-12 *Displaying and Registering Licenses* on page 3-28 for the procedure to register licenses.

1-3-6 Applicable Computers

The Sysmac Studio is an application that runs on Microsoft Windows.

The Sysmac Studio comes as either 32-bit or 64-bit applications. The supported OS and system requirements are given in the following table.

System Requirements

The system requirements for the Sysmac Studio are given in the following table.

● For Sysmac Studio (32 bit)

OS	CPU*1	RAM	Display
Windows 7 SP1*2 (32-bit or 64-bit edition)	DOS/V (IBM AT compatible machines) personal computers equipped with Intel® Core™ i5 M520 (2.4 GHz) or equivalent/faster processors are recommended.	2 GB min.	XGA 1,024 × 768, 16 million colors
Windows 8.1*3 (32-bit or 64-bit edition)		4 GB min. recom- mended	WXGA 1,280 × 800, 16 million colors recommended
Windows 10 version 1607 or later (32-bit or 64-bit edition)			
Windows 11 (64-bit edition)			

*1. If you create a user program with a memory size over 20 MB, the personal computer equipped with Intel® Core™ i7 or an equal/faster processor and the RAM of 8 GB or more is recommended.

*2. Windows 7 Update (KB4474419 and KB4490628) must be applied to the OS.

*3. Windows 8.1 Update (KB2919355) must be applied to the OS.

Apply the latest updates to the OS installed on your computer to ensure that it is always up-to-date. In addition, installation of the following applications is a system requirement for the Sysmac Studio.

- .NET Framework 3.5

If not installed on your computer, download .NET Framework 3.5 SP1 from the Internet to install.

- .NET Framework 4.8

If not installed on your computer, it will be automatically installed.

Other system requirements are given below.

System requirement	Specification
Available hard disk space required at the start of DVD installation	12 GB min.
Available hard disk space required at the start of auto-updating	15 GB min.*1
Optical drive	DVD-ROM
Communications port	Ethernet or USB (USB 2.0)*2

*1. Available hard disk space required when you click the **Install** Button in the **OMRON Automation Software Upgrade Utility** Window to execute auto-updating.

*2. For hardware (e.g., PC and CPU unit) connection methods and cables, refer to the hardware manual for each unit.

● For Sysmac Studio (64 bit)

OS	CPU*1*2	RAM*2	Display*2
Windows 10 version 1607 or later (64-bit edition)	DOS/V (IBM AT compatible machines) personal computers equipped with Intel® Core™ i5-3xxx (3rd generation: Ivy Bridge) or equivalent/later processors are required.	4 GB min.	XGA 1,024 × 768, 16 million colors
Windows 11 (64-bit edition)		8 GB min. recom- mended	WXGA 1,280 × 800, 16 million colors recommended

*1. If you create a user program with a memory size over 20 MB, the personal computer equipped with Intel® Core™ i7 or an equal/faster processor and the RAM of 8 GB or more is recommended.

*2. Refer to the *Sysmac Studio 3D Simulation Function Operation Manual (Cat. No. W618)* for recommended system requirements to use the 3D Simulation Option function.

Apply the latest updates to the OS installed on your computer to ensure that it is always up-to-date. In addition, installation of the following applications is a system requirement for the Sysmac Studio.

- .NET Framework 3.5

If not installed on your computer, download .NET Framework 3.5 SP1 from the Internet to install.

- .NET Framework 4.8

If not installed on your computer, it will be automatically installed.

Other system requirements are given below.

System requirement	Specification
Available hard disk space required at the start of DVD installation	15 GB min.
Available hard disk space required at the start of auto-updating	18 GB min.* ¹
Optical drive	DVD-ROM
Communications port	Ethernet or USB (USB 2.0)* ²

*1. Available hard disk space required when you click the **Install** Button in the **OMRON Automation Software Upgrade Utility** Window to execute auto-updating.

*2. For hardware (e.g., PC and CPU unit) connection methods and cables, refer to the hardware manual for each unit.

1-4 Components

The components of the DVD and license are listed below. Make sure that all components are included.

- **DVD Media (SYSMAC-SE200D/SYSMAC-SE200D-64)**

Component	Description
Introduction	An introduction to the Sysmac Studio is provided.
Setup disk (DVD-ROM)	1

- **Licenses (SYSMAC-BA2□□L/ SYSMAC-AD2□□L/ SYSMAC-AD5□□L/ SYSMAC-SE2□□L/ SYSMAC-VE0□□L/ SYSMAC-ME0□□L/ SYSMAC-NE0□□L/ SYSMAC-DE0□□L/ SYSMAC-TA4□□L/ SYSMAC-FE0□□L/ SYSMAC-SA4□□L-64)**

Component	Description
License Agreement	The license agreement gives the usage conditions and warranty for the Sysmac Studio.
License Card	The following are given: Model number, version, license number, and number of licenses.
License Stickers* ¹	The following are given: Model number, version, license number, and number of licenses. Two stickers are provided.
User Registration Card* ¹	Two cards are provided, one for Japan and one for other countries.
Address Sheet* ¹	This is an address sheet that is used when the license is purchased outside of Japan.

*1. These items do not come with SYSMAC-BA2□□L, SYSMAC-AD2□□L, and SYSMAC-AD5□□L.



Precautions for Correct Use

The license number, which is required for installation, is given on the license certificate. Keep it in a safe place so that it is not lost.

2

Installation and Uninstallation

This section describes how to install and uninstall the Sysmac Studio.

2-1	Installing the Sysmac Studio	2-2
2-1-1	Confirmations before Installation	2-2
2-1-2	Requirements for Installation	2-2
2-1-3	Installing the Sysmac Studio	2-3
2-2	Uninstalling the Sysmac Studio	2-12
2-2-1	Uninstalling the Sysmac Studio	2-12
2-3	Auto-updating the Sysmac Studio.....	2-16
2-3-1	Confirmations before Implementing Auto-updating	2-16
2-3-2	Implementing an Auto-update	2-16

2-1 Installing the Sysmac Studio

2-1-1 Confirmations before Installation

Check the following items before you install the Sysmac Studio.

- To install the Sysmac Studio, log onto Windows as the administrator or as a user with administrator rights. There are files that a user without administrator rights cannot write. An access error will occur if you log on without administrator rights.
- Apply the latest updates to the OS to ensure that it is always up-to-date.
- Exit all applications that are running on the computer before you install the Sysmac Studio.
- You cannot install the Sysmac Studio from a network drive, such as a DVD drive or hardware drive that is shared on a network. Always install the Sysmac Studio from a DVD drive on the computer onto which you need to install the Sysmac Studio.
- Corrupted files cannot be restored on a compressed drive. Do not install the Sysmac Studio on a compressed drive.
- Do not cancel the setup while it is in progress. Files that were copied may remain in the installation directory.
- Do not turn OFF the power to the computer or reset the computer while the installation is in progress. Computer data may be corrupted.
- You may need to restart Windows after you install the Sysmac Studio. Restart as required according to Installation Wizard messages.

2-1-2 Requirements for Installation

Supported OS

You can install the Sysmac Studio on computers with any of the following operating systems.

	Sysmac Studio (32 bit)	Sysmac Studio (64 bit)
OS	Windows 7 SP1* ¹ (32-bit or 64-bit edition) Windows 8.1* ² (32-bit or 64-bit edition) Windows 10 version 1607 or later (32-bit or 64-bit edition) Windows 11 (64-bit edition)	Windows 10 version 1607 or later (64-bit edition) Windows 11 (64-bit edition)

*1. Windows 7 Update (KB4474419 and KB4490628) must be applied to the OS.

*2. Windows 8.1 Update (KB2919355) must be applied to the OS.

CX-One Installation

If the CX-One is installed on the computer, the operation when you install the Sysmac Studio depends on the version of the CX-One.

● Versions Earlier Than CX-One Version 4

Installation is cancelled and the Sysmac Studio cannot be installed. Uninstall the CX-One before you install the Sysmac Studio.

● CX-One Version 4 or Higher

You can install the Sysmac Studio*¹.

The Support Software*² and CX-Server are installed in the installation folder of the CX-One. If the same Support Software is already installed, it is overwritten.

*1. If the Sysmac Studio is installed on a computer with the CX-One and then the CX-One is uninstalled, the Support Software may no longer operate correctly.

*2. Here, "Support Software" indicates the CX-Integrator, CX-Designer, CX-Protocol, Network Configurator, and CX-ConfiguratorFDT.

Installed Application Software

The Sysmac Studio installs the following application software.

Name	Version
• Sysmac Studio	Ver. 1.□

Support Software: CX Common Tools

Name	Version
• CX-Integrator	Ver. 2.□
• CX-Designer	Ver. 3.□
• CX-Protocol	Ver. 2.□
• Network Configurator	Ver. 3.□
• CX-ConfiguratorFDT	Ver. 3.□

Support Software: Other Tools

Name	Version
• Adept Robot IP Address Setting Tool* ¹	Ver. 1.□

*1. The tool is always installed.

Communications Middleware

Name	Version
• CX-Server	Ver. 5.□
• Communications Middleware	Ver. 1.□

Other Application Software

Name	Version
• .NET Framework	Ver. 4.8
• DirectX	Ver. 11.0 or higher
• WinPcap	Ver. 4.□

2-1-3 Installing the Sysmac Studio

This section provides the procedure to install the Sysmac Studio.*¹

*1. If the CX-One is installed on the computer, you may not be able to install the Sysmac Studio depending on the version of the CX-One. Refer to *2-1-2 Requirements for Installation* on page 2-2 for details.

Preparations for Installation

- 1 Set the Sysmac Studio installation disk*¹ into the DVD-ROM drive.
The setup program is started automatically and the **Select Setup Language** Dialog Box is displayed.
*1. You can also download the installer image file for installation of the Sysmac Studio (64 bit) by signing up as a user on the License Portal site.
Visit our website at <https://license-user.automation.omron.com/> for details.
- 2 Select the language to use, and then click the **OK** Button.

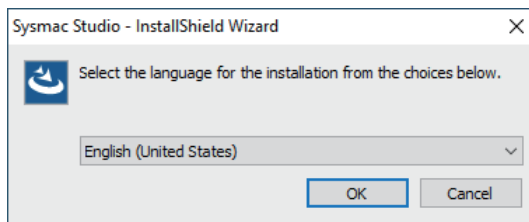

The Sysmac Studio Setup Wizard is started.

- If the OS is not up-to-date, you may be asked to apply the latest updates to the OS. Apply the latest updates to the OS and install the Sysmac Studio again.
- If .NET Framework 4.8 is not installed on the computer, the *.NET Framework 4.8* installation dialog box is displayed. To install, follow the instructions given in the dialog box. When .NET Framework has been installed, a confirmation dialog box to restart the computer is displayed. Always select **Yes, I want to restart my computer now** and click the **Finish** Button to restart.
After the computer is restarted, double-click the Setup.exe under the DVD-ROM drive to start the setup again.

- 3 Click the **Next** Button.

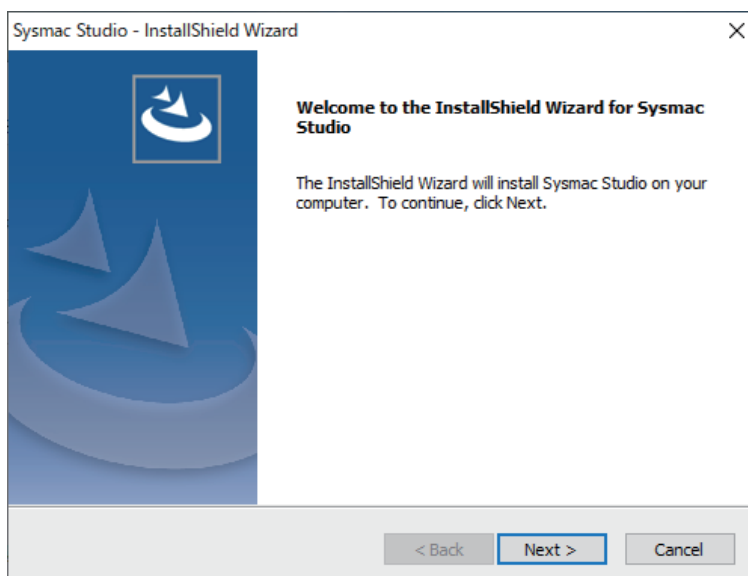

The **License Agreement** Dialog Box is displayed.

- 4** Read the License Agreement carefully. If you agree to all of the conditions, select the **I accept the terms of the license agreement** Option, and then click the **Next** Button.

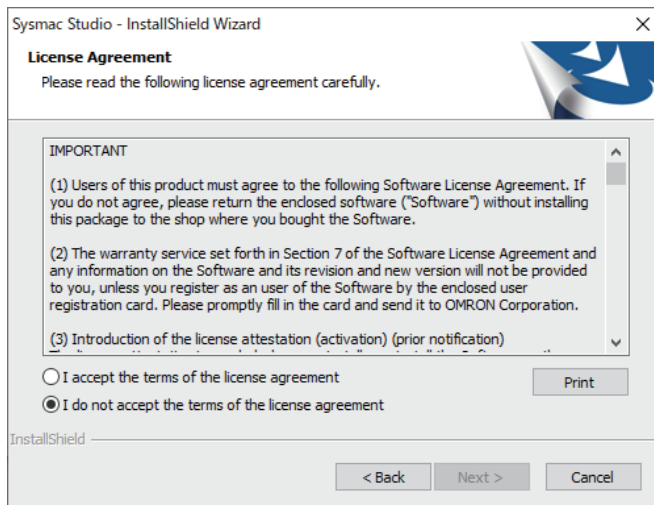

The **User Information** Dialog Box is displayed.

- 5** The names that are registered on the computer are automatically entered for the user name and company name. Enter the license number*¹ and then click the **Next** Button.

*1. You must purchase a license separately. For a 30-day period after installation, you can use a trial version that offers full functionality for free. During the trial period, there is no need to register for a license.

- For installer of 32-bit application
Refer to 1-3-1 *Product Model Numbers* on page 1-4 in 1-3 *Specifications* on page 1-4 for information on licenses.
- For installer of 64-bit application
There is no license entry field. Guidance for license registration and authentication will be displayed at the startup of the Sysmac Studio. Follow the guidance to perform registration and authentication.

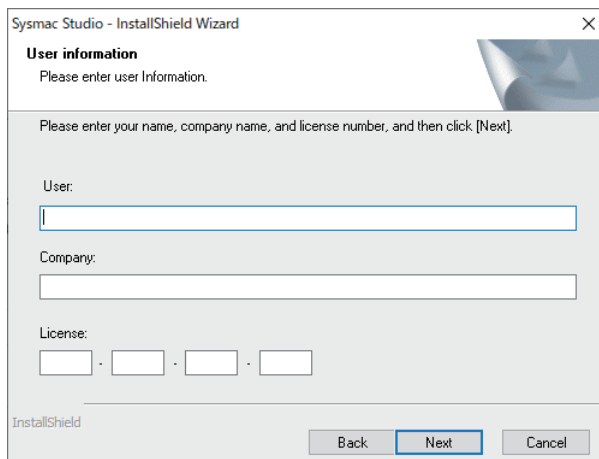

The **Regional Information** Dialog Box is displayed.

Note If the CX-One is installed, the **Regional Information** Dialog Box is not displayed and the location that was selected for the CX-One is used. Go to step 7.

- 6** Select the region where you purchased the Sysmac Studio, and then click the **Next** Button.

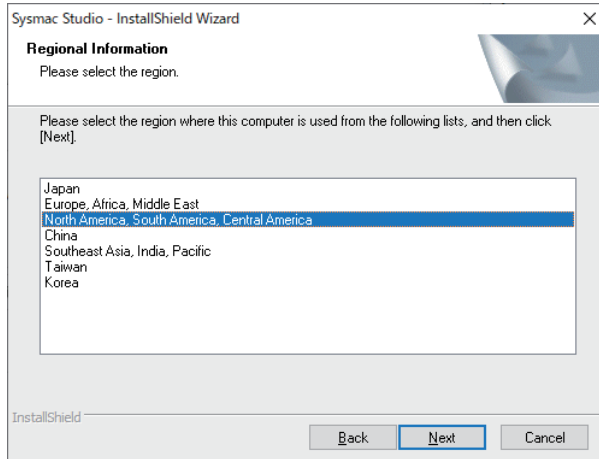

The **Choose Destination Location** Dialog Box is displayed.

- 7** Check the installation folder, and then click the **Next** Button.
The default installation folder is `C:\Program Files\OMRON\`.

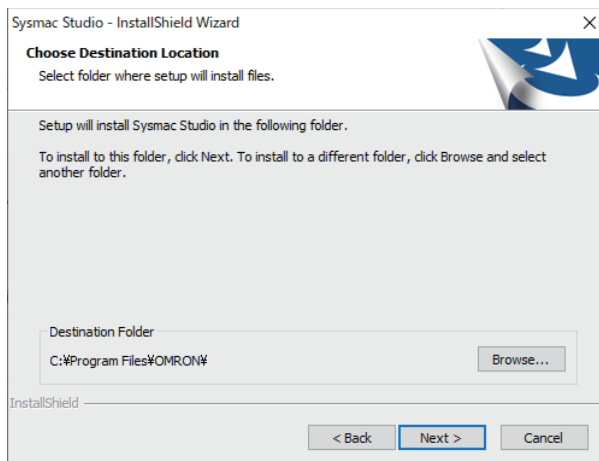

The **Setup Type** Dialog Box is displayed.

- 8** Select the *Complete* or *Custom* Option, and then click the **Next** Button.

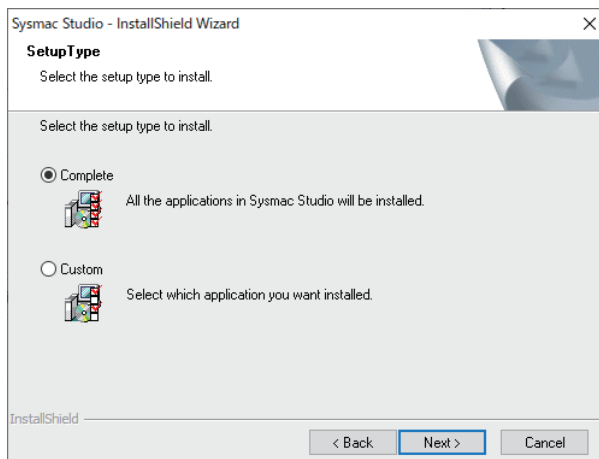

If you select the *Complete* Option, go to step 10.
If you select the *Custom* Option, go to step 9.

Note If CX-One version 4 is installed, the dialog box is not displayed. Go to step 10.

- 9** Select the **CX Common Tools** Check Box, and then click the **Next** Button.
The Sysmac Studio and communications middleware are installed by default. The selections of these cannot be cleared.

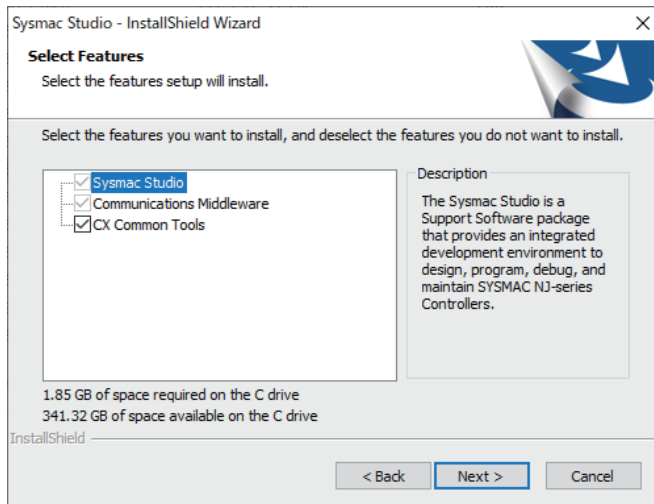

The **Ready to Install the Program** Dialog Box is displayed.

- 10** Click the **Install** Button.
To change the installation settings, click the **Back** Button.

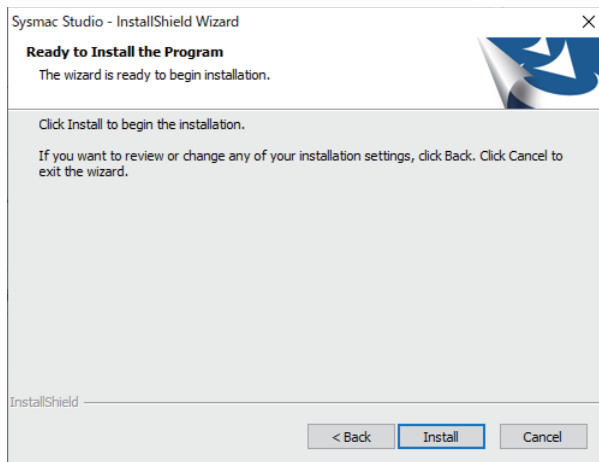

Installation of the Sysmac Studio starts.

Installing the USB Device Driver for the Controller

During installation wizard execution, a **Windows Security** Dialog Box is displayed.

- 1** Click the **Install** Button.

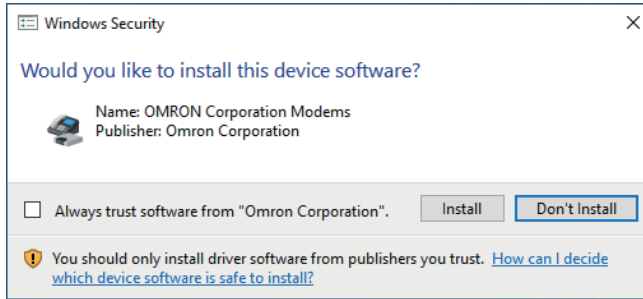

The *OMRON Corporation Modems* are installed and then the next **Windows Security** Dialog Box is displayed.

2 Click the **Install** Button.

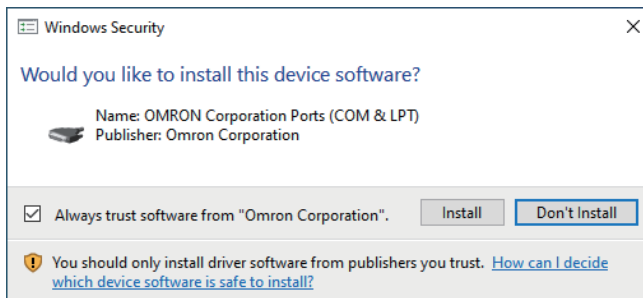

The *OMRON Corporation Ports (COM & LPT)* are installed.

3 Click the **Install** Button.

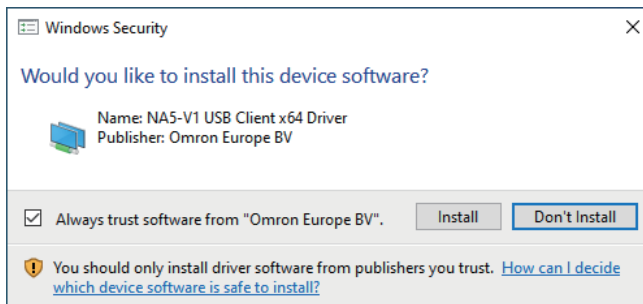

NA5-V1 USB Client xXX Driver is installed.

Installing WinPcap

During the installation, a dialog box will prompt you to install the WinPcap component of the communications middleware.

1 Click the **OK** Button.

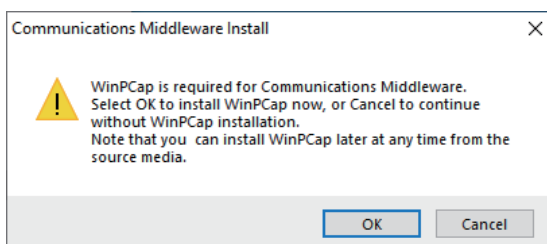

The WinPcap Setup Wizard is displayed.

- 2 Click the **Next** Button.

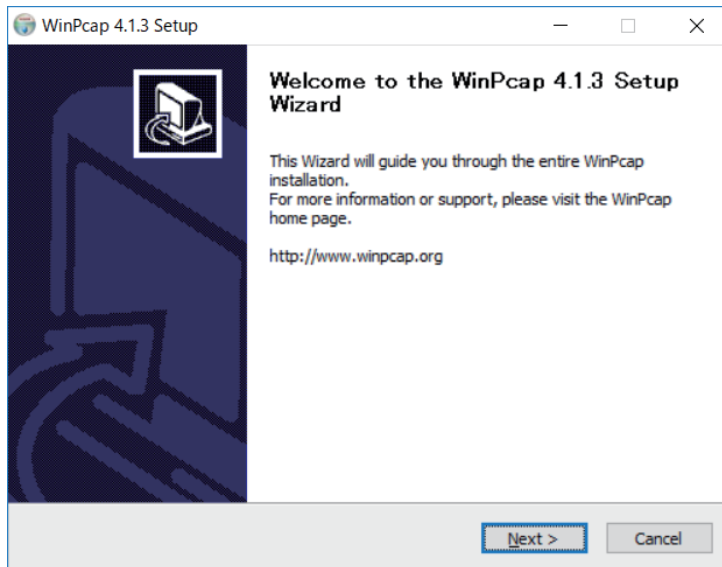

The WinPcap Installation Wizard is displayed.

- 3 Click the **Next** Button.
The License Agreement Dialog Box is displayed.
- 4 Read the License Agreement carefully. If you agree to all of the conditions, click the **I Agree** Button.
The Installation options Dialog Box is displayed.
- 5 Select the **Automatically start the WinPcap driver at boot time** Option, and then click the **Install** Button.
Installation of WinPcap starts.
- 6 Click the **Finish** Button.

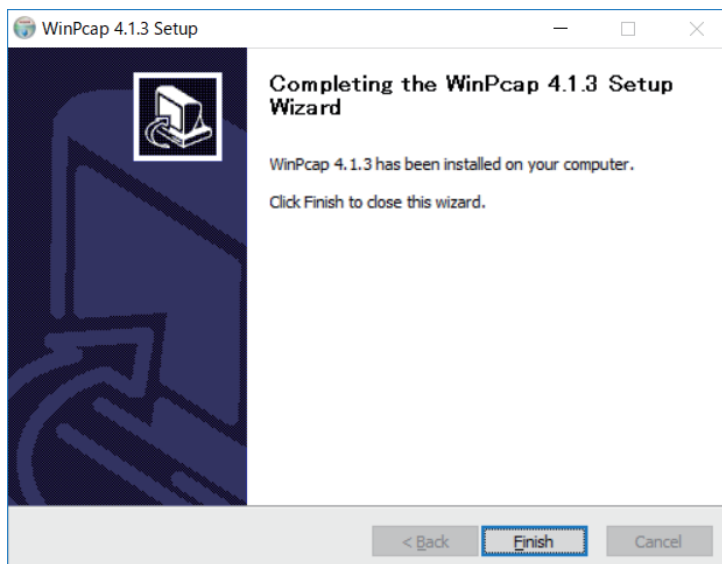

This completes the installation of WinPcap.

Ethernet Card Selection

During installation wizard execution, the **Direct Ethernet Connection: Network Card Selection** Dialog Box is displayed.

- 1 Select the network card for connecting the Controller with an Ethernet cable from the computer that runs the Sysmac Studio, and then click the **OK** Button.

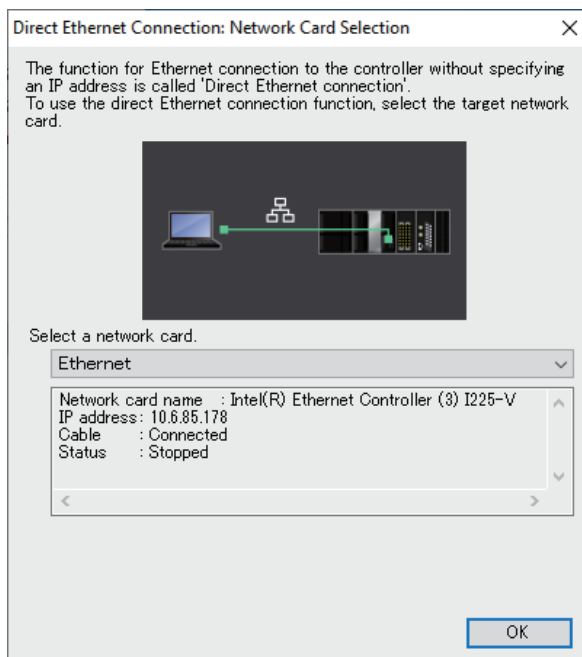

The network card for a direct Ethernet connection is selected and installation continues.

Installing the USB Driver for OMRON SYSMAC PLCs and NS-series PTs

During installation wizard execution, a **Windows Security** Dialog Box is displayed.

- 1 Click the **Install** Button.

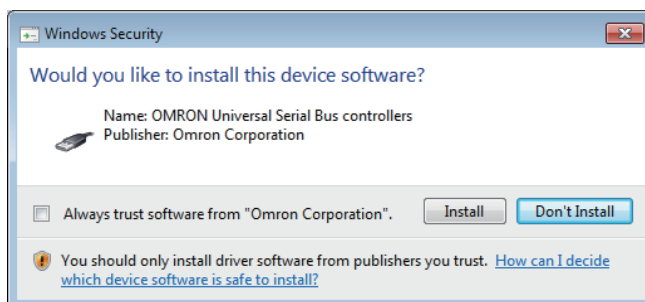

The *OMRON Universal Serial Bus controllers* are installed and then the **InstallShield Wizard Complete** Dialog Box is displayed.

If you are using Windows 8.1 or later and selected the **Complete** Option in step 8 in *Preparations for Installation* on page 2-4 or the *CX Common Tools* Check Box in step 9, the following message appears before the **InstallShield Wizard Complete** Dialog Box is displayed:
Microsoft .NET Framework 3.5 SP1 is required to use CX-ConfiguratorFDT. After installing Sysmac Studio, install the .NET Framework 3.5 SP1 from the Internet.

- 2 Select the **Yes, I want to restart my computer now** Option, and then click the **Finish** Button.

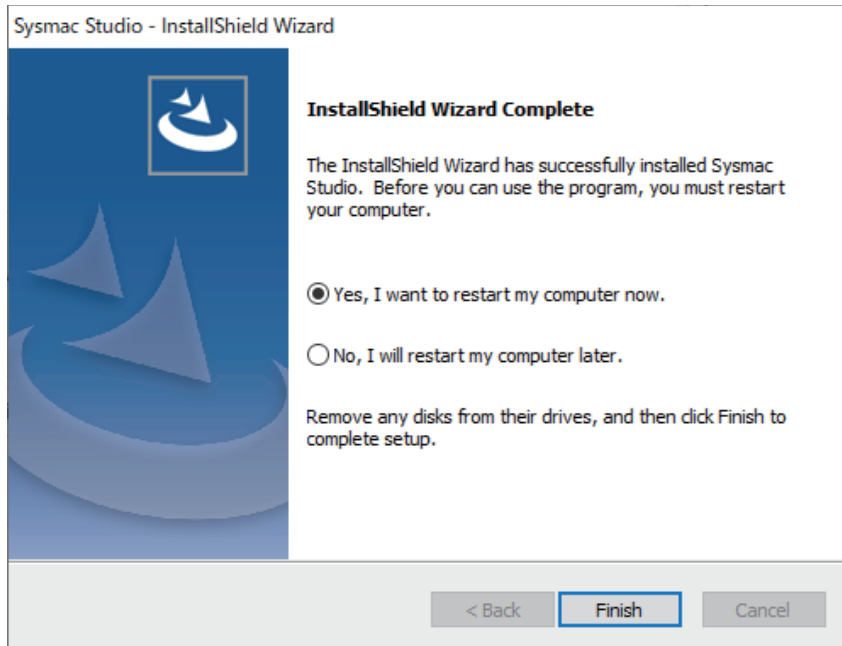

The computer is restarted.

This completes the installation of the Sysmac Studio.

2-2 Uninstalling the Sysmac Studio

2-2-1 Uninstalling the Sysmac Studio

Use the following steps to uninstall the Sysmac Studio.

- (1) Uninstall the Sysmac Studio.
- (2) Uninstall the Communications Middleware.
- (3) Uninstall the CX-Server Driver Manager*¹ and the CX-Server.*¹

*1. These are displayed if the Support Software is installed or if the Sysmac Studio is installed on a computer with the CX-One. To uninstall the CX-One, refer to the *CX-One Setup Manual* for the procedure.



Precautions for Correct Use

To uninstall the Sysmac Studio, log onto Windows as the administrator or as a user with administrator rights. Without administrator rights, you may not be able to access some folders, which results in unsuccessful uninstallation.

Uninstalling the Sysmac Studio

- 1 Open the **Control Panel** from the **Windows Start Menu** and then select **Programs and Features**.
The **Uninstall or change a program** Dialog Box is displayed.
- 2 Select *Sysmac Studio*, and then click the **Uninstall** Button.

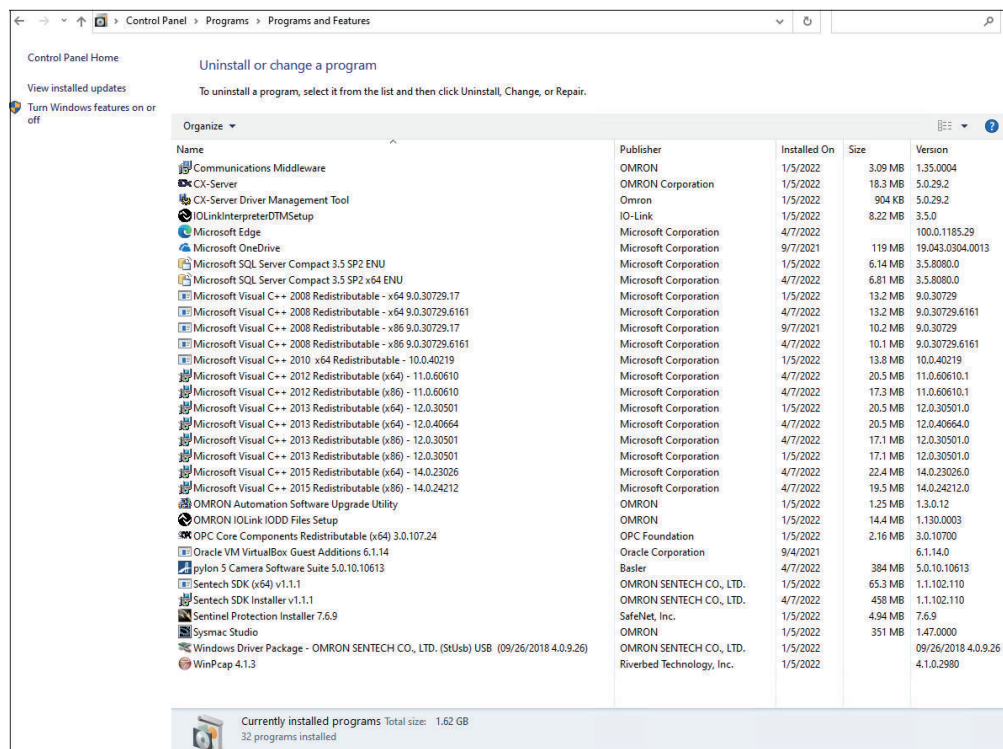

A dialog box is displayed to confirm deletion of the Sysmac Studio.

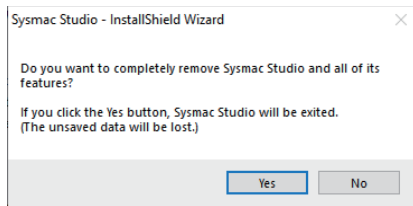
3 Click the **Yes** Button.

The Sysmac Studio is uninstalled and then a dialog box is displayed to confirm uninstallation of CX Common Tools.

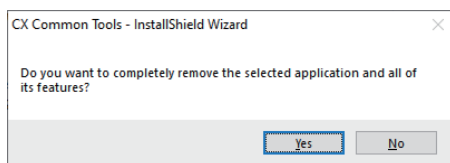
4 Click the **Yes** Button to continue removal of the CX Common Tools.
The CX Common Tools are removed.

Note Always click the **Yes** Button and remove the CX Common Tools completely. A dialog box is displayed after uninstallation of the Sysmac Studio is completed.

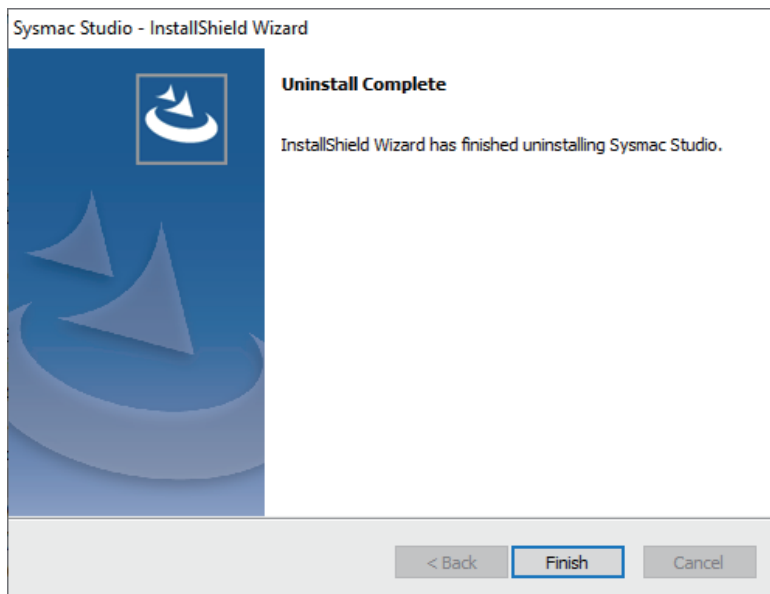
5 Click the **Finish** Button.

This completes the uninstallation of the Sysmac Studio.

Uninstalling the Communications Middleware

1 Open the **Control Panel** from the **Windows Start** Menu and then select **Programs and Features**.

The **Uninstall or change a program** Dialog Box is displayed.

- 2 Select *Communications Middleware*, and then click the **Uninstall** Button.
The following dialog box is displayed to confirm the uninstallation of Communication Middleware.
- 3 Click the **Yes** Button.

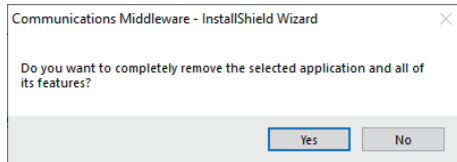

Uninstallation of the Communications Middleware is started.

- 4 Delete the Communications Middleware according to the messages in the dialog box.
The **Maintenance Completed** Dialog Box is displayed when uninstallation is completed.

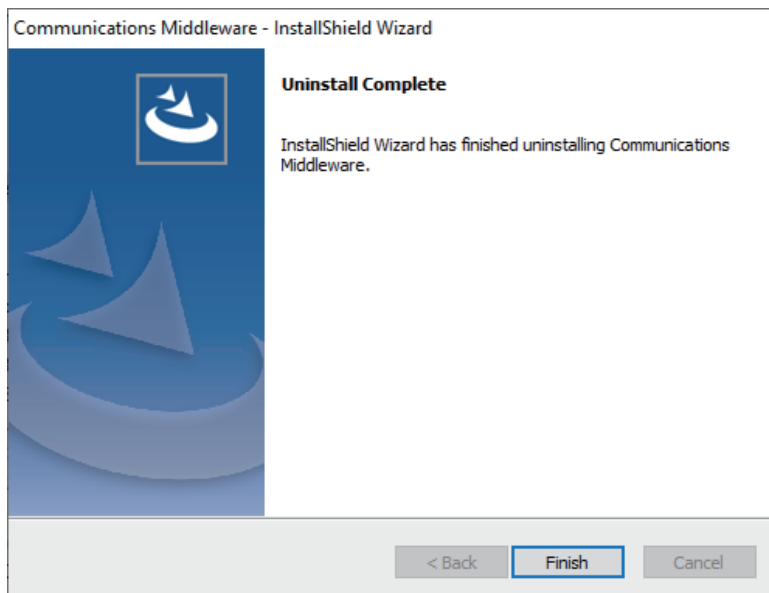

Uninstalling the CX-Server Driver Manager and the CX-Server

- 1 Open the **Control Panel** from the **Windows Start** Menu and then select **Programs and Features**.
The **Uninstall or change a program** Dialog Box is displayed.
- 2 Select *CX-Server Driver Manager Tool*, and then click the **Uninstall/Change** Button.
The following dialog box is displayed.
- 3 Click the **Yes** Button.

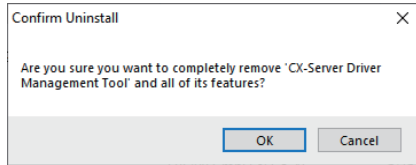

A dialog box is displayed to select the driver to remove.

- 4** Click the **Yes** Button to remove all device drivers.

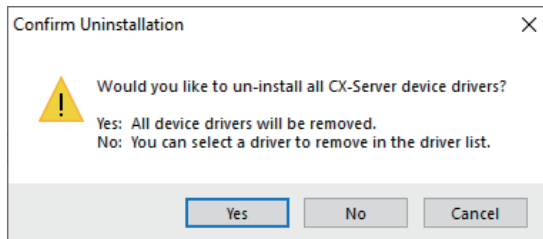

- 5** Delete the CX-Server Driver Manager according to the messages in the dialog box. The **Uninstall Complete** Dialog Box is displayed when the uninstallation of the CX-Server Driver Management Tool is completed.

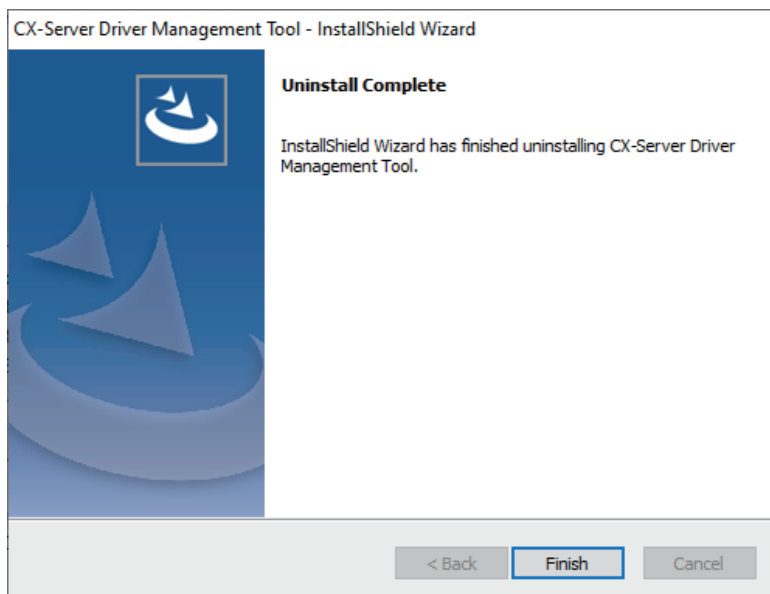

- 6** Continue by selecting the *CX-Server* and repeat the above procedure for uninstallation of CX-Server.

2-3 Auto-updating the Sysmac Studio

Auto-updating allows you to use an Internet connection to update the Sysmac Studio and its Support Software to the most current versions. If you use auto-updating, searches are made automatically for the newest versions of the currently installed Support Software from the Sysmac Studio package. When updates are found, they are installed to keep the Support Software that is installed from the Sysmac Studio package on your computer up to date.

2-3-1 Confirmations before Implementing Auto-updating

Check the following points before you start to update the software.

- Log onto Windows as the administrator or as a user with administrator rights.
- Exit all applications.
- Connect to the Internet.

2-3-2 Implementing an Auto-update

- 1 Select **All Programs - OMRON - Sysmac Studio - OMRON Automation Software AutoUpdate** from the **Windows Start Menu**.

The OMRON Automation Software Upgrade Utility starts and a list of the applications that are installed is displayed.

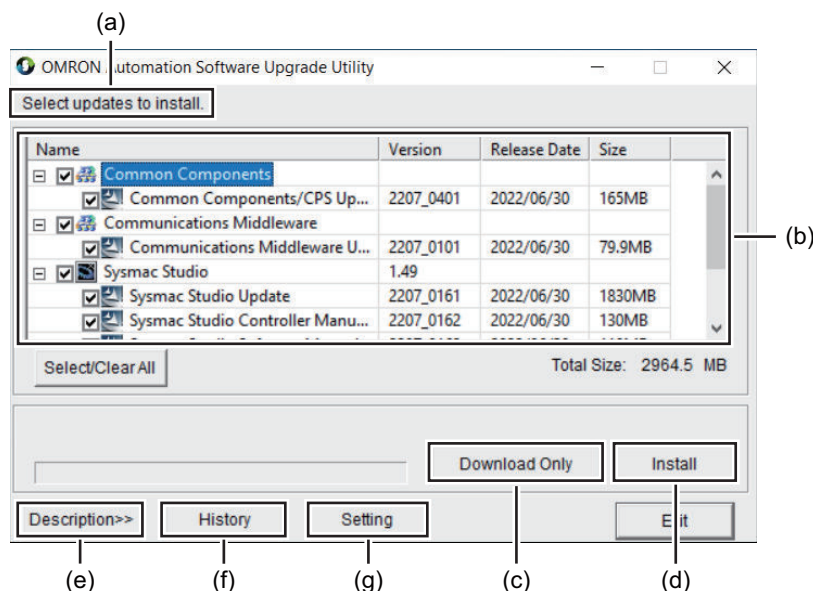

No.	Item	Description
(a)	Message area	Tells whether updates are available.
(b)	Update display area	Displays available updates and messages from OMRON.
(c)	Download Only Button	Downloads the selected updates and saves them to your computer. Click this button to install the updates later.
(d)	Install Button	Downloads the selected updates and installs them on your computer.
(e)	Description Button	Displays an update description area at the bottom of the dialog box.

No.	Item	Description
(f)	History Button	Displays a list of the applications that are installed and the updates that have been installed for each.
(g)	Setting Button	Displays a dialog box of the settings to periodically check for updates.

Click the + icon to see the updates that you can apply to an application.

The first time you implement an update, the User Authentication Dialog Box is displayed before the OMRON Automation Software Upgrade Utility starts. *1

Enter the items in the following table, and click the **OK** Button.

This dialog box is displayed only the first time that you install updates.

Item	Description
E-mail Address	Enter your email address.
License Number (16 digits)	Input the license number of the Sysmac Studio that you purchased.
Region	Select the region where you purchased the software. <ul style="list-style-type: none"> • Japan • Europe, Africa, or Middle East • North or South America • China • Southeast Asia, India, or Pacific region • Taiwan • Korea

*1. The User Authentication Dialog Box will not be displayed when the network license is registered and authenticated.

- 2** Select the updates to install and click the **Install** Button.
The selected updates are downloaded and installation starts automatically.
A dialog box that asks you to restart your computer is displayed after installation is completed.
- 3** Click the **Yes** Button to restart your computer and complete the updates. To restart later, click the **No** Button.



Additional Information

If there are updates to install for the OMRON Automation Software Upgrade Utility, the following dialog box is displayed when you start the utility. Click the **OK** Button to update the program.

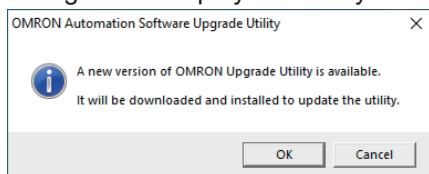

3

System Design

This section describes the basic concepts for designing an NJ/NX/NY-series System with the Sysmac Studio and the basic operating procedures.

3-1	Basic Flow of System Design 1	3-3
3-2	Basic Flow of System Design 2	3-6
3-3	Creating a Project	3-9
3-3-1	Starting and Exiting the Sysmac Studio	3-9
3-3-2	Creating a Project File	3-11
3-3-3	Closing a Project File and Returning to the Start Page	3-16
3-3-4	Saving the Project File	3-17
3-3-5	Saving a Project File Under a Different Name	3-17
3-3-6	Opening a Project File	3-18
3-3-7	Exporting a Project File	3-19
3-3-8	Importing a Project File	3-21
3-3-9	Password Protection for Project Files	3-22
3-3-10	Project Update History Management	3-25
3-3-11	Creating a Project from an Online Connection	3-28
3-3-12	Displaying and Registering Licenses	3-28
3-3-13	Project Version Control	3-29
3-3-14	Project File Management Mode	3-30
3-4	Parts of the Window	3-32
3-4-1	Application Window	3-32
3-4-2	Multiview Explorer (1)	3-33
3-4-3	Edit Pane (3)	3-36
3-4-4	Toolbox (4)	3-41
3-4-5	Changing the Display Location of Window Parts	3-44
3-4-6	Saving and Restoring the Window Layout	3-48
3-5	Menu Command Structure	3-52
3-6	Basic Editing Operations	3-59
3-7	Sysmac Studio Settings and Operations	3-62
3-7-1	Setting Parameters	3-62
3-7-2	Programming	3-68
3-7-3	Library Functions	3-71
3-7-4	Project Management	3-72
3-7-5	Debugging	3-73
3-7-6	Simulation	3-75
3-7-7	Monitoring Information	3-76
3-7-8	Communications	3-77

3-7-9	Maintenance.....	3-77
3-7-10	Security Measures.....	3-78
3-7-11	Customizing Function.....	3-79
3-7-12	Window Operation.....	3-80
3-7-13	Online Help.....	3-80
3-7-14	OPC UA Functions.....	3-81
3-7-15	Function Specifications of DB Connection Function.....	3-82
3-7-16	CNC Functions.....	3-82
3-7-17	EtherNet/IP Connection Settings.....	3-83
3-7-18	EtherNet/IP Slave Terminal Settings.....	3-83
3-7-19	PROFINET Slave Terminal Settings.....	3-84
3-7-20	Function Specifications of Safety Control Units.....	3-85
3-7-21	Function Specifications of NA-series Programmable Terminals.....	3-90
3-7-22	Vision Sensor Functions.....	3-96
3-7-23	Displacement Sensor Functions.....	3-103
3-7-24	Team Development Option.....	3-104
3-7-25	3D Simulation Function.....	3-105
3-7-26	Robot Function.....	3-106
3-7-27	Application Manager Function.....	3-109
3-7-28	Automation Playback Function.....	3-113

3-1 Basic Flow of System Design 1

This section gives the basic flow and settings that are required to use the Sysmac Studio to design a user program that takes advantage of the characteristics of IEC 61131-3 programming.

This basic flow is suitable for user program design in a development scenario in which hardware and software specifications are determined in phases. The procedures are described below.

● Creating a Project

A project file is created.

1. Starting the Sysmac Studio: Start the Sysmac Studio.

3-3-1 Starting and Exiting the Sysmac Studio on page 3-9

2. Creating a Project: Create a project.

3-3-2 Creating a Project File on page 3-11



● Designing the User Program

Variables and POUs are registered.

1. Registering Global Variables: Register user-defined variables that are used in more than one program in the **Global Variables**.

4-1 Variable Registration on page 4-3

2. Registering POUs: Register the programs, functions, and function blocks as **POUs**.

4-2 Registering POUs on page 4-57

3. Registering Local Variables: Register the user-defined variables that are used in only one POU in the **Local Variables** for that POU.

4-1 Variable Registration on page 4-3

4. Registering Axis Variables: Register the Axis Variables that are used in the user program in the **Axis Settings**.

4-1 Variable Registration on page 4-3

5. Registering Axes Group Variables: Register the Axes Group Variables that are used in programs that control interpolates axes in the **Axes Group Settings**.

4-1 Variable Registration on page 4-3

6. Registering Cam Data Variables: Register the cam data variables that are used in the user program in the **Cam Data Settings**.

4-1 Variable Registration on page 4-3

7. Creating the POU Algorithms: Create the POU algorithms.

4-5 Programming Ladder Diagrams on page 4-85

4-8 Searching and Replacing on page 4-168



● Controller Configurations and Setup

The Controller Configurations and Setup are created.

- Controller Configurations:

1. Creating the EtherCAT Configuration: Register the EtherCAT slaves in the **EtherCAT Configuration**.
2. Creating the CPU/Expansion Rack Configuration: Register the Units in the **CPU/Expansion Racks Configuration**.
3. Registering Device Variables: Register device variables to user-defined variables in the **I/O Map** to use or to edit and use device variables in the user program. The device variables interface the user program with I/O information from the devices (slaves and Units).

5-2 EtherCAT Configuration and Setup on page 5-4
5-5 CPU/Expansion Rack Configuration and Setup on page 5-44
4-1 Variable Registration on page 4-3

- Controller Setup:

1. Editing Slave Parameters: Edit the Operation Settings of the slaves.
2. Editing Unit Parameters: Edit the Operation Settings of the Units.
3. Editing Controller Setup: Edit the Operation Settings of the Controller in the **Controller Setup**.
4. Editing Axes: Edit the Operation Settings of the axes that you registered in the **Axis Settings**.
5. Editing Axes Groups: Edit the Operation Settings of the interpolated axes that you registered in the **Axes Group Settings**.

5-4 Setting EtherCAT Drives on page 5-37
5-5 CPU/Expansion Rack Configuration and Setup on page 5-44
5-6 Controller Setup on page 5-65
5-7 Motion Control Setup on page 5-80
5-7 Motion Control Setup on page 5-80



● Designing Tasks

The tasks, which are used to execute programs, are created.

1. Registering Tasks: Register the tasks in **Tasks**.
2. Designing Tasks: Design the operation of the tasks.
3. Editing Tasks: Assign programs to the tasks.
4. Editing Tasks: Design the I/O that are controlled by the tasks and the variables that are shared between tasks.

5-9 Task Settings on page 5-125
5-9 Task Settings on page 5-125
5-9 Task Settings on page 5-125
5-9 Task Settings on page 5-125



● Offline Program Debugging

The Simulator is used to debug the program.

1. Debugging through Simulation: Start the Simulator and debug the user program.

7-3 Offline Debugging on page 7-86



● Preparations for Online Debugging

The settings that are required for online debugging are made.

1. Assigning Axis Variables and I/O Devices: Assign the axis variables and I/O devices in the **Axis Settings**.
2. Assigning Variables and Real I/O: Assign the user-defined variables and I/O devices in the **I/O Map**.

7-4-2 Assigning Axis Variables and I/O Devices on page 7-124

7-4-1 Assigning Variables and Real I/O on page 7-122



● Online Program Debugging

Debugging is performed on the physical system.

1. Transferring Data to the Controller: Transfer the user program, system configuration, and variable information to the Controller.
2. Testing Axis Operation: Use the MC Test Run to check wiring.
3. Checking I/O: Use the **I/O Map** to check the I/O status between internal I/O devices and external I/O devices, and the wiring to external I/O devices.
4. Checking Assignments: Use a **Watch Tab Page** to check the assignments between user-defined variables and I/O devices.

7-5-1 Transferring/Comparing Data to/from the Controller on page 7-127

7-5-2 Testing Axis Operation (MC Test Run) on page 7-149

7-5-3 Checking I/O Wiring on page 7-153

7-5-4 Checking I/O Assignments on page 7-154



● Testing Operation

Final debugging of the user program is performed using trial operation.

1. Debugging Programming with Data Traces: Execute data traces to check the operation of the user program.

7-2-11 Data Tracing on page 7-53

3-2 Basic Flow of System Design 2

This section gives the basic flow and settings that are required to use the Sysmac Studio to design a user program in a traditional top-down fashion.

This basic flow is suitable for user program design in a development scenario in which hardware and software specifications are determined in advance. The procedures are described below.

● Creating a Project

A project file is created.

1. Starting the Sysmac Studio: Start the Sysmac Studio.
2. Creating a Project: Create a project.

3-3-1 Starting and Exiting the Sysmac Studio
on page 3-9

3-3-2 Creating a Project File on page 3-11



● Controller Configurations and Setup

The Controller Configurations and Setup are created.

- Controller Configurations:
 1. Creating the EtherCAT Configuration: Register the EtherCAT slaves in the **EtherCAT Configuration**.
 2. Creating the CPU/Expansion Rack Configuration: Register the Units in the **CPU/Expansion Racks Configuration**.
- Controller Setup:
 1. Editing Slave Parameters: Edit the Operation Settings of the slaves.
 2. Editing Unit Parameters: Edit the Operation Settings of the Units.
 3. Editing Controller Setup: Edit the Operation Settings of the Controller in the **Controller Setup**.
 4. Registering Axis Variables: Register the Axis Variables that are used in the user program in the **Axis Settings**.
 5. Registering Axes Group Variables: Register the Axes Group Variables that are used in programs that control interpolates axes in the **Axes Group Settings**.
 6. Editing Axes: Edit the Operation Settings of the axes that you registered in the **Axis Settings**.
 7. Editing Axes Groups: Edit the Operation Settings of the interpolated axes that you registered in the **Axes Group Settings**.

5-2 EtherCAT Configuration and Setup on page 5-4
5-5 CPU/Expansion Rack Configuration and Setup on page 5-44

4-1 Variable Registration on page 4-3

5-9 Task Settings on page 5-125

5-5 CPU/Expansion Rack Configuration and Setup on page 5-44

4-1 Variable Registration on page 4-3

4-1 Variable Registration on page 4-3

5-7 Motion Control Setup on page 5-80

5-7 Motion Control Setup on page 5-80



● Designing the User Program

The variables are registered and the POUs are created.

1. Registering Global Variables: Register user-defined variables that are used in more than one program in the **Global Variables**.
2. Registering POUs: Register the programs, functions, and function blocks as **POUs**.
3. Registering Local Variables: Register the user-defined variables that are used in only one POU in the **Local Variables** for that POU.
4. Registering Device Variables: Register device variables to user-defined variables in the **I/O Map** to use or to edit and use device variables in the user program. The device variables interface the user program with I/O information from the devices (slaves and Units).
5. Registering Cam Data Variables: Register the cam data variables that are used in the user program in the **Cam Data Settings**.
6. Creating the POU Algorithms: Create the POU algorithms.

4-1 *Variable Registration* on page 4-3

4-2 *Registering POUs* on page 4-57

4-1 *Variable Registration* on page 4-3

4-1 *Variable Registration* on page 4-3

4-1 *Variable Registration* on page 4-3

4-5 *Programming Ladder Diagrams* on page 4-85

4-6 *Programming Structured Text* on page 4-152



● Designing Tasks

The tasks, which are used to execute programs, are created.

1. Registering Tasks: Register the tasks in **Tasks**.
2. Editing Tasks: Assign programs to the tasks.
3. Editing Tasks: Design the I/O that are controlled by the tasks and the variables that are shared between tasks.

5-9 *Task Settings* on page 5-125

5-9 *Task Settings* on page 5-125

5-9 *Task Settings* on page 5-125



● Offline Program Debugging

The Simulator is used to debug the program.

1. Debugging through Simulation: Start the Simulator and debug the user program.

7-3 *Offline Debugging* on page 7-86



● Preparations for Online Debugging

The settings that are required for online debugging are made.

1. Assigning Axis Variables and I/O Devices: Assign the axis variables and I/O devices in the **Axis Settings**.
2. Assigning Variables and Real I/O: Assign the user-defined variables and I/O devices in the **I/O Map**.

7-4-2 Assigning Axis Variables and I/O Devices on page 7-124

7-4-1 Assigning Variables and Real I/O on page 7-122



● Online Program Debugging

Debugging is performed on the physical system.

1. Transferring Data to the Controller: Transfer the user program, system configuration, and variable information to the Controller.
2. Testing Axis Operation: Use the MC Test Run to check wiring.
3. Checking I/O: Use the **I/O Map** to check the I/O status between internal I/O devices and external I/O devices, and the wiring to external I/O devices.
4. Checking Assignments: Use a **Watch Tab Page** to check the assignments between user-defined variables and I/O devices.

7-5-1 Transferring/Comparing Data to/from the Controller on page 7-127

7-5-2 Testing Axis Operation (MC Test Run) on page 7-149

7-5-3 Checking I/O Wiring on page 7-153

7-5-4 Checking I/O Assignments on page 7-154



● Testing Operation

Final debugging of the user program is performed using trial operation.

1. Debugging Programming with Data Traces: Execute data traces to check the operation of the user program.

7-2-11 Data Tracing on page 7-53

3-3 Creating a Project

This section describes how to start and exit the Sysmac Studio, create and save projects, and perform other basic operations.

3-3-1 Starting and Exiting the Sysmac Studio



Precautions for Correct Use

Observe the following precautions when you start the Sysmac Studio or any of the Support Software that is provided with it.

- If you start the Sysmac Studio as a user without administrator rights, you may not be able to use some functions due to a file access error. In this case, enable the *User Account Control (UAC)* of Windows and restart the Sysmac Studio.
- If you use the simulation features of an HMI, be sure to log onto Windows as the administrator or as a user with administrator rights and start the Sysmac Studio.
- Exit all applications that are not necessary to use the Sysmac Studio. For virus checker or other software that could affect the startup and operations of the Sysmac Studio, take measures such as to remove the Sysmac Studio from the scope of virus checking.
- If any hard disks or printers that are connected to the computer are shared with other computers on a network, isolate them so that they are no longer shared.
- With some notebook computers, the default settings assign the USB port to a modem or infrared communications. Refer to the user documentation for your computer and set the USB port as a normal serial port.
- With some notebook computers, the default settings do not supply power to the USB port or Ethernet port to save energy. There are energy-saving settings in Windows, and also sometimes in utilities or the BIOS of the computer. Refer to the user documentation for your computer and disable all energy-saving features.
- To register a license, you must log onto Windows as a user with administrator rights.

Starting the Sysmac Studio

Use one of the following methods to start the Sysmac Studio.

- Double-click the **Sysmac Studio** shortcut icon on your desktop.



- Select **All Programs - OMRON - Sysmac Studio - Sysmac Studio** from the Windows Start Menu.

The Sysmac Studio starts and the following window is displayed. This window is called the Start page.

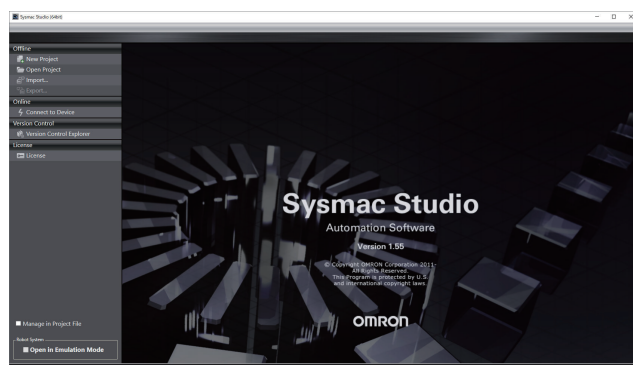

Before registering and authenticating your license, e.g., immediately after you install the Sysmac Studio newly, you can use it as a 30-day trial version.

For the 64-bit application, if you have not finished license registration and authentication, the license authentication guidance dialog will appear before the start page is displayed. Following instructions on the dialog, register and authenticate your license.

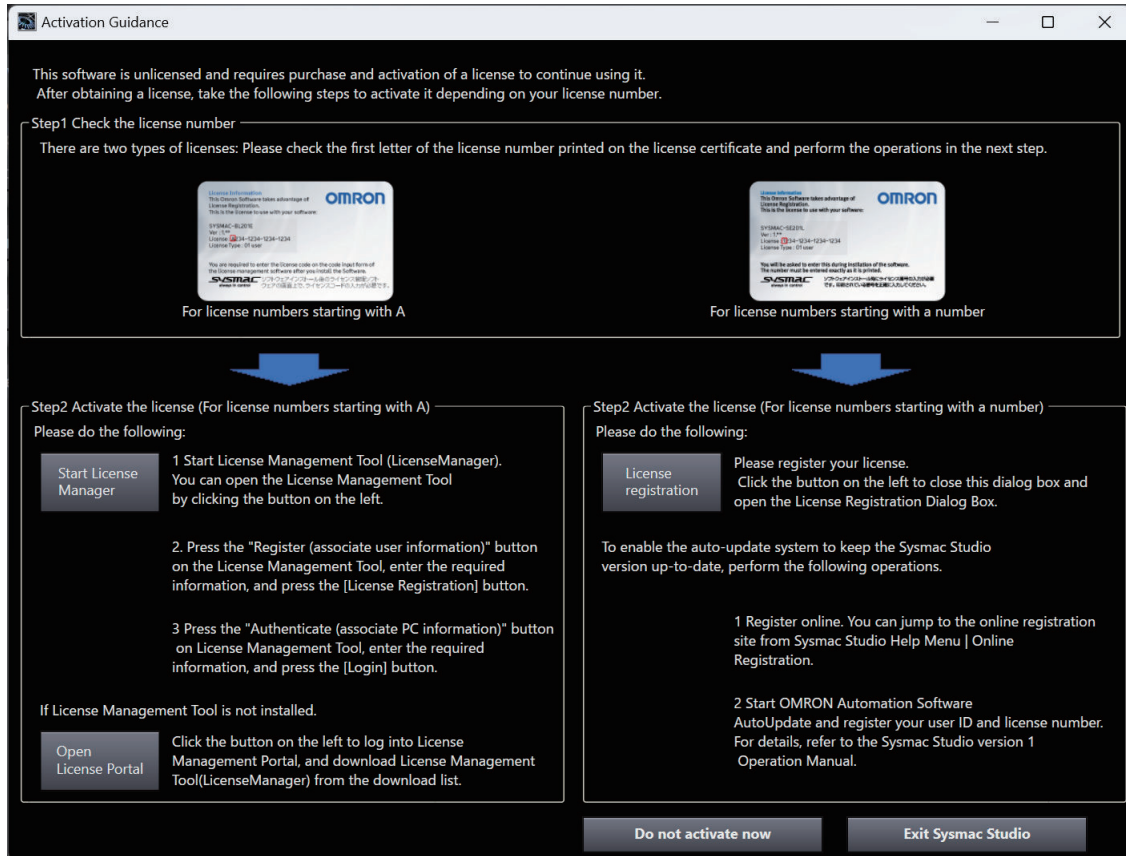

Exiting the Sysmac Studio

Use one of the following methods to exit the Sysmac Studio.

- Click the **Close** Button in the title bar.

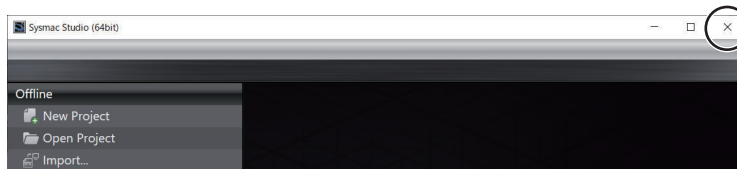

- Select **Exit** from the **File** Menu.

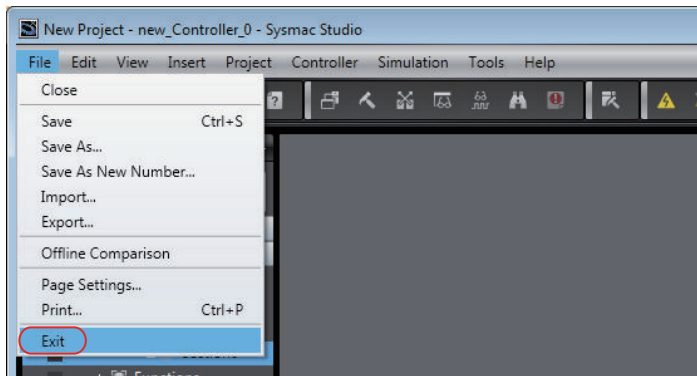

The Sysmac Studio will close.

Note This menu is not displayed if the Start page is displayed. Click the **Close** Button in the title bar.



Additional Information

If there is unsaved data when you exit the Sysmac Studio, a dialog box will appear that asks if you want to save the data.

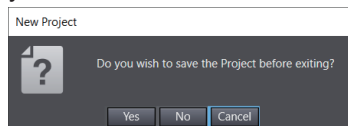

Save the data if required. The Sysmac Studio will close after this operation.

3-3-2 Creating a Project File

This section describes how to create a project file.

Creating a Project File from the Start Page

Use the following procedure to create a project file from the Start page.

- 1 Click **New Project** on the Start page.

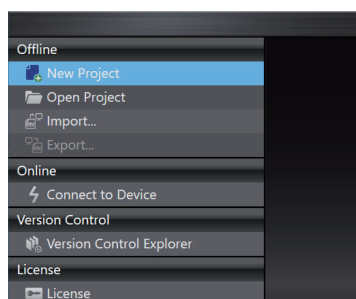

The **Project Properties** Screen is displayed.

The following table gives the functions of the buttons.

Button	Function
New Project	Creates a project file.
Open Project	Opens an existing project file.

- 2** Enter the **project name** (mandatory), **author** (optional), and **comment** (optional) in the **Project Properties** Screen, select the device category, the device to use, and the version, and then click the **Create** Button.

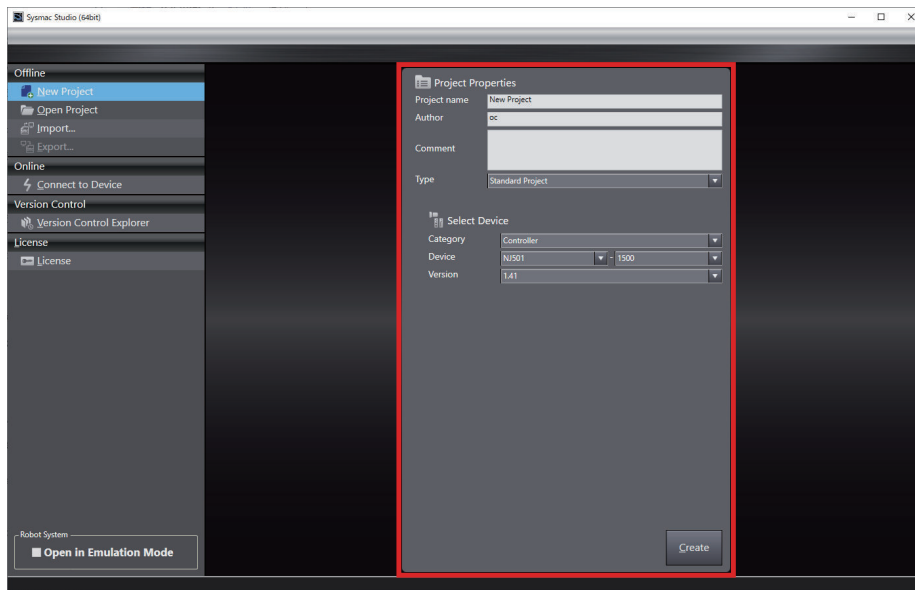

The property settings are listed below.

Property	Description
Project name	Enter the project name.
Author	Enter the author name. If this is the first time you are creating a project after installing the Sysmac Studio, the user name that you entered when you logged on-to Windows is displayed.*1
Comment	Enter a comment.
Type	Select the project type. <ul style="list-style-type: none"> Standard Project This type is used for a normal project. Library Project This type is used to create a library project. Refer to 9-3 <i>Creating and Using Libraries</i> on page 9-8 for information on libraries. IAG Project This type is used to create an IAG to use with an NA-series PT. Refer to the <i>NA-series Programmable Terminal Software User's Manual (Cat. No. V118)</i> for details.

*1. You can change the author name that is displayed when you create a project. Change it in the option settings. Refer to the 8-26 *Sysmac Studio Option Settings* on page 8-166 for details.

You can change the properties later. Refer to *Editing Project File Properties* on page 3-15, below.



Additional Information

In the Sysmac Studio (64 bit), at the bottom left of the start page, **Robot System – Open in Emulation Mode** is displayed. This feature is only available for projects that use Robot Integrated CPU Units. For more information, refer to the *Sysmac Studio Robot Integrated System Building Function with Robot Integrated CPU Unit Operation Manual (Cat. No. W595)*.

If you select a Vision Sensor, specify the model of the Vision Sensor in the next dialog box and then click the **OK** Button.

A project file is created and the following window is displayed.

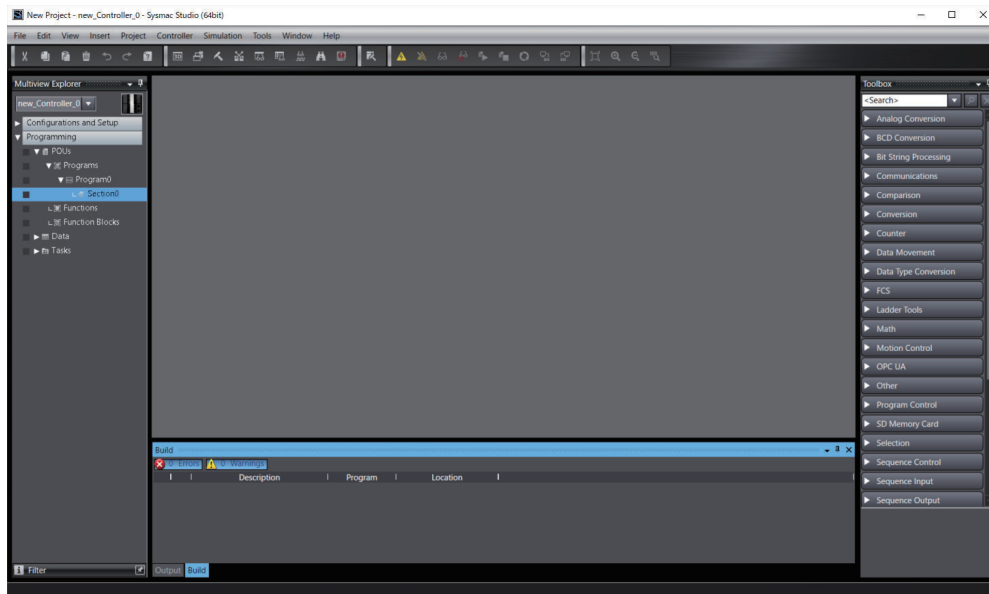

A project file is created with the specified device already inserted.

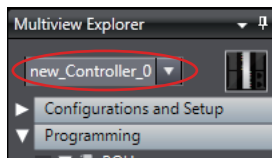

Adding Devices

Right-click the Controller Icon and select **Add Device** from the menu.

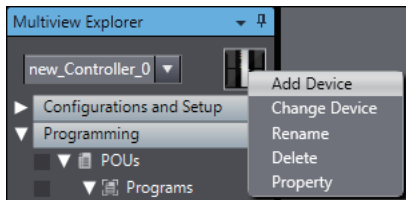

Or, select the device directly from the Insert Menu. Example: **Controller-NJ501**.

The Add Device Dialog Box is displayed.

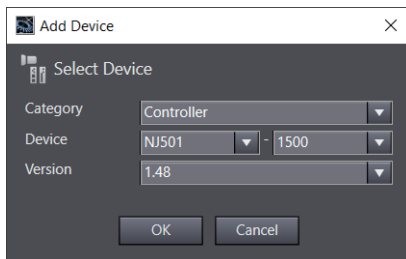

Select the device and then click the **OK** Button. The device is added to the project.

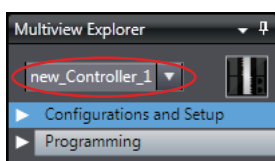

To add Vision Sensors, Displacement Sensors (Measurement Sensors), HMIs, or Slave Terminals, select them from the Insert Menu.

To change the target device, select a device from the list.

Changing Devices

Right-click the device icon and select **Change Device** from the menu. Or, select the **Change Device** from the Controller Menu.

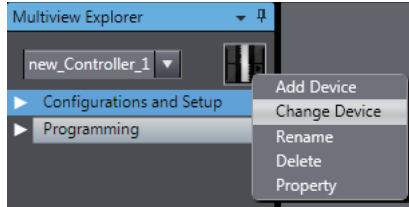

The Change Device Dialog Box is displayed.

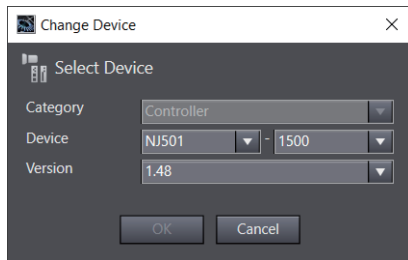

Select the device and then click the **OK** Button. The device is changed.



Precautions for Correct Use

- If you change the device, the settings for functions that are not supported by the new model will be lost.
 - You cannot *change the device* for a Vision Sensor.
 - You cannot change to a different category.
-

Controller Versions

If you select a Controller for the device, set the *version*.

You can set the *version* to the unit version of the Controller that you are using or to any earlier unit version. You can program and make settings within the ranges that are supported for the unit version that you set for the Controller. If you attempt to use functions that are not supported by the unit version that you set, you will not be able to use them or errors will occur.

For example, if you set the *version* to 1.01 for an NJ-series Controller, you can use the Controller within the ranges that are supported by unit version 1.01 of the Controller. In this case, you can transfer the user program that you created to a Controller with unit version 1.02, but you cannot transfer it to a Controller with a unit version of 1.00.

You can change the *version* after you add a Controller.

Refer to the *NJ/NX-series CPU Unit Software User's Manual (Cat. No. W501)* and *NY-series Industrial Panel PC / Industrial Box PC Software User's Manual (Cat. No. W558)* for information on Controller unit versions and supported functions.



Precautions for Correct Use

If you change the unit version, the settings for functions that are not supported by the new unit version will be lost.



Precautions for Safe Use

If the configuration of the EtherCAT network includes an EtherCAT slave that cannot be used by the Controllers after changing model, the configuration and settings of the EtherCAT network will be all cleared. In that case, create and set an EtherCAT network configuration again.

Editing Project File Properties

Use the following procedure to edit the properties of a project file.

- 1 Click **Open Project** on the Start page and select the project file to edit.

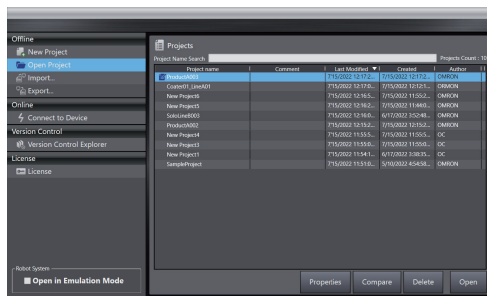

- 2 Click the **Properties** Button. Or click the **Edit Properties** icon () that appears to the left of the selected project file.

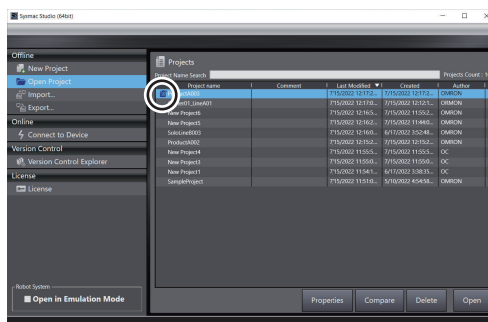

The **Project Properties** Dialog Box is displayed.

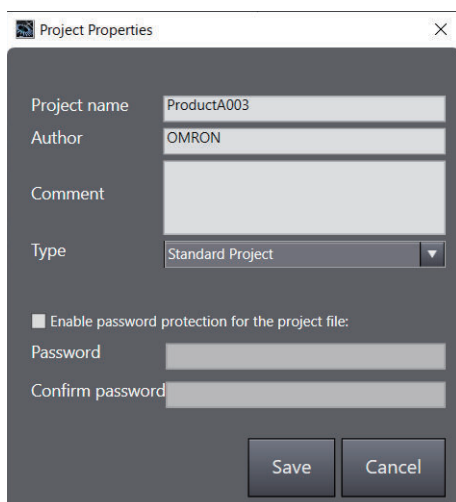

Property	Value
Type	Select a standard project or a library project. Refer to 9-3 <i>Creating and Using Libraries</i> on page 9-8 for information on library projects.
Enable password protection for the project file	Select this option to enable setting password protection for the project file. Refer to 3-3-9 <i>Password Protection for Project Files</i> on page 3-22 for details.

- 3 Edit the properties, and then click the Save Button.
The properties are saved.

3-3-3 Closing a Project File and Returning to the Start Page

When you close a project file, you will return to the Start page.
Use the following procedure.

- 1 Select **Close** from the **File** Menu.

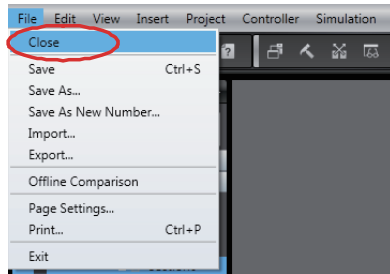

A dialog box is displayed to ask if you need to save the **project**.

- 2 Click the **Yes** Button in the following dialog box.

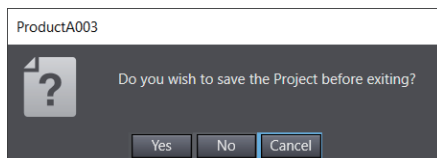

The project name is registered in the project properties and the Start page is displayed.

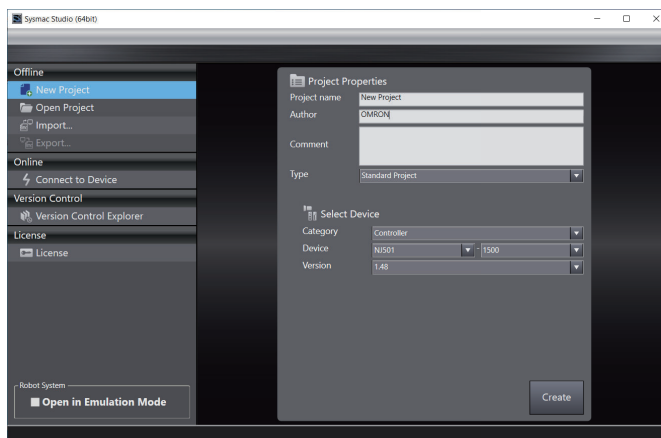

If you click the **No** Button, the Start page is displayed without saving the project.
You can check the name of the registered project if you click **Open Project** on the Start page.

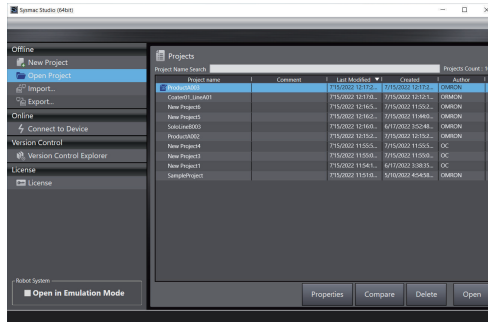

3-3-4 Saving the Project File

This section describes how to save the project file.

- 1 Select **Save** from the **File** Menu. (Or press the Ctrl + S Keys.)

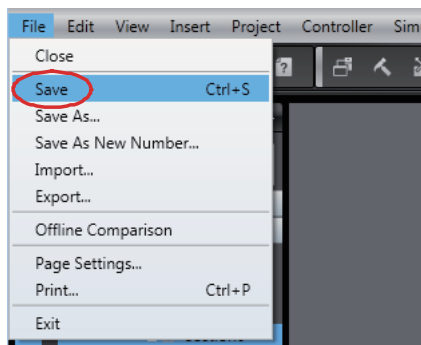

The current project file is saved.

To use a project file on a different computer, export the project file as described in 3-3-7 *Exporting a Project File* on page 3-19.



Additional Information

- Information on synchronization is updated in the project file when synchronization is performed. After you perform synchronization, save the project file before you close it. If you do not save the project file, a message that says that the program execution IDs are different and that all data will be transferred is displayed the next time you perform synchronization.
- If you register any EtherCAT slaves from other manufacturers in a project, the ESI for the slaves is saved in the project file. If you open or import any project that was created on Sysmac Studio version 1.08 or lower, save the project file.

3-3-5 Saving a Project File Under a Different Name

This section describes how to save a project file under a different name.

- 1 Select **Save As** from the **File** Menu.

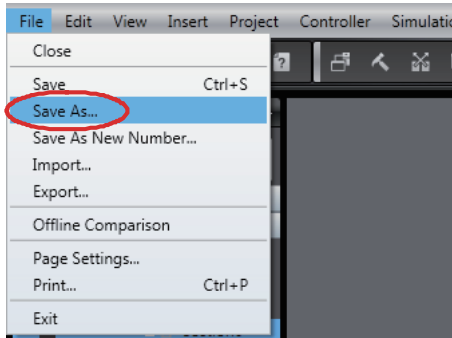

The **Project Properties** Dialog Box is displayed.

- 2 Change the project file name, and then click the **Save** Button.

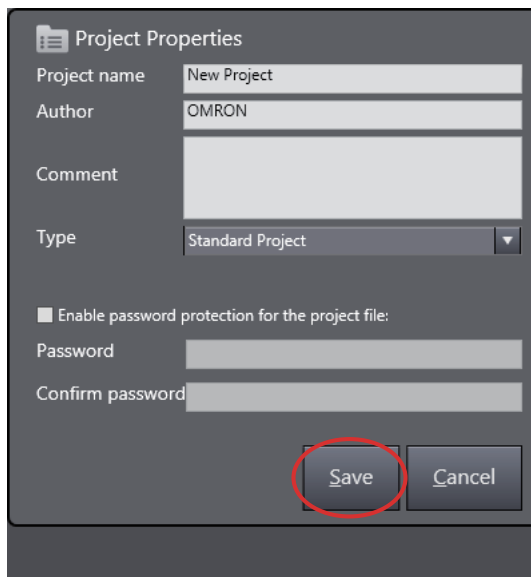

The project file is saved.



Additional Information

Information on synchronization is updated in the project file when synchronization is performed. After you perform synchronization, save the project file before you close it.

If you do not save the project file, a message that says that the program execution IDs are different and that all data will be transferred is displayed the next time you perform synchronization.

3-3-6 Opening a Project File

Use the following procedure to open an existing project file.

- 1 Click **Open Project** on the Start page.

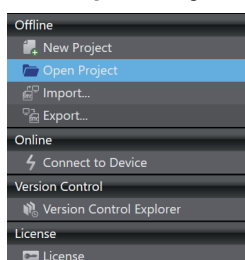

The Project Screen is displayed.

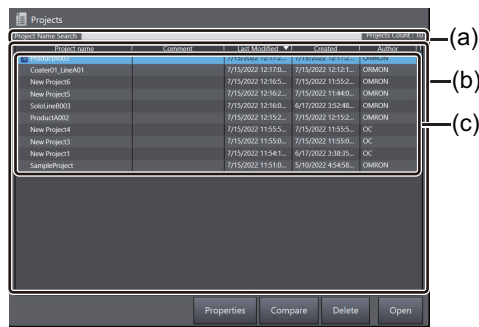

	Item	Description	
(a)	Project Name Search	Enter a text string. Then, the project list will be narrowed to display projects with names that contain the text string you enter. The number of projects that are currently displayed in the project list is displayed to the right.	
(b)	Project list	A list of projects is displayed.	
(c)	Property information*1	Project name	The project names that were entered as a mandatory item when the projects were created are displayed. The default name is <i>NewProject</i> .
		Comment	The comment that was entered when the project was created is displayed.
		Last modified	The last date and time that the project was modified is displayed.
		Created	The date and time that the project was created is displayed.
		Author	The creator that was entered when the project was created is displayed.

*1. You can drag the column headings to change the order of the property items.

2 Select a project from the list of project names and click the **Open** Button.

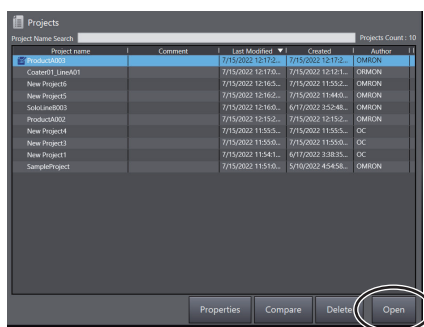

The project is opened.



Additional Information

If you open a project that was created with Sysmac Studio version 1.01 or lower with version 1.05 or higher, a dialog box will appear for you to select the model of the CPU Unit. Select the model of the CPU Unit that is actually connected.

3-3-7 Exporting a Project File

You can use the following methods to export a project file.

Method 1: Exporting from the Start page

Method 2: Exporting from the Menu Bar of the Application Window

● Method 1: Exporting from the Start page

- 1 Select **Close** from the **File** Menu to return to the Start page.
- 2 Click **Open Project** on the Start page.
- 3 Select the project to export from the list of project names and click **Export**.

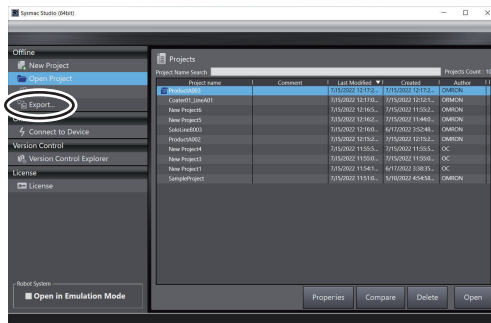

The **Export Project** Dialog Box is displayed.

- 4 Specify a directory, enter a file name, select the file type, and then click the **Save** Button.

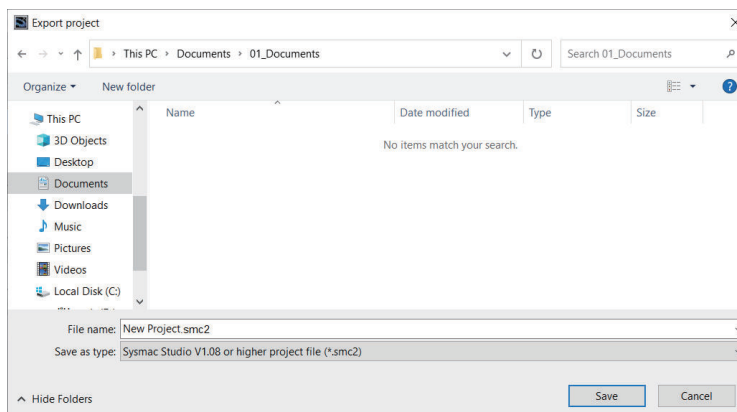

The project is exported to a file.

Extension	Description
smc2*1 or smc	One file contains all of the project data.
csm2*1 or csm*2	One file contains all of the project data. The file is smaller than the smc file. However, the project is always built before the data is transferred to the Controller.

*1. Project files with this extension are supported by Sysmac Studio version 1.08 or higher.

*2. Project files with this extension are supported by Sysmac Studio version 1.04 or higher.



Precautions for Correct Use

The trace data is not included in csm files exported from Sysmac Studio version 1.05 or higher or in csm2 export files. Export any required trace data separately.



Additional Information

- The exported project file has the same contents as a project that was saved on the Sysmac Studio.
- An improved save algorithm in Sysmac Studio version 1.06 or higher exports smaller files than those that are exported from version 1.05 or lower.
- You can export the contents of a project file for which password protection is set. Refer to *3-3-9 Password Protection for Project Files* on page 3-22 for the procedure to set password protection.

● Method 2: Exporting from the Menu Bar of the Application Window

- 1 Select **Export** from the **File** Menu in the Application Window.

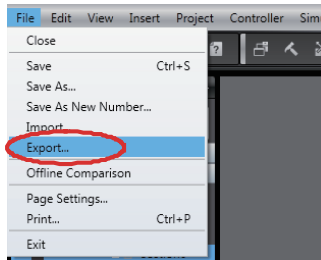

The **Export Project** Dialog Box is displayed.

- 2 Specify a directory, enter a file name, and then click the **Save** Button.
The project is exported to a file.



Precautions for Correct Use

If any EtherCAT slaves from other manufacturers are registered in a project, first save the project file, and then select the smc2 or csm2 format and export the file.
If you import an exported project file to Sysmac Studio version 1.08 and save the project file, the ESI for the slaves is lost.

3-3-8 Importing a Project File

You can use the following methods to import a project file.

Method 1: Importing from the Start page

Method 2: Importing from the Menu Bar of the Application Window

● Method 1: Importing from the Start page

- 1 Click **Import**.

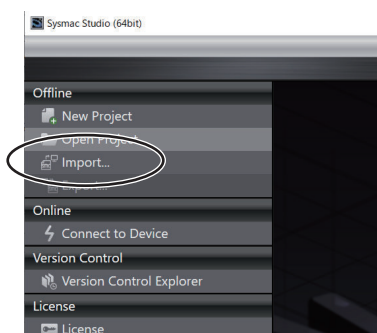

The **Import file** Dialog Box is displayed.

- 2 Select a project file with an .smc2, .csm2, .smc, or .csm file name extension, and then click the **Open** Button.

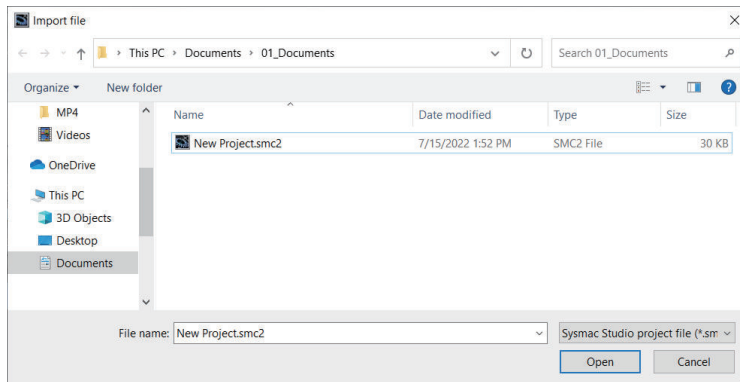

The project file is imported.

● Method 2: Importing from the Menu Bar of the Application Window

- 1 Select **Import** from the **File** Menu in the Application Window.

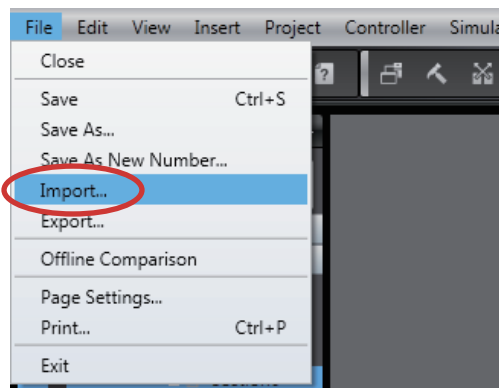

The **Import file** Dialog Box is displayed.

- 2 Select a project file and then click the **Open** Button.
The project file is imported.



Additional Information

If you import a project that was created with Sysmac Studio version 1.01 or lower with version 1.05 or higher, a dialog box will appear for you to select the model of the CPU Unit. Select the model of the CPU Unit that is actually connected.

3-3-9 Password Protection for Project Files

You can set password protection for project files to protect your assets.

If password protection is set, a password is required for the following operations.

- Opening the project file
- Changing the properties of the project file
- Importing the contents of the project file

Setting and Clearing Password Protection for Project Files

The procedures to set and clear password protection are given below.

- 1 Select a project on the Start page. Then, click the **Properties** Button or click the **Edit Properties** icon ().
The **Project Properties** Dialog Box is displayed.
- 2 Select the *Enable password protection for the project file* Check Box, enter the password, and click the **Save** Button. The file is saved.

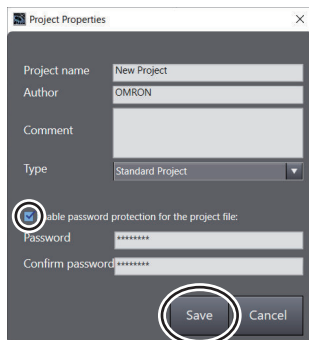

Password protection is now set.

To clear the password protection, clear the selection of the *Enable password protection for the project file* Check Box and click the **Save** Button. The file is saved.



Precautions for Correct Use

- For the password, enter a string of 8 to 32 single-byte alphanumeric characters. The password is case sensitive.
- If you forget the password, you will no longer be able to open the project file, change the properties of the project file, or import the contents of the project file. Be sure to record the password in case you forget it.
- Password protection for project files does not apply to data that is transferred to the Controller. To prevent reading data from the Controller, set operation authorities or data protection.

Opening a Project File for Which Password Protection Is Set

Use the following procedure to open a project file for which password protection is set.

- 1 Click **Open Project** on the Start page.
The Project Screen is displayed.
- 2 Select a project from the list of project names and click the **Open** Button.

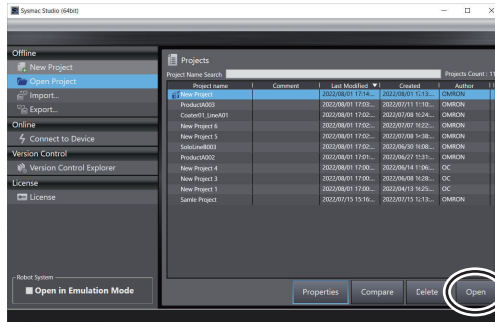

The Enter a password Dialog Box is displayed.

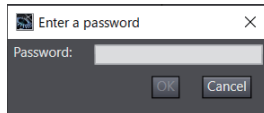



- 3 Enter the password, and click the **OK** Button.
The project is opened.

Changing the Properties of a Project File for Which Password Protection Is Set

Use the following procedure to change the properties of a project file for which password protection is set.

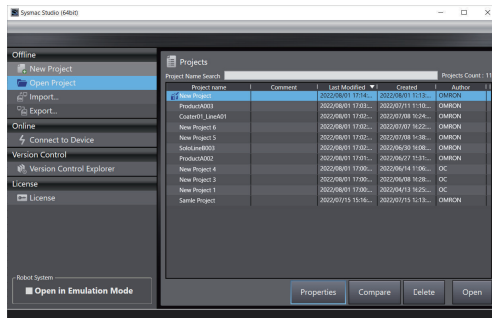
- 1 Select the project file to edit on the Start page.



- 2 Click the **Properties** Button. Or click the **Edit Properties** icon () that appears to the left of the selected project file.
The Enter a password Dialog Box is displayed.

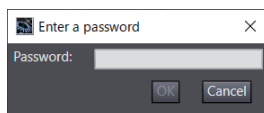

- 3 Enter the password, and click the **OK** Button.
The **Project Properties** Dialog Box is displayed.

Importing a Project File for Which Password Protection is Set

Use the following procedure to import a project file for which a password was set when the project was exported.

1 Click **Import**.

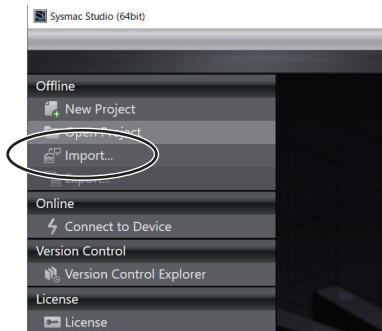

The **Import file** Dialog Box is displayed.

2 Select a project file with an .smc2, .csm2, .smc, or .csm file name extension, and then click the **Open** Button.

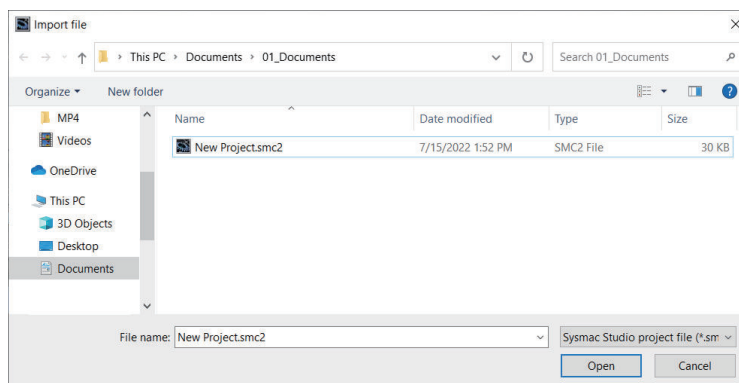

The **Enter a password** Dialog Box is displayed.

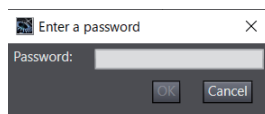

3 Enter the password, and click the **OK** Button. The project file is imported.

3-3-10 Project Update History Management

You can assign numbers to projects to manage the project history. The project numbers are displayed in a hierarchy in the Project Screen.

You can also compare the project between different project numbers offline.

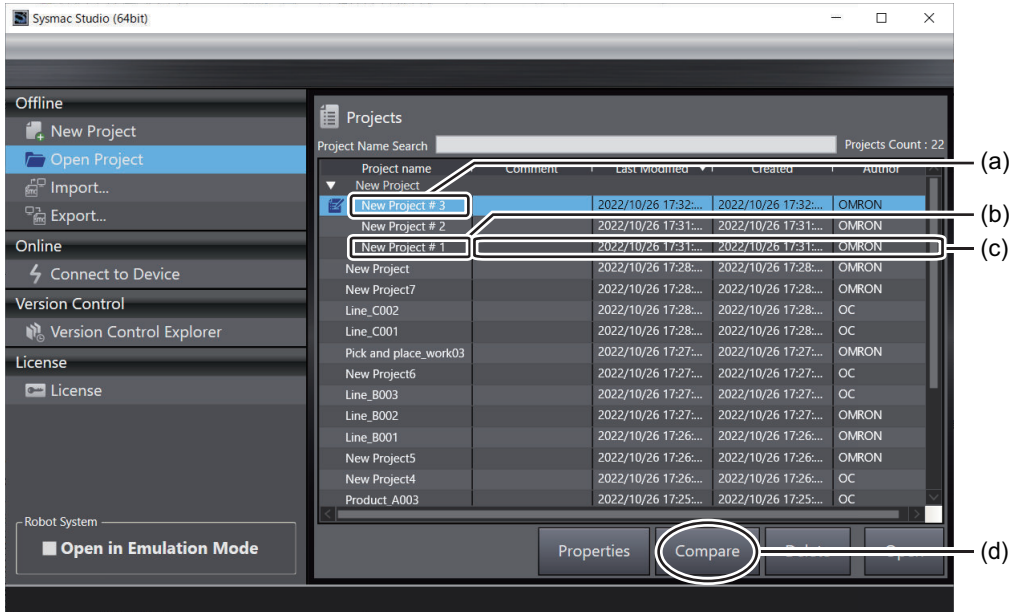

Number	Item	Description
(a)	Newest project	This is the most recent project.
(b)	Project with different project numbers	These are the project versions that were saved when the project number was changed. The project number is automatically added after the project name.
(c)	Properties	The properties of the selected project number are displayed.
(d)	Compare	This button compares the selected projects or different versions of the same project to show the differences. You can merge the differences. Refer to 4-11 Offline Comparison on page 4-180 for the offline comparison and merging procedures.

Saving a Project with a New Project Number

Use the following procedure to save a project with a new project number.

- 1 Select **Save As New Number** from the **File** Menu.

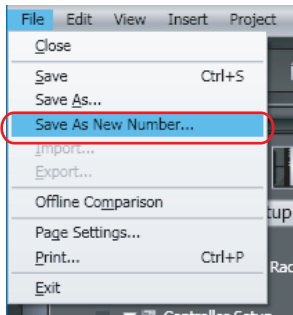

The **Project Properties** Dialog Box is displayed.

- 2 Edit the properties, and then click the **Save** Button.
The project is saved with the most recent project number.

The project number is automatically added to the project that was saved and the project is displayed in a hierarchy for the project.

Project name	Comment	Last Modified	Created	Author
▼ New Project				
📄 New Project # 3		7/21/2017 7:10:54 PI	7/21/2017 7:10:54 PI	oc
📄 New Project # 2		7/21/2017 7:10:48 PI	7/21/2017 7:10:48 PI	oc
📄 New Project # 1		7/21/2017 7:10:45 PI	7/21/2017 7:10:45 PI	oc
📄 New Project		7/21/2017 7:08:34 PI	7/21/2017 7:08:16 PI	oc



Additional Information

- A hierarchy is not displayed for the project when a project is first created or when there is only one project number.
- The project numbers are displayed in order in the hierarchy with the newest project at the top.
- A new number is automatically added for the *project number*. You cannot change the project numbers.
- Project properties are set for each project number.

Opening a Project with a Specific Project Number

Use the following procedure to open a project with a specific project number.

- 1 Select the project with the desired project number from the project hierarchy and click the **Open** Button.

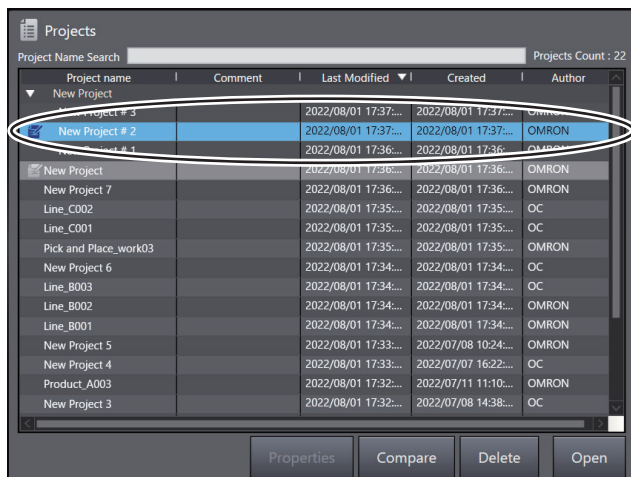

The selected project is opened.



Additional Information

You cannot overwrite a project that was opened for a specific project number. To make changes, either save the project under a different name or save it for the most recent project number.

3-3-11 Creating a Project from an Online Connection

If you go online with the Controller when there is no project, a project is created automatically. You can go online with the Controller and upload the project even if there is no project file on the computer.

Click **Connect to Device**.

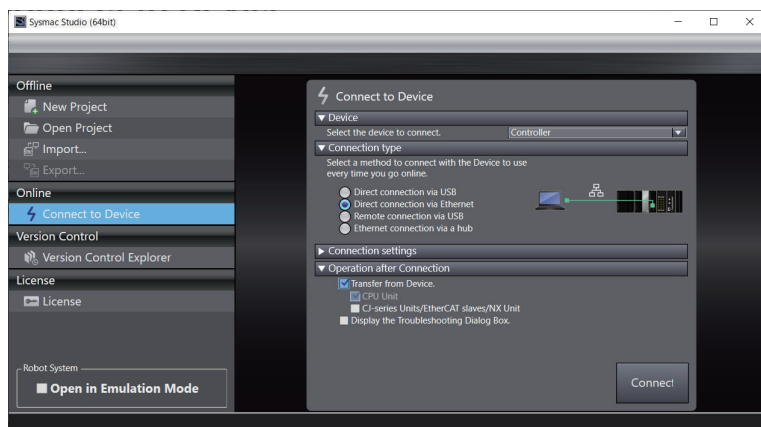

Refer to 6-2-8 *Going Online without a Project* on page 6-9 for the procedure.

3-3-12 Displaying and Registering Licenses

Use the following procedure to check and register licenses.

- 1 Click **License** on the Start page.
The licensed products that are currently registered are displayed.

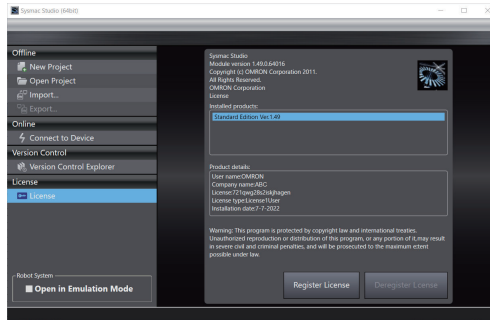

If you click the license in the product name column, detailed information is displayed in the product detailed information column.

The number of days that remains for the trial edition is displayed under **License**.

- 2 To register a new license, click the **Register License** Button.
A License Registration Dialog Box is displayed.

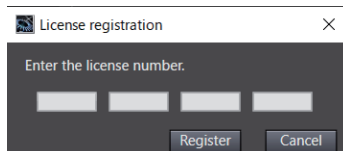

- 3 Enter the license number, and then click the **Register** Button.
If the license is registered normally, a message appears asking you to restart the software.

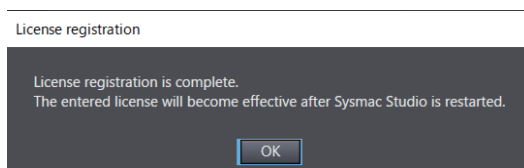

Restart the Sysmac Studio to complete registration.



Precautions for Correct Use

To register a license, you must log onto Windows as a user with administrator rights.

3-3-13 Project Version Control

Use the following procedure to display the version-controlled project list of the Sysmac Studio.

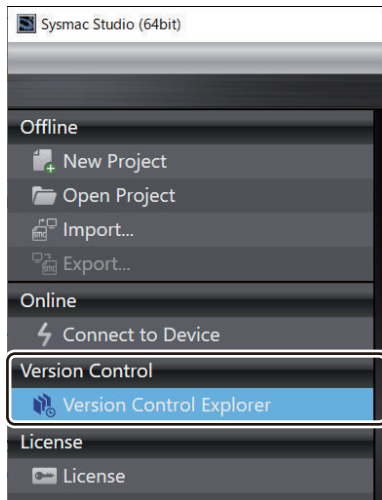

You can use the project version control function to control the changes made to Sysmac Studio projects.

To use the Sysmac Studio project version control function, you need to separately purchase a license of the *Sysmac Studio Team Development Option*.

Refer to the *Sysmac Studio Project Version Control Function Operation Manual (Cat. No. W589)* for details on the Sysmac Studio project version control function.

3-3-14 Project File Management Mode

To manage projects in units of files, select the following check box on the Start page.

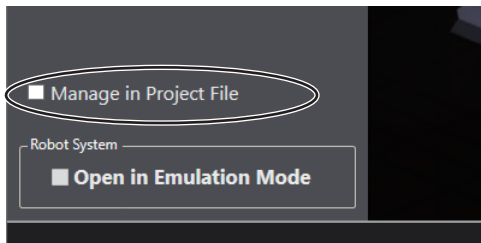

When this function is enabled, the results of edits to a project are saved directly to its project file.

Since the project is handled in units of files, the following functions on the Start page are not available.

Enable or disable the functions as necessary.

- Open Project – Properties
- Open Project – Compare
- Open Project – Delete
- Import
- Export
- Version Control Explorer

When this function is enabled, the save and export functions for projects will work as follows.

Function	Project file management mode	
	Disabled (Not selected)	Enabled (Selected)
Save	Saves the project in the project management area for the Sysmac Studio.	Saves the project file by directly overwriting it. The file before saving will be backed up with the name <i>[project file name].backup</i> . If it is a new project, a Save Project Dialog Box is displayed.
Save As	Saves the project with a different name in the project management area for the Sysmac Studio.	Saves the project file with a different name.
Save As New Number	Saves the project in the project management area for the Sysmac Studio with a new project number.	Not available
Export	Saves the project in the project management area for the Sysmac Studio as a project file.	Not available



Precautions for Correct Use

- If a project file is large or if an opened file is on a network, it may take time to save the project.
- If you open a project in the project management area for the Sysmac Studio, disable the project file management mode.

3-4 Parts of the Window

This section gives the names, functions, and basic arrangement of the parts of the Sysmac Studio Window.

You can change the display locations of the parts of the window. Refer to *3-4-5 Changing the Display Location of Window Parts* on page 3-44 for detailed procedures.

3-4-1 Application Window

This is the main Sysmac Studio window.

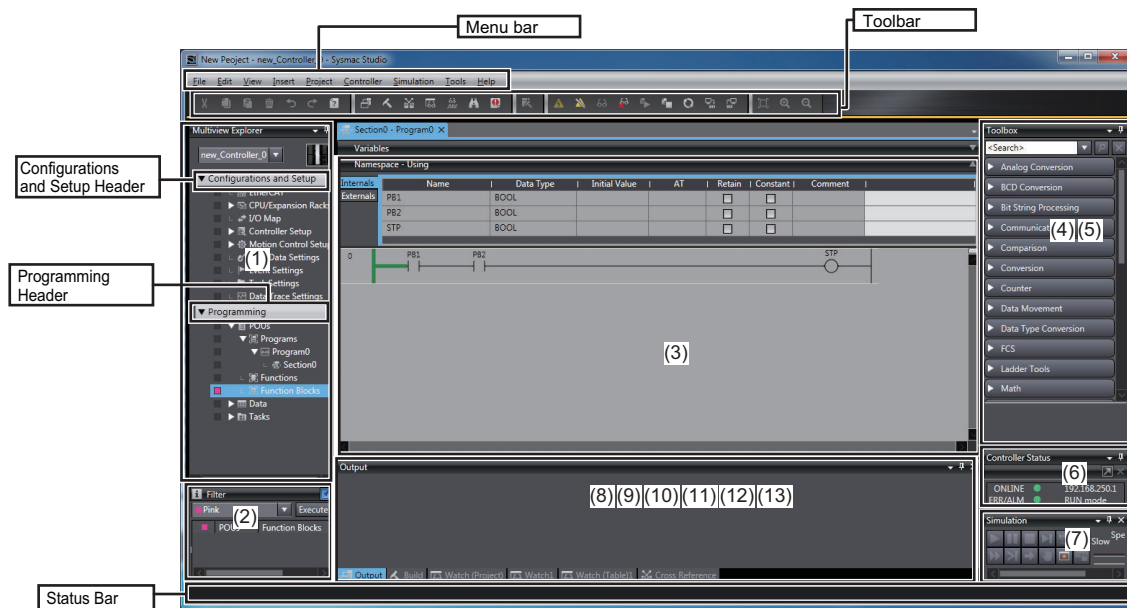

Number	Name
(1)	Multiview Explorer
(2)	Filter Pane
(3)	Edit Pane
(4)	Toolbox
(5)	Search and Replace Pane
(6)	Controller Status Pane
(7)	Simulation Pane
(8)	Cross Reference Tab Page
(9)	Output Tab Page
(10)	Watch Tab Page
(11)	Build Tab Page
(12)	Search and Replace Results Tab Page
(13)	Differential Monitor Tab Page

Hiding/Showing the Menu Bar, Toolbar, and Status Bar

You can hide or show the menu bar, toolbar, and status bar.

Right-click the title bar in the main window and select the items to display from the menu. Checkmarks will appear by them. To hide the items, select them again. The checkmarks will disappear.

You can also press the Alt Key to display the menu bar when it is hidden.

3-4-2 Multiview Explorer (1)

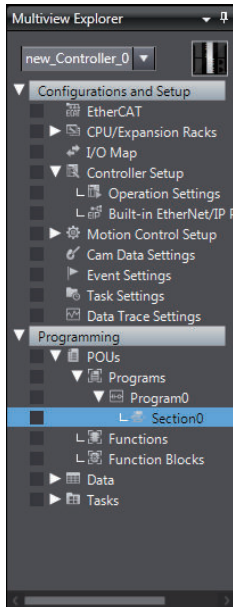

- This pane is your access point for all Sysmac Studio data. It is separated into **Configurations and Setup** and **Programming**. Each of these is displayed in a tree structure.
- Click the icons (▶ or ▼) in front of each item in the tree to expand or collapse the tree.
- A pop-up menu is displayed if you right-click any data items that can be set.

● Items in the Multiview Explorer

Configurations and Setup	Programming
EtherCAT	POUs
CPU/Expansion Racks	Programs
CPU Rack	Functions
Expansion Racks	Function Blocks
I/O Map	Data
Controller Setup	Data Types
Operation Settings	Global Variables
Built-in EtherNet/IP Port Settings	Tasks
Motion Control Setup	
Axis Settings	
Axes Group Settings	
Cam Data Settings	
Event Settings	
Task Settings	
Data Trace Settings	

Device List and Device Icon for the Project

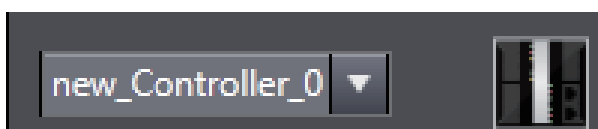

Use this list and icon to switch the device to edit and add/delete devices.

● Device List

Devices that are registered in the project are displayed.

Select the device to edit in the device list and configure the device or create a program.

You can display the device list in either of the following two ways.

Right-click the device icon and select **Switch Device Control Display** from the pop-up menu, or click the device icon to toggle the display.

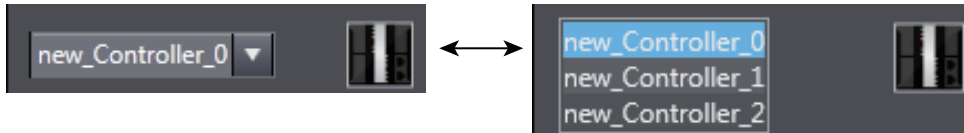

● Device Icon

The icon for the device that is selected in the device list is displayed.

You can add or change devices, or switch the display method of the device list in the pop-up menu that appears when you right-click the device icon.

Color Codes

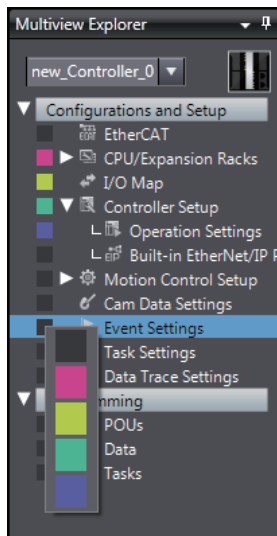

You can display marks in five colors on the categories and members of the Multiview Explorer.

You can define how you want to use these marks, e.g., to indicate data development status or developer assignments. You can also use them as filter conditions in the Filter Pane that is described later in this section.

Error Icons

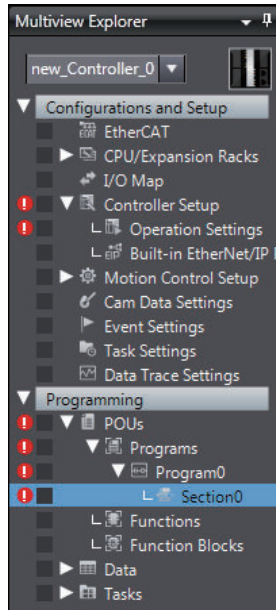

The error icon indicates when there is an error in the edited data.

Click this icon to display the item with the error in the Edit Pane.



Precautions for Correct Use

You cannot download the data to the NJ/NX/NY-series Controller if an error icon is displayed.

Filter Pane (2)

The Filter Pane allows you to search for color codes and for items with an error icon. The results are displayed in a list. Click the Filter Pane Bar to display the Filter Pane. The Filter Pane is hidden automatically if the mouse is not placed in it for more than five seconds at a time. Automatically hiding the

Filter Pane can be canceled by clicking the pin () icon.

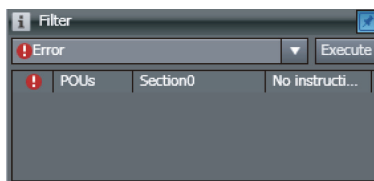

You can search for only items with a specific color code or items with error icons to display a list with only items that meet the search condition. This allows you to edit multiple items from a single list. Click any item in the search result to display the item in the Edit Pane.

3-4-3 Edit Pane (3)

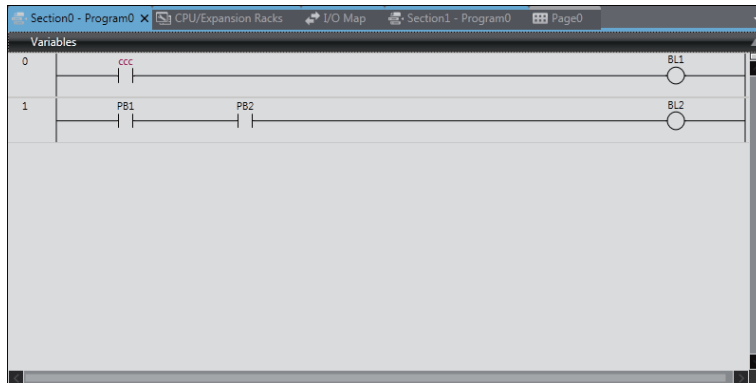

The Edit Pane is used to display and edit the data for any of the items.

Double-click an item in the Multiview Explorer to display details of the selected item in the Edit Pane. The Edit Pane is displayed as tab pages, and you can switch the tab page to display in the Edit Pane by clicking the corresponding tab.

You can undock the Edit Pane from the main window. Refer to 3-4-5 *Changing the Display Location of Window Parts* on page 3-44 for details.



Additional Information

- You can use an option setting to change the number of tab pages in the Edit Pane that can be displayed at a time. The default setting is 10, and the maximum display number is 20. Also, you can set so that an old tab page that has not been used is closed automatically when the maximum display number is exceeded. Refer to 8-26 *Sysmac Studio Option Settings* on page 8-166 for details on the settings.
- When you perform any of the following operations, all Edit Panes of the devices that you are not working on will automatically close.
 - a) Online editing
 - b) Synchronization
 - c) Running the Simulator
 - d) Setting the Setting Change during RUN Mode parameter in the Controller Setup
 - e) Uploading data tracing results
 - f) Displaying the **Troubleshooting** Dialog Box
 - g) Transferring all Controller data
 - h) Starting data tracing
- You can close the Edit Pane from the pop-up menu that appears when you right-click one of the tabs.

Menu command	Description
Close All But This	Select this command to close all tab pages and floating edit windows, except for the selected tab page.
Close All Except Active Device	Select this command to close all tab pages and floating edit windows for other devices, leaving those for the selected device.
Close All	Select this command to close all tab pages and floating edit windows, including the selected tab page.

● Display Color of Each Tab

The color of each tab in the Edit Pane indicates the selection status of both the tab page and the device.

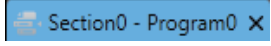
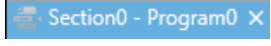
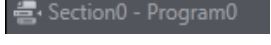
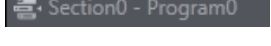
Tab page	Device	Display	Description
Selected	Selected		Both the tab page and the device are selected. A tab changes to this state when it is clicked.
	Not selected		The tab page is selected and it is for a device that is not selected in the device list.
Not selected	Selected		The tab page is not selected and it is for the device that is selected in the device list.
	Not selected		The tab page is not selected and it is for a device that is not selected in the device list.

● Creating a Tab Group

When more than one tab page exists in the Edit Pane, you can click any of the tabs to switch the tab page displayed in the Edit Pane. Such a group of tabs that you can click to switch the displayed tab page is called *tab group*.

By creating *tab groups*, you can organize and manage more than one tab page.

To create a tab group, right-click any of the tabs to display the pop-up menu.

Menu command	Description	Remarks
New Horizontal Tab Group	Select this command to divide the Edit Pane into upper and lower sections and move the selected tab page to the tab group that is newly created.	You can display the pop-up menu when the current tab group has more than one tab page.
New Vertical Tab Group	Select this command to divide the Edit Pane into left and right sections and move the selected tab page to the newly created tab group.	You can display the pop-up menu when the current tab group has more than one tab page.
Move to Next Tab Group	Select this command to move the selected tab page to the tab group below or to the right of the current tab group.	You can display the pop-up menu when there is a tab group below or to the right of the current tab group.
Move to Previous Tab Group	Select this command to move the selected tab page to the tab group above or to the left of the current tab group.	You can display the pop-up menu when there is a tab group above or to the left of the current tab group.



Additional Information

- You can group tab pages only when the Edit Pane has tab pages.
- You can also move tab pages between tab groups by dragging the mouse. Refer to *Docking and Undocking* on page 3-44 for the procedure.

Smart Project Search

You can search the Multiview Explorer for the items you want to display.

When there are a large number of programs or sections registered in the Multiview Explorer, you can quickly display the desired program or section by searching for it.

- 1 Select **Smart Project Search** from the **View** Menu. Or, press the Ctrl + Shift + F Keys. The Smart Project Search Dialog Box is displayed.

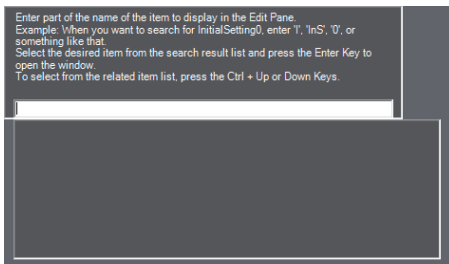

- 2 Enter in the Search Box part of the name of the item to display in the Edit Pane. The items in the Multiview Explorer or menus that contain the entered text string are displayed on the left side of the search result list.

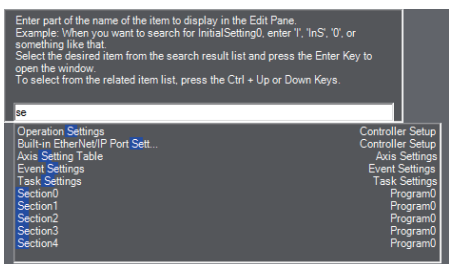

The search results are displayed from the top in the order they are displayed in the Multiview Explorer.

On the right side of the search result list, the level that is one higher than the item that resulted from the search is displayed.

- 3 Double-click the desired item in the search result list. Or, press the Enter Key. The Search Dialog Box is closed and the selected item is displayed in the Edit Pane. To close the Search Dialog Box without selecting an item, click in a pane other than the Search Dialog Box or press the Esc Key.



Additional Information

- You can enter English characters into the Search Box to search for item names that contain words that start with the entered characters in capitals.
 Example: If you enter *is0* in the Search Box, an item named *InitialSetting0* is displayed in the search result list.
- You can search for the items displayed in the Edit Pane when online only when the Sysmac Studio is online.

● Related Item List

If you search for a section or cam definition in the Search Dialog Box, any other sections or cam definitions that are in the same level as the sections and cam definitions in the search results are displayed. This allows you to quickly check the sections and cam definitions that are related to the item that you searched for.

The following procedure uses a search for a section as an example. The procedure for searching for cam definitions is essentially the same.

- 1 Select a section that is displayed in the search result list.
 If there are any other sections in the program to which the selected section belongs, a related item list is displayed to the right side of the search result list.

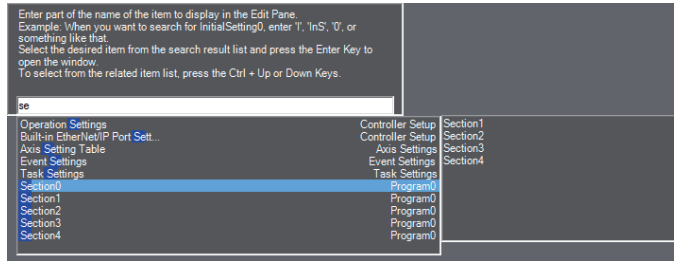

All of the other sections that are at the same level as the selected section are displayed.

- 2 Double-click the desired section in the related item list. Or, press the Ctrl + Up or Ctrl + Down Keys to select the section and then press the Enter Key.
The related item list and Search Dialog Box are closed and the selected section is displayed in the Edit Pane.

Displaying Recently Closed Windows

For the currently selected device, you can display a thumbnail index of the windows that were previously displayed in the Edit Pane, and you can select a window from the thumbnail index to display it again.

- 1 Select **Recently Closed Windows** from the **View** Menu. Or, press the Ctrl + Shift + H Keys.
The windows previously displayed in the Edit Pane are displayed in the thumbnail index of recently closed windows.

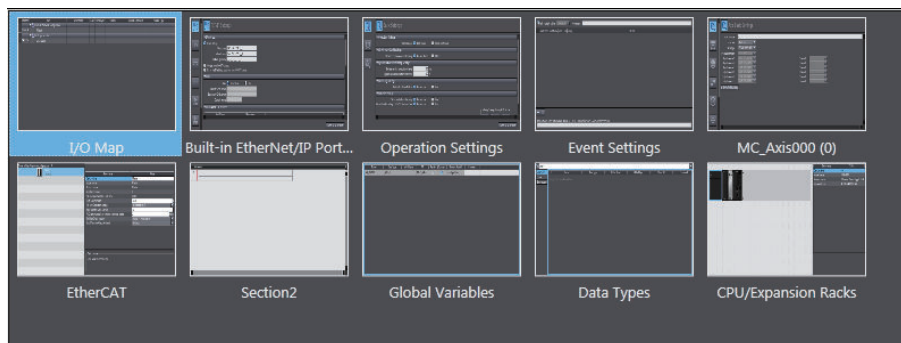

The thumbnails of up to the 20 most recently closed windows are displayed in the order they were closed from the upper left to the bottom right.

Select the window to display with the mouse or the Arrow Keys. You can select more than one window if you click the windows while you hold down the Shift or Ctrl Key or if you press the Arrow Keys while you hold down the Shift or Ctrl Key.

- 2 Double-click the window to display. Or, press the Enter Key.
The thumbnail index is closed and the selected window is displayed in the Edit Pane.
To close the thumbnail index without selecting a window, click in a pane other than the thumbnail index or press the Esc Key.



Additional Information

- The history of recently closed windows is retained for each device.
- If data of a window is protected, a blank thumbnail is displayed for the window in the index of windows. These windows are not displayed in the Edit Pane even if you double-click them.
- If you upload data from a different device, the history of recently closed windows from the device that was displayed before the upload is cleared.

● Clearing the Histories of Recently Closed Windows

You can delete all of the histories of recently closed windows from a project.

Select **Clear Recently Closed Windows History** from the **View** Menu, and then click the **Yes** Button in the confirmation dialog box that is displayed. All of the histories are deleted.

Jumping to the Multiview Explorer

From the selected tab page in the Edit Pane, you can jump to the relevant location in the Multiview Explorer.

- 1 Select the target tab page in the Edit Pane and right-click on it, and select **Jump to Multiview Explorer** from the pop-up menu, or select **Jump to Multiview Explorer** from the **Edit** Menu. Or, select the tab page in the Edit Pane and press the Shift + Alt + L Keys.

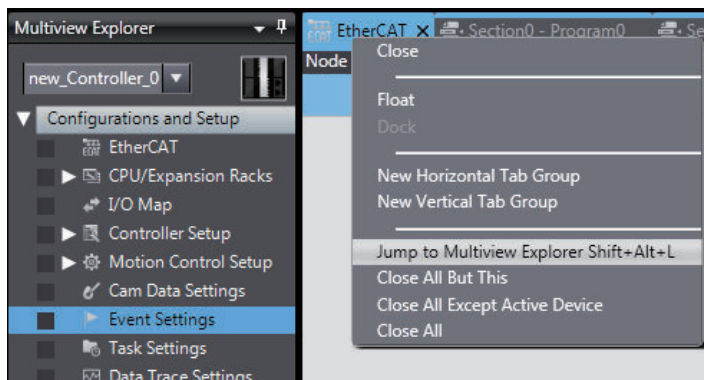

The focus moves to the relevant location in the Multiview Explorer.

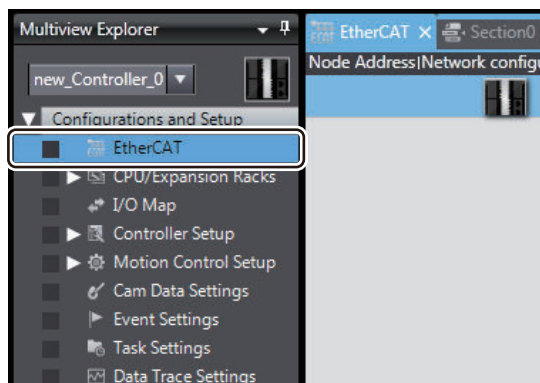

3-4-4 Toolbox (4)

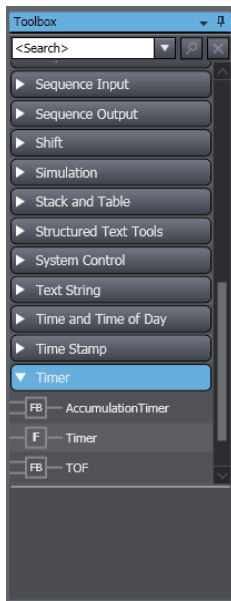

The Toolbox shows the objects that you can use to edit the data that is displayed in the Edit Pane.

The contents for the items displayed in the Edit Pane are displayed.

You can expand or omit the display of objects by selecting **Expand All** or **Collapse All** from the pop-up menu.

Search and Replace Pane (5)

In the Search and Replace Pane, you can search for and replace strings in the data under Programming in the Multiview Explorer.

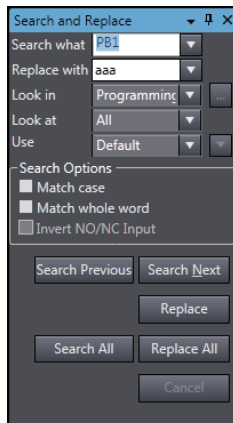

Controller Status Pane (6)

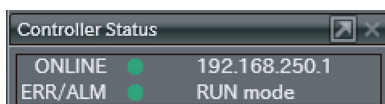

The Controller Status Pane shows the current operating status of the Controller. The Controller Status Pane is displayed only while the Sysmac Studio is online with the Controller.



Additional Information

The Controller Status Pane is not displayed when the Sysmac Studio is offline.

Simulation Pane (7)



The Simulation Pane is used to set up, start, and stop the Simulator for the Controller.



Additional Information

The Simulation Pane is not displayed when the Sysmac Studio is online with the Controller.

Cross Reference Tab Page (8)

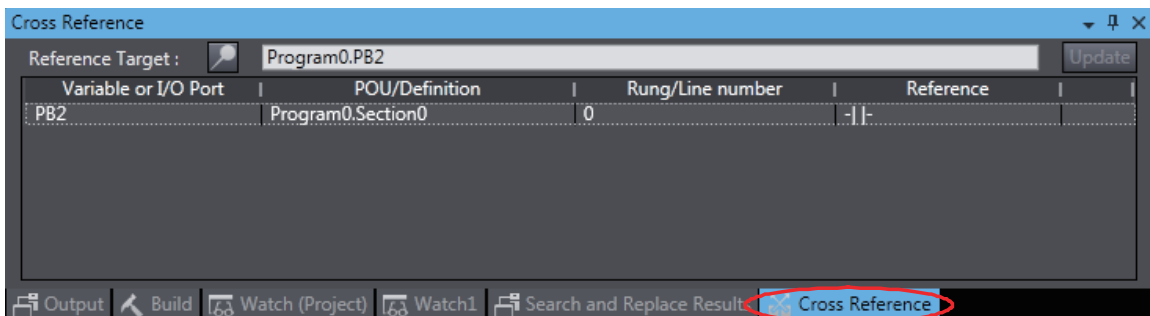

A Cross Reference Tab Page displays a list of where variables, data types, I/O ports, functions, and function blocks are used in the Sysmac Studio.

You can select a variable or other item in the Ladder Editor or a variable table to display a list of the locations where the item is used.

You can click any of the items in the list to jump to the location where the item is used.

Output Tab Page (9)

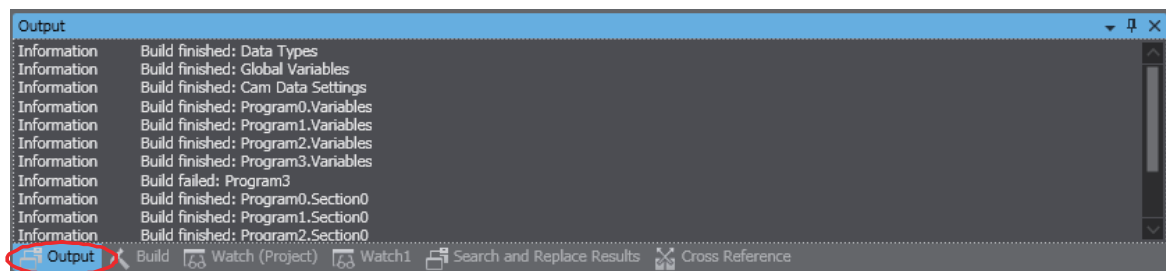

The Output Tab Page shows the results of building.

Watch Tab Page (10)

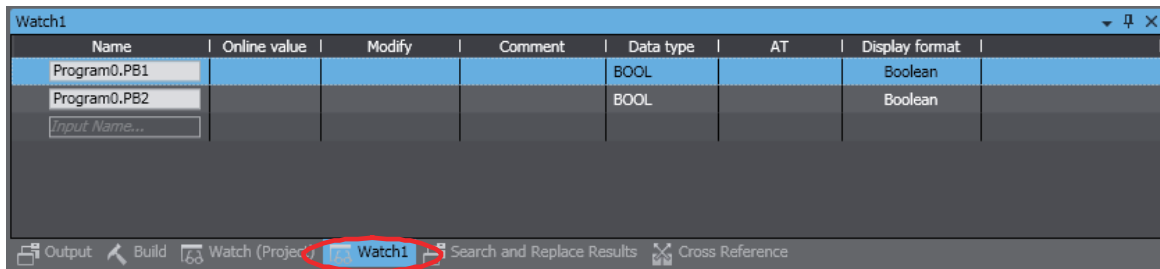

The Watch Tab Page shows the monitor results of the Simulator or online Controller.

You can monitor the current values of variables by inputting the variables directly or by dragging them from a variable table or program rung.

Build Tab Page (11)

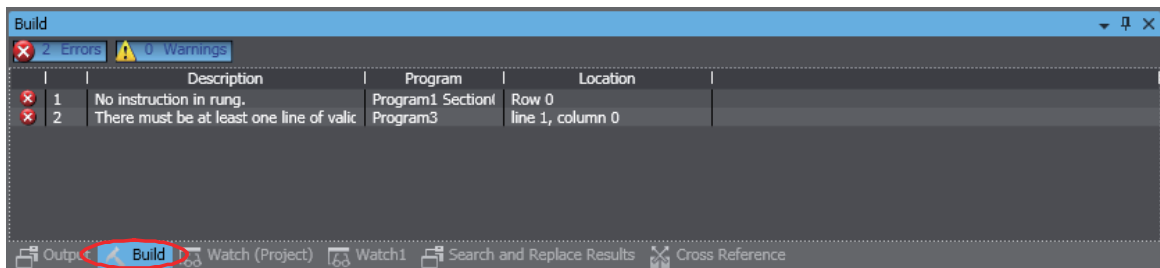

The Build Tab Page shows the results of program checks and building.

Double-click any of the results to display the location of the program check error, program check warning, or building error in the Edit Pane of the Sysmac Studio so that you can edit it.

Search and Replace Results Tab Page (12)

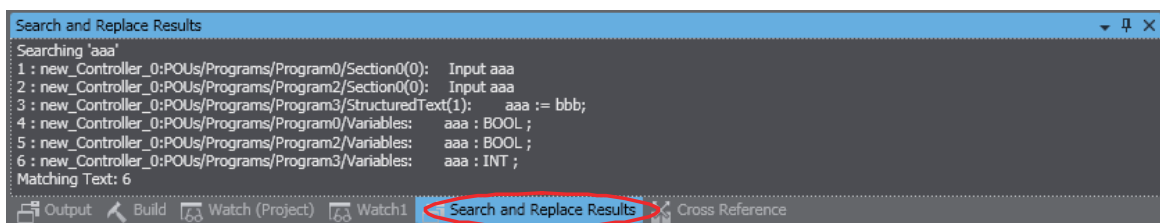

The Search and Replace Results Tab Page shows the results when **Search All** or **Replace All** is executed.

Double-click any of the search/replace results to display the location in the Edit Pane of the Sysmac Studio so that you can edit it.

Differential Monitor Tab Page (13)

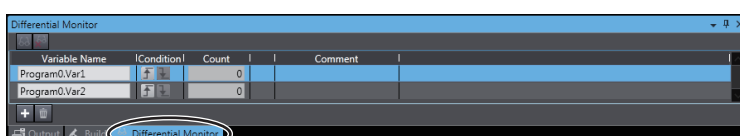

You can detect the number of times the specified BOOL variable or BOOL member changes to TRUE or FALSE and display the count in this tab page.

You can check if bits turn ON and OFF and the number of times that they turn ON and OFF.

3-4-5 Changing the Display Location of Window Parts

You can change the positions of the parts of the main Sysmac Studio window. You can also hide and display parts of the window.

Docking and Undocking

You can undock the Edit Pane, Watch Tab Pages, and other window parts from the main Sysmac Studio window and position them as desired. You can dock windows into tab groups.

Undocking is when you separate a part of the main window. Docking is when you join a window as a part of the main window again. A window that was separated from the main window is called a floating window. A window that is docked with the main window is called a docked window.

● Undocking Parts of the Window

- 1 Click and drag the title bar of a pane or the tab of a tab page. Docking guides are displayed.

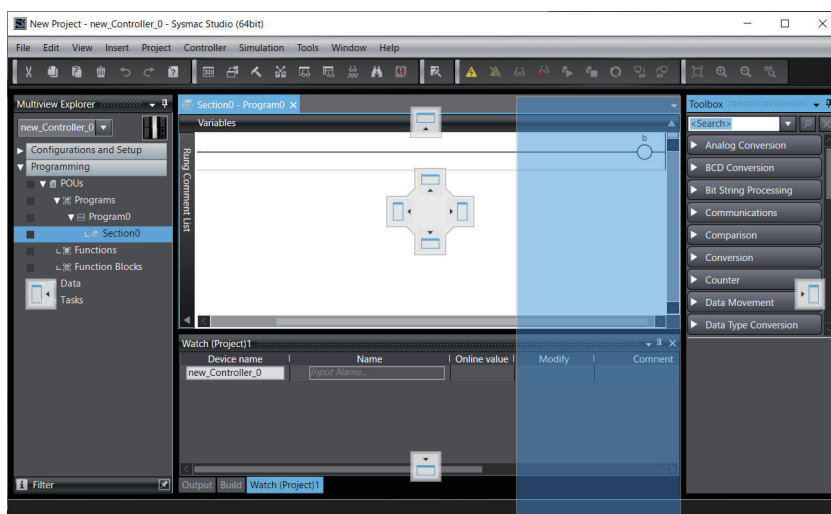

- 2 Release the mouse button when the pane or tab page is at any location other than the docking guides. The pane or tab page will become a floating window.

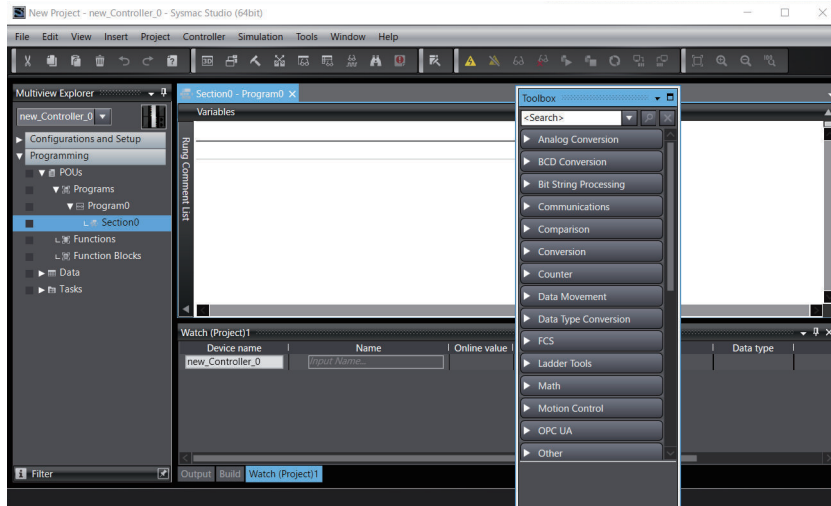

● Docking Windows

- 1 Click and drag the title bar of the window or the tab of a tab page. Docking guides are displayed in the locations where you can dock the window or tab page. The docking guide icons that are displayed depend on the position of the mouse cursor. The icons that are displayed are shown in the following table.

Icon	Description
	The window or tab page that you drag is aligned vertically or horizontally with the object where the icon is displayed.
	The window or tab page that you drag is placed in a tab group with the object where the icon is displayed.

When you align the mouse cursor with a docking guide icon, a blue shaded area is displayed in the window docking position.

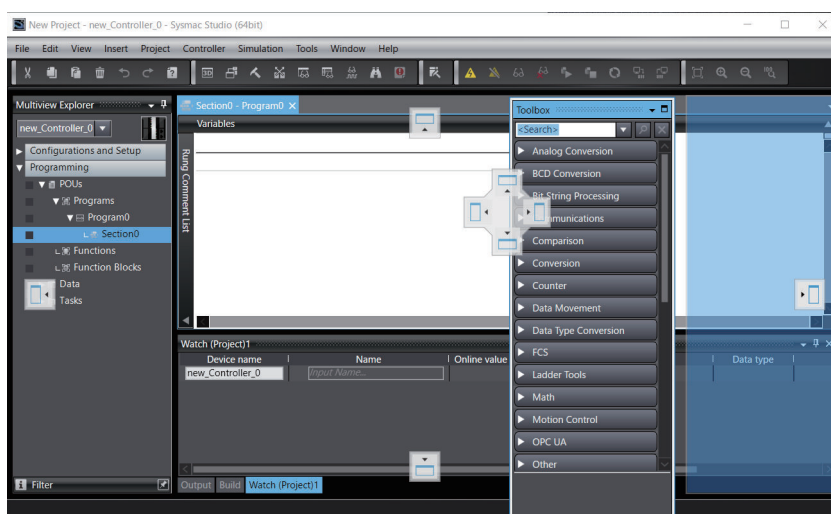

- 2 Align the mouse cursor with any of the docking guide icons and release the mouse button. The window is positioned at the docking position with the blue shaded area.

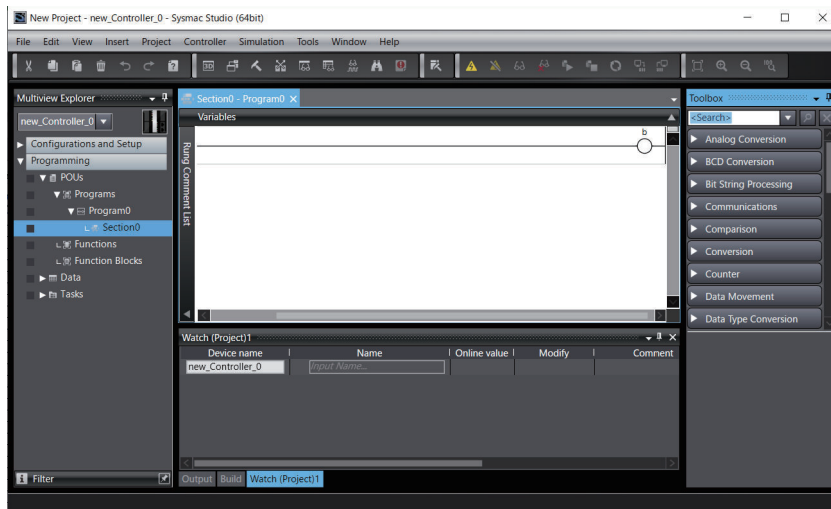

Windows are classified into the following two groups depending on where you can dock the windows.

Window group	Target object	Dockable locations
Edit windows	Tab pages in the Edit Pane	Edit Pane
Tool windows	Multiview Explorer	Any tool window or anywhere in the main window except for the Edit Pane
	Toolbox	
	Search and Replace Pane	
	Watch Tab Page	
	Controller Status Pane	
	Simulation Pane	
	Output Tab Page	
	Build Tab Page	
	Cross Reference Tab Page	
	Search and Replace Results Tab Page	
Differential Monitor Tab Page		

Here, “tool windows” refers to the window group of panes and tab pages that are not displayed in the Edit Pane.

You can place windows that are in the same group into tab groups.



Additional Information

- When you drag a tool window, you can horizontally or vertically align it or overlap it in a tab group with not only the main window, but also with other floating tool windows.
- You can group tab pages in the Edit Pane from the pop-up menu that appears when you rightclick one of the tabs.
- You can use the following methods to switch between a floating and docked window.
 - a) Double-click the title bar of the window/pane or the tab of the tab page.
 - b) Right-click the title bar or tab and select **Float/Dock** from the menu.
- For the currently selected pane, the upper part of the title bar is displayed in light blue.

● Moving the Focus between Objects

You can use the Ctrl+Tab Keys to move the focus between windows, panes, and tab pages.

- 1 Press the Ctrl+Tab Keys when an edit window or a tool window is active. The Change Display Dialog Box is displayed.

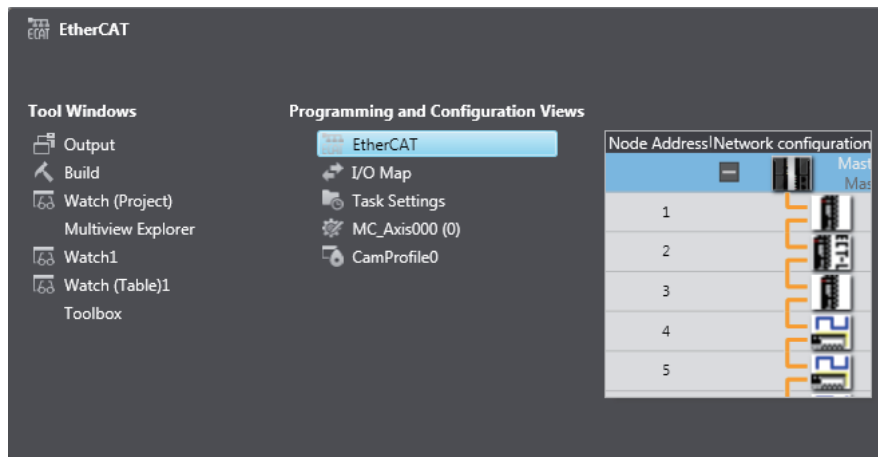

- 2 Hold down the Ctrl Key and press the Tab Key or an Arrow Key to select the desired object name. When you release the key, the Change Display Dialog Box is hidden and the focus moves to the selected object.

● Restoring the Default Window Layout

You can restore the window layout to the Sysmac Studio default layout. Select **Reset Window Layout** from the **View Menu**.

Displaying/Hiding Docked Windows

You can hide and display the tool windows in the main window. The following procedure uses the Toolbox as an example.

- 1 Click the Pin Button on the Toolbox.

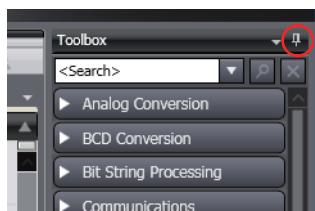

The Toolbox is hidden and a Show/Hide Tab is displayed on the closest adjacent edge of the main window.

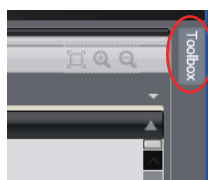

If you move the mouse cursor over the Show/Hide Tab, the Toolbox is displayed. When you move the cursor off the Show/Hide Tab, the Toolbox is hidden again.

- 2 To display the Toolbox again, click the Show/Hide Tab and then click the horizontal Pin Button.

3-4-6 Saving and Restoring the Window Layout

You can save the display positions of window parts that make up the Sysmac Studio main window (hereinafter called window layout) on your computer and restore the window layout based on the information.

The following functions are available for saving and restoring the window layout.

Function	Description
Automatic Window Layout Saving and Restoration	The window layout is automatically saved to your computer when you close a project. The saved window layout is automatically restored when you open the project.
Window Layout Template Management	The currently displayed window layout is saved as a template. Saved templates are displayed in a list. You can select any template from the list and then change the layout of the displayed window.

Saving and restoring the window layout support all window parts except for the following.

- Toolbar
- Filter Pane
- Edit Pane

Refer to *3-4-1 Application Window* on page 3-32 for details on the window parts.

Automatic Window Layout Saving and Restoration

You can choose whether to manage the window layout information for each project or as common for all projects. Change the management method in the option settings. Refer to *8-26 Sysmac Studio Option Settings* on page 8-166 for details on the option settings.

Window Layout Template Management

Manage the window layout in the **Window Layout Template Management** Dialog Box.

- 1 Select **Manage Window Layout Templates** from the **View** Menu.
The **Window Layout Template Management** Dialog Box is displayed.

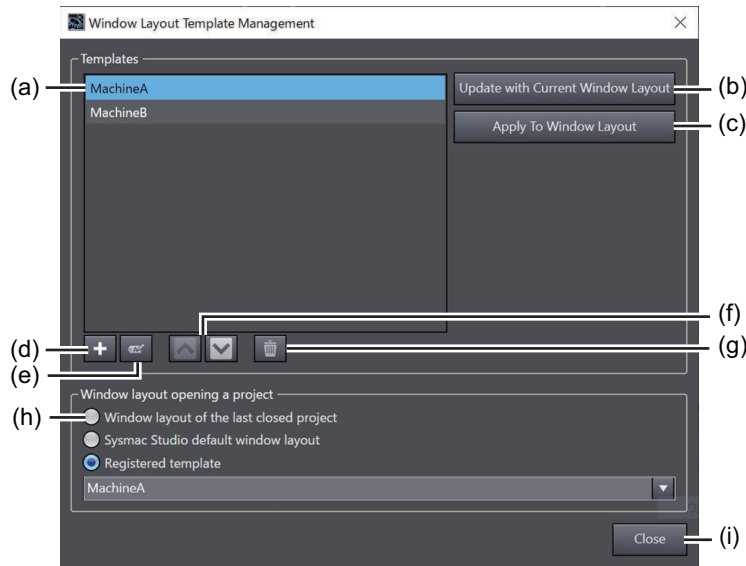

No.	Item	Description
(a)	Templates	A list of registered window layout templates is displayed.
(b)	Update with Current Window Layout Button	Use this button to update the selected window layout template with the currently displayed window layout.
(c)	Apply To Window Layout Button	Use this button to apply the selected window layout template to the currently displayed window layout.
(d)	Create New Template Button	Use this button to create a new template. Save the currently displayed window layout with any name.
(e)	Rename Button	Use this button to rename the selected template.
(f)	Up Button and Down Button	Use these buttons to move the selected template up and down to change the display order of templates.
(g)	Delete Button	Use this button to delete the selected template.
(h)	Window layout opening a project	Set the window layout to apply to the project that you open. This setting is displayed only when you select <i>Save/restore the window layout as the common setting with all projects</i> in the option settings. Refer to 8-26 <i>Sysmac Studio Option Settings</i> on page 8-166 for details on the option settings.
	Window layout of the last closed project	Select this option to open the project with the window layout of the last closed project.
	Sysmac Studio default window layout	Select this option to open the project with the default window layout.
	Registered template	Select this option to open the project with the window layout of a registered template. Select the window layout to apply to the project from the registered templates.
(i)	Close Button	Use this button to close the Window Layout Template Management Dialog Box.

● **Registering a New Template**

Use the following procedure to register the currently displayed window layout as a template.

- 1** In the **Window Layout Template Management** Dialog Box, click the **Create New Template** Button.

The **Create New Template** Dialog Box is displayed.

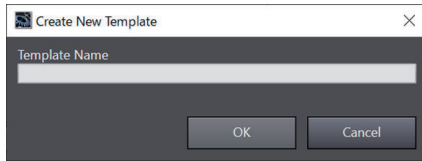

- 2 Enter a name in the **Template Name** box, and then click the **OK** Button.
The currently displayed window layout is saved and registered as a new template.

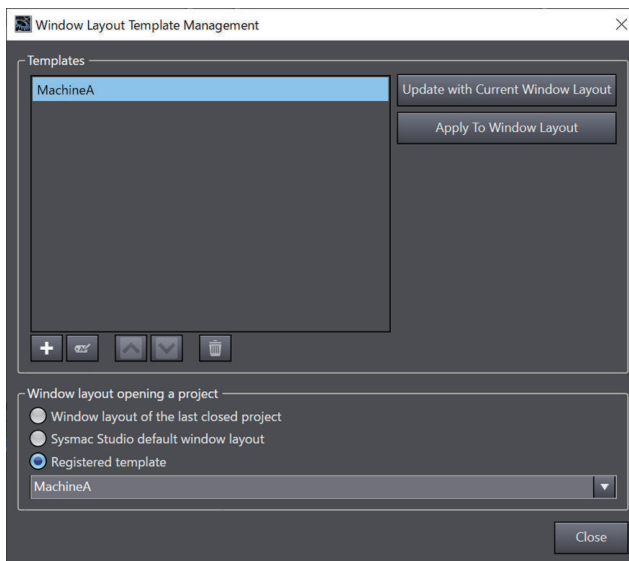

● Updating a Window Layout Template

Use the following procedure to update a registered window layout template with the currently displayed window layout.

- 1 In the **Window Layout Template Management** Dialog Box, select the template to update, and then click the **Update with Current Window Layout** Button.

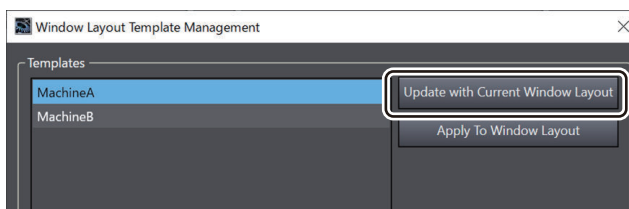

An update confirmation dialog box is displayed, which asks if you want to apply it.

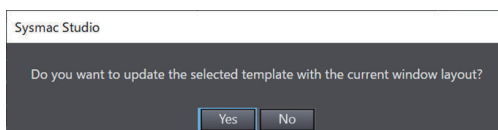

Clicking the **Yes** button updates the target template with the currently displayed window layout.

● Applying a Window Layout Template

Use the following procedure to apply a registered window layout template to the currently displayed window layout.

- 1 In the **Window Layout Template Management** Dialog Box, select the template to apply to the currently displayed window layout, and then click the **Apply To Window Layout** Button.

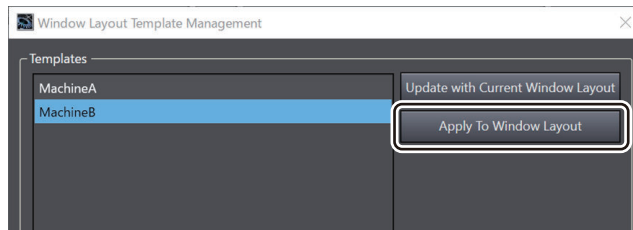

A confirmation dialog box is displayed, which asks if you want to apply it.

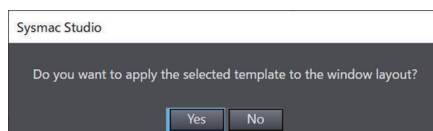

Clicking the **Yes** button displays the currently displayed window using the selected window layout template.



Additional Information

- This function can be used only in a standard project.
- The automatic window layout saving and restoration functions can be used simultaneously.

3-5 Menu Command Structure

The menu commands that are always displayed when a Controller is selected are listed below. Menu commands that you cannot use are grayed out.

For specific device menu commands, refer to the manual for the specific device.

Menu	Submenu/command	
File	Close	---
	Save	
	Save As	
	Save As New Number	
	Import	
	Export	
	Offline Comparison	
	Page Settings	
	Print	
	Project Properties	
	Exit	
Edit	Undo	---
	Redo	
	Cut	
	Copy	
	Paste	
	Delete	
	Select All	
	Search and Replace	
	Find Previous	
	Find Next	
	Jump	
	Jump to Multiview Explorer	

Menu	Submenu/command	
View	Multiview Explorer	---
	Toolbox	
	3D Visualizer	
	Output Tab Page	
	Watch Tab Page	
	Watch Tab Page (Table)	
	Cross Reference Tab Page	
	Build Tab Page	
	Search and Replace Results Tab Page	
	Simulation Pane	
	Differential Monitor	
	Variable Table	
	Variable Manager	
	Smart Project Search	
	Recently Closed Windows	
	Clear Recently Closed Windows History	
	Zoom	Zoom In
Zoom Out		
Zoom to Fit		
Zoom Reset		
Manage Window Layout Templates	---	
Reset Window Layout		
Insert	Circuit Parts	Line
		N.O. Input
		N.C. Input
		OR with N.O. Input
		OR with N.C. Input
		Output
		NOT Output
		Function Block
	Derive Device	Share All Programming Data
		Share Shared Programming Data
	Controller	NJ101
		NJ301
		NJ501
		NX1P2
		NX102
		NX502
		NX701
NY512		

Menu	Submenu/command	
Insert	Application Manager	---
	Safety Network Controller	NX
	Drive	---
	HMI	NA5
		NA
	Measurement Sensor	ZW
	Vision Sensor	FH
		FHV
	Slave Terminal	EtherNet/IP Coupler
		PROFINET Coupler
	Program	Ladder
		ST
		Section
	Function	Ladder
		ST
	Function Block	Ladder
		ST
	Axis Settings	Motion Control Axis
		Single-axis Position Control Axis
	Axes Group Settings	---
	CNC Settings	CNC Coord Settings
		CNC Motor Settings
		CNC Motor Compensation Table
NC Program		
Robot Control Setup	Robot Settings	
Cam Data Settings	---	
Data Trace		
DB Connection Settings		
Project	Check All Programs	---
	Check Selected Programs	
	Build Controller	
	Rebuild Controller	
	Abort Build	
	Memory Usage	
	Online Edit	Start
		Transfer
		Cancel
		Go to Edit Pane
	Library	Show References
Library Setting		
Create Library		

Menu	Submenu/command		
Controller	Communications Setup	---	
	Change Device		
	Online		
	Offline		
	Synchronization		
	Transfer	To Controller	
		From Controller	
	Mode	RUN Mode	
		PROGRAM Mode	
	Monitor	---	
	Stop Monitoring		
	Set/Reset	Set	
		Reset	
	Forced Refreshing	TRUE	
		FALSE	
		Cancel	
		Cancel All	
	MC Test Run	Start	
		Stop	
	MC Monitor Table	---	
	CNC Coordinate System Monitor Table	CNC Coordinate System (0)	
		CNC Coordinate System (1)	
		CNC Coordinate System (2)	
		CNC Coordinate System (3)	
		CNC Coordinate System (4)	
		CNC Coordinate System (5)	
CNC Coordinate System (6)			
CNC Coordinate System (7)			
Multiple Coordinate Systems			
SD Memory Card	---		
Controller Clock			
Release Access Right			
Update CPU Unit Name			
Firmware Update Log			

Menu	Submenu/command	
Controller	Security	Secure Communications Setting
		Set up user account
		Show user account list
		Change user account password
		Setting of Operation Authority
		ID for User Program Execution
		CPU Unit Write Protection
		Set/Release Data Protection
		Temporary Release of Change Prohibition
		Finish Temporary Release of Change Prohibition
		Temporary Release of Display/Change Prohibition
		Finish Temporary Release of Display/Change Prohibition
		Secure Socket Setting
Controller	Clear All Memory	---
	Reset Controller	---
Simulation	Run	---
	Run in PROGRAM mode	
	Pause	
	Stop	
	Step Execution	
	Step In	
	Step Out	
	Continuous Step Execution	
	Execute One Scan	
	Jump to Current Position	
	Breakpoint Window	
	Set/Clear Breakpoint	
	Enable/Disable Breakpoint	
	Clear All Breakpoints	
	Calibration	
	Run in Execution Time Estimation Mode	
	Transfer All Variable Present Values	
	Run with NA Simulator	
	Start NS Integrated Simulation	
	Safety Integrated Simulation	
	Use the OPC UA Server for the simulator	







Menu	Submenu/command		
Tools	Troubleshooting	---	
	Event Log Viewer	---	
	EtherCAT Diagnosis/Statistics Information Viewer	---	
	Backup	Backup Controller	
		Restore Controller	
		Compare with Backup File	
		Import Backup File	
		Export Backup File	
		Backup Variables and Memory	
		Restore Variables and Memory	
	Export Global Variables	Network Configurator	
		CX-Designer	
	Comments for Variables and Data Types	Import	
		Export	
	Export Program Hash Code	---	
	Import ST Program	---	
	IEC 61131-10 XML	Import	
	IEC 62714 AutomationML	Import	
	Import Motor sizing tool Results	---	
	SYSMAC Gateway	Export User Event Definition File	
	Update Configurations and Setup Transfer Data	---	
	EtherNet/IP Connection Settings	---	
	Launch External Application	CNC Operator	
	Automation Playback	Get Variable Log from Controller	
		Start Playback	
		Exit Playback	
		Playback Data Search Tab Page	
		Video Playback	
Playback Chart			
Customize Shortcut Keys	---		
Option	---		

Menu	Submenu/command	
Window	Close	---
	Float	
	Dock	
	New Horizontal Tab Group	
	New Vertical Tab Group	
	Move to Next Tab Group	
	Move to Previous Tab Group	
	Close All But This	
	Close All Except Active Device	
	Close All	
	Close Tab	
	Open Next Tab	
	Open Previous Tab	
Help	Help Contents	---
	Instruction Reference	
	System Defined Variable Reference	
	Keyboard Mapping Reference	
	Manual Download	
	Video Manual	
	Upgrading Information	
	Rating & Feedback	
	Online Registration	
About Sysmac Studio		

3-6 Basic Editing Operations

The following table lists the basic operations that you can perform in the Multiview Explorer and Edit Pane.

The operations that you can use depend on the item that you are editing.

Operation	Button	Menu command	Pop-up menu command	Mouse operation	Shortcut keys
Inserting	---	---	Insert	---	R or Shift + R
Cutting		Edit - Cut	Cut	Drag	Ctrl + X
Copying		Edit - Copy	Copy	Press Ctrl and drag.	Ctrl + C
Pasting		Edit - Paste	Paste	Drop	Ctrl + V
Deleting		Edit - Delete	Delete	---	Delete
Deleting to the left	---	---	---	---	BackSpace
Changing a name	---	---	Rename	---	---
Selecting rows	---	---	Select All	Enclose items.	Ctrl + ↑
Undoing		Edit - Undo	Undo	---	Ctrl + Z
Redoing		Edit - Redo	Redo	---	Ctrl + Y
Entering Edit Mode	---	---	Edit	Double-click	F2
Leaving Edit Mode	---	---	---	Click	Enter
Moving the cursor	---	---	---	---	↑, ↓, ←, or →
Moving the cursor to next or previous item	---	---	---	---	Tab or Shift + Tab
Moving the cursor to the beginning of the row	---	---	---	---	Home
Moving the cursor to the end of the row	---	---	---	---	End
Moving to the next page	---	---	---	---	PageDown
Moving to previous page	---	---	---	---	PageUp
Finding and replacing	---	---	---	---	Ctrl + F
Go To Rung	---	---	---	---	G
Display Rung Comment List	---	---	---	---	L

Note 1. The editing operation depends on the item/row.

Note 2. Refer to A-6 *Shortcut Keys* on page A-25 for other shortcut keys.

Pop-up Menus

Pop-up menus are provided to facilitate data editing in the panes.

Right-click the data item and select the command (e.g., **Add**, **Rename**, **Copy**, or **Paste**) from the pop-up menu.

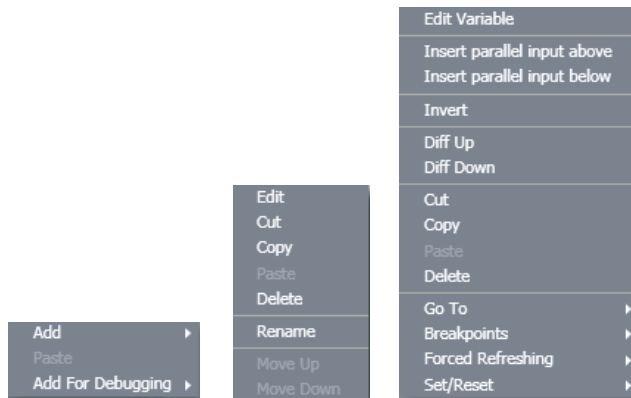

Entry Assistance

When you enter characters from the keyboard at the following times, the list of candidates that is displayed for selection is automatically narrowed.

● Entering Variable Names and Data Types

- Entering Variables Names in the Ladder Editor or ST Editor
- Entering Data Types in the Ladder Editor or ST Editor for Functions or Function Blocks
- Entering Data Types in Variable Tables

Example: When you enter a variable name in the Ladder Editor, click and press Ctrl + Space keys, or type the first character. Then the variable names that you can enter are displayed in a list.

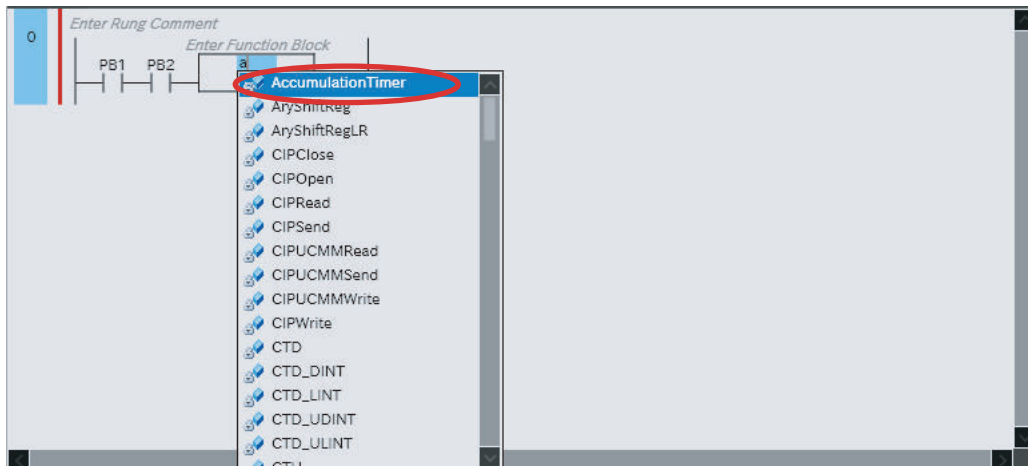

● Entering Text in the ST Editor

- When you enter text in the ST Editor or in an Inline ST Box, the cursor moves to the first item in the list that starts with the character that you entered.

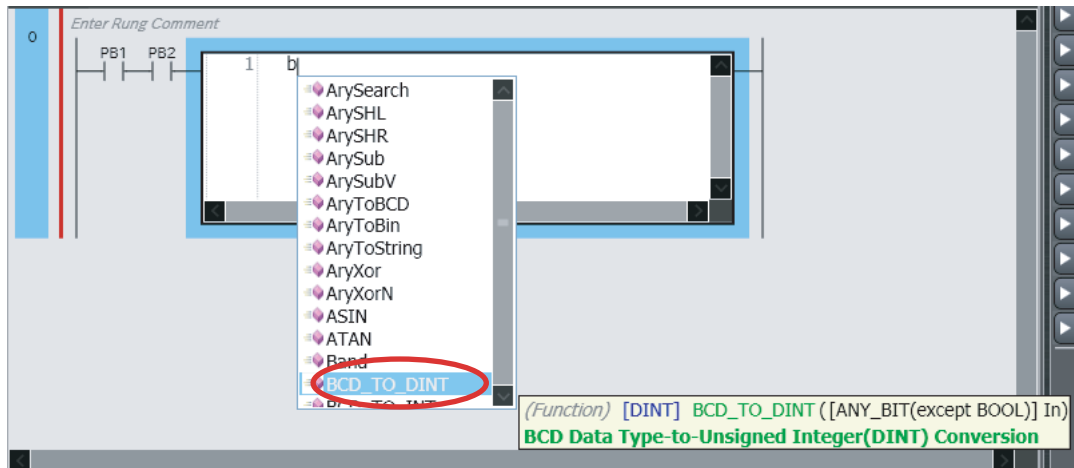

- When you press the Tab Key after entering the first keyword of a construct (“IF” in this example), the rest of the construct is automatically entered.

```

1 IF expression THEN
2     statement_group
3 ELSIF expression THEN
4     statement_group
5 ELSE
6     statement_group
7 END_IF;

```

- When you drag an ST statement (here, an IF statement) from the Structured Text Tools in the Toolbox of the ST Editor, the keywords for the construct for the ST statement are automatically entered.

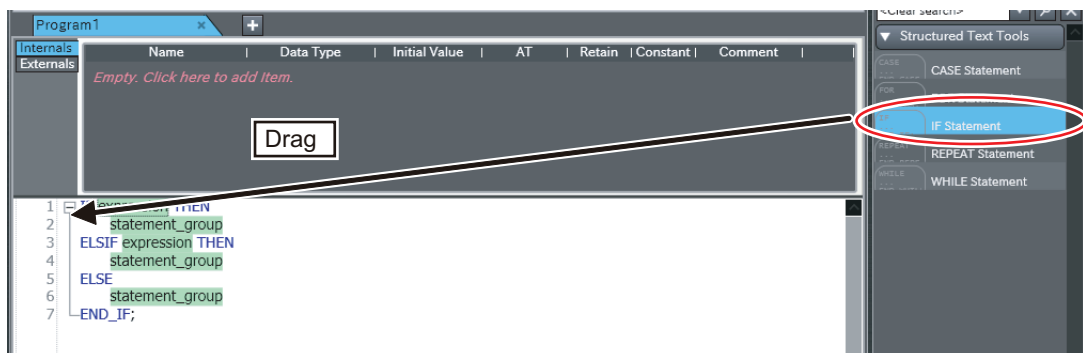

3-7 Sysmac Studio Settings and Operations

This section lists the operations of the Sysmac Studio.

3-7-1 Setting Parameters

Item	Description	Reference
EtherCAT Configuration and Setup	You create a configuration in the Sysmac Studio of the EtherCAT slaves that are connected to the built-in EtherCAT port on the NJ/NX-series CPU Unit or NY-series Industrial PC, and set the parameters in the master and slaves in that configuration.	5-2 EtherCAT Configuration and Setup on page 5-4
Registering slaves	You can set up devices by dragging slaves from the device list displayed in the Toolbox Pane to the locations where you want to connect them.	5-2-2 <i>Registering Slaves Offline to Configure EtherCAT</i> on page 5-4 5-2-3 <i>Registering Slaves Online to Configure EtherCAT</i> on page 5-6
Changing the Coupler model	You change the model number or unit version of a Coupler Unit. Use this function to change the model number and version of the Coupler Unit registered in the project to the new model number and version when replacing a Coupler Unit.	5-3-1 <i>Creating the EtherCAT Slave Terminal Configuration</i> on page 5-26
Changing the Servo Driver model	You can change the model number or the unit version of a Servo Driver registered in a project when replacing an actual Servo Driver.	Refer to the <i>Sysmac Studio Drive Functions Operation Manual (Cat. No. I589)</i> for details on the function.
Setting master parameters	You set the common parameters of the EtherCAT network (e.g., the fail-soft operation and wait time for slave startup settings).	5-2-4 <i>Setting Master Parameters</i> on page 5-8
Setting slave parameters	You set the standard slave parameters and assign PDOs (process data objects).	5-2-5 <i>Setting Slave Parameters</i> on page 5-9
Comparing and merging network configuration information	The EtherCAT network configuration information in the NJ/NX-series CPU Unit or NY-series Industrial PC and in the Sysmac Studio are compared and the differences are displayed.	5-2 EtherCAT Configuration and Setup on page 5-4
Transferring the network configuration information	The EtherCAT network configuration information is transferred to the NJ/NX-series CPU Unit or NY-series Industrial PC. Or, the EtherCAT network configuration information in the CPU Unit or PC is transferred to the Sysmac Studio and displayed in the EtherCAT Editor.	7-5-1 <i>Transferring/Comparing Data to/from the Controller</i> on page 7-127
Installing and uninstalling ESI files	ESI (EtherCAT slave information) files are installed and uninstalled.	5-2-7 <i>Installing and Uninstalling ESI Files</i> on page 5-17

Item	Description	Reference
EtherCAT Slave Terminal Configuration and Setup	The configuration of any Slave Terminal that is connected to an EtherCAT network is created on the Sysmac Studio. The NX Units that compose the Slave Terminal are set in the configuration.	5-3 EtherCAT Slave Terminal Configuration and Setup on page 5-25
Registering NX Units	A Slave Terminal is built by dragging NX Units from the device list displayed in the Toolbox to the locations where you want to mount them.	5-3-1 Creating the EtherCAT Slave Terminal Configuration on page 5-26
Setting NX Units	The I/O allocations, mounting settings, and Unit operation settings of the NX Units are edited.	5-3-1 Creating the EtherCAT Slave Terminal Configuration on page 5-26
Displaying the width of a Slave Terminal configuration	The width of the Slave Terminal configuration is displayed based on the Unit configuration information.	5-3-1 Creating the EtherCAT Slave Terminal Configuration on page 5-26
Comparing and merging the Slave Terminal configuration information	When online, you can compare the configuration information in the project with the physical configuration. You can also select the missing Units and add them to the project.	5-3-1 Creating the EtherCAT Slave Terminal Configuration on page 5-26
Transferring the Slave Terminal configuration information	The Unit configuration information is transferred to the NJ/NX-series CPU Unit or NY-series Industrial PC. The synchronize function is used.	5-3-1 Creating the EtherCAT Slave Terminal Configuration on page 5-26
CPU/Expansion Rack Configuration and Setup	In the Sysmac Studio, you create the configuration of the Units mounted in the CPU Rack and Expansion Racks of the following CPU Units: NJ-series, NX502, NX102, and NX1P2. Then you set the Special Unit, X Bus Unit, or NX Unit.	5-5 CPU/Expansion Rack Configuration and Setup on page 5-44
Registering Units	A Rack is built by dragging Units from the device list displayed in the Toolbox Pane to the locations where you want to mount them.	5-5-1 CPU/Expansion Racks for the NX502, NX102, or NX1P2 CPU Unit on page 5-44 5-5-2 CPU Rack and Expansion Racks for NJ-series CPU Units on page 5-55
Creating Racks	An Expansion Rack (Power Supply Unit, I/O Interface Unit, and End Cover) is added.	5-5-2 CPU Rack and Expansion Racks for NJ-series CPU Units on page 5-55

Item	Description	Reference
CPU/Expansion Rack Configuration and Setup	In the Sysmac Studio, you create the configuration of the Units mounted in the CPU Rack and Expansion Racks of the following CPU Units: NJ-series, NX502, NX102, and NX1P2. Then you set the Special Unit, X Bus Unit, or NX Unit.	5-5 CPU/Expansion Rack Configuration and Setup on page 5-44
Switching Unit displays	For NJ-series CPU Units, model numbers, unit numbers, and slot numbers are displayed. For NX502, NX102, and NX1P2 CPU Units, model numbers and unit numbers are displayed.	5-5-1 CPU/Expansion Racks for the NX502, NX102, or NX1P2 CPU Unit on page 5-44 5-5-2 CPU Rack and Expansion Racks for NJ-series CPU Units on page 5-55
Setting Special Units	The input time constants are set for Input Units and parameters are set for Special Units.	5-5-2 CPU Rack and Expansion Racks for NJ-series CPU Units on page 5-55
Displaying Rack widths, current consumption, and power consumption	For NJ-series CPU Units, a rack width, current consumption, and power consumption are displayed based on the Unit configuration information. For NX502, NX102, and NX1P2 CPU Units, a rack width is displayed based on the Unit configuration information.	5-5-2 CPU Rack and Expansion Racks for NJ-series CPU Units on page 5-55
Comparing the CPU/Expansion Rack configuration information with the physical configuration	When online, you can compare the configuration information in the project with the physical configuration. You can also select the missing Units and add them.	5-5-1 CPU/Expansion Racks for the NX502, NX102, or NX1P2 CPU Unit on page 5-44 5-5-2 CPU Rack and Expansion Racks for NJ-series CPU Units on page 5-55
Transferring the CPU/Expansion Rack configuration information	The Unit configuration information is transferred. The synchronize function is used.	5-5-1 CPU/Expansion Racks for the NX502, NX102, or NX1P2 CPU Unit on page 5-44 7-5-1 Transferring/Comparing Data to/from the Controller on page 7-127
Printing the Unit configuration information	The Unit configuration information is printed.	8-5 Printing on page 8-52

Item	Description	Reference
Controller Setup	The Controller Setup is used to change settings related to the operation of the Controller. The Controller Setup contains PLC Function Module operation settings and built-in EtherNet/IP Function Module port settings.	5-6 <i>Controller Setup</i> on page 5-65
Operation Settings	The Startup Mode, SD Memory Card Diagnosis at Startup, Write Protection at Startup, Controller Error Level Changes, and other settings are made.	5-6-1 <i>Operation Settings</i> on page 5-65
Transferring Operation Settings	The synchronization function is used to transfer the operation settings to the NJ/NX-series CPU Unit or NY-series Industrial PC.	5-6-1 <i>Operation Settings</i> on page 5-65
Built-in EtherNet/IP Port Settings	These settings are made to perform communications using the built-in EtherNet/IP port on the NJ/NX-series CPU Unit or NY-series Industrial PC.	5-6-2 <i>Built-in EtherNet/IP Port Settings</i> on page 5-71
Transferring Built-in EtherNet/IP Port Settings	The synchronization function is used to transfer the built-in EtherNet/IP port settings to the NJ/NX-series CPU Unit or NY-series Industrial PC.	5-6-2 <i>Built-in EtherNet/IP Port Settings</i> on page 5-71
Built-in I/O Settings	You make the settings related to built-in I/O of the NX1P2 CPU Unit.	5-6-3 <i>Built-in I/O Settings</i> on page 5-77
Transferring Built-in I/O Settings	The synchronization function is used to transfer the built-in I/O settings to the NX1P2 CPU Unit.	5-6-3 <i>Built-in I/O Settings</i> on page 5-77
Option Board Settings	You make the settings related to the option boards mounted on the NX1P2 CPU Unit.	5-6-4 <i>Option Board Settings</i> on page 5-77
Transferring Option Board Settings	The synchronization function is used to transfer the option board settings to the NX1P2 CPU Unit.	5-6-4 <i>Option Board Settings</i> on page 5-77
Memory Settings	You make the settings related to the memory area for CJ-series Units in the NX502, NX102, NX1P2 and NX701-1□20 CPU Units.	5-6-5 <i>Memory Settings</i> on page 5-78
Transferring Memory Settings	The synchronization function is used to transfer the memory settings to the CPU Unit.	5-6-5 <i>Memory Settings</i> on page 5-78
Motion Control Setup	The Motion Control Setup is used to create the axes to use in motion control instructions, assign those axes to Servo Drives and encoders, and set axis parameters.	5-7 <i>Motion Control Setup</i> on page 5-80
Axis Settings	Axes are added to the project.	5-7-1 <i>Setting Axes</i> on page 5-80
Importing Axis Settings	You can add or update new axis settings by importing an XML file.	5-7-2 <i>Exporting and Importing Axis Settings</i> on page 5-88
Exporting Axis Settings	You can export multiple axis settings in a project all together to an XML file.	5-7-2 <i>Exporting and Importing Axis Settings</i> on page 5-88
Deleting Multiple Axis Settings	You can delete selected axis settings in a project at once.	5-7-3 <i>Deleting Multiple Axis Settings</i> on page 5-96
Axis Setting Table	The Axis Setting Table is a table of all registered axis parameters. You can edit any axis parameters here just as you can on the Axis Settings Tab Page.	5-7-1 <i>Setting Axes</i> on page 5-80

Item	Description	Reference
Axes Group Settings	You can set up axes to perform interpolated motions as an axes group.	5-7-4 <i>Setting Axes Groups</i> on page 5-97
Axes Group Basic Settings	Set the axes group number, whether to use the axes group, the composition, and the composition axes.	5-7-4 <i>Setting Axes Groups</i> on page 5-97
Operation Settings	Set the interpolated velocity, the maximum interpolated acceleration and deceleration, and the interpolated operation settings.	5-7-4 <i>Setting Axes Groups</i> on page 5-97
Importing	By importing an XML file, it is possible to add or update new axes group settings.	5-7-5 <i>Exporting and Importing Axes Group Settings</i> on page 5-99
Exporting	You can export multiple axes group settings in a project all together to an XML file.	5-7-5 <i>Exporting and Importing Axes Group Settings</i> on page 5-99
Deleting Multiple Items	You can delete all selected axes group settings in a project at once.	5-7-6 <i>Deleting Multiple Axes Group Settings</i> on page 5-103
Cam Data Settings	The cam data settings are used to create electronic cam data. When you build the project for the Controller, a cam table is created according to the cam data settings.	5-8 <i>Cam Data Settings</i> on page 5-105
Registering cam data settings	Cam data settings are added to the project.	5-8 <i>Cam Data Settings</i> on page 5-105
Editing cam data settings	You can set properties and node points for cam data settings.	5-8 <i>Cam Data Settings</i> on page 5-105
Transferring cam data settings	You can select to transfer all or part of the cam data.	5-8 <i>Cam Data Settings</i> on page 5-105
Importing cam data settings	You can import cam data settings from a CSV file.	5-8 <i>Cam Data Settings</i> on page 5-105
Exporting cam data settings	You can export cam data to a CSV file.	5-8 <i>Cam Data Settings</i> on page 5-105
Registering cam definitions	You add new cam definitions to change a cam table in the program.	5-8-10 <i>Registering Cam Definitions</i> on page 5-117
Editing cam definitions	You set cam definitions.	5-8-10 <i>Registering Cam Definitions</i> on page 5-117
Transferring cam definitions	You transfer cam definitions to the Controller.	5-8-11 <i>Transferring Cam Definitions</i> on page 5-121
Exporting cam tables	You can export a cam table to a CSV file.	5-8 <i>Cam Data Settings</i> on page 5-105
Transferring cam tables from the Controller to files	You can save a cam table in the NJ/NX-series CPU Unit or NY-series Industrial PC to a CSV file.	5-8 <i>Cam Data Settings</i> on page 5-105
Transferring cam tables from files to the Controller	You can transfer a cam table that is saved in a CSV file to update the contents of a cam table that is already in the NJ/NX-series CPU Unit or NY-series Industrial PC.	5-8 <i>Cam Data Settings</i> on page 5-105
Superimposing Cam Data	You can superimpose the cam table from a CSV file on the cam profile curve position graph that is currently displayed.	5-8 <i>Cam Data Settings</i> on page 5-105

Item	Description	Reference
Task Settings	Programs are executed in tasks in an NJ/NX-series CPU Unit or NY-series Industrial PC. The task settings define the execution period, the execution timing, the programs executed by the task, the I/O refreshing performed by the task, and which variables to share between tasks.	5-9 <i>Task Settings</i> on page 5-125
Registering tasks	The tasks, which are used to execute programs, are registered.	5-9-1 <i>Registering Tasks</i> on page 5-125
Setting task I/O	The task I/O settings define what Units the task should perform I/O refreshing for.	5-9-3 <i>Task I/O Settings</i> on page 5-126
Assigning programs	Program assignments define what programs a task will execute.	5-9-4 <i>Program Assignments</i> on page 5-127
Setting exclusive control of variables in tasks	You can specify if a task can write to its own values (known as a refreshing task) or if it can only access them (an accessing task) for global variables. This ensures concurrency for global variable values from all tasks that reference them.	5-9-5 <i>Settings for Exclusive Control of Variables in Tasks</i> on page 5-128
I/O Map Settings	The I/O ports that correspond to the registered EtherCAT slaves and to the registered Units on the CPU Rack and Expansion Racks are displayed. The I/O Map is edited to assign variables to I/O ports. The variables are used in the user program.	4-1 <i>Variable Registration</i> on page 4-3
Displaying I/O ports	I/O ports are displayed based on the configuration information of the devices (slaves and Units).	4-1 <i>Variable Registration</i> on page 4-3
Assigning variables	Variables are assigned to I/O ports.	4-1 <i>Variable Registration</i> on page 4-3
Creating device variables	Device variables are created in the I/O Map. You can either automatically create a device variable or manually enter the device variable to create.	4-1 <i>Variable Registration</i> on page 4-3
Checking I/O assignments	The assignments of external I/O devices and variables are checked.	7-5-4 <i>Checking I/O Assignments</i> on page 7-154
Setting Vision Sensors	Vision Sensor settings and calibration are set.	3-7-22 <i>Vision Sensor Functions</i> on page 3-96
Displacement Sensor Settings	Displacement Sensor settings and calibration are set.	3-7-23 <i>Displacement Sensor Functions</i> on page 3-103
DB Connection Function Settings	You can set and transfer the DB connection function settings.	3-7-15 <i>Function Specifications of DB Connection Function</i> on page 3-82
EtherNet/IP Connection Settings	You can make settings related to tag data links (connections) in an EtherNet/IP network.	3-7-17 <i>EtherNet/IP Connection Settings</i> on page 3-83
EtherNet/IP Slave Terminal Settings	You can make and transfer settings for EtherNet/IP Slave Terminals.	3-7-18 <i>EtherNet/IP Slave Terminal Settings</i> on page 3-83
NA-series Programmable Terminal (PT) Settings	You can make settings and transfer projects for NA-series Programmable Terminals.	3-7-21 <i>Function Specifications of NA-series Programmable Terminals</i> on page 3-90

3-7-2 Programming

Item	Description	Page
Instruction list (Toolbox)	A hierarchy of the instructions that you can use is displayed in the Toolbox. You can drag the required instruction to a program in the Ladder Editor or ST Editor to insert the instruction.	3-4-4 <i>Toolbox (4)</i> on page 3-41
Programming ladder diagrams	Ladder diagram programming involves connecting circuit parts with connecting lines to build algorithms. Circuit parts and connecting lines are entered in the Ladder Editor.	4-5 <i>Programming Ladder Diagrams</i> on page 4-85
Starting the Ladder Editor	The Ladder Editor for the program is started.	4-5-1 <i>Opening and Using the Ladder Editor</i> on page 4-85
Showing the Ladder Editor Guide	Sysmac Studio displays the operation guide on the Ladder Editor for editing programs. You can arrange circuit parts, re-connect lines, and add lines following the guide.	4-5-9 <i>Ladder Editor Guide</i> on page 4-142
Displaying the shortcut key list	This function shows a list of shortcut keys for editing ladder diagrams.	4-5-10 <i>Ladder Editor Shortcut Key List</i> on page 4-145
Adding and deleting sections	You can divide your ladder diagrams into smaller units for easier management. These units of division are called <i>sections</i> .	4-5-2 <i>Adding and Deleting Sections</i> on page 4-86
Inserting circuit parts	You insert circuit parts in the Ladder Editor to create an algorithm.	<i>Inserting Program Inputs and Outputs</i> on page 4-91
Inserting and deleting function blocks	You can insert a function block instruction or user-defined function block into the Ladder Editor.	<i>Inserting Function Block Instructions and User-defined Function Blocks</i> on page 4-117 <i>Deleting Function Block Instructions and User-defined Function Blocks</i> on page 4-123
Inserting and deleting functions	You can insert a function instruction or user-defined function into the Ladder Editor.	<i>Inserting Function Instructions and User-defined Functions</i> on page 4-120 <i>Deleting Function Instructions and User-defined Functions</i> on page 4-123
Inserting and deleting inline ST	You can insert a circuit part in a ladder diagram to enable programming in ST. This allows you to include ST in a ladder diagram.	<i>Inserting and Deleting Inline ST</i> on page 4-105
Editing circuit parts	You can copy and paste circuit parts.	<i>Copying and Pasting Circuit Parts</i> on page 4-108
Inserting and deleting jump labels and jumps	You can insert a jump label in the rung to jump to and then specify that jump label when you insert a jump.	4-5-7 <i>Inserting and Deleting Jump Labels and Jumps</i> on page 4-138

Item	Description	Page
Programming ladder diagrams	Ladder diagram programming involves connecting circuit parts with connecting lines to build algorithms. Circuit parts and connecting lines are entered in the Ladder Editor.	<i>4-5 Programming Ladder Diagrams</i> on page 4-85
Inserting and deleting bookmarks	You can add bookmarks to the beginning of rungs and move between them.	<i>Inserting and Deleting Bookmarks</i> on page 4-111
Rung comments	You can add comments to rungs.	<i>Entering Rung Comments</i> on page 4-136
Displaying rung errors	When you enter a circuit part, the format is always checked and any mistakes are displayed as errors. If there are any errors, a red line is displayed between the rung number and the left bus bar.	<i>Displaying Rung Errors</i> on page 4-112
Entry assistance	When you enter instructions or parameters, each character that you enter from the keyboard narrows the list of candidates that is displayed for selection.	<i>3-6 Basic Editing Operations</i> on page 3-59
Displaying variables with comments	You can display variable comments along with the variables in the circuit parts of a ladder program. You can change the length of the displayed variable comments to make them easier to read.	<i>8-26 Sysmac Studio Option Settings</i> on page 8-166
Element comment	You can add an element comment on the ladder circuit parts.	<i>Entering Element Comments</i> on page 4-135
Rung comment list	Displays a list of rung comments for a ladder program. Double-click a comment in the list to go to the related rung.	<i>Displaying Rung Comment List</i> on page 4-136
Rung pattern copy	You can duplicate a rung pattern (logic part). Variable names in a copied rung can be set automatically according to the variable name generation rules.	<i>4-5-11 Rung Pattern Copy</i> on page 4-146

Item	Description	Page
Programming structured text	You combine different ST statements to build algorithms.	4-6 <i>Programming Structured Text</i> on page 4-152
Starting the ST Editor	The ST Editor for programs or for functions/function blocks is started.	4-6-1 <i>Starting the ST Editor</i> on page 4-152
Editing ST	You combine different ST statements to build algorithms.	4-6-2 <i>Basic ST Editor Operations</i> on page 4-153
Entering calls to functions and function blocks	You can enter the first character of the instance name of the function or the function block in the ST Editor to call and enter a function or function block.	4-6-4 <i>Operating Functions and Function Blocks in the ST Editor</i> on page 4-162
Entering constants	You can enter constants in the ST Editor.	<i>Entering Constants</i> on page 4-155
Entering comments	Enter (* at the beginning and *) at the end of any text to be treated as a comment in the ST Editor. If you only want to comment out a single line, enter a double forward slash // at the beginning of the line.	<i>Entering Comments</i> on page 4-156
Copying, pasting, and deleting ST elements	You can copy, paste, and delete text strings.	<i>Copying and Pasting ST Elements</i> on page 4-156 <i>Deleting ST Elements</i> on page 4-156
Indenting	You can indent nested statements to make them easier to read.	<i>Indenting</i> on page 4-157
Moving to a specified line	You can specify a line number to jump directly to that line.	<i>Moving to a Specified Line</i> on page 4-157
Bookmarks	You can add bookmarks to any lines and move between them.	<i>Bookmarks</i> on page 4-157
Entry assistance	When you enter instructions or parameters, each character that you enter from the keyboard narrows the list of candidates that is displayed for selection.	3-6 <i>Basic Editing Operations</i> on page 3-59
Namespaces	Namespaces allow you to group and nest the names of functions, function block definitions, and data types so that you can manage them. This reduces the chance of duplicated names and makes the entities easier to access.	4-4 <i>Namespaces</i> on page 4-79
Variable Manager	A list of the variables in the global and local variable tables is displayed in a separate window. You can display variable usage, sort and filter the variables, edit and delete variables, or move variables while displaying another editing view.	4-1 <i>Variable Registration</i> on page 4-3
Changing variable comments and data type comments	You can globally change variable comments and data type comments to other comments. You can change the comments to different language for users in a different country.	8-17 <i>Changing Variable Comments and Data Type Comments</i> on page 8-140
Exporting/importing variable comments	You can export/import variable comments, comments of structure members and union members, and variable element comments of array variables to an Office Open XML file (xlsx file).	4-1-9 <i>Entering Variable Attributes</i> on page 4-36

Item		Description	Page
Sorting and filtering variables		You can sort and filter the variables in each variable table.	4-1-1 <i>Creating Global Variables</i> on page 4-4 4-1-3 <i>Creating Local Variables</i> on page 4-22
Searching and replacing		You can search for and replace strings in the data of a project.	4-8 <i>Searching and Replacing</i> on page 4-168
Retrace search		You can search for and jump to program inputs and input parameters that use the variable assigned to a program output or the output parameter of a function or function block. You can also search for and jump to program outputs and output parameters that use the variable assigned to a program input or the input parameter of a function or function block.	<i>Searching for and Jumping to Variables in Ladder POUs</i> on page 4-114
Jumping		You can jump to the specified rung number or line number in the program.	4-5-7 <i>Inserting and Deleting Jump Labels and Jumps</i> on page 4-138
Build- ing	Building	The programs in the project are converted into a format that is executable in the NJ/NX-series CPU Unit or NY-series Industrial PC.	4-10 <i>Building and Rebuilding</i> on page 4-178
	Rebuilding	A rebuild is used to build project programs that have already been built.	4-10 <i>Building and Rebuilding</i> on page 4-178
	Aborting a build operation	You can abort a build operation.	4-10 <i>Building and Rebuilding</i> on page 4-178
Creating applications for NA-series PTs		You can create and transfer pages and subroutines for NA-series Programmable Terminals.	Refer to 3-7-21 <i>Function Specifications of NA-series Programmable Terminals</i> on page 3-90

3-7-3 Library Functions

Item		Description	Page
Libraries		You can create programs, functions, function block definitions, and data types in a library file to reuse them as objects in other projects.	9-3 <i>Creating and Using Libraries</i> on page 9-8
	Creating libraries	You can create library files to enable using programs, functions, function block definitions, and data types in other projects.	9-3-1 <i>Creating a Library</i> on page 9-8
	Using libraries	You can access and use objects from library files that were created in other projects.	9-3-2 <i>Using a Library</i> on page 9-12

3-7-4 Project Management

	Item	Description	Page
File operations	Creating a project file	A project file is created.	3-3-2 <i>Creating a Project File</i> on page 3-11
	Opening a project file	A project file is opened.	3-3-6 <i>Opening a Project File</i> on page 3-18
	Saving the project file	The project file is saved.	3-3-4 <i>Saving the Project File</i> on page 3-17
	Saving a project file under a different name	A project file is saved under a different name.	3-3-5 <i>Saving a Project File Under a Different Name</i> on page 3-17
	Project update history management	You can assign numbers to projects to manage the project history.	3-3-10 <i>Project Update History Management</i> on page 3-25
	Exporting a project file	You can export a project to an .smc2 or .csm2 project file (version 1.08 or higher). You can also export a project to a previous project file format, i.e., .smc or .csm.	3-3-7 <i>Exporting a Project File</i> on page 3-19
	Importing a project file	You can import a project from an .smc2 (version 1.08 or higher), .csm2 (version 1.08 or higher), .smc, or .csm project file.	3-3-8 <i>Importing a Project File</i> on page 3-21
	Importing ST programs	You can import ST program files that were created with the Simulink® PLC Coder™ version R2013a or higher from MathWorks® Inc.	8-20 <i>Importing ST Programs</i> on page 8-149
	IEC 61131-10 XML	You can import program/function/function block POUs of the IEC 61131-10 XML format, global variables and data types.	8-21 <i>Importing IEC 61131-10 XML Files</i> on page 8-151
	IEC 62714 AutomationML	You can create a controller configuration or device variable through importing an AutomationML file which is created with EPLAN Electric P8, an electric CAD software.	8-22 <i>Importing IEC-62714 AutomationML Files</i> on page 8-155
	Offline comparison	You can compare the data for an open project with the data for a project file and display the results. You can also compare the open project with an exported .smc2 (version 1.08 or higher) or .smc project file. Or, you can merge detailed comparison results. You can print out the differences between compared ladder programs.	4-11 <i>Offline Comparison</i> on page 4-180
	Importing motor sizing tool results	You can import the EtherCAT configuration and motion control settings created by the motor sizing tool.	8-23 <i>Importing Motor Sizing Tool Results</i> on page 8-162
Cutting, copying, and pasting		You can cut, copy, or paste items that are selected in the Multi-view Explorer or any of the editors.	3-6 <i>Basic Editing Operations</i> on page 3-59
Printing		You can print various data. You can select the items to print.	8-5 <i>Printing</i> on page 8-52

Item	Description	Page
Data sharing	Creating a derivative device.	9-4 <i>Program Sharing in Derived Devices</i> on page 9-17
	Setting a shared program between devices	9-4 <i>Program Sharing in Derived Devices</i> on page 9-17

3-7-5 Debugging

Item	Description	Page
Monitoring	Variables are monitored during ladder program execution. You can monitor the TRUE/FALSE status of inputs and outputs and the present values of variables in the NJ/NX-series CPU Unit or NY-series Industrial PC. You can monitor operation on the Ladder Editor, ST Editor, Watch Tab Page, or I/O Map.	7-2-1 <i>Monitoring</i> on page 7-4
Differential monitoring	You can detect the number of times the specified BOOL variable or BOOL member changes to TRUE or FALSE and display the count in the Differential Monitor Dialog Box. You can check if bits turn ON and OFF and the number of times that they turn ON and OFF.	7-2-2 <i>Differential Monitor</i> on page 7-21
Changing present values and TRUE/FALSE	You can change the values of variables that are used in the user program and settings to any desired value, and you can change program inputs and outputs to TRUE or FALSE. This allows you to check the operation of the user program and settings.	7-2-3 <i>Changing Present Values and Set/Reset Using Forced Refreshing</i> on page 7-24
Changing the present values of variables	You can change the present values of user-defined variables, system-defined variables, and device variables as required. You can do this in the Ladder Editor, ST Editor, Watch Tab Page, or I/O Map.	7-2-3 <i>Changing Present Values and Set/Reset Using Forced Refreshing</i> on page 7-24
Forced refreshing	Forced refreshing allows the user to refresh external inputs and outputs with user-specified values from the Sysmac Studio. The specified value is retained even if the value of the variable is overwritten from the user program. You can use forced refreshing to force BOOL variables to TRUE or FALSE in the Ladder Editor, Watch Tab Page, or I/O Map.	7-2-3 <i>Changing Present Values and Set/Reset Using Forced Refreshing</i> on page 7-24
Online editing	Online editing allows you to edit programs on systems that are currently in operation. Online editing can be used to edit only POU's and global variables. User-defined data types cannot be edited with online editing.	7-2-5 <i>Online Editing</i> on page 7-41
Cross Reference Tab Page	Cross references allow you to see the programs and locations where program elements (variables, data types, I/O ports, functions, or function blocks) are used. You can view all locations where an element is used from this list.	7-2-4 <i>Cross References</i> on page 7-36

Item	Description	Page
Data tracing	<p>Data tracing allows you to sample the specified variables and store the values of the variables in trace memory without any programming.</p> <p>You can choose between two trace methods: a triggered trace, where you set a trigger condition and data is saved before and after that condition is met, or a continuous trace, in which continuous sampling is performed without any trigger and the results are stored in a file on your computer.</p> <p>However, you can still display data retrieved on the Sysmac Studio and save those results to a file even if you use a triggered trace. These same functions can be used with the Simulator as well.</p>	7-2-11 <i>Data Tracing</i> on page 7-53
Setting sampling intervals	The interval to perform sampling on the target data is set. Sampling is performed for the specified task period, at the specified time, or when a trace sampling instruction is executed.	7-2-11 <i>Data Tracing</i> on page 7-53
Setting triggers	To perform a triggered trace, you set a condition to trigger sampling. A suitable trigger condition is set to record data before and after an event.	7-2-11 <i>Data Tracing</i> on page 7-53
Setting a continuous trace	The method to save the data traced during a continuous trace is set.	7-2-11 <i>Data Tracing</i> on page 7-53
Setting variables to sample	The variables to store in trace memory are registered. The sampling intervals can also be set.	7-2-11 <i>Data Tracing</i> on page 7-53
Starting and stopping tracing	The data trace settings are transferred to the NJ/NX-series CPU Unit or NY-series Industrial PC and the tracing starts. If you selected <i>Single</i> as the trace type, tracing waits for the trigger to begin sampling. If you selected <i>Continuous</i> , sampling begins immediately and all traced data is transferred to the computer as it is gathered and saved to a file.	7-2-11 <i>Data Tracing</i> on page 7-53
Displaying trace results	<p>You view the results of the traced data in either a chart or in the 3D Motion Monitor.</p> <p>After sampling begins, sample data is immediately transferred and drawn on the graph.</p> <p>The trace target variable table shows the maximum, minimum, and average values for each variable.</p> <p>You can also change the colors of the lines on the graph.</p>	7-2-11 <i>Data Tracing</i> on page 7-53
Exporting/importing trace results	<p>Trace results are saved within your project automatically when you save the project on the Sysmac Studio.</p> <p>If you want to save this data as a separate file, you can export the data to save it in a CSV file. You can import trace results that you have exported.</p>	7-2-11 <i>Data Tracing</i> on page 7-53
Printing trace results	You can print out data trace settings along with digital and analog charts.	7-2-11 <i>Data Tracing</i> on page 7-53
Debugging a Vision Sensor	You can debug the Vision Sensor offline.	3-7-22 <i>Vision Sensor Functions</i> on page 3-96
Debugging a Displacement Sensor	You can debug the Displacement Sensor offline.	3-7-23 <i>Displacement Sensor Functions</i> on page 3-103
Output Factor Search	It is a function that searches for the rungs that causes an output among the elements of a ladder program in the Controller, and displays them in a tree structure.	7-2-12 <i>Output Factor Search</i> on page 7-80

3-7-6 Simulation

Item	Description	Page	
Programs for debugging	You can create programs for debugging that are used only to execute simulations and specify virtual inputs for simulation.	7-3-1 <i>Debugging with Program Simulation</i> on page 7-86	
Executing a simulation	Selecting what to simulate	You can select the programs to simulate from all of the programs in the Sysmac Studio. Programs can be dragged to select them.	7-3-1 <i>Debugging with Program Simulation</i> on page 7-86
	Setting breakpoints	You can set breakpoints to stop the simulation in the Program Editor.	7-3-1 <i>Debugging with Program Simulation</i> on page 7-86
	Executing and stopping simulations	You can control simulation execution to monitor the user program or to check operation through data tracing. Step execution and pausing are also possible.	7-3-1 <i>Debugging with Program Simulation</i> on page 7-86
		You can perform a linked simulation between sequence control and continuous control (operations controlled by Simulink) to debug the sequence control program and continuous control program. MATLAB/® R2013a or higher is required.	---
	Changing the simulation speed	You can change the execution speed.	7-3-1 <i>Debugging with Program Simulation</i> on page 7-86
	Task period simulation	You can display the task periods.	7-3-1 <i>Debugging with Program Simulation</i> on page 7-86
	Batch transfer of the present values of variables	You can save the values of variables at specific times during simulations in a file, or you can write the values of variables that were saved in a file back to the Simulator. This allows you to write the initial values of variables, e.g., for test applications, before you start a simulation.	7-3-1 <i>Debugging with Program Simulation</i> on page 7-86
	Integrated NS-series PT simulation	You can simulate the linked operation of a sequence program and an NS-series Programmable Terminal to debug the sequence program and screen data offline.	7-3-6 <i>Integrated NS-series PT Simulation for Offline Debugging of Sequence Control and NS-series PTs</i> on page 7-118
	Simultaneous simulation of Controller and NA-series PT	You can simultaneously simulate sequence control and NA-series PT operation, including displaying pages and subroutines created with Visual Basic and debugging the sequence programming.	7-3-5 <i>Offline Debugging with Sequence Control and NA-series PT Simulator (Simultaneous Simulation of Controller with NA-series PT)</i> on page 7-115
Safety Integrated Simulation	You can simulate the linked operation of a sequence program and Safety CPU Unit to debug the sequence program and safety program offline.	7-3-7 <i>Offline Debugging for Sequence Control and Safety CPU Units</i> on page 7-120	
OPC UA Server Functions	By executing an OPC UA Server function on Simulator, the OPC UA Client can read and write variables during simulation.	7-3-9 <i>Executing OPC UA Server on the Simulator</i> on page 7-121	

Item		Description	Page
Setting the virtual equipment	Creating 3D equipment models*1	You can create a 3D equipment model at the control target to monitor with 3D motion monitoring.	7-2-11 <i>Data Tracing</i> on page 7-53
	3D Motion Monitor Display Mode*1	You set the axis variables for each element of the 3D equipment model, and then set the 3D equipment into motion according to those axis motions.	7-2-11 <i>Data Tracing</i> on page 7-53
	Displaying 2D paths*1	You can display the 2D paths of the markers for the projections in the 3D display.	7-2-11 <i>Data Tracing</i> on page 7-53

*1. Not supported by the Sysmac Studio (64 bit).

3-7-7 Monitoring Information

Item		Description	Page
Displaying unit production information		You can display the production information of the NJ/NX-series CPU Unit, NY-series Industrial PC, and Special Units, including the models of the Units and unit versions.	8-8-1 <i>Displaying CPU Unit Production Information</i> on page 8-65
Monitoring task execution times		You can monitor the execution time of each task when the user program is executed on an NJ/NX-series CPU Unit, NY-series Industrial PC, or in the Simulator. When the Simulator is connected, you can also monitor the real processing time of tasks. This allows you to perform a Controller performance test.	7-2-9 <i>Task Execution Time Monitor</i> on page 7-50
Troubleshooting		You can use troubleshooting to check the errors that occurred in the Controller, display corrections for the errors, and clear the errors.	8-16 <i>Troubleshooting</i> on page 8-120
Controller errors		Any current Controller errors are displayed. (Observations and information are not displayed.)	8-16-2 <i>Controller Errors</i> on page 8-121
User-defined errors		Information is displayed on current errors.	8-16-4 <i>User-defined Errors</i> on page 8-129
Controller event log		You can display a log of Controller events (including Controller errors and Controller information). (You cannot display logs from EtherCAT slaves.)	8-16-3 <i>Controller Event Log</i> on page 8-125
User-defined event log		The log of user-defined events that were stored for the Create User-defined Error (SetAlarm) instruction and the Create User-defined Information (SetInfo) instruction is displayed.	8-16-5 <i>User-defined Event Log</i> on page 8-130
Event Settings Table		The Event Setting Table is used to register the contents displayed on the Sysmac Studio and on HMIs for user-defined events that occur for execution of the Create User-defined Error (SetAlarm) instruction and the Create User-defined Information (SetInfo) instruction.	8-16-6 <i>Event Setting Table</i> on page 8-131
User memory usage monitor		An estimate of the space that is used by the user program that you are editing in the Sysmac Studio is displayed in relation to the size of the NJ/NX-series CPU Unit or NY-series Industrial PC's memory.	8-4 <i>User Memory Usage Monitor</i> on page 8-49
Setting clock information		You can read and set the NJ/NX-series CPU Unit or NY-series Industrial PC's clock. The computer's clock information is also displayed.	8-2 <i>Clock Information Settings</i> on page 8-8
DB connection function		You can monitor information for the database connection.	3-7-15 <i>Function Specifications of DB Connection Function</i> on page 3-82

Item	Description	Page
Going online with a Controller	An online connection is established with the Controller. You also can transfer a project from the connected Controller to the computer with a simple operation without creating a new project or opening an existing project.	6-2 <i>Going Online with a Controller</i> on page 6-3
Checking for forced refreshing	When you go offline, any forced refreshing is cleared.	6-2-7 <i>Checking for Forced Refreshing</i> on page 6-9
Synchronize	The data (project file) in the computer is compared with the data in the NJ/NX-series CPU Unit and NY-series Industrial PC that are connected online, the difference is displayed in a list, and batch transfer can be performed for the individually-specified data.	7-5-1 <i>Transferring/ Comparing Data to/ from the Controller</i> on page 7-127
Batch transfer	You transfer data between the computer and NJ/NX-series CPU Unit or NY-series Industrial PC that are connected online. You can select the same data to transfer as in the synchronization operation. Unlike the synchronization operation, the data is transferred in the specified direction without displaying the comparison results.	8-11 <i>Transferring All Controller Data</i> on page 8-88

3-7-9 Maintenance

Item	Description	Page
Changing the operating mode of the Controller	There are two operating modes for NJ/NX/NY-series Controllers, depending on if control programs are executed or not. These are RUN mode and PROGRAM mode.	7-2-6 <i>Changing the Operating Mode</i> on page 7-45
Resetting the Controller	The operations and status when the power supply to the Controller is cycled are emulated. This can be performed only in PROGRAM mode. You cannot reset the Controller in RUN mode.	7-5-5 <i>Resetting the Controller</i> on page 7-155
Clear All Memory	The Clear All Memory Menu command is used to initialize the user program, Controller Configurations and Setup, and variables in the CPU Unit to the defaults from the Sysmac Studio.	8-6 <i>Clearing Memory</i> on page 8-58
SD Memory Cards	The following procedures are used to execute file operations for the SD Memory Card mounted in the NJ/NX-series CPU Unit or the Virtual SD Memory Card of the NY-series Industrial PC (hereafter called SD Memory Card), and to copy files between the SD Memory Card and computer.	8-1 <i>SD Memory Card Operations</i> on page 8-4
Formatting the SD Memory Card	The SD Memory Card is formatted.	8-1 <i>SD Memory Card Operations</i> on page 8-4
Displaying properties	The properties of the selected file or folder in the SD Memory Card are displayed.	8-1 <i>SD Memory Card Operations</i> on page 8-4
Copying files and folders in the SD Memory Card	The selected file or folder in the SD Memory Card is copied to the SD Memory Card.	8-1 <i>SD Memory Card Operations</i> on page 8-4
Copying files and folders between the SD Memory Card and the computer	The selected file or folder in the SD Memory Card is copied to the computer. Or, the selected file or folder in the computer is copied to the SD Memory Card.	8-1 <i>SD Memory Card Operations</i> on page 8-4

Item	Description	Page
Backup functions	You can back up, restore, and compare the user program and other data of the NJ/NX-series CPU Unit or NY-series Industrial PC to replace hardware, such as the CPU Unit, or to restore device data.	8-10 <i>Backup Functions</i> on page 8-70
Controller backup	You can back up data (user program and settings, variable values, memory values, Unit settings, and slave settings) from a Controller to a file or restore the backed up data from the file to the Controller.	8-10-1 <i>Controller Backup Functions</i> on page 8-71
SD Memory Card backup	You can backup the Controller data to an SD Memory Card mounted in the NJ/NX-series CPU Unit or to the Virtual SD Memory Card of the NY-series Industrial PC, or compare the Controller data to the data in these SD Memory Cards.	8-10-2 <i>SD Memory Card Backup Functions</i> on page 8-75
Variables and memory backup	You can back up the contents of retained memory to a file and restore the contents of the backup file. You can individually select the Retain variables to restore.	8-10-3 <i>Backing Up Variables and Memory</i> on page 8-76
Importing/exporting to/from backup files	You can import the data in a backup file created for a Controller backup or SD Memory Card backup to a project. Also, you can export project data to a backup file.	8-10-4 <i>Importing/Exporting Backup Files</i> on page 8-84

3-7-10 Security Measures

Item	Function	Page
Prevention of incorrect connections	Confirming CPU Unit names and the Serial ID If the name or the serial ID is different between the project and the CPU Unit when an online connection is established, a confirmation dialog box is displayed.	6-2-6 <i>Confirming the Serial ID</i> on page 6-8
Prevention of incorrect operation	Operation authority verification You can set any of five levels of operation authority (Administrator, Designer, Maintainer, Operator, and Observer) for a Sysmac Studio project file, NJ/NX-series CPU Unit or NY-series Industrial PC to restrict the operations that can be performed according to the operation authority of the user.	8-3-2 <i>Operation Authority Verification</i> on page 8-11
	User authentication The Sysmac Studio authenticates each user who attempts to go online with the Controller to identify the user who performs online operations.	8-3-3 <i>User Authentication</i> on page 8-19
	Write protection of the CPU Unit You can prevent the Sysmac Studio from overwriting data in the CPU Unit.	8-3-5 <i>Write Protection of the CPU Unit</i> on page 8-37
	Firmware update prohibition You can choose Use or Do not use the Firmware update prohibition option.	For details on firmware updates, please contact OMRON sales representatives.

Item	Function	Page	
Prevention of the theft of assets	Authentication of user program execution IDs	You can ensure that a user program cannot be operated on another CPU Unit even if copied.	8-3-4 <i>Authentication of User Program Execution IDs</i> on page 8-34
	User program transfer with no restoration information	The program source code is not transferred. If this option is selected, programs are not displayed even if uploaded from another computer. However, variables and settings are transferred even if this option is selected.	7-5-1 <i>Transferring/Comparing Data to/from the Controller</i> on page 7-127
	Password protection for project files	You can set password protection for project files to protect your assets.	3-3-9 <i>Password Protection for Project Files</i> on page 3-22
	Data protection	You can set passwords for individual POUs (programs, functions, and function block definitions) to prohibit displaying, changing, and copying them.	8-3-6 <i>Data Protection</i> on page 8-39
	Library Without Source Code	You can create a library without source code. This library prevents leakage of source code from the library.	9-3-1 <i>Creating a Library</i> on page 9-8
	Secure communications	Encrypting and hashing the data sent and received between Sysmac Studio and the Controller can prevent a third party from sniffing and falsifying data.	For details on the function, refer to the <i>NJ/NX-series CPU Unit Software User's Manual (Cat. No. W501)</i> .
	Secure communication version	The protection level of secure communication can be set depending on the secure communication version.	8-3-1 <i>Secure Communications Setting</i> on page 8-9
	TCP/UDP port close	To block unnecessary packets, you can close a TCP/UDP port for the built-in EtherNet/IP port.	For details on the function, refer to the <i>NJ/NX-series CPU Unit Built-in EtherNet/IP Port User's Manual (Cat. No. W506)</i> .
	Packet filter	You can filter IP packets in the receiving process in the built-in EtherNet/IP port to limit access from an external device.	
Secure socket settings	The settings enable the secure socket services for the built-in EtherNet/IP port.		
Non-repudiation	Access logging	Sysmac Studio records an operation that a user made for the Controller using a tool as an access log. In the case the user authentication is enabled, you can register usernames to critical access logs for security reasons. This function allows you to confirm when who did what and works as the non-repudiation.	For details on the function, refer to the <i>NJ/NX-series CPU Unit Software User's Manual (Cat. No. W501)</i> .
	Firmware update log	You can confirm the firmware update log in the Controller.	

3-7-11 Customizing Function

Item	Function	Page
Option settings	You can change the color theme, display of each program editor, and program check method as required.	8-26 <i>Sysmac Studio Option Settings</i> on page 8-166
Import and export	You can export option settings and import them to another environment.	8-26 <i>Sysmac Studio Option Settings</i> on page 8-166

Item	Function	Page
Shortcut key allocation	You can change the shortcut keys allocated for the main menu and context menus of the ladder editor.	<i>A-6-7 Changing Shortcut Keys</i> on page A-29

3-7-12 Window Operation

Item	Description	Page
Docking	You can dock and undock configuration tab pages, program editors, Watch Tab Pages, Cross Reference Tab Page, and other window parts to/from the main Sysmac Studio window.	<i>3-4-5 Changing the Display Location of Window Parts</i> on page 3-44

3-7-13 Online Help

Item	Description	Page
Sysmac Studio help system	You can access Sysmac Studio operating procedures.	<i>A-5 Online Help</i> on page A-23
Instructions reference	Information is provided on how to use the instructions that are supported by the NJ/NX-series CPU Unit or NY-series Industrial PC.	
System-defined Variable Reference	You can display a list of descriptions of the system-defined variables that you can use on the Sysmac Studio.	
Keyboard mapping reference	You can display a list of convenient shortcut keys that you can use on the Sysmac Studio.	
Manual download	You can access manual download page of the web site from the Sysmac Studio and download the latest Sysmac Studio related manuals.	<i>A-13 Downloading Manuals</i> on page A-97

3-7-14 OPC UA Functions

Item	Description	Reference
Setting Parameters	---	Refer to the <i>NJ/NX-series CPU Unit OPC UA User's Manual</i> (Cat. No. W588) for details on functions.
OPC UA Settings	Settings for OPC UA.	
OPC UA Server Settings	Settings for OPC UA Server operation set from the OPC UA Server Settings tab.	
Settings and display for Certificate	Displays Server Certificate and allows users to manipulate it. Also displays Client and Issuer Authentication of Certificate List and Revocation List, and allows users to manipulate them.	
Security Settings	Sets up user name or password to authenticate, prohibits or permits anonymous login, sets security policy to permit as a server and transfers the settings to the CPU Unit.	
Programming function	---	
Creation of variables for OPC UA communications	Creates variables to be used for OPC UA communications.	
Publishing of variables to OPC UA communications	To publish variables to the OPC UA communications, the Network Publish attribute of the variables is set to <i>Publish Only</i> , <i>Input</i> , or <i>Output</i> .	
Shutdown instruction	Requests termination of OPC UA Server and make the system power down safely. Instruction name: OPCUA_Shutdown	
Monitoring information	---	
Server Status	Displays the operating status of the OPC UA Server and terminates (shutdown) the OPC UA Server.	
Operation Log Window	Displays the list of operation logs and allows users to manipulate them.	

3-7-15 Function Specifications of DB Connection Function

Item		Description	Reference
Setting Parameters		---	Refer to the <i>NJ/NX-series Database Connection CPU Units User's Manual (Cat. No. W527)</i> for details on functions.
	DBMS settings	The database to connect is selected.	
	Run mode setting of the DB connection service	Operation Mode is selected to send SQL statements when DB connection instructions are executed or Test Mode is selected to not send SQL statements when DB connection instructions are executed.	
	Spooling settings	You can set the service so that SQL statements are spooled when problems occur and resent when operation is restored.	
	Operation log settings	Settings are made for the execution log for execution of the DB connection service, the debug log for execution of SQL statements for the DB connection service, and the SQL execution failure log for SQL execution failures.	
	DB connection function shutdown settings	Settings are made to control operation in order to end the DB connection service after automatically storing the operation log files on an SD Memory Card.	
Program- ming	DB connection instructions	You can use the following DB connection instructions to write the user program for controlling the data in the database. DB_Insert (Insert DB Record) DB_Select (Retrieve DB Record) DB_Update (Update DB Record) DB_Delete (Delete DB Record)	
Monitoring information		---	
	Monitoring the DB connection service	The status of the DB connection service is monitored.	
	Monitoring the DB connections	The status of each DB connection is monitored.	
	Displaying the operation logs	The contents of the execution log, debug log, and SQL execution failure log are displayed.	

3-7-16 CNC Functions

Item		Description	Reference
Setting Parameters		---	Refer to the <i>NJ/NY-series NC Integrated Controller User's Manual (Cat. No. O030)</i> for details on functions.
	CNC Setup	You can register the CNC coordinate system and CNC motors to use with CNC instruction. You can also assign the Servo Drives to the CNC motors and configure the CNC motor parameters.	
	CNC Coord Settings	The coordinate system is added to the project and you can assign CNC motor to the coordinate system.	
	CNC Motor Settings	The CNC motor is assigned to the project and you can configure its parameters.	
	CNC Motor Compensation Table	The CNC Motor Compensation Table is assigned to the project and you can set the CNC motor compensation data.	
Program- ming	NC Program- ming	You can create the NC Program by using G Code language.	

3-7-17 EtherNet/IP Connection Settings

Item		Description	Reference
EtherNet/IP Connection Settings		Functions related to tag data link (connection) settings in the EtherNet/IP network are provided.	Refer to the <i>NJ/NX-series CPU Unit Built-in EtherNet/IP Port User's Manual (Cat. No. W506)</i> or <i>NY-series Industrial Panel PC / Industrial Box PC Built-in EtherNet/IP Port User's Manual (Cat. No. W563)</i> for details on functions.
Setting Connections	Editing Tag Sets	You create tags and tag sets using network variables.	
	Editing Target Devices	You add target devices to connect to.	
	Editing Connections	You select tag sets from a list and create connections.	
	Adding EDS Files	You can add the types of EtherNet/IP devices that can be set as targets.	
Transferring Connections	Synchronized Transfer and Batch Transfer	All the connection settings in the Controller or the project are transferred at the same time.	
	Individual Transfer and Comparison	You can transfer or compare the connection settings of each EtherNet/IP device individually.	
Monitoring Connections	Status Monitor	The operating status of one or more connections is displayed. You can start or stop all the connections at the same time.	
	Tag/Tag Set Monitor	The detailed operation information of tags and tag sets, such as the presence or absence of tags and the connection times of tag sets, is displayed.	
	Ethernet Information Monitor	The detailed operation information of EtherNet/IP devices, such as bandwidth usage (pps), is displayed.	

3-7-18 EtherNet/IP Slave Terminal Settings

Item		Description	Reference
EtherNet/IP Slave Terminal Configuration and Setup		You create the configuration of a Slave Terminal to be connected to the EtherNet/IP network on the Sysmac Studio and set the NX Units that compose the Slave Terminal.	Refer to the <i>NX-series EtherNet/IP Coupler Unit User's Manual (Cat. No. W536)</i> for details on functions.
Registering the NX Units		You configure the Slave Terminal by dragging the NX Units from the device list displayed in the Toolbox to the positions where to mount the Units.	
Setting the NX Units		You edit the I/O allocation settings, mounting settings and Unit operation settings of the NX Units.	
Displaying the Width of a Slave Terminal Configuration		The width of the Slave Terminal configuration is displayed based on the Unit configuration information.	
Comparing and Merging Slave Terminal Configuration Information		You can compare the configuration information on the project with actual configuration online, select the Units with different information to correct, and merge the information.	
Transferring the Slave Terminal Configuration Information		You transfer the Unit configuration information to the Slave Terminal.	

3-7-19 PROFINET Slave Terminal Settings

Item	Description	Reference
PROFINET Slave Terminal Configuration and Setup	You create the configuration of a Slave Terminal to connect to the PROFINET network on the Sysmac Studio and set the NX Units that compose the Slave Terminal.	Refer to the <i>NX-series PROFINET Coupler Unit User's Manual(W623-E2)</i> for function details.
Registering the NX Units	You configure the Slave Terminal by dragging the NX Units from the device list displayed in the Toolbox to the positions where to mount the Units.	
Setting the NX Units	You edit the I/O allocation settings, mounting settings and Unit operation settings of the NX Units.	
Displaying the Width of a Slave Terminal Configuration	The width of the Slave Terminal configuration is displayed based on the Unit configuration information.	
Comparing and Merging Slave Terminal Configuration Information	You can compare the configuration information on the project with actual configuration online, select the Units with different information to correct, and merge the information.	
Transferring the Slave Terminal Configuration Information	You transfer the Unit configuration information to the Slave Terminal.	

3-7-20 Function Specifications of Safety Control Units

Item		Description	Reference
Project Management	Safety: Offline Comparison	You can compare the safety application data in currently opened project file and an exported project file. In addition, it is possible to merge programs and variable table in the detail comparison results.	Refer to the <i>NX-series Safety Control Unit User's Manual (Cat. No. Z930)</i> for details on functions.
Setting Parameters		---	
Safety I/O Settings		You make a setting for safety process data communications and connection with safety I/O devices.	
	Safety Process Data Communications Settings	You select Safety I/O Units to perform safety process data communications (FSoE communications) and make necessary settings.	
	Safety Device Allocation Settings	You set the connection between Safety I/O Units and safety devices.	
SRA Parameter Settings		You can configure safety functions and parameter settings of 1S-series Servo Drive.	
EtherNet/IP Safety Connection Settings		You can register target devices of EtherNet/IP Safety network and configure the connection settings.	
Standard I/O Settings	Exposed Variable Settings	You set whether to expose global variables of the Safety CPU Unit. The values of exposed variables can be referenced from NJ/NX-series CPU Units and NY-series Industrial PCs.	
	Standard Process Data Communications	You set the devices and ports of the Standard I/O Units for the exposed variables of the Safety CPU Unit.	
Safety Task Settings		You define the execution cycle and timing of the safety task and programs to be executed in the task.	
	Assigning Programs	You assign safety programs to execute to the task.	
I/O Map Settings		The ports of Safety I/O Units used in safety process data communications are displayed. You assign device variables used in safety programs to the I/O ports.	
	Export/ Import	I/O map settings can be exported to and imported from a CSV file.	

Item	Description	Reference
Creating Safety Programs	---	Refer to the <i>NX-series Safety Control Unit User's Manual (Cat. No. Z930)</i> for details on functions.
Instruction List (Toolbox)	A hierarchy of the functions and function blocks that you can use is displayed in the Toolbox. You can drag the required functions and function blocks onto the FBD editor to insert it to a safety program.	
FBD Programming	You connect variables, functions, and function blocks with connecting lines to build networks. The FBD editor is used to enter them.	
Adding FBD Networks	You create FBD networks on the FBD editor to create algorithms.	
Inserting and Deleting Functions and Function blocks	You insert and delete functions and function blocks on the FBD editor.	
Entry Assistance	When you enter functions, function blocks, or parameters, each character that you enter from the keyboard narrows the list of candidates that is displayed for selection.	
Commenting Out FBD Networks	You can comment out each FBD network. When a network is commented out, it is no longer executed.	
Program Pattern Copy	You can duplicate an FBD program with the same program pattern (logic part). The variable name of the program can be set automatically according to the variable name generation rules.	
Converting Programs into Function Blocks	You can convert the safety program into user-defined function block.	
Automatic Programming	A safety programs can be automatically generated from input and output signals and expected values of the program.	
Creating Variables	You create variables used in safety programs in the global or local variable table.	
User-defined Function Blocks	You create user-defined function blocks.	
Help Reference	You can display the user-defined function block help with the popup menu or shortcut key.	
Export/Import	POUs can be exported and imported.	
Programs	You can export/import POUs.	
User-defined Function Blocks	You can export/import user-defined function blocks.	
IEC 61131-10 XML	You can import the IEC 61131-10-compliant XML programs, function block POUs, and global variables.	

Item	Description	Reference
Searching and Replacing	You can search for and replace strings in the variable tables, programs, and function blocks of a Safety CPU Unit.	
Retrace Search	If the selected variable is used as an output in the program, you can jump to the place where the selected variable is used as an input. If the selected variable is used as an input in the program, you can jump to the place where the selected variable is used as an output.	
Deleting Unused Variables	You can delete all unused variables in a program at once.	
Variable Comment Switching	Variable comments shown in safety programs and variable table can be collectively replaced to other comments. You can switch the language of comments for users in other countries.	

Item	Description	Reference
Debugging	---	Refer to the <i>NX-series Safety Control Unit User's Manual (Cat. No. Z930)</i> for details on functions.
Monitoring	Variables are monitored during safety program execution. You can monitor the present values of device variables assigned to Safety I/O Units and user-defined variables. The values can be monitored on the FBD editor or Watch Tab Page.	
Changing the Present Values of Variables	You can change the present values of user-defined variables and device variables as required. You can do this on the FBD editor or Watch Tab Page.	
Forced Refreshing	The inputs from external devices and outputs to external devices are refreshed with a specified value on the Sysmac Studio. The specified value is retained even if the value of the variable is overwritten from the user program. You can use forced refreshing on the FBD editor or Watch Tab Page.	
Cross References	It is possible to see in which programs and in which place a safety program variable is used.	
Offline Debugging	You can check if the control program logic works as designed in advance using a special debugging function for the Simulator without connecting online with the Safety CPU Unit.	
Initial Value Settings	You can set the initial values of variables when you start execution of simulation.	
Feedback Settings	You can set input status that is linked to changes in output status when simulator is running.	
Simple Automatic Test	You can check that expected values of the outputs to the inputs of the program are designed as intended using the Simulator functions of the Safety CPU Unit.	
User Memory Usage Monitor	The memory usage of the safety control system and usage of safety network such as I/O data size are displayed.	
Online Functional Test	This function helps you to check the safety functional operation of the safety system. You can produce output device operation relative to the input and check whether the system operates as expected. It is possible to output the check results.	
Searching for Function Block related to the safety output Off in a Safety Program	You can search for a function block that may be related to the safety output Off in a currently running safety program.	
CIP Safety Monitor	You can monitor device status of the CIP Safety target devices, connection status to the Safety CPU Unit, and parameter values.	
Safety	Safety Validation	You append the <i>safety-validated</i> information to a safety program when you can ensure safety of the program after you complete debugging.
	Changing Operating Mode	There are four operating modes; PROGRAM mode, DEBUG mode (STOPPED), DEBUG mode (RUN), and RUN mode. The RUN mode can be selected only for the validated safety programs.

Item		Description	Reference
Maintenance	Generating Safety Data Logging Settings File	Settings to use the safety data logging function can be generated as a file.	Refer to the <i>NX-series Safety Control Unit User's Manual (Cat. No. Z930)</i> for details on functions.
	Generating Safety Unit Restore File	A file of safety program and settings to be transferred to the Safety CPU Unit using an SD memory card is generated for Safety Unit Restore function.	
Security Measures		---	
Prevention of Incorrect Connections	Setting the Node Name	You set a unique name for each Safety CPU Unit to confirm that you operate the correct Safety CPU Unit.	
Prevention of Incorrect Operation	Safety Password	You can prevent unauthorized access to safety functions of Safety CPU Units by setting a safety password for online operations that affect the safety functions.	
Prevention of the Theft of Assets	Data Protection (Programs)	You can set passwords for individual programs to prohibit displaying or changing them.	
	Data Protection (User-defined Function Blocks)	You can set passwords for individual user-defined function blocks to prohibit displaying or changing them.	

3-7-21 Function Specifications of NA-series Programmable Terminals

Item	Function	Reference
Parameter Settings	---	Refer to the <i>NA-series Programmable Terminal Software User's Manual (Cat. No. V118)</i> for details on functions.
Device references	Devices, such as Controllers, through which the NA-series PT can read and write information with communications are created on the Sysmac Studio and settings are made for them.	
Displaying internal devices	Controllers that were created in the project are displayed.	
Registering external devices	Devices, such as Controllers, that were not created in the project are registered. The communications settings of the devices to communicate with the NA-series PT and information, such as variables and addresses within the devices that the NA-series PT will read and write, are also registered.	
Mapping variables	The information on the devices registered in the device references, such as variables and addresses, are mapped to the global variables of the NA-series PT.	
HMI settings	Settings for NA-series PT operation are made.	
Device settings	Settings, such as the startup page, default language, layout of the USB keyboard, automatic logout, screen saver, screen brightness, and method to change to the System Menu, are made.	
TCP/IP settings	Settings for the Ethernet port that is built-in to the NA-series PT are made.	
FTP settings	Settings to communicate with FTP clients using the Ethernet port are made.	
NTP settings	Settings to communicate with an NTP server using the Ethernet port are made.	
FINS settings	Settings to communicate with devices that support FINS are made.	
VNC settings	Settings to communicate with VNC clients using the Ethernet port are made.	
Print settings	Print settings are made.	
Serial port settings	Settings for the built-in serial port in the NA-series PT are made.	
Security settings	Settings, such as user registration and permissions to restrict NA-series PT operation and displays, are made.	
User account settings	The user names, login passwords, and permissions for each user to operate the NA-series PT are set.	
Permission and access level settings	The range of information that can be accessed for different permissions are set.	
Troubleshooter	Troubleshooter settings are made.	
Language settings	Language settings to perform multi-language displays on the NA-series PT are made.	
Operation log settings	Settings to take operation logs in the NA-series PT are made.	

Item	Function	Reference
Creating Data and Programming	---	Refer to the <i>NA-series Programmable Terminal Software User's Manual (Cat. No. V118)</i> for details on functions.
Editing pages	The pages to display on the NA-series PT are edited.	
Adding and deleting pages	Pages are added, deleted, or copied with the Multiview Explorer. Pages can also be copied to other projects.	
Adding and deleting page groups	Groups to organize and manage pages on the Multiview Explorer are added and deleted. Pages can be added to or moved to the groups.	
Page properties settings	The page type, overlapping, background color, etc., are set in the Properties Window.	
Changing the display language	If using multiple languages is set in the language settings, the resources displayed on the Page Editor are displayed in the language set for each resource.	
Changing the display status of each object	You can check display status changes for lamp and other objects on the Page Editor.	
Displaying object configuration	The objects and groups that were added to each page can be confirmed in a tree structure using the Page Explorer.	
Adding objects	Objects, such as buttons or graphics, to display on a page are added by dragging them from the Toolbox to the Page Editor.	
Grouping objects	Settings to operate multiple objects together as a group are made.	
Aligning objects	Multiple objects are aligned.	
Editing objects	Objects and groups can be copied within a page or to another page. Objects can also be deleted, and locations, sizes, rotations, and position relationships with other objects can be set. Also, labels can be edited.	
Setting object entry order	Entry order of Data Edit objects can be set.	
Object property settings	Properties, such as the colors and shapes of objects and the mapped variables, can be changed. Properties are displayed and changed in the Properties Window.	
Duplicating objects	You can duplicate a specified number of objects. Offsets are set to the element numbers of the array set for the object.	
Animation settings	Animation to modify dynamically the appearance of objects are set. Animation is displayed and changed in the Animation Window.	
Event and action settings	The events that can be set for objects and the actions that can be executed when an event occurs are set. Displaying and changing the settings for events and actions is performed in the Events and Actions Window.	
Import and export	Text, variables and conditional expressions of some objects can be imported from or exported to an Excel file.	
Page import and export	Pages can be imported and exported.	

Item	Function	Reference	
Creating Data and Programming	---	Refer to the <i>NA-series Programmable Terminal Software User's Manual (Cat. No. V118)</i> for details on functions.	
Programming with Visual Basic	Subroutines are created with Visual Basic.		
Language specifications	Visual Basic 2008 and .NET Compact Framework 3.5 are supported.		
Adding subroutine groups	Groups to organize and manage global subroutines on the Multiview Explorer are added or deleted. Subroutines can be added or moved to the groups.		
Editing subroutines	Subroutines are created using the Code Editor, which is optimized for Visual Basic.		
Bookmarks	Bookmark can be added to any code line and you can move between the bookmarks.		
Data entry assistance	The characters that are entered from the keyboard are used to display candidates when entering source code.		
User alarms	Settings for detection conditions and displaying messages for user alarms are made.		
Adding and deleting user alarm groups	Groups to organize and manage user alarms on the Multiview Explorer are added or deleted. User alarms can be created in the groups.		
Registering and deleting User Alarm	Settings for detection conditions for user alarms and displaying messages or popup pages are made for user alarm groups.		
Copying user alarms	User alarms can be copied within a group or to another group.		
Event and action settings	Events and the actions that are executed when the events occur are set for the user alarms. Displaying and changing the settings for events and actions is performed in the Events and Actions Window.		
Import and export	User alarms and user-alarm text strings can be imported from or exported to an Excel file.		
Controller events	User-defined event settings		Settings for pages that can be changed from user-defined events' display in Troubleshooter.
Data logging	Data logging is set to log specified data in the NA-series PT at the specified times.		
Adding and deleting data sets	Data sets are added to perform data logging.		
Log condition setting	Conditions to perform data logging and target global variables are set for the data sets.		
Broken-line graph	Settings for the data that is displayed in a broken-line graph.		
Adding and deleting data groups	Data groups for which a broken-line graph is drawn are added and deleted.		
Log condition setting	Conditions to display a broken-line graph and target global variables are set for data groups.		

Item	Function	Reference
Creating Data and Programming	---	Refer to the <i>NA-series Programmable Terminal Software User's Manual (Cat. No. V118)</i> for details on functions.
Recipes	Data groups that are retained in the NA-series PT and can be switched for user requests are set.	
Adding and deleting templates	Data storage locations, value ranges, and data names are added or deleted.	
Recipe data settings	The actual data is set for each recipe.	
Keypad customization	Keypads can be customized.	
Global events	The events that are detected on any page and the actions that are executed when the events occur are set.	
Resource management	All of the character strings and graphics that are displayed on pages are managed. Also, registered resources can be indirectly accessed.	
Registering and deleting general character strings	The character strings that are displayed on pages are registered and deleted, except for character strings used for user alarms.	
Registering and deleting character strings for user alarms	The character strings used for user alarms are added or deleted.	
Registering and deleting document files	Document files that are displayed with the Document Viewer are set or deleted.	
Registering and deleting image files	Image files that are displayed for objects are set or deleted.	
Registering and deleting movies	Movie files that are displayed for Media Player objects are set or deleted.	
Importing and exporting	The general character strings and alarm character strings can be imported and exported using Excel files.	
Exporting Image files	The registered image files can be exported.	
Scaling	Values of variables and objects are converted by a specified scaling factor set for them.	
Searching and replacing	You can search all strings in a project to find and replace a specified string.	
Device replace	You can replace a device, which has been mapped by using a variable, with another device.	
Cross reference	Where a specified program element (variable, data type, page, or resource) is used in a project can be checked with a list. You can access the use locations of the element from the list.	
Building	The project is converted into a format that can be executed in the NA-series PT.	

Item	Function	Reference	
Reusability	---	Refer to the <i>NA-series Programmable Terminal Software User's Manual (Cat. No. V118)</i> for details on functions.	
IAGs (intelligent application gadgets)	Multiple objects and subroutines are combined to create a reusable object.		
Creating IAGs	An IAG that consists of multiple objects and subroutines is created as a functional unit in an IAG project.		
Creating IAG collection files	A created IAG is built and saved as a module that can be distributed and reused.		
Creating user-defined events	You can create user-defined events that can be used in an IAG.		
Using IAGs	IAG collection files are imported using the IAG Collection Manager. The imported IAGs are displayed in the Toolbox and can be used in the same way as other objects.		
Replacing IAG	You can replace an existing IAG with any other IAG.		
Custom objects	The selected objects are registered in a reusable format in the Toolbox.		
Registering custom objects	Objects or grouped objects are dragged to the Toolbox to register them.		
Using custom objects	Custom objects are displayed on a page by dragging them from the Toolbox to the Page Editor.		
File Operations	Import/Export		The data in the NA-series PT can be exported and saved as a file and the data can be imported from the file to a project.
	Synchronization		The data in the NA-series PT that is online is compared with the data in the Sysmac Studio. You can check the differences and then transfer the data after specifying the transfer direction.
	Transferring files via storage media		The data in a storage media in the computer is compared with the data in the Sysmac Studio. You can check the differences and then transfer the data to the storage media. You can use the System Menu to transfer a saved project file to the NA-series PT.
	Clearing all memory	All of the data except for the clock information is deleted from the NA-series PT.	
Simulation	---		
	Executing simulations	A project file on the computer is virtually executed to debug it.	
	Setting and clearing breakpoints	Breakpoints can be set at the specified positions in a subroutine.	
	Synchronized simulation with Controller Simulator	Sequence control and NA-series PT operation, such as displaying pages and subroutine operation, is simulated together to debug the application in the NA-series PT.	
Monitoring Information	Setting clock information	The clock information in the NA-series PT can be checked and set.	

Item		Function	Reference
Communications	Going online with NA-series PT	The computer can be placed online with the NA-series PT. However, information in the NA-series PT, such as the values of variables, cannot be read.	Refer to the <i>NA-series Programmable Terminal Software User's Manual (Cat. No. V118)</i> for details on functions.
	Upgrading system program	When the Sysmac Studio is online with the NA-series PT, the system program in the NA-series PT can be upgraded as required.	
Print	Printing	Settings of each project can be printed out.	
Security	Preventing malfunctions	If the name or serial ID of the project and the NA-series PT are different when the Sysmac Studio goes online, a confirmation dialog box is displayed.	
	Preventing incorrect operation	You can prevent data in the NA-series PT from being overwritten from the Sysmac Studio.	

3-7-22 Vision Sensor Functions

● FH-series Vision Sensors

Item		Description	Reference
Setting Parameters		---	Refer to the <i>Vision System FH/FHV Series Operation Manual for Sysmac Studio (Cat. No. Z343)</i> for details on functions.
Main editing	Sensor Information	The basic information on the Sensor is displayed and set.	
	Online	You can change the connection status between the computer and Sensor and use various controls (e.g., restarting and initializing a Sensor).	
Line editing	Monitor Tab Page	You can monitor Sensor measurement images and detailed results from processing units.	
	Scene Maintenance Tab Page	You can edit, manage, and save scenes and scene groups.	
Editing scene data	Editing the flow	You can combine the required processing units to create a processing flow.	
	Editing processing units	You can edit processing units.	
Editing system data	Camera settings	You can check Camera connection status, Camera image capture timing, and baud rates.	
	Controller settings	You can set up the Sensor's system environment.	
	Parallel I/O settings	You can make settings for output terminals.	
	RS-232C/422 settings	You can make settings for RS-232C/422 communications.	
	Ethernet communications settings	You can make settings for Ethernet communications.	
	EtherNet/IP settings	You can make settings for EtherNet/IP communications.	
	EtherCAT communications settings	You can make settings for EtherCAT communications.	
	PROFINET Communication Settings	You can make settings for PROFINET communications.	
Encoder settings	You can make settings for an encoder.		

Item		Description	Reference
Setting Parameters		---	Refer to the <i>Vision System FH/FHV Series Operation Manual for Sysmac Studio (Cat. No. Z343)</i> for details on functions.
Tools	I/O command customize tool	You can set your own communications commands.	
	File saving tool	You can copy or transfer files that are in Sensor memory.	
	Calibration support tool	You can check the calibration information.	
	User data tool	You can edit user data that is shared in the Sensor.	
	Security setting tool	You can edit the security settings of the sensor.	
	Scene group save destination setting tool	You can set the destination to save the scene group data.	
	Image file save tool	You can save the logging images and image files stored in the sensor memory.	
	Registered image management tool	You can save the images used for model registration and reference registration as registered images.	
	Reference position update tool	You can edit all reference positions of more than one processing unit.	
	Scene group data conversion tool	You can create the scene group data with more than 128 scenes.	
	Scene control macro tool	You can make a setting for complementing and expanding the measurement flow and scene control.	
	Conveyor calibration wizard tool	You can calibrate cameras, conveyors, and robots in a conveyor tracking application.	
	Calibration plate print tool	You can print out calibration patterns that are used in the Conveyor Calibration Wizard.	
	Conveyor panorama display tool	You can display a panoramic image in a conveyor tracking application.	
	Variable Assignment List	Shows a list of system and scene variable assignments registered to FH/FHV Vision Sensors.	
Quick Access Setting Tool	Defines identifier name, absolute path, and display name for Quick Access. Quick Access settings allows you to select Quick Access when specifying a file or folder path. Settings according to different environments enable path settings without considering environment-dependent drive configuration.		
Error Log Management Tool	Displays contents of the error log information files for the FH/FHV-series Vision Sensor while Sysmac Studio is online.		

Item		Description	Reference
Debugging	Offline debugging of Sensor operation	Measurement operation is simulated offline (i.e., without a connection to a Sensor). Image data is prepared in an external file, measurements are performed according to conditions that are set offline, and the results are displayed.	Refer to the <i>Vision System FH/FHV Series Operation Manual for Sysmac Studio (Cat. No. Z343)</i> for details on functions.
	Offline Debugging of Sensor Control Program and Sensor Operation	The linked operation of the sequence controls in the NJ/NX/NY-series Controller and the FH Sensor operation is simulated for an EtherCAT system. You can debug a series of operations offline to perform the measurement and other processing and output the results when a control signal such as measurement trigger is input to the Sensor.	
Security	Preventing incorrect operation	You can prevent unauthorized access by setting an account password for online operations.	

● FHV-series Vision Sensors

Item		Description	Reference
Setting Parameters		---	Refer to the <i>Vision System FH/FHV Series Operation Manual for Sysmac Studio (Cat. No. Z343)</i> for details on functions.
Main Edit	Sensor Information	The basic information on the Sensor is displayed and set.	
	Online	You can change the connection status between the computer and Sensor and use various controls (e.g., restarting and initializing a Sensor).	
Line Edit	Operation View	You can monitor Sensor measurement images and detailed results from processing units.	
	Scene Maintenance View	You can edit, manage, and save scenes and scene groups.	
Scene Data Edit	Flow Edit	You can combine the required processing units to create a processing flow.	
	Process Unit Edit	You can edit processing units.	
Sensor System Data Edit	Camera Settings	You can check Camera connection status, Camera image capture timing, and baud rates.	
	Controller Settings	You can set up the Sensor's system environment.	
	Parallel I/O Settings	You can make settings for output terminals.	
	RS-232C/422 Settings	You can make settings for RS-232C/422 communications.	
	Ethernet Communication Settings	You can make settings for Ethernet communications.	
	EtherNet/IP Communication Settings	You can make settings for EtherNet/IP communications.	
	EtherCAT Communication Settings	You can make settings for EtherCAT communications.	
	PROFINET Communication Settings	You can make settings for PROFINET communications.	
Encoder Settings	You can make settings for an encoder.		

Item		Description	Reference
Setting Parameters		---	Refer to the <i>Vision System FH/FHV Series Operation Manual for Sysmac Studio (Cat. No. Z343)</i> for details on functions.
Tools	File Saving Tool	You can copy or transfer files that are in Sensor memory.	
	Calibration Support Tool	You can check the calibration information.	
	Security Setting Tool	You can edit the security settings of the sensor.	
	Registered Image Management Tool	You can save the images used for model registration and reference registration as registered images.	
	Scene Group Data Conversion Tool	You can create the scene group data with more than 128 scenes.	
	Variable Assignment List	Shows a list of system and scene variable assignments registered to FH/FHV Vision Sensors.	
	Error Log Management Tool	Displays contents of the error log information files for the FH/FHV-series Vision Sensor while Sysmac Studio is online.	
Debugging	Offline Debugging of Sensor Operation	Measurement operation is simulated offline (i.e., without a connection to a Sensor). Image data is prepared in an external file, measurements are performed according to conditions that are set offline, and the results are displayed.	
	Offline Debugging of Sensor Control Program and Sensor Operation	The linked operation of the sequence controls in the NJ/NX-series CPU Unit or NY-series Industrial PC and the FHV Sensor operation is simulated for an EtherCAT system. You can debug a series of operations offline to perform the measurement and other processing and output the results when a control signal such as measurement trigger is input to the Sensor.	
Security	Prevention of Incorrect Operation	You can prevent unauthorized access by setting an account password for online operations.	

● FQ-M-series Vision Sensors

Item		Description	Reference
Setting Parameters		---	Refer to the <i>FQ-M-series Specialized Vision Sensor for Positioning User's Manual (Cat. No. Z314)</i> for details on functions.
Main editing	Basic Settings	The basic information on the Sensor is displayed and set.	
	Sensor connection	You can change the connection status between the computer and Sensor, and set the conditions for communications.	
	Online Sensor controls	Various controls are performed for the online Sensor (e.g., changing the mode, transferring data, and starting monitoring).	
	Sensor error history	You can display or clear the error history of the online Sensor.	
	Tools	You can restart the Sensor, initialize the Sensor, update the firmware of the Sensor, read Sensor data, save Sensor data, print the Sensor parameters, and display help.	
Editing scene data	Setting imaging conditions	You can adjust the imaging conditions.	
	Specifying calibration patterns	You can select a registered calibration pattern.	
	Registering inspection items	You can register the inspection items to use in the measurements. You can select from the following inspection items: Edge Position, Search, Labeling, and Shape Search.	
	Setting calculations	You can set basic arithmetic operations and function operations using inspection item judgment results and measurement data.	
	Setting the items to log	You can make the settings for logging, such as setting the measurement results of inspection items and calculation results.	
	Setting output data	You can set the data to output to external devices.	
	Settings for operation	You can change the mode of the Sensor or start monitoring of measurement results.	
Editing system data	Setting trigger conditions	You can set the trigger types and timing for imaging.	
	Setting I/O	You can make settings for the output terminals. You can check the condition of I/O wiring for the online Sensor.	
	Setting the encoder	You can make settings for the encoder, such as the common encoder settings, ring counter settings, and encoder trigger settings.	
	Setting Ethernet communications	You can make settings for Ethernet communications. You can select any of the following for data I/O: no-protocol data, PLC link data, and programmable no-protocol data.	
	Setting EtherCAT communications	You can make settings for EtherCAT communications. Set the communications settings to match those of the EtherCAT master.	
	Setting logging conditions	You can set the conditions to log data to the internal memory of the Sensor.	
	Sensor settings	You can set the startup scene control function, password setting function, and judgment condition adjustment function.	
Setting calibration scene data		You can calculate, check, and edit the calibration parameters. Both general-purpose calibration and calibration for conveyor tracking are provided.	

Item		Description	Reference
Debug- ging	Offline debugging of Sensor operation	Measurement operation is simulated offline (i.e., without a connection to a Sensor). Image data is prepared in an external file, measurements are performed according to conditions that are set offline, and the results are displayed.	Refer to the <i>FQ-M-series Specialized Vision Sensor for Positioning User's Manual (Cat. No. Z314)</i> for details on functions.
	Offline debugging of Sensor control programs and Sensor operation	The linked operation of the sequence controls in the NJ/NX/NY-series Controller and the FQ-M Sensor operation is simulated for an EtherCAT system. This enables offline debugging of processing for measurements and outputting results when measurement triggers and other control signals are input to the Sensor.	

Note Not supported by the Sysmac Studio (64 bit).

3-7-23 Displacement Sensor Functions

Item		Description	Reference
Setting Parameters		---	Refer to the <i>ZW-series Confocal Fiber Type Displacement Sensor User's Manual (Cat. No. Z332)</i> for details on functions.
Main editing	Basic Settings	The basic information on the Sensor is displayed and set.	
	Sensor connection	You can change the connection status between the computer and Sensor, and set the conditions for communications.	
	Online Sensor controls	You can perform various controls for the Sensor online (e.g., changing the mode, controlling internal logging, and monitoring).	
	Tools	You can restart the Sensor, initialize the Sensor, update the firmware of the Sensor, recover ROM data, print the Sensor parameters, and display help.	
Editing bank data	Setting sensing conditions	You can adjust the light reception conditions for each measurement region.	
	Setting task conditions	You can select the measurement items to use in measurements. You can select from the height, thickness, or calculations.	
		The following are set for the measurement items: scaling, filters, holding, zero-resetting, and judgement conditions.	
Setting I/O conditions	You can set parameters for outputting judgements and analog values to external devices.		
Editing system data	Sensor settings	You can set the following: ZW Sensor Controller's key lock, number of displayed digits below the decimal point, the bank mode, the analog output mode, and timing/reset key inputs.	
	Setting Ethernet communications	You can set Ethernet communications and field bus parameters.	
	Setting RS-232C communications	You can make settings for RS-232C communications.	
	Data output settings	You can set serial output parameters for holding values.	
Monitoring	Sensor monitoring	You can monitor the light-detection status and the measurement results of the sensor.	
	Trend monitoring	You can log and monitor the measurement results that meet the specific conditions of the sensor.	
Debugging	Offline debugging of Sensor control programs and Sensor operation	The linked operation of the sequence controls in the NJ/NX/NY-series Controller and the ZW Sensor operation is simulated for an EtherCAT system. This allows you to simulate the operation of signals when timing signals and other control signals are input to the Sensor to debug the control logic offline.	

3-7-24 Team Development Option

Item		Description	Reference
Project version control function		You can control a project version in concert with the version control system (Git™).	Refer to the <i>Sysmac Studio Project Version Control Function Operation Manual</i> (Cat. No. W589) for details on functions.
History management	Showing the project log	You can see the change history of project data in a branch, local repository, and remote repository.	
	Comparing projects	You can compare specific revisions from the project change history.	
	Reverting a project	You can restore a project to any revision.	
Multiple-person development	Developing a program concurrently	You can develop controller programs per POU concurrently. The changes of concurrent development are merged automatically.	
Derivative development	Creating a branch	You can create and edit data derived from a master project.	
	Merging	Changes in a branch are automatically reflected in the master data.	

3-7-25 3D Simulation Function

The function is supported by the Sysmac Studio (64 bit) only.

Item		Description	Reference
3D Simulation		This function enables to check the followings visually on a PC: behaviors of the equipment controlled by NJ/NX/NY Controllers and conveyance of parts to be processed or assembled.	Refer to the <i>Sysmac Studio 3D Simulation Function Operation Manual (Cat. No. W618)</i> for details on functions.
Adding 3D object	3D CAD Data	Adds 3D CAD data.	
	Cylinder	Adds a cylinder.	
	Box	Adds a box.	
	Mechanical Component*1	Adds a mechanical component controlled by I/O or motion axis.	
	Virtual Part Detection Sensor	Adds a virtual sensor to detect a part position.	
	Custom Mechanics	Adds custom mechanics that any movable parts can be configured.	
	Parallel Link Mode	Adds a parallel link model.	
Shape Script	Adding a program	Adds a program to replicate the part behavior on a 3D simulation.	
	Programming	Edit a program with Shape Script Editor.	
	Automatic generation of a virtual output program for a limit switch	Automatically generate the Shape Script to replicate the behavior of a limit switch in a specific mechanism.	
	Automatic program generation for Part Detection Sensor	Automatically generate the Shape Script to replicate the behavior of Part Detection Sensor detecting a virtual part.	
Behaviors Settings	Behaviors Settings	To move parts in Executing 3D Simulation, configures a 3D object behavior toward the parts.	
	Behaviors execution	Simulates parts based on Behaviors Settings.	
Executing 3D Simulation	Execution *1	Executes 3D Simulation	
	Collision detection	Detects a contact between 3D objects (e.g. equipment components, part) during operation.	

*1. 3D Simulation Option is required to operate the mechanical components in a 3D simulation.

3-7-26 Robot Function

The function is supported by the Sysmac Studio (64 bit) only.

Item		Description	Reference
Robot		---	Refer to the <i>Sysmac Studio Robot Integrated System Building Function with Robot Integrated CPU Unit Operation Manual (Cat. No. W595)</i> for details on functions.
Parameter Settings	EtherCAT Settings	You can register an Omron robot as an EtherCAT node.	
	Robot Common Settings	You can assign I/O that controlled with V+ program written in a robot control language.	
	Robot Basic Settings	You can assign robot numbers to robots.	
	Controller Settings	You can configure common settings for robot controllers.	
	Save Configuration	You can configure the setting to save V+ programs, V+ variables, and task settings at startup to the Controller's non-volatile memory (SD memory card).	
	Monitor Window	You can issue a control command directly to a robot system.	
	Robot Settings	You can configure settings for each robot.	
Programming	V+ Program Editor	You can register, edit, and debug V+ programs.	
	V+ Variables	You can register and edit V+ variables.	
	Search/Replace	Search/replace in V+ program.	
Communication	Online Connection	You can establish an online connection between PC and Controller.	
	Synchronization	You can compare data in the PC (project file) with that in the online-connected Robot Integrated CPU Unit to see differences in a list. Also, you can transfer the specified data all at once, together with Robot Controller Common Settings and V+ programs. It is possible to transfer an IEC program only with the transfer option.	
	Transfer All	You can transfer data between the online-connected Robot Integrated CPU Unit and PC. The data to be transferred is the same as that of Synchronization. Unlike Synchronization, data is transferred to the specified direction without showing comparison result. Robot Controller Common Settings and V+ programs are also transferred at the same time. It is possible to transfer an IEC program only with the transfer option.	
	V+ Program Synchronization	You can compare V+ programs and V+ variables in the PC (project file) with those in the online-connected Robot Integrated CPU Unit, and differences are shown in a list. You can specify data to transfer at once.	

Item		Description	Reference
Robot		---	Refer to the <i>Sysmac Studio Robot Integrated System Building Function with Robot Integrated CPU Unit Operation Manual (Cat. No. W595)</i> for details on functions.
Communi- cation	Push to V+ Memory	You can transfer all V+ programs and V+ variables in the PC (project file) and online-connected Robot Integrated CPU Unit from PC to Controller at the same time.	
	Pull from V+ Memory	You can transfer all V+ programs and V+ variables in the PC (project file) and online-connected Robot Integrated CPU Unit from Controller to PC at the same time.	
Project Manage- ment	Open in Emu- lation Mode	Select this option before opening the project to configure Robot Control Function Module, edit V+ program and do offline debugging.	
	Enable Emu- lation Mode	You can enable the emulation mode and reopen the project.	
	Disable Emu- lation Mode	You can disable the emulation mode and reopen the project.	
	Print	You can print V+ programs, V+ variables, robot settings, and others.	
	Application Sample	You can create a sample of Pack manager or Robot Vision Manager as a project of Application Manager device, based on a robot configuration created by EtherCAT Editor. You can specify the version of an Application Manager device.	
Debug- ging	3D Visualizer	You can check or change the robot's position. During a simulation, you can check movements of the robot.	
	Task Status Control	This user interface enables an online connection to Robot Control Function Module, robot's power state control, monitor speed setting, and activation of other debugging functions.	
	Task Manager	You can allocate V+ program to a task managed by Robot Control Function Module to control execution of the program.	
	IO Watcher	You can monitor robot's digital I/O in a list.	
	Virtual Front Panel	You can monitor robot's mode, power state, and emergency stop button state. This function is available in the emulation mode.	
	V+ Jog Con- trol	You can determine a position of the selected robot checking the 3D Visualizer. Position of the robot's tip is to be registered to a location variable.	
Informa- tion Mon- itoring	Troubleshoot- ing/Event Log	You can check errors in the Controller, instruct countermeasures, clear errors, or confirm it.	
	System Moni- tor	You can monitor robot's parameters in real time.	
	eV+ Log	You can display processing history of Robot Control Function Modules.	

Item		Description	Reference
Robot		---	Refer to the <i>Sysmac Studio Robot Integrated System Building Function with Robot Integrated CPU Unit Operation Manual (Cat. No. W595)</i> for details on functions.
Maintenance	Hardware Diagnostics	You can check robot's motor status.	
	Data Collection	You can display or save the robot system data.	
	Motor Tuning	You can send a square wave signal positioning command to the specified motor to monitor its response.	
	V+ Version Setting	You can update configured V+ versions of the online-connecting Controller and robot to an operable combination.	
Security	Robot System Operation Authentication	This function prevents illegal changes in Robot Control Function Module settings or V+ program editing both online and offline.	
Customization	V+ Program	You can define headers generated when creating a new V+ program, configure intelligences, etc.	

3-7-27 Application Manager Function

The function is supported by the Sysmac Studio (64 bit) only.

Item		Description	Reference
Application Manager		---	Refer to the <i>Sysmac Studio Robot Integrated System Building Function with IPC Application Controller Operation Manual (Cat. No. W621)</i> for details on functions.
Setting	IP Address	You can set Application Controller's IP address.	
	Port Number	You can set the port numbers of Application Manager running on the Application Controller.	
3D Visualization Object	CAD Data	You can add CAD data.	
	Cylinder	You can add cylinders.	
	Box	You can add boxes.	
	Mechanical Component*1	You can add mechanical components controlled by I/O or motion axes.	
	Virtual Part Detection Sensor	You can add virtual sensors that detect position of the part.	
	Custom Mechanics	Adds custom mechanics that any movable parts can be configured.	
	Parallel Link Mode	Adds a parallel link model.	
	Batch Export 3D Visualization Objects	You can export multiple 3D Visualization Objects in a project to a file.	
Import 3D Visualization Object	You can import a file containing exported 3D Visualization Objects to a project.		
Robot Vision Manager	Belt Latch Calibration	You can calibrate the positional relation between the robot and latch.	
	Belt Calibration	You can calibrate the positional relation between the robot and conveyor belt.	
	Camera Calibration	You can calibrate the positional relation between the robot and camera.	
	Gripper Offset Table	You can define where on the part the robot can pick it and flange-centered relationship among pick spot, part model, and robot.	
	Vision Sequence	You can display the order and dependency of vision tools to be executed.	
	Overlap Tool	This function makes the part moving on the conveyor belt processed only once, even if it appears in multiple images.	
	Communication Tool	You can configure settings for sending results of image sensing associated with the belt to the Controller's queue to make the robot process them.	

Item		Description	Reference
Application Manager		---	Refer to the <i>Sysmac Studio Robot Integrated System Building Function with IPC Application Controller Operation Manual (Cat. No. W621)</i> for details on functions.
Camera Settings	Virtual Camera	You can set a virtual camera that vision tools reference. During simulation, the emulation camera is used, but in the real machine, it switches to the Basler camera.	
	Emulation Camera	You can emulate saved images as if taken by a camera.	
	Basler Camera	You can configure settings to use the Basler camera.	
	Sentech Camera	You can configure settings to use the Sentech camera.	
	Custom Device	Using C# programs, you can acquire images from any camera device or external vision system.	
	Virtual Capture Device	Assigning the image data captured as 3D shape data in the 3D Visualizer to a virtual camera allows you to handle it as if the data were captured with a physical camera.	
Configuration	Controller Connection Startup	You can connect Application Manager running on the Application Controller to the Robot Integrated CPU Unit and configure settings to instruct controls, at a startup of Application Manager.	
	Data Mapper	Function that allows changes in the state of robot I/O or other to be assigned to other robot I/O or other process state changes.	
	Note	You can create text documents.	
	OPC Container	You can set an OPC container to communicate data with an external PC.	
	Program System Startup	You can specify C# program which run automatically when an Application Manager project running on the Application Controller is opened.	
	Recipe Manager	This function enables batch management of initial values of V+ variables, vision tools, cameras, and others, according to the objects handled by equipment. You can switch CAD data using Recipe Manager.	
	Recipe Manager Script	You can manage recipes with C# script.	
Feeders	AnyFeeder	You can configure settings to use AnyFeeder.	
	IO Feeder	You can configure settings to use a general feeder.	

Item		Description	Reference
Application Manager		---	Refer to the <i>Sysmac Studio Robot Integrated System Building Function with IPC Application Controller Operation Manual (Cat. No. W621)</i> for details on functions.
Process	Part Buffer	You can set a location where the part is temporarily stored if the target cannot be used to accept the part.	
	Part Target	You can configure settings of a part that the robot places, which handled in Process Manager.	
	Part	You can configure settings of a part that the robot picks, which handled in Process Manager.	
	Belt	You can configure a conveyor belt.	
	Process Manager	You can manage allocations and control queuing of multiple controllers, robots, conveyors, parts, and targets.	
	Allocation Script	You can create Custom Part Allocation Program used in Process Manager with C#.	
	Pallet	It is the base object to pick and place multiple parts.	
	Vision Refinement Station	With this function, you can configure position of upward-facing camera in order to adjust orientations of the part and gripper.	
Vision	Finder	This function creates a vectorized depiction of an object or object function and usually returns a result by coordinate.	
	Inspection	By identifying pixel information, you can check the various aspects of the detected objects or features, such as color deviations, defects, and product density.	
	Reader	You can acquire character string data from characters in code or image.	
	Calculation	You can create new entity in an image based on user-defined or existing entities.	
	Image Process	This function provides helpful operations and features to analyze and process images.	
	Custom	You can directly control processing methods for images and tools.	
Programs	C# Program	You can reference and compute the data handled by Application Manager with C# program to create an application.	
	Variables	You can define a variable in the Variables section in Multiview Explorer when you need a variable shared with multiple C# programs.	
	Search/Replace	Search/replace in C# program.	
Communication	Online Connection	You can establish an online connection between PC and Application Manager on the Application Controller.	
	Synchronization	You can compare data in the PC (project file) with that in the online-connected Application Manager to see differences in a list. Also, you can transfer the specified data all at once. The option that omits 3D Shape Data from the transfer reduces the transfer time.	

Item		Description	Reference
Application Manager		---	Refer to the <i>Sysmac Studio Robot Integrated System Building Function with IPC Application Controller Operation Manual (Cat. No. W621)</i> for details on functions.
Project Management	Open in Emulation Mode	Select this option before opening the project to configure Application Manager, Robot Control Function Module, edit V+ program and do offline debugging.	
	Enable Emulation Mode	You can enable the emulation mode and reopen the project.	
	Disable Emulation Mode	You can disable the emulation mode and reopen the project.	
	Print	You can print settings of Application Manager and programs.	
Debugging	3D Visualizer	You can check or change position of the robot, belt, or other objects. During a simulation, you can check movements of the robot and parts.	
	Task Status Control	You can monitor and control Process manager of Application Manager and execution of C# program. This user interface enables an online connection to Robot Control Function Module, robot's power state control, monitor speed setting, and activation of other debugging functions.	
	Task Manager	You can allocate V+ program to a task managed by Robot Control Function Module to control execution of the program.	
	IO Watcher	You can monitor robot's digital I/O in a list.	
	Virtual Front Panel	You can monitor robot's mode, power state, and emergency stop button state. This function is available in the emulation mode.	
	V+ Jog Control	You can determine a position of the selected robot checking the 3D Visualizer. Position of the robot's tip is to be registered to a location variable.	
Information Monitoring	System Monitor	You can monitor Process Manager of Application Manager, execution status of C# program, and robot's parameters in real time.	
Security	Robot System Operation Authentication	This function prevents illegal changes in Application Manager Settings both online and offline.	

*1. 3D Simulation Option is required to operate mechanical components during 3D simulation.

3-7-28 Automation Playback Function

Item		Description	Reference
Setting Parameters		---	Refer to the <i>NX-series CPU Unit Automation Playback User's Manual (Cat. No. W639)</i> for details on functions.
Operation Settings	Automation Playback Settings	Basic settings of Automation Playback regarding variable data collection are configured. Also you can set the variable data to collect and the method to output variable data to a variable log.	
Monitoring	Automation Playback Operation Monitor	You can check the operation status of Automation Playback. Automation Playback Operation Monitor shows the sampling time margin, sampling status, etc.	
Automation Playback		---	
	Playback	You can play, stop, and perform backward/forward playback data. Playback data is played so that the play operation of the playback data is synchronized with the monitor display of the ladder or ST program and the Watch tab page.	
	Playback Chart	You can display changes in variable values during playback in a graph, and play the video. You can also compare their waveforms with those of other playback data.	
	Video Playback Window	Video Playback Window plays video data. You can play the data in synchronization with playback data.	
	Search Playback Data	You can search for playback data by specifying variable search conditions, such as the rising edge of a variable. You can jump to the timing when a device variable changes and check the behavior of the device.	

4

Programming

This section describes how to create programs with the Sysmac Studio.

4-1	Variable Registration	4-3
4-1-1	Creating Global Variables	4-4
4-1-2	Creating Device Variables	4-11
4-1-3	Creating Local Variables	4-22
4-1-4	Creating Axis Variables	4-27
4-1-5	Creating Axes Group Variables	4-30
4-1-6	Creating Cam Data Variables	4-32
4-1-7	Creating Function Block Instance Variables	4-35
4-1-8	System-defined Variables	4-36
4-1-9	Entering Variable Attributes	4-36
4-1-10	Variable Manager	4-48
4-2	Registering POUs	4-57
4-2-1	Displaying POUs	4-57
4-2-2	Registering Programs	4-57
4-2-3	Registering Function Blocks	4-60
4-2-4	Registering Functions	4-62
4-2-5	Copying, Pasting, and Deleting Multiple POUs	4-64
4-3	Creating Data Types	4-69
4-4	Namespaces	4-79
4-4-1	Data for Which You Can Use Namespaces	4-79
4-4-2	Setting Namespaces	4-79
4-4-3	Using Namespaces	4-82
4-5	Programming Ladder Diagrams	4-85
4-5-1	Opening and Using the Ladder Editor	4-85
4-5-2	Adding and Deleting Sections	4-86
4-5-3	Basic Ladder Editor Operations	4-90
4-5-4	Editing Variables and Data Types in the Ladder Editor	4-112
4-5-5	Operating Functions and Function Blocks in the Ladder Editor	4-117
4-5-6	Element Comments and Rung Comments	4-135
4-5-7	Inserting and Deleting Jump Labels and Jumps	4-138
4-5-8	Customizing the View	4-141
4-5-9	Ladder Editor Guide	4-142
4-5-10	Ladder Editor Shortcut Key List	4-145
4-5-11	Rung Pattern Copy	4-146
4-6	Programming Structured Text	4-152
4-6-1	Starting the ST Editor	4-152
4-6-2	Basic ST Editor Operations	4-153

4-6-3	Editing Variables and Data Types in the ST Editor.....	4-158
4-6-4	Operating Functions and Function Blocks in the ST Editor.....	4-162
4-6-5	Customizing the View.....	4-165
4-7	Comparison before Pasting Dependents.....	4-166
4-7-1	Comparison before Pasting Dependents Dialog Box.....	4-166
4-7-2	Detailed Comparison Window.....	4-167
4-8	Searching and Replacing.....	4-168
4-8-1	Scope of Searching and Replacing.....	4-168
4-8-2	Search and Replace Pane.....	4-168
4-8-3	Items to Set.....	4-169
4-8-4	Searching.....	4-172
4-8-5	Replacing.....	4-173
4-8-6	Searching All.....	4-174
4-8-7	Replacing All.....	4-174
4-8-8	Replacing All N.O. and N.C. Inputs.....	4-174
4-9	Program Checks.....	4-175
4-9-1	Check All Programs.....	4-175
4-9-2	Check Selected Programs.....	4-175
4-10	Building and Rebuilding.....	4-178
4-11	Offline Comparison.....	4-180
4-11-1	Procedure for Offline Comparison.....	4-180
4-11-2	Printing Offline Comparison Results.....	4-184
4-11-3	Merging Detailed Comparison Results.....	4-187

4-1 Variable Registration

- Variable Registration

You can create variables to hold the data that is used in the control algorithms in the NJ/NX/NY-series Controller. You can define the following types of variables.

Variable type	Description
Global variables	<p>You can read and write global variables from any POU (program, function, or function block). You declare global variables in the global variable table. You use global variables to interface different POUs.</p> <p>You can read and write a global variable from any POU that is executed on the CPU Unit where the global variable was declared. However, a POU that runs on another CPU Unit cannot access these variables.</p> <p><i>Device variables</i> that are automatically generated from the Unit configuration and slave configuration are automatically registered as global variables. The <i>Axis Variables and Axes Group Variables</i> that are automatically generated from the axes and axes groups are also automatically registered as global variables.</p>
Device variables	<p>A device variable is used to access data in a device (i.e., slave or Unit). The data is accessed through logical interface ports that are called <i>I/O ports</i>. You assign device variables to the <i>I/O ports</i> that are automatically created when you create the EtherCAT slave configuration information or the Unit configuration information in the <i>I/O Map</i> of the Sysmac Studio.</p>
Local variables	<p>A local variable can be used only within one POU. A local variable is declared in the local variable table for the POU. You cannot access the values of local variables from outside of the POU. Even if you declare a local variable with the same name in a different POU, those variables do not share the same memory space.</p>
Axis Variables	<p>Axis Variables are system-defined variables. They are structures that provide information on axes (such as physical quantities, status, and error information). They are used to access EtherCAT slaves that are assigned to an <i>axis</i>.</p>
Axes Group Variables	<p>Axes Group Variables are structures for axes groups. An <i>axes group</i> contains multiple <i>axes</i> that are interpolated. Axes Group Variables are used for interpolated motions in programs.</p>
Cam data variables	<p>You use these variables to access cam data. You create them in the Cam Data Settings in the Sysmac Studio. A cam data variable is a structure array variable that consists of phases and displacements.</p>
Function block instance variables	<p>Function block instance variables are names that are assigned to function block instances so that you can manage the function block instances individually.</p> <p>A function block that has a given name and can retain internal variables is called a <i>function block instance</i>. Instances of function blocks are automatically registered as local variables. Specify the instance variable name when you call a function block from another POU.</p>
Derivative variables (structures, unions, and enumerations)	<p>Derivative variables have user-defined data types. They group together variables of different data types into a single variable. You can give any name to the data type.</p> <p>You must specify the variable name that uses the user-defined data type and at least one <i>member</i> in that variable.</p>
System-defined variables	<p>System-defined variables are provided in advance in an NJ/NX/NY-series Controller. The variables and all attributes are defined by the system. They have specific functions. System-defined variables are supplied for each function module.</p> <p>You cannot change the variable names or any other attributes.</p>

4-1-1 Creating Global Variables

- Creating Global Variables

You can create variables that you can access from different POUs (programs, functions, or function blocks).

The device variables that are used to access slave and Unit data, such as EtherCAT slave and CJ-series Unit device variables, are also registered as global variables.

- **Opening the Global Variable Tab Page**

Double-click **Global Variables** under **Programming - Data** in the Multiview Explorer. Or, right-click **Global Variables** under **Programming - Data** and select **Edit** from the menu.

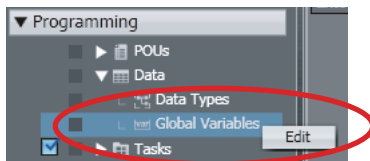

The global variable table is displayed.

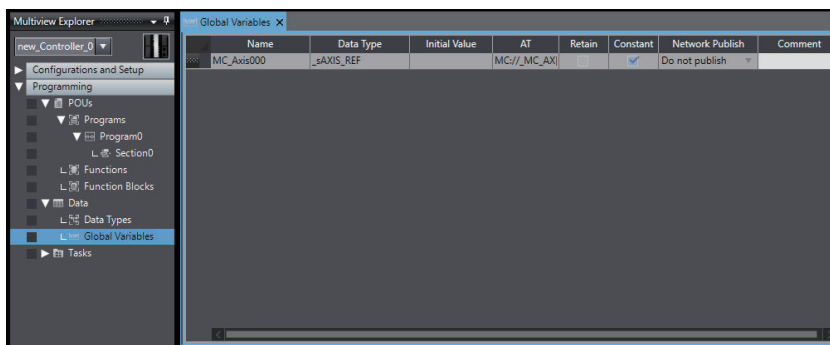

- **Creating Global Variables**

- 1 Press the Insert Key in the global variable table, or right-click in the global variable table and select **Create New** from the menu.

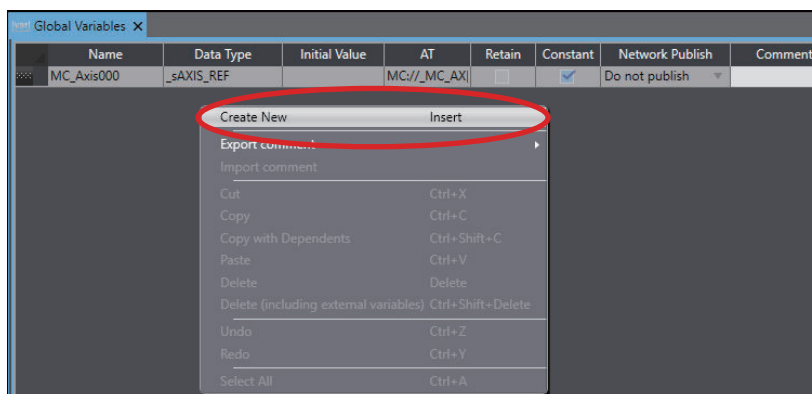

- 2 Enter values for each item, and then press the Enter Key.

Name	Data Type	Initial Value	AT	Retain	Constant	Network Publish	Comment
MC_Axis000	_sAXIS_REF		MC://_MC_AXI	<input type="checkbox"/>	<input checked="" type="checkbox"/>	Do not publish	
test	_sAXIS_REF			<input type="checkbox"/>	<input type="checkbox"/>	Do not publish	

The variable is registered. Always set the variable name and the data type.

Refer to 4-1-9 *Entering Variable Attributes* on page 4-36 for information on entering values for attributes.

● Editing Global Variables

- 1 Click the cell to edit for the variable.

Name	Data Type	Initial Value	AT	Retain	Constant	Network Publish	Comment
MC_Axis000	_sAXIS_REF		MC://_MC_AXI	<input type="checkbox"/>	<input checked="" type="checkbox"/>	Do not publish	
test				<input type="checkbox"/>	<input type="checkbox"/>	Do not publish	

For the Data Type cell, if you press the Ctrl + Space Keys or enter the first character of the data type, a drop-down list is displayed.

- 2 Change the setting, and then press the Enter Key.
The change is applied to the variable.

Name	Data Type	Initial Value	AT	Retain	Constant	Network Publish	Comment
MC_Axis000	_sAXIS_REF		MC://_MC_AXI	<input type="checkbox"/>	<input checked="" type="checkbox"/>	Do not publish	
test	INT			<input type="checkbox"/>	<input type="checkbox"/>	Do not publish	

● Deleting Variables

- 1 Click the header on the row of the variable to delete to select the entire row.

Name	Data Type	Initial Value	AT	Retain	Constant	Network Publish	Comment
MC_Axis000	_sAXIS_REF		MC://_MC_AXI	<input type="checkbox"/>	<input checked="" type="checkbox"/>	Do not publish	
delete_test	BOOL			<input type="checkbox"/>	<input type="checkbox"/>	Do not publish	
test	INT			<input type="checkbox"/>	<input type="checkbox"/>	Do not publish	

- 2 Press the Delete Key. Or, right-click a row and select **Delete** from the menu. To delete a global variable together with external variables that refer to the global variable, press the Ctrl + Shift + Delete Keys, or select **Delete (including external variables)** from the pop-up menu.

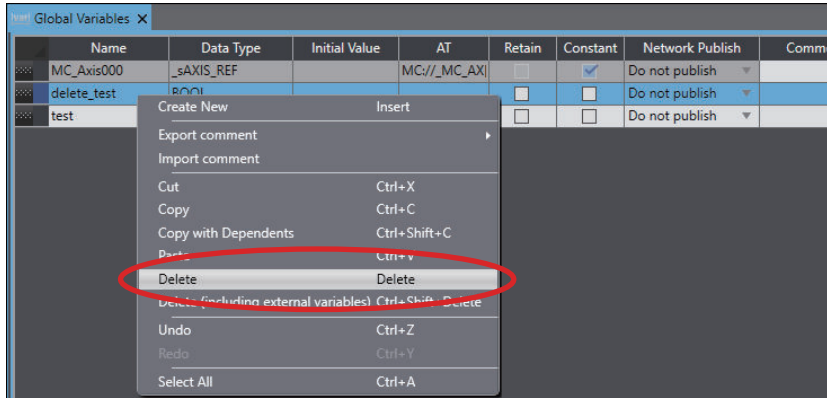

The variable is deleted.

If you select **Delete (including external variables)**, all external variables that refer to the global variable will be deleted.

● Copying and Pasting Cells

- 1 Click any cell.
- 2 Press the Ctrl + C Keys. Or, right-click and select **Copy** from the menu.
- 3 Press the Ctrl + V Keys for the cell to which you want to paste the data. Or, right-click and select **Paste** from the menu.
The copied data is pasted to the target cell.

● Copying and Pasting Variables

There are the following menus to copy variables.

- **Copy**: Only variables are copied.
- **Copy with Dependents**: Not only variables but also data type definitions of the variables are copied.

- 1 Click the header on the row of the variable to copy to select the entire row.

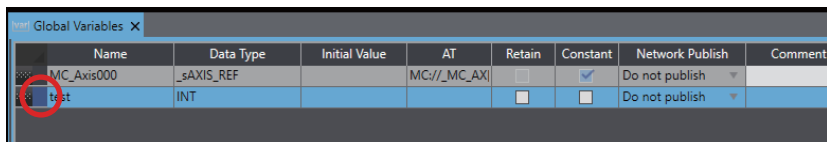

- 2 Press the Ctrl + C Keys. Or, right-click the row and select **Copy** from the menu. If you want to copy data together with the data type definitions of variables, select **Copy with Dependents**.

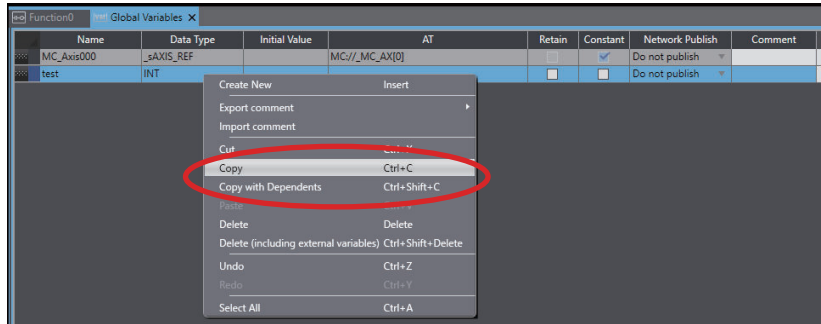

The specified variable is copied.

- 3** Press the Ctrl + V Keys in the destination variable table. Or, right-click and select **Paste** from the menu.

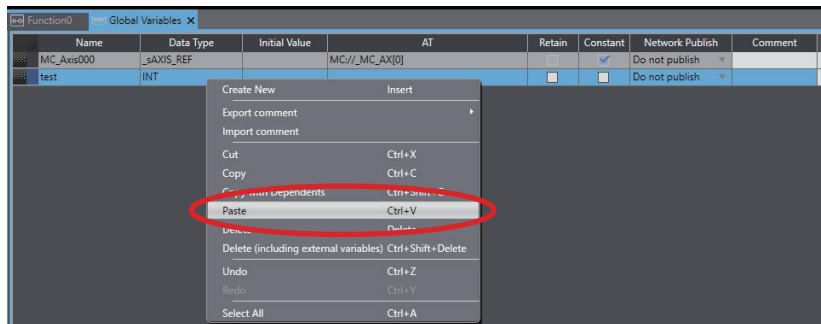

- When **Copy** is selected

A copy of the variable is registered with **_Copy** added to the name of the variable that was copied.

Name	Data Type	Initial Value	AT	Retain	Constant	Network Publish	Comment
MC_Axis000	_sAXIS_REF		MC//_MC_AXI[0]	<input type="checkbox"/>	<input checked="" type="checkbox"/>	Do not publish	
test	INT			<input type="checkbox"/>	<input type="checkbox"/>	Do not publish	
test_Copy	INT			<input type="checkbox"/>	<input type="checkbox"/>	Do not publish	

- When **Copy with Dependents** is selected

Not only variables but also data type definitions of the variables are pasted. If a data type definition with the same name and different attribute already exists in the destination, the **Comparison before pasting dependents** Dialog Box is displayed.

For details on the **Comparison before pasting dependents** Dialog Box, refer to *4-7 Comparison before Pasting Dependents* on page 4-166.



Precautions for Correct Use

If you enter any invalid characters or out of range values, the cell is highlighted in red. An error will occur when the program is checked. For information on restrictions on variable names, refer to the *NJ/NX-series CPU Unit Software User's Manual (Cat. No. W501)* or *NY-series Industrial Panel PC / Industrial Box PC Software User's Manual (Cat. No. W558)*.

Name	Data Type	Initial Value	AT	Retain	Constant	Network Publish	Comment
MC_Axis000	_sAXIS_REF		MC//_MC_AXI	<input type="checkbox"/>	<input checked="" type="checkbox"/>	Do not publish ▼	
test	INT			<input type="checkbox"/>	<input type="checkbox"/>	Do not publish ▼	
test_Copy	INT	1.0		<input type="checkbox"/>	<input type="checkbox"/>	Do not publish ▼	



Additional Information

- If no variables are registered, *There are no variables in the table. Click here to add.* is displayed. Click to add a new variable.
- A global variable is registered automatically when you perform any of the following operations.
 - a) When you enter a new variable in the **Variable** Column of the I/O Map with *Global Variable* specified in the **Variable Type** Column.
 - b) When you create a new interface variable between tasks.
 - c) When you create a new axis, axes group, cam, or cam definition in the Multiview Explorer.
- You can register new variables that are entered into the Ladder Editor or ST Editor as global variables. Select the **Select the local or global variable and register it** Check Box in the option settings to select the location in which variables are registered. Then, specify **Global** as the variable type when you enter the variables. Refer to *8-26 Sysmac Studio Option Settings* on page 8-166 for details on the option settings.
- When you change the name of a registered global variable, you can also change at the same time the name of the same variable where it is used in programs or external variables. Set the *Change the variable name used in programs* Check Box in the option settings. Refer to *8-26 Sysmac Studio Option Settings* on page 8-166 for details.
- If the same variable names exist when variables are copied and pasted from other variable tables or spreadsheets, a dialog box that lists the source and destination variables is displayed. Select the variable to overwrite and execute the paste.
- If an NA-series PT is registered in the project, you can drag variables from the global variable table to the NA-series PT Page Editor to add them as objects. Refer to the *NA-series Programmable Terminal Software User's Manual (Cat. No. V118)* for details.

● Selecting Rows

Click the header on the row, and the entire row is selected.

Name	Data Type	Initial Value	AT	Retain	Constant	Network Publish
PB1	BOOL			<input type="checkbox"/>	<input type="checkbox"/>	Do not publish ▼
PB2	BOOL			<input type="checkbox"/>	<input type="checkbox"/>	Do not publish ▼
PB3	BOOL			<input type="checkbox"/>	<input type="checkbox"/>	Do not publish ▼
CON_Line1	BOOL			<input type="checkbox"/>	<input type="checkbox"/>	Do not publish ▼
CON_Line2	BOOL			<input type="checkbox"/>	<input type="checkbox"/>	Do not publish ▼
CON_Line3	BOOL			<input type="checkbox"/>	<input type="checkbox"/>	Do not publish ▼

Hold down the Ctrl or Shift Key and click the headers of rows to select more than one row.

● Moving Rows

You can drag and drop the grip at the left end of the row to change the order of the rows.

	Name	Data Type	Initial Value	AT	Retain	Constant	Network Publish
	PB1	BOOL			<input type="checkbox"/>	<input type="checkbox"/>	Do not publish ▾
	PB2	BOOL			<input type="checkbox"/>	<input type="checkbox"/>	Do not publish ▾
	PB3	BOOL			<input type="checkbox"/>	<input type="checkbox"/>	Do not publish ▾
	CON_Line1	BOOL			<input type="checkbox"/>	<input type="checkbox"/>	Do not publish ▾

● Sorting Global Variables

You can sort the global variable table in ascending or descending order according to any column.

- 1 Click the title row cell for the column to use to sort the variable table.

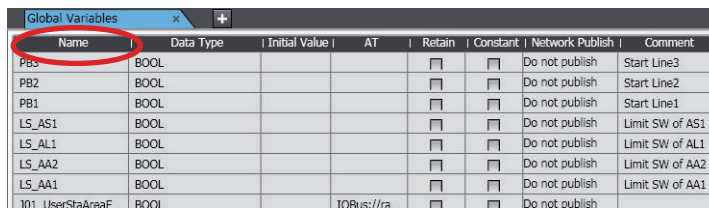

Name	Data Type	Initial Value	AT	Retain	Constant	Network Publish	Comment
PB3	BOOL			<input type="checkbox"/>	<input type="checkbox"/>	Do not publish	Start Line3
PB2	BOOL			<input type="checkbox"/>	<input type="checkbox"/>	Do not publish	Start Line2
PB1	BOOL			<input type="checkbox"/>	<input type="checkbox"/>	Do not publish	Start Line1
LS_AS1	BOOL			<input type="checkbox"/>	<input type="checkbox"/>	Do not publish	Limit SW of AS1
LS_AL1	BOOL			<input type="checkbox"/>	<input type="checkbox"/>	Do not publish	Limit SW of AL1
LS_AA2	BOOL			<input type="checkbox"/>	<input type="checkbox"/>	Do not publish	Limit SW of AA2
LS_AA1	BOOL			<input type="checkbox"/>	<input type="checkbox"/>	Do not publish	Limit SW of AA1
J01_UserStaAreaE...	BOOL		IOBus://ra...	<input type="checkbox"/>	<input type="checkbox"/>	Do not publish	

A sort icon is displayed in the title row and the relative column is sorted in ascending order.

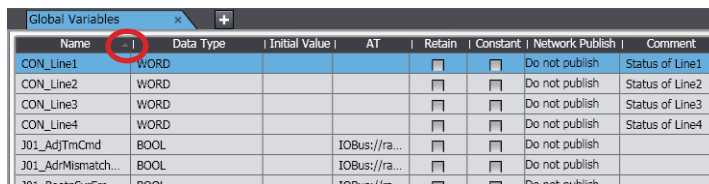

Name	Data Type	Initial Value	AT	Retain	Constant	Network Publish	Comment
CON_Line1	WORD			<input type="checkbox"/>	<input type="checkbox"/>	Do not publish	Status of Line1
CON_Line2	WORD			<input type="checkbox"/>	<input type="checkbox"/>	Do not publish	Status of Line2
CON_Line3	WORD			<input type="checkbox"/>	<input type="checkbox"/>	Do not publish	Status of Line3
CON_Line4	WORD			<input type="checkbox"/>	<input type="checkbox"/>	Do not publish	Status of Line4
J01_AdjTmCmd	BOOL		IOBus://ra...	<input type="checkbox"/>	<input type="checkbox"/>	Do not publish	
J01_AdrMismatch...	BOOL		IOBus://ra...	<input type="checkbox"/>	<input type="checkbox"/>	Do not publish	
J01_RontrSurFer	BOOL		IOBus://ra...	<input type="checkbox"/>	<input type="checkbox"/>	Do not publish	

Click the cell in the title row again to sort the table in descending order.

- 2 To cancel sorting, right-click the title row cell for the column that you used to sort the variable table and select **Clear Sorting**.



Additional Information

The sorting results are lost when you close the global variable table.

● Filtering Global Variables

You can apply a filter to the variable table to display only specific variables.

- 1 Right-click the title row cell for the column to use to filter the variable table and select **Filtering**.

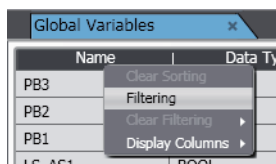

Name	Data Ty
PB3	
PB2	
PB1	
LS_AS1	BOOL

The Filtering Dialog Box is displayed.

The contents of the dialog box depends on the column that is selected.

The following example is for the variable name.

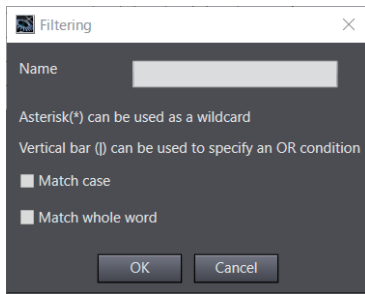

- 2 Enter the text string and condition to use for filtering in the Filtering Dialog Box, and click the **OK** Button.

An icon that indicates filtering is active appears in the title row and only the variables that meet the specified condition are displayed.

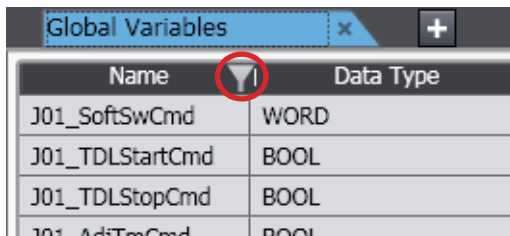

- 3 To cancel filtering, right-click the title row cell for the column that you used to filter the variable list and select **Clear Filtering – Selected Column** or **All Columns**.



Additional Information

- You can apply filtering to more than one column to restrict the variables that are displayed even further.
- The filtering results are lost when you close the global variable table.
- If you copy variables while a filter is active, the variables that are hidden will not be copied.

● Showing and Hiding Columns

You can show and hide columns in the variable table.

- 1 Right-click the title row cell for the desired column and select **Display Columns**. A list of the displayed columns is displayed.

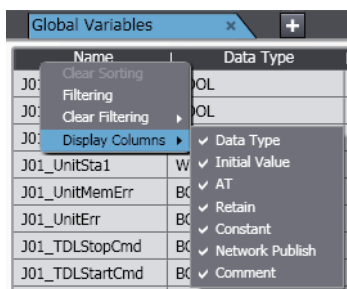

All columns are selected by default.

- 2 Clear the selections of the columns to hide.

The columns are hidden.

4-1-2 Creating Device Variables

- Device Variables

A device variable is used to access data in a device (i.e., slave or Unit).

This data is accessed through a port that acts as an interface to an external device. This logical port is called an *I/O port*.

Creating Variables

You can create device variables in the I/O Map.

You can either automatically create a device variable or manually enter the device variable name to create it.

- **Manually Entering a Device Variable Name**

You can enter a device variable name manually.

You create device variables with this method in the following cases.

- To assign your own name for a slave I/O Terminal or a Basic I/O Unit.

- 1 Create the slave configuration information or Unit configuration information.
- 2 Select an I/O port in the I/O Map and enter a variable in the *Variable* Column.
To specify a variable table for the variable type, specify the variable type in advance.

Port	Description	R/W	Data Type	Variable
CF	CPU/Expansion Racks			
	CPU Rack 0			
[0]	CJ1W-OD232 (Transistor Output)			
	Ch1_Out			
	Ch1_Out00	RW	WORD	sample001
	Ch1_Out01	RW	BOOL	
	Ch1_Out02	RW	BOOL	

Device variables are automatically assigned to the I/O ports for each slave or Unit. These device variables are also automatically registered in the variable table specified in the **Variable Type** Column.

- **Automatically Creating Device Variables**

The device variables are named automatically from a combination of the device names or any strings and the I/O port names.

Menu	Description
Create Device Variable	The variables are named automatically from a combination of the device names and the I/O port names.
Create Device Variable with Prefix	The variables are named automatically from a combination of any prefixes or suffixes and the I/O port names. When None is selected, the variables with the I/O port names are generated automatically.

You create device variables with this method in the following cases.

- To eliminate the work that is involved in obtaining the device variable names.

- To automatically create device variables to use to access operating data and setup data for CJ-series Special Units.

- 1 Create the slave configuration information or Unit configuration information.
- 2 For each device whose name you can change, set a device name in the Edit Pane.

Item name	Value
Device name	J01
Model name	CJ1W-OD232
Product name	Transistor Output Unit
Specifications	24V DC, 0.5A, 32 sourcing out...
Rack No.	0
Slot No.	0

The default device names are as follows:

- For X Bus Units, the default device names start with an *X* followed by a *sequential number starting from 1*.
- For NX Units, the default device names start with an *N* followed by a *sequential number starting from 1*.
- For slaves, the default device names start with an *E* followed by a *sequential number starting from 001*.
- For CJ-series Units, the default device names start with a *J* followed by a *sequential number starting from 01*.

- 3 Select a slave, Unit, or one or more I/O ports in the I/O Map, right-click, and then select **Create Device Variable** or **Create Device Variable with Prefix** from the menu.

To specify a variable table for the variable type, specify the variable type in advance.

When you select **Create Device Variable with Prefix**, specify Prefix, Suffix, or None in the next dialog box.

Position	Port	Description	R/W	Data Type	Variable	Variable Comment	Variable Type
	EtherCAT Network Configuration						
	CPU/Expansion Racks						
	CPU Rack 0						
[00]	CJ1W-ID262 (DC Input Unit)						
	Ch1_In	Input CH1	R	WORD			
	Ch1_In00	Input CH1 bit 00	R	BOOL			
	Ch1_In01	Input CH1 bit 01	R	BOOL			
	Ch1_In02	Input CH1 bit 02	R	BOOL			
	Ch1_In03	Input CH1 bit 03	R	BOOL			
	Ch1_In04	Input CH1 bit 04	R	BOOL			
	Ch1_In05	Input CH1 bit 05	R	BOOL			
	Ch1_In06	Input CH1 bit 06	R	BOOL			
	Ch1_In07	Input CH1 bit 07	R	BOOL			
	Ch1_In08	Input CH1 bit 08	R	BOOL			
	Ch1_In09	Input CH1 bit 09	R	BOOL			
	Ch1_In10	Input CH1 bit 10	R	BOOL			
	Ch1_In11	Input CH1 bit 11	R	BOOL			
	Ch1_In12	Input CH1 bit 12	R	BOOL			
	Ch1_In13	Input CH1 bit 13	R	BOOL			
	Ch1_In14	Input CH1 bit 14	R	BOOL			
	Ch1_In15	Input CH1 bit 15	R	BOOL			
	Ch2_In	Input CH2	R	WORD			
	Ch3_In	Input CH3	R	WORD			
	Ch4_In	Input CH4	R	WORD			

Device variables are automatically assigned to the I/O ports for each slave or Unit. These device variables are also automatically registered in the variable table specified in the **Variable Type** Column.



Precautions for Correct Use

When you use an instruction with a *UnitProxy* input variable for a Unit on an NX-series Slave Terminal, perform the following operation.

1. Right-click the Unit and select **Display Node Location Port** from the menu. The **Node Location Information** row is displayed in the table.
2. Set a device variable.



Additional Information

- We recommend that you set the device names.
 - If you do not specify anything in the **Variable Type** Column when you register a variable or create device variables, the variables are automatically registered in the global variable table.
- Example of Creating Device Variables

The variable is created from the user-defined slave or Unit name and the selected I/O port name.

Registered slave or Unit	Device variable notation		Description	Variable name
	Slave or Unit name	I/O port name		
NX-ID3344	N1	Input Bit 00	---	N1_Input_Bit_00
GX-ID1611	E001	Bit00	---	E001_Bit00
GX-AD0471	E002	CH0 input 16-bit	---	E002_CH0_input_16-bit
CJ1W-ID212	J01	Ch1_In00	Bit 00 on input word 1	J01_Ch1_In00
CJ1WAD041-V1	J02	Ch1_PkHdCmd	Holds peak value for input 1.	J02_Ch1_PkHdCmd

● Selecting from the Registered Variables

You can select variables that are already registered on the I/O Map.

You create device variables with this method in the following cases.

- To program before you create the slave configuration information or Unit configuration information.
- To reuse programs from another project.

Use the following procedure.

- 1** Register the variables in advance in the global variable table.
- 2** Program using those variables.
- 3** Create the slave configuration information or Unit configuration information.
- 4** Select a variable from a pull-down list in the I/O Map View to assign it to an I/O port.

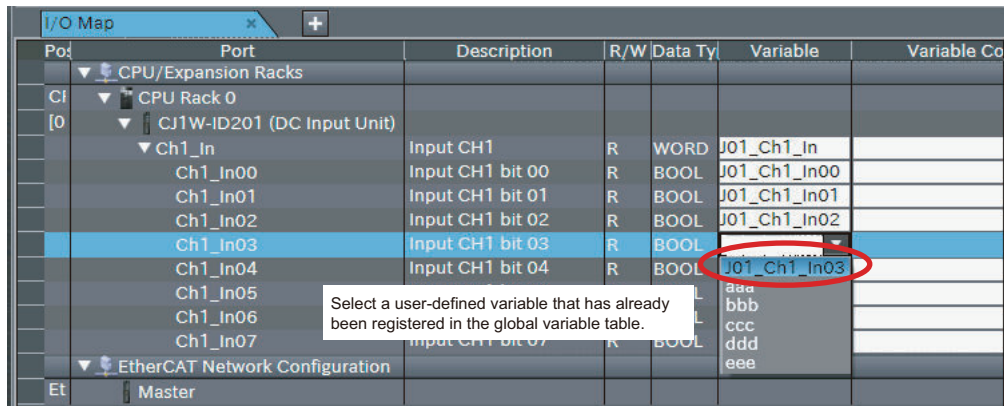

Additional Information

To remove the variable assigned to an I/O port, clear the *Variable* Column or right-click the variable and select **Reset Assignment** from the menu.

The device variable assignment is removed. However, removing the assignment does not delete the variable from the variable table where it is registered.

● Device Variable Attributes

Device variables are registered in the variable table specified in the *Variable Type* Column under the following conditions.

Attribute	Setting	Changes to settings
Name	<p>Automatically generated variables: [device_name] + [I/O_port_name]</p> <p>The default device names are as follows:</p> <ul style="list-style-type: none"> For X Bus Units, the device names start with an <i>X</i> followed by a <i>sequential number starting from 1</i>. For NX Units, the device names start with an <i>N</i> followed by a <i>sequential number starting from 1</i>. For CJ-series Units, the device names start with a <i>J</i> followed by a <i>sequential number starting from 01</i>. For EtherCAT slaves, the device names start with an <i>E</i> followed by a <i>sequential number starting from 001</i>. For the built-in I/O port^{*1}, the device names are fixed to <i>BIO</i>. For Option Boards^{*1}, the device names are fixed to <i>OP1</i> or <i>OP2</i>. <p>Refer to 4-1-2 <i>Creating Device Variables</i> on page 4-11 for information on I/O port names.</p> <p>If entered manually, the variable name is simply the string you enter.</p>	Possible.
Data Type	The data type must have the same size as the data type of the <i>I/O port</i> .	Possible.
Initial Value	None ^{*2}	Possible.

Attribute	Setting	Changes to settings
AT	<ul style="list-style-type: none"> Device variables for EtherCAT slaves: ECAT://node#[node_number]/[I/O_port_name] Device variables for X Bus Units: XBus://unit#[Unit_number]/io/[I/O_port_name] Device variables for NX Units on CPU Rack: IOBus://unit#[NX_Unit_number]/I/O_port_name Device variables for NX Units on EtherCAT Slave Terminal: ECAT://node#[EtherCAT_Coupler_node_address, NX_Unit_number]/I/O_port_name Device variables for CJ-series Units: IOBus://rack#[rack_number]/slot#[slot_number]/[I/O_port_name] Device variables for built-in I/O port*1: BuiltInIO://cpu#[physical_port_number]/[I/O_port_name] Device variables for Option Boards*1: BuiltInIO://opt#[physical_port_number]/[I/O_port_name] 	Not possible.
Retain	<ul style="list-style-type: none"> Device variables for X Bus Units: Not retained. Device variables for NX Units: Not retained. Device variables for EtherCAT slaves: Not retained. Device variables for CJ-series Units assigned to the <i>Operation Data</i> (CIO Area): <i>Not retained</i>. Device variables for CJ-series Units assigned to the <i>Setup Data</i> (DM Area): <i>Retained</i>. Device variables for built-in I/O port*1: Not retained. Device variables for Option Boards*1: Not retained. 	Not possible.
Constant	Yes for variables assigned to <i>Setup Data</i> (DM Area) for an I/O port that is set to <i>R</i> (read-only). Other variables: <i>None</i>	Possible.
Network Publish	Do not publish.	Possible.
Comment	Enter a user-defined comment.	Possible.

- *1. This is available only for an NX1P2 Controller.
- *2. Some Basic I/O Units have more than one access method for the same I/O port, such as bit string data and BOOL data. If you use initial values for this type of I/O port, set the initial values for one of the access types to *None*.

Display in Variable Table

Name	Data Type	Initial Value	AT
J01_Ch1_Out	WORD	None	
J01_Ch1_Out00	BOOL	True	
J01_Ch1_Out01	BOOL	True	
J01_Ch1_Out02	BOOL	True	
J01_Ch1_Out03	BOOL	True	
J01_Ch1_Out04	BOOL	True	
J01_Ch1_Out05	BOOL	True	

To access the I/O port by bit, set the initial value to TRUE.

Set the initial value for word access to None.

Display in I/O Map

▼ Ch1_Out	Output CH1	RW	WORD	J01_Ch1_Out
Ch1_Out00	Output CH1 bit 00	RW	BOOL	J01_Ch1_Out00
Ch1_Out01	Output CH1 bit 01	RW	BOOL	J01_Ch1_Out01
Ch1_Out02	Output CH1 bit 02	RW	BOOL	J01_Ch1_Out02
Ch1_Out03	Output CH1 bit 03	RW	BOOL	J01_Ch1_Out03
Ch1_Out04	Output CH1 bit 04	RW	BOOL	J01_Ch1_Out04



Additional Information

- You can select any of the following items in the I/O Map to create a group of device variables at one time.

Port	Description	Access	Type	Variable
CPU/Expansion Racks				
CPU Rack 0				
CJ1W-OD232 (Transistor Output)				
Ch1_Out	Output CH1	RW	WORD	J01_Ch1_Out
Ch1_Out00	Output CH1 bit 00	RW	BOOL	J01_Ch1_Out00
Ch1_Out01	Output CH1 bit 01	RW	BOOL	J01_Ch1_Out01
Ch1_Out02	Output CH1 bit 02	RW	BOOL	J01_Ch1_Out02
Ch1_Out03	Output CH1 bit 03	RW	BOOL	J01_Ch1_Out03
Ch1_Out04	Output CH1 bit 04	RW	BOOL	J01_Ch1_Out04
Ch1_Out05	Output CH1 bit 05	RW	BOOL	J01_Ch1_Out05
Ch1_Out06	Output CH1 bit 06	RW	BOOL	J01_Ch1_Out06
Ch1_Out07	Output CH1 bit 07	RW	BOOL	J01_Ch1_Out07
Ch1_Out08	Output CH1 bit 08	RW	BOOL	J01_Ch1_Out08
Ch1_Out09	Output CH1 bit 09	RW	BOOL	J01_Ch1_Out09
Ch1_Out10	Output CH1 bit 10	RW	BOOL	J01_Ch1_Out10
Ch1_Out11	Output CH1 bit 11	RW	BOOL	J01_Ch1_Out11
Ch1_Out12	Output CH1 bit 12	RW	BOOL	J01_Ch1_Out12
Ch1_Out13	Output CH1 bit 13	RW	BOOL	J01_Ch1_Out13
Ch1_Out14	Output CH1 bit 14	RW	BOOL	J01_Ch1_Out14
Ch1_Out15	Output CH1 bit 15	RW	BOOL	J01_Ch1_Out15

- The operation results are given in the following table. The variables are created based on the user-defined Unit name and the selected I/O port name.

User action	Result
Selected one I/O port line	A variable for the selected I/O port is created. If the selected I/O port line contains other lower level I/O ports, variables for those lower level I/O ports are also created.
Selected multiple I/O port lines	Variables for the selected I/O ports are created. If the selected I/O port line contains other lower level I/O ports, variables for those lower level I/O ports are also created.
Selected a parent I/O port line	Variables for all I/O ports under the selected I/O port are created.
Selected a Unit line	Variables are created for all I/O ports of the selected Unit.
Selected network line	Variables are created for all I/O ports of the selected network.



Additional Information

- To register a variable in any other variable table besides the global variable table, change the variable table type in the *Variable Type* Column before selecting **Create Device Variables**. If you do not specify anything in the *Variable Type* Column, the variables are automatically registered in the global variable table.
If a variable of the same name already exists when you create a device variable, a "unique ID number" is appended to the end of the variable.
- You can copy variables from the I/O Map and paste them into a spreadsheet (e.g., Excel). Or, you can copy variables from a spreadsheet and paste them into the I/O Map. Copy the variable name, variable comment, and variable type columns (including the title row) on the spreadsheet, and then select the first variable at which to paste the data on the I/O Map and paste the data.
With Sysmac Studio version 1.05 or higher, you can paste the data on the I/O Map without copying the title row. You can also copy and paste just the variable name column or the variable name and variable comment columns. To do so, display the desired columns of the I/O Map. If pasting data to the I/O Map fails, the location where the paste failed is displayed on the Output Tab Page.

Copying and Pasting Variables between I/O Map and Spreadsheet

You can copy data from the I/O Map and paste it into a spreadsheet (e.g. Excel). Or, you can copy data edited in a spreadsheet and paste it into the I/O Map.

You can configure the I/O Map by registering the name of variables and comments to be assigned to each port in a spreadsheet and pasting the data into the I/O Map.

● Copying and Pasting Variables from the I/O Map into a Spreadsheet

If you paste the I/O Map data into a spreadsheet, the configuration is displayed as follows.

Data pasted in a spreadsheet is classified into four items.

(a)	Position	Port	Description	R/W	Data Type	Variable	Variable Comment	Variable Type
	EtherCAT Network Configuration							
	CPU/Expansion Racks							
	CPU Rack 0 CPU Rack 0							
	[00]	C-J1W-ID201 (DC Input Unit)						
		Ch1_In	Input CH1	R	WORD	I01	Input CH1 Comment	Global Variables
		Ch1_In00	Input CH1 bit 00	R	BOOL	I0100	Bit0 of Input CH1 Comment	Global Variables
		Ch1_In01	Input CH1 bit 01	R	BOOL	I0101	Bit1 of Input CH1 Comment	Global Variables
		Ch1_In02	Input CH1 bit 02	R	BOOL	I0102	Bit2 of Input CH1 Comment	Global Variables
		Ch1_In03	Input CH1 bit 03	R	BOOL	I0103	Bit3 of Input CH1 Comment	Global Variables
		Ch1_In04	Input CH1 bit 04	R	BOOL	I0104	Bit4 of Input CH1 Comment	Global Variables
		Ch1_In05	Input CH1 bit 05	R	BOOL	I0105	Bit5 of Input CH1 Comment	Global Variables
		Ch1_In06	Input CH1 bit 06	R	BOOL	I0106	Bit6 of Input CH1 Comment	Global Variables
		Ch1_In07	Input CH1 bit 07	R	BOOL	I0107	Bit7 of Input CH1 Comment	Global Variables
	[01]	C-J1W-OD201 (Transistor Output Unit)						
		Ch1_Out	Output CH1	RW	WORD	Q01	Output CH1 Comment	Global Variables
		Ch1_Out00	Output CH1 bit 00	RW	BOOL	Q0100	Bit0 of Output CH1 Comment	Global Variables
		Ch1_Out01	Output CH1 bit 01	RW	BOOL	Q0101	Bit1 of Output CH1 Comment	Global Variables
		Ch1_Out02	Output CH1 bit 02	RW	BOOL	Q0102	Bit2 of Output CH1 Comment	Global Variables
		Ch1_Out03	Output CH1 bit 03	RW	BOOL	Q0103	Bit3 of Output CH1 Comment	Global Variables
		Ch1_Out04	Output CH1 bit 04	RW	BOOL	Q0104	Bit4 of Output CH1 Comment	Global Variables
		Ch1_Out05	Output CH1 bit 05	RW	BOOL	Q0105	Bit5 of Output CH1 Comment	Global Variables
		Ch1_Out06	Output CH1 bit 06	RW	BOOL	Q0106	Bit6 of Output CH1 Comment	Global Variables
		Ch1_Out07	Output CH1 bit 07	RW	BOOL	Q0107	Bit7 of Output CH1 Comment	Global Variables

	Name	Meaning	Editing	Remarks
(a)	Column header	Displays the item for each column.	No	The first row only
(b)	Device information	Displays information on each device.	No	Variable information is write-protected on the I/O Map.
(c)	Port information	Displays the port information on each device.	No	Consists of five data: Position (always blank), port name, port description, read/write attribute, and data type.
(d)	Variable information	Displays variable information that is assigned to each port.	Yes	Consists of three data: Variable, variable comment, and variable type.

If more than one device is registered in the I/O Map, (b) *Device information*, (c) *Port information*, and (d) *Variable information* are pasted by device.

Copying and Pasting Variables from a Spreadsheet into the I/O Map

When you paste data edited in a spreadsheet into the I/O Map, you need to follow the rules for pasted data so that they are properly identified in the Sysmac Studio. Paste data according to the following rules.

● (a) When All I/O Map Data Including (a) Column Header Is Copied from a Spreadsheet and Pasted into the I/O Map

1 Delete the row of (b) *Device information* for the first device under (a) *Column header* before copying data.

If you copy data of multiple devices, copy the data without deleting rows of (b) *Device information* of the second and subsequent devices.

2 Select the top port of the top device on the I/O Map and paste the data.

● Operation Example of (a)

- Creating variable data of a newly added device in a spreadsheet and pasting it into the I/O Map

1 If you create a device configuration on the Sysmac Studio, the I/O Map is automatically created. Display and right-click the I/O Map and select **Expand All/Collapse All**. Ports for each device are displayed.

Position	Port	Description	R/W	Data Type	Variable	Variable Comment	Variable Type
	EtherCAT Network Configuration						
	CPU/Expansion Racks						
	CPU Rack 0						
CPU Rack [00]	CJ1W-ID201 (DC Input Unit)						
	Ch1_In	Input CH1	R	WORD			
	Ch1_In00	Input CH1 bit 00	R	BOOL			
	Ch1_In01	Input CH1 bit 01	R	BOOL			
	Ch1_In02	Input CH1 bit 02	R	BOOL			
	Ch1_In03	Input CH1 bit 03	R	BOOL			
	Ch1_In04	Input CH1 bit 04	R	BOOL			
	Ch1_In05	Input CH1 bit 05	R	BOOL			
	Ch1_In06	Input CH1 bit 06	R	BOOL			
	Ch1_In07	Input CH1 bit 07	R	BOOL			
CPU Rack [01]	CJ1W-OD201 (Transistor Output Unit)						
	Ch1_Out	Output CH1	RW	WORD			
	Ch1_Out00	Output CH1 bit 00	RW	BOOL			
	Ch1_Out01	Output CH1 bit 01	RW	BOOL			
	Ch1_Out02	Output CH1 bit 02	RW	BOOL			
	Ch1_Out03	Output CH1 bit 03	RW	BOOL			
	Ch1_Out04	Output CH1 bit 04	RW	BOOL			
	Ch1_Out05	Output CH1 bit 05	RW	BOOL			
	Ch1_Out06	Output CH1 bit 06	RW	BOOL			
	Ch1_Out07	Output CH1 bit 07	RW	BOOL			

2 Select the overall I/O Map with the Ctrl + A Keys, copy it with the Ctrl + C Keys, select a cell on the upper left corner in a spreadsheet, and then paste the data.

Position	Port	Description	R/W	Data Type	Variable	Variable Comment	Variable Type
	EtherCAT Network Configuration						
	CPU/Expansion Racks						
	CPU Rack 0						
[00]	C-J1W-ID201 (DC Input Unit)						
	Ch1_In	Input CH1	R	WORD			
	Ch1_In00	Input CH1 bit 00	R	BOOL			
	Ch1_In01	Input CH1 bit 01	R	BOOL			
	Ch1_In02	Input CH1 bit 02	R	BOOL			
	Ch1_In03	Input CH1 bit 03	R	BOOL			
	Ch1_In04	Input CH1 bit 04	R	BOOL			
	Ch1_In05	Input CH1 bit 05	R	BOOL			
	Ch1_In06	Input CH1 bit 06	R	BOOL			
	Ch1_In07	Input CH1 bit 07	R	BOOL			
[01]	C-J1W-OD201 (Transistor Output Unit)						
	Ch1_Out	Output CH1	RW	WORD			
	Ch1_Out00	Output CH1 bit 00	RW	BOOL			
	Ch1_Out01	Output CH1 bit 01	RW	BOOL			
	Ch1_Out02	Output CH1 bit 02	RW	BOOL			
	Ch1_Out03	Output CH1 bit 03	RW	BOOL			
	Ch1_Out04	Output CH1 bit 04	RW	BOOL			
	Ch1_Out05	Output CH1 bit 05	RW	BOOL			
	Ch1_Out06	Output CH1 bit 06	RW	BOOL			
	Ch1_Out07	Output CH1 bit 07	RW	BOOL			

3 Delete the line of (b) Device information under (a) Column header.

Position	Port	Description	R/W	Data Type	Variable	Variable Comment	Variable Type
	Ch1_In	Input CH1	R	WORD			
	Ch1_In00	Input CH1 bit 00	R	BOOL			
	Ch1_In01	Input CH1 bit 01	R	BOOL			
	Ch1_In02	Input CH1 bit 02	R	BOOL			
	Ch1_In03	Input CH1 bit 03	R	BOOL			
	Ch1_In04	Input CH1 bit 04	R	BOOL			
	Ch1_In05	Input CH1 bit 05	R	BOOL			
	Ch1_In06	Input CH1 bit 06	R	BOOL			
	Ch1_In07	Input CH1 bit 07	R	BOOL			
[01]	C-J1W-OD201 (Transistor Output Unit)						
	Ch1_Out	Output CH1	RW	WORD			
	Ch1_Out00	Output CH1 bit 00	RW	BOOL			
	Ch1_Out01	Output CH1 bit 01	RW	BOOL			
	Ch1_Out02	Output CH1 bit 02	RW	BOOL			
	Ch1_Out03	Output CH1 bit 03	RW	BOOL			
	Ch1_Out04	Output CH1 bit 04	RW	BOOL			
	Ch1_Out05	Output CH1 bit 05	RW	BOOL			
	Ch1_Out06	Output CH1 bit 06	RW	BOOL			
	Ch1_Out07	Output CH1 bit 07	RW	BOOL			

4 Register variables and variable comments on the spreadsheet.

Position	Port	Description	R/W	Data Type	Variable	Variable Comment	Variable Type
	Ch1_In	Input CH1	R	WORD	I01	Input CH1 Comment	
	Ch1_In00	Input CH1 bit 00	R	BOOL	I0100	Bit0 of Input CH1 Comment	
	Ch1_In01	Input CH1 bit 01	R	BOOL	I0101	Bit1 of Input CH1 Comment	
	Ch1_In02	Input CH1 bit 02	R	BOOL	I0102	Bit2 of Input CH1 Comment	
	Ch1_In03	Input CH1 bit 03	R	BOOL	I0103	Bit3 of Input CH1 Comment	
	Ch1_In04	Input CH1 bit 04	R	BOOL	I0104	Bit4 of Input CH1 Comment	
	Ch1_In05	Input CH1 bit 05	R	BOOL	I0105	Bit5 of Input CH1 Comment	
	Ch1_In06	Input CH1 bit 06	R	BOOL	I0106	Bit6 of Input CH1 Comment	
	Ch1_In07	Input CH1 bit 07	R	BOOL	I0107	Bit7 of Input CH1 Comment	
[01]	C-J1W-OD201 (Transistor Output Unit)						
	Ch1_Out	Output CH1	RW	WORD	Q01	Output CH1 Comment	
	Ch1_Out00	Output CH1 bit 00	RW	BOOL	Q0100	Bit0 of Output CH1 Comment	
	Ch1_Out01	Output CH1 bit 01	RW	BOOL	Q0101	Bit1 of Output CH1 Comment	
	Ch1_Out02	Output CH1 bit 02	RW	BOOL	Q0102	Bit2 of Output CH1 Comment	
	Ch1_Out03	Output CH1 bit 03	RW	BOOL	Q0103	Bit3 of Output CH1 Comment	
	Ch1_Out04	Output CH1 bit 04	RW	BOOL	Q0104	Bit4 of Output CH1 Comment	
	Ch1_Out05	Output CH1 bit 05	RW	BOOL	Q0105	Bit5 of Output CH1 Comment	
	Ch1_Out06	Output CH1 bit 06	RW	BOOL	Q0106	Bit6 of Output CH1 Comment	
	Ch1_Out07	Output CH1 bit 07	RW	BOOL	Q0107	Bit7 of Output CH1 Comment	

5 Select all data with the Ctrl + A Keys on the spreadsheet and copy the data with the Ctrl + C Keys.

Position	Port	Description	R/W	Data Type	Variable	Variable Comment	Variable Type
	Ch1_In	Input CH1	R	WORD	I01	Input CH1 Comment	
	Ch1_In00	Input CH1 bit 00	R	BOOL	I0100	Bit0 of Input CH1 Comment	
	Ch1_In01	Input CH1 bit 01	R	BOOL	I0101	Bit1 of Input CH1 Comment	
	Ch1_In02	Input CH1 bit 02	R	BOOL	I0102	Bit2 of Input CH1 Comment	
	Ch1_In03	Input CH1 bit 03	R	BOOL	I0103	Bit3 of Input CH1 Comment	
	Ch1_In04	Input CH1 bit 04	R	BOOL	I0104	Bit4 of Input CH1 Comment	
	Ch1_In05	Input CH1 bit 05	R	BOOL	I0105	Bit5 of Input CH1 Comment	
	Ch1_In06	Input CH1 bit 06	R	BOOL	I0106	Bit6 of Input CH1 Comment	
	Ch1_In07	Input CH1 bit 07	R	BOOL	I0107	Bit7 of Input CH1 Comment	
[01]	CJ1W-OD201 (Transistor Output Unit)						
	Ch1_Out	Output CH1	RW	WORD	Q01	Output CH1 Comment	
	Ch1_Out00	Output CH1 bit 00	RW	BOOL	Q0100	Bit0 of Output CH1 Comment	
	Ch1_Out01	Output CH1 bit 01	RW	BOOL	Q0101	Bit1 of Output CH1 Comment	
	Ch1_Out02	Output CH1 bit 02	RW	BOOL	Q0102	Bit2 of Output CH1 Comment	
	Ch1_Out03	Output CH1 bit 03	RW	BOOL	Q0103	Bit3 of Output CH1 Comment	
	Ch1_Out04	Output CH1 bit 04	RW	BOOL	Q0104	Bit4 of Output CH1 Comment	
	Ch1_Out05	Output CH1 bit 05	RW	BOOL	Q0105	Bit5 of Output CH1 Comment	
	Ch1_Out06	Output CH1 bit 06	RW	BOOL	Q0106	Bit6 of Output CH1 Comment	
	Ch1_Out07	Output CH1 bit 07	RW	BOOL	Q0107	Bit7 of Output CH1 Comment	

6 Paste the copied data into the I/O Map. Specify the top port of the top device as paste position.

Position	Port	Description	R/W	Data Type	Variable	Variable Comment	Variable Type
	EtherCAT Network Configuration						
	CPU/Expansion Racks						
	CPU Rack						
[00]	CPU Rack 0						
	CJ1W-ID201 (DC Input Unit)						
	Ch1_In	Input CH1	R	WORD			
	Ch1_In00	Input CH1 bit 00	R	BOOL			
	Ch1_In01	Input CH1 bit 01	R	BOOL			

All variables are pasted as global variables.

Position	Port	Description	R/W	Data Type	Variable	Variable Comment	Variable Type
	EtherCAT Network Configuration						
	CPU/Expansion Racks						
	CPU Rack						
[00]	CPU Rack 0						
	CJ1W-ID201 (DC Input Unit)						
	Ch1_In	Input CH1	R	WORD	I01	Input CH1 Comment	Global Variables
	Ch1_In00	Input CH1 bit 00	R	BOOL	I0100	Bit0 of Input CH1 Comment	Global Variables
	Ch1_In01	Input CH1 bit 01	R	BOOL	I0101	Bit1 of Input CH1 Comment	Global Variables
	Ch1_In02	Input CH1 bit 02	R	BOOL	I0102	Bit2 of Input CH1 Comment	Global Variables
	Ch1_In03	Input CH1 bit 03	R	BOOL	I0103	Bit3 of Input CH1 Comment	Global Variables
	Ch1_In04	Input CH1 bit 04	R	BOOL	I0104	Bit4 of Input CH1 Comment	Global Variables
	Ch1_In05	Input CH1 bit 05	R	BOOL	I0105	Bit5 of Input CH1 Comment	Global Variables
	Ch1_In06	Input CH1 bit 06	R	BOOL	I0106	Bit6 of Input CH1 Comment	Global Variables
	Ch1_In07	Input CH1 bit 07	R	BOOL	I0107	Bit7 of Input CH1 Comment	Global Variables
[01]	CJ1W-OD201 (Transistor Output Unit)						
	Ch1_Out	Output CH1	RW	WORD	Q01	Output CH1 Comment	Global Variables
	Ch1_Out00	Output CH1 bit 00	RW	BOOL	Q0100	Bit0 of Output CH1 Comment	Global Variables
	Ch1_Out01	Output CH1 bit 01	RW	BOOL	Q0101	Bit1 of Output CH1 Comment	Global Variables
	Ch1_Out02	Output CH1 bit 02	RW	BOOL	Q0102	Bit2 of Output CH1 Comment	Global Variables
	Ch1_Out03	Output CH1 bit 03	RW	BOOL	Q0103	Bit3 of Output CH1 Comment	Global Variables
	Ch1_Out04	Output CH1 bit 04	RW	BOOL	Q0104	Bit4 of Output CH1 Comment	Global Variables
	Ch1_Out05	Output CH1 bit 05	RW	BOOL	Q0105	Bit5 of Output CH1 Comment	Global Variables
	Ch1_Out06	Output CH1 bit 06	RW	BOOL	Q0106	Bit6 of Output CH1 Comment	Global Variables
	Ch1_Out07	Output CH1 bit 07	RW	BOOL	Q0107	Bit7 of Output CH1 Comment	Global Variables

7 If you change them to local variables, change the *Variable Type* to the (POU name) Internals.

Position	Port	Description	R/W	Data Type	Variable	Variable Comment	Variable Type
[01]	CJ1W-OD201 (Transistor Output Unit)						
	Ch1_Out	Output CH1	RW	WORD	Q01	Output CH1 Comment	Program0 Internals
	Ch1_Out00	Output CH1 bit 00	RW	BOOL	Q0100	Bit0 of Output CH1 Comment	Program0 Internals
	Ch1_Out01	Output CH1 bit 01	RW	BOOL	Q0101	Bit1 of Output CH1 Comment	Program0 Internals
	Ch1_Out02	Output CH1 bit 02	RW	BOOL	Q0102	Bit2 of Output CH1 Comment	Program0 Internals
	Ch1_Out03	Output CH1 bit 03	RW	BOOL	Q0103	Bit3 of Output CH1 Comment	Program0 Internals
	Ch1_Out04	Output CH1 bit 04	RW	BOOL	Q0104	Bit4 of Output CH1 Comment	Program0 Internals
	Ch1_Out05	Output CH1 bit 05	RW	BOOL	Q0105	Bit5 of Output CH1 Comment	Program0 Internals
	Ch1_Out06	Output CH1 bit 06	RW	BOOL	Q0106	Bit6 of Output CH1 Comment	Program0 Internals
	Ch1_Out07	Output CH1 bit 07	RW	BOOL	Q0107	Bit7 of Output CH1 Comment	Program0 Internals

● **b) When Only (d) Variable Information of Some Devices Is Copied from a Spreadsheet and Pasted into the I/O Map**

- 1** Copy all (d) Variable information to apply to the I/O Map.
If you select all (d) Variable information of multiple devices at once, select it in a rectangle without separation.
- 2** Specify a port position to paste copied data on the I/O Map and paste the data.

● **Operation Example of (b)**

- Changing some data of variables assigned to a port on a spreadsheet and pasting the data into the I/O Map

- 1** Select a port to change the variable information on the I/O Map and copy the data with Ctrl + C Keys.

	Ch1_In04	Input CH1 bit 04	R	BOOL	I0104	Bit4 of Input CH1 Comment	Global Variables
	Ch1_In05	Input CH1 bit 05	R	BOOL	I0105	Bit5 of Input CH1 Comment	Global Variables
	Ch1_In06	Input CH1 bit 06	R	BOOL	I0106	Bit6 of Input CH1 Comment	Global Variables
	Ch1_In07	Input CH1 bit 07	R	BOOL	I0107	Bit7 of Input CH1 Comment	Global Variables
[01]	▼ CJ1W-OD201 (Transistor Output Unit)						
	▼ Ch1_Out	Output CH1	RW	WORD	Q01	Output CH1 Comment	Global Variables
	Ch1_Out00	Output CH1 bit 00	RW	BOOL	Q0100	Bit0 of Output CH1 Comment	Global Variables
	Ch1_Out01	Output CH1 bit 01	RW	BOOL	Q0101	Bit1 of Output CH1 Comment	Global Variables
	Ch1_Out02	Output CH1 bit 02	RW	BOOL	Q0102	Bit2 of Output CH1 Comment	Global Variables

- 2** Paste it into a spreadsheet.

Positic	Port	Description	R/W	Data Type	Variable	Variable Comment	Variable Type
	Ch1_In04	Input CH1 bit 04	R	BOOL	I01 04	Bit4 of Input CH1 Comment	Global Variables
	Ch1_In05	Input CH1 bit 05	R	BOOL	I01 05	Bit5 of Input CH1 Comment	Global Variables
	Ch1_In06	Input CH1 bit 06	R	BOOL	I01 06	Bit6 of Input CH1 Comment	Global Variables
	Ch1_In07	Input CH1 bit 07	R	BOOL	I01 07	Bit7 of Input CH1 Comment	Global Variables
[01]	CJ1W-OD201 (Transistor Output Unit)						
	Ch1_Out	Output CH1	RW	WORD	Q01	Output CH1 Comment	Global Variables
	Ch1_Out00	Output CH1 bit 00	RW	BOOL	Q01 00	Bit0 of Output CH1 Comment	Global Variables
	Ch1_Out01	Output CH1 bit 01	RW	BOOL	Q01 01	Bit1 of Output CH1 Comment	Global Variables
	Ch1_Out02	Output CH1 bit 02	RW	BOOL	Q01 02	Bit2 of Output CH1 Comment	Global Variables

- 3** Change the variable information, select the changed part, and copy it with the Ctrl + C Keys.

Variable
I01 04M
I01 05M
I01 06M
I01 07M
Q01 M
Q01 00M
Q01 01 M
Q01 02M

- 4** Select the target port on the I/O Map and paste the changed data.
If you change variable names in a spreadsheet, variables assigned to the port on the I/O Map are deleted when the data is pasted. If you want to retain the variables, right-click the device and select **Reset Assignment** from the pop-up menu.

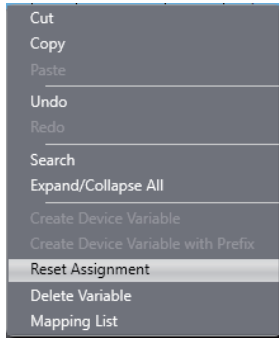

The changed variable information is applied to the I/O Map.

	Port	Description	R/W	Data Type	Variable	Variable Comment	Variable Type
	Ch1_In04	Input CH1 bit 04	R	BOOL	I0104M	Bit4 of Input CH1 Comment	Global Variables
	Ch1_In05	Input CH1 bit 05	R	BOOL	I0105M	Bit5 of Input CH1 Comment	Global Variables
	Ch1_In06	Input CH1 bit 06	R	BOOL	I0106M	Bit6 of Input CH1 Comment	Global Variables
	Ch1_In07	Input CH1 bit 07	R	BOOL	I0107M	Bit7 of Input CH1 Comment	Global Variables
[01]	▼ CJ1W-OD201 (Transistor Output Unit)						
	▼ Ch1_Out						
	Ch1_Out00	Output CH1	RW	WORD	Q01M	Output CH1 Comment	Global Variables
	Ch1_Out01	Output CH1 bit 00	RW	BOOL	Q0100M	Bit0 of Output CH1 Comment	Global Variables
	Ch1_Out02	Output CH1 bit 01	RW	BOOL	Q0101M	Bit1 of Output CH1 Comment	Global Variables
	Ch1_Out03	Output CH1 bit 02	RW	BOOL	Q0102M	Bit2 of Output CH1 Comment	Global Variables
	Ch1_Out04	Output CH1 bit 03	RW	BOOL	Q0103M	Bit3 of Output CH1 Comment	Global Variables



Precautions for Correct Use

Variable names and comments of ports whose data type is array cannot be properly pasted from a spreadsheet into the I/O Map.

When you copy all I/O Map data including (a) *Column header* and paste the data into the I/O Map, data of ports whose data type is array may be included. Pasting the data may fail in that case.



Additional Information

Using the leftmost column in the figure below makes it easy to select a row of the port on the I/O Map.

Position	Port	Description	R/W	Data Type	Variable	Variable Comment	Variable Type
	▼ EtherCAT Network Configuration						
	▼ CPU/Expansion Racks						
PU Rack	▼ CPU Rack 0						
[00]	▼ CJ1W-ID201 (DC Input Unit)						
	▼ Ch1_In	Input CH1	R	WORD			
	Ch1_In00	Input CH1 bit 00	R	BOOL			
	Ch1_In01	Input CH1 bit 01	R	BOOL			
	Ch1_In02	Input CH1 bit 02	R	BOOL			
	Ch1_In03	Input CH1 bit 03	R	BOOL			
	Ch1_In04	Input CH1 bit 04	R	BOOL			
	Ch1_In05	Input CH1 bit 05	R	BOOL			
	Ch1_In06	Input CH1 bit 06	R	BOOL			
	Ch1_In07	Input CH1 bit 07	R	BOOL			
[01]	▼ CJ1W-OD201 (Transistor Output Unit)						
	▼ Ch1_Out	Output CH1	RW	WORD			
	Ch1_Out00	Output CH1 bit 00	RW	BOOL			
	Ch1_Out01	Output CH1 bit 01	RW	BOOL			
	Ch1_Out02	Output CH1 bit 02	RW	BOOL			
	Ch1_Out03	Output CH1 bit 03	RW	BOOL			
	Ch1_Out04	Output CH1 bit 04	RW	BOOL			
	Ch1_Out05	Output CH1 bit 05	RW	BOOL			
	Ch1_Out06	Output CH1 bit 06	RW	BOOL			
	Ch1_Out07	Output CH1 bit 07	RW	BOOL			

Click the column to select a row.

4-1-3 Creating Local Variables

- Creating Local Variables

You can register variables that are used only within one POU (program, function, or function block). The following variable groups exist for local variables.

Variable group for local variables	Description	POU type		
		Program	Function	Function block
Internal variables	Used to create local variables for use in programs and internal variables for use in functions or function blocks.	Supported.	Supported.	Supported.
Input/output variables	Used to create input variables, output variables, and in-out variables for use in functions or function blocks.	---	Supported.	Supported.
External variables	Used to register variables from the global variable table. You can create external variables to access external data from within a POU (program, function, or function block).	Supported.	Supported.	Supported.
Return values	Used to register return values of functions.	---	Supported.	---

● Opening the Local Variable Tab Page

The following is an example that uses a registered ladder diagram program. Refer to 4-2 *Registering POUs* on page 4-57 for information on creating programs, functions, and function blocks (POUs).

- 1 Double-click **Section0** under **Programming - POUs - Programs - Program0** in the Multiview Explorer. The section is displayed in the Edit Pane.

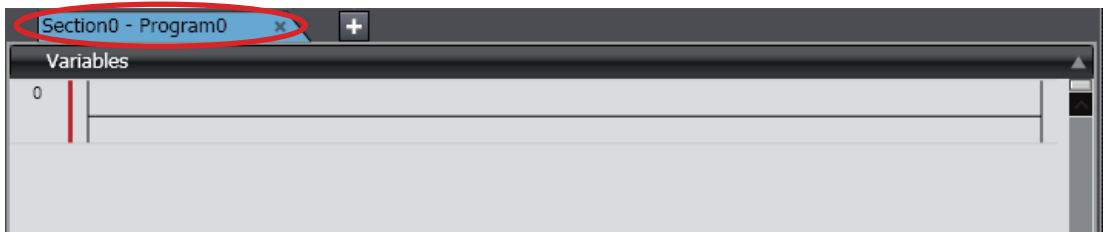

- 2 Click the **Variables** Bar. Or, press the Ctrl+Shift+V Keys.

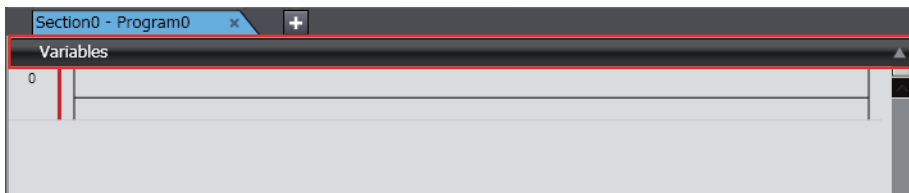

The local variable table is displayed.

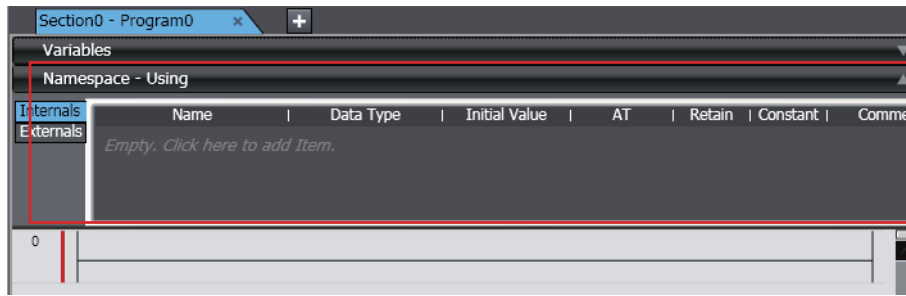

- 3 Select the variable group from the side tabs in the local variable table and register the local variable.

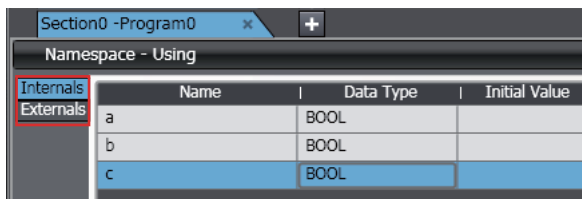

Additional Information

You can change the display position for the local variable table in the option settings. Refer to *8-26 Sysmac Studio Option Settings* on page 8-166 for details.

● Creating Local Variables

Local variables are created in the same way as global variables.
You can create them directly in the Ladder Editor.

- 1 In the Ladder Editor, select a new input or new output and click **Enter Variable**.



- 2 Enter a new variable name.
The variable name that you entered is registered in the Internals Side Tab Page.

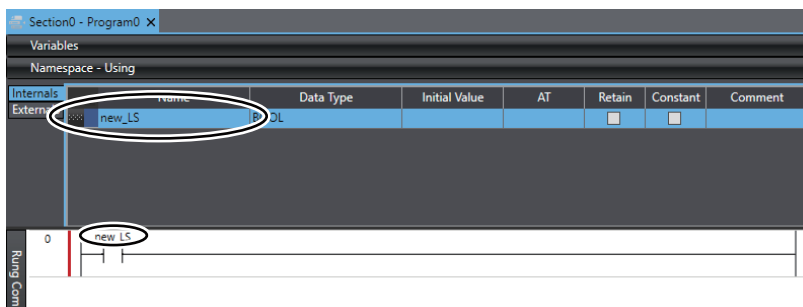



Additional Information

You can also register new variables that are entered into the ST Editor as internal variables. Refer to *Registering Variables on the ST Editor* on page 4-158 for the procedure.

● Editing, Deleting, and Copying and Pasting Local Variables, and Selecting and Moving Rows

You can edit, delete, copy, and paste local variables, and select and move rows with the same procedures as for global variables.



Additional Information

If you change the name of a local variable in the variable table, you can also change the name of the variable in the program at the same time. Set the *Change the variable name used in programs* Check Box in the option settings. Refer to *8-26 Sysmac Studio Option Settings* on page 8-166 for details.

● Sorting, Filtering, and Showing/Hiding Columns in Local Variable Tables

You can sort, filter, and show/hide columns in a local variable table with the same procedures as for the global variable table.

● Moving Internal Variables

You can move internal variables to the global variables.

- 1 Right-click the internal variable to move and select **Move to Global** from the pop-up menu.

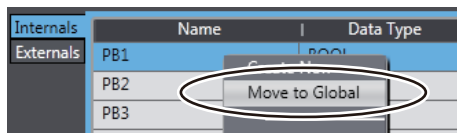

The selected variable is registered in the global variable table and also moved from the internal variables to the external variables.



● Moving External Variables

You can move external variables (global variables) to the internal variables.

- 1 Right-click the external variable to move and select **Move to Internals** from the pop-up menu.

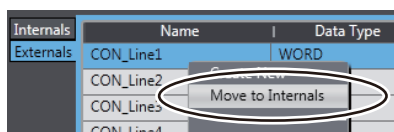

The selected variable is moved from the external variables to the internal variables.

Internals	Name	Data Type
Externals	PB1	BOOL
	PB2	BOOL
	PB3	BOOL
	LS_AA1	BOOL
	LS_AA2	BOOL
	CON_Line1	WORD



Precautions for Correct Use

If you move an external variable to an internal variable, a dialog box is displayed to confirm whether to delete the global variable that corresponds to the external variable. Delete a global variable only after confirming that it is not used in any other POU.

● Applying Change in In-Out Variables to a Ladder Program

When you change the in-out variables of a function or function block, you can apply the change to a called function or function block on a ladder program.

- 1 Right-click the in-out variable group and select **Apply inputs and outputs to the ladder program** from the pop-up menu.

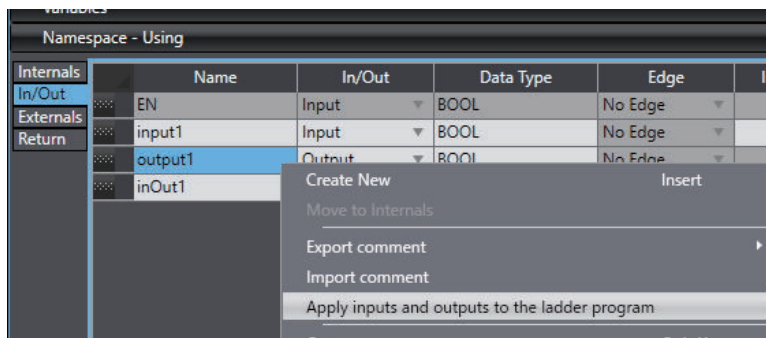

A message box appears to confirm whether you want to update all functions and function blocks called.

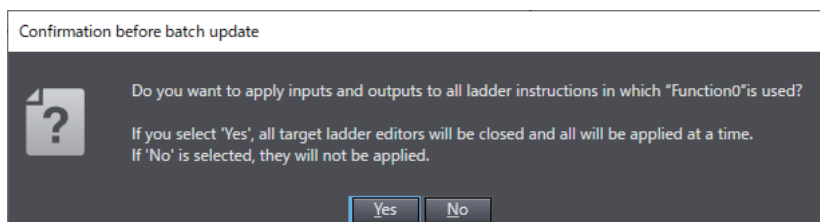

● Applying Return Values to a Ladder Program

When you change the data type of return values and comments of a function, you can apply the change to the called function on a ladder program.

- 1 Right-click the return value variable group and select **Apply return values to the ladder program** from the pop-up menu.

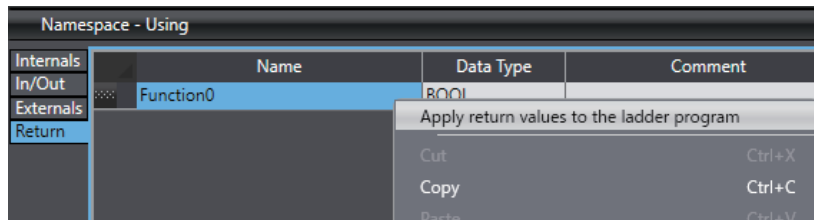

A message box appears to confirm whether you want to update all functions called.

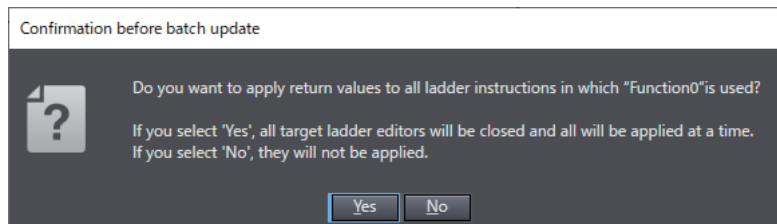

Additional Information

If you right-click on a function or a function block called on a ladder program and select **Update** from the pop-up menu, change in in-out variables of functions or function blocks and return values of functions can be applied.

4-1-4 Creating Axis Variables

- Axis Variables

An Axis Variable is a structure variable that is used to specify an axis in a program. An Axis Variable contains members used for axis control (axis settings) and members used to monitor the status of the axis in the programs or Sysmac Studio (axis monitor).

- **Creating Axis Variables**

When you create an axis in the **Axis Settings**, the Axis Variable is automatically added as a global variable.

- 1 Right-click **Axis Settings** under **Configurations and Setup – Motion Control Setup** in the Multiview Explorer and select **Add – Motion Control Axis** from the menu.

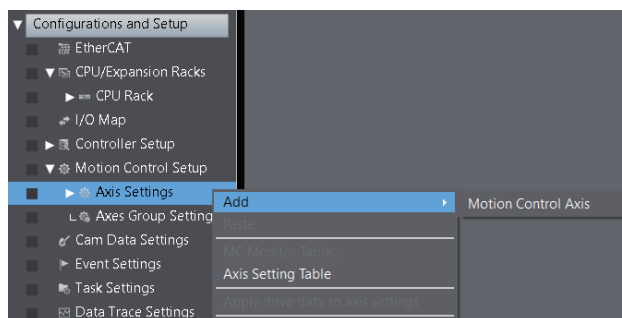

MC_Axis000 is added to the tree.

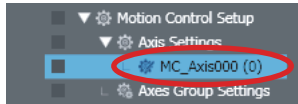

- 2 Double-click **Global Variables** under **Programming - Data** in the Multiview Explorer.

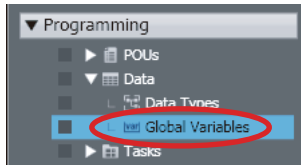

The MC_Axis000 Axis Variable is automatically added to the global variable table.

Name	Data Type	Initial Value	AT	Retain	Constant	Network Publish	Comment
MC_Axis000	AXIS_REF		MC://_MC...	<input type="checkbox"/>	<input checked="" type="checkbox"/>	Do not publish	

● Changing Axis Variable Names

- 1 Right-click the Axis Variable to rename in the Multiview Explorer and select **Rename** from the menu.

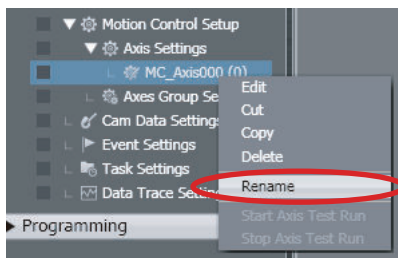

- 2 Enter a new name for the Axis Variable.

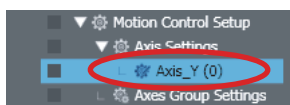

● Deleting Axis Variables

- 1 Right-click the Axis Variable to delete in the Multiview Explorer and select **Delete** from the menu.

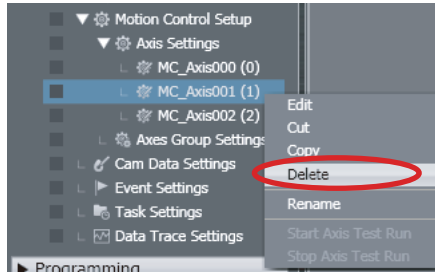

A deletion confirmation dialog box is displayed.

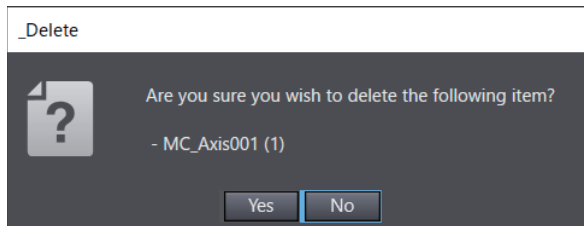

- 2 Click the **Yes** Button.
- 3 Double-click **Global Variables** under **Programming - Data** in the Multiview Explorer.

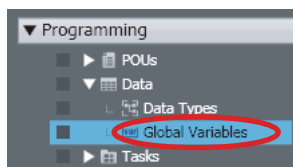

You can confirm that the Axis Variable was automatically deleted.

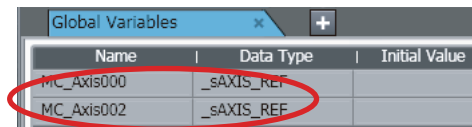

● Copying Axis Variables

- 1 Right-click the Axis Variable to copy in the Multiview Explorer and select **Copy** from the menu.

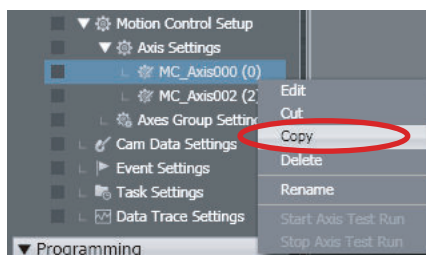

The specified Axis Variable is copied.

- 2 Right-click Axis Settings in the Multiview Explorer and select **Paste** from the menu.

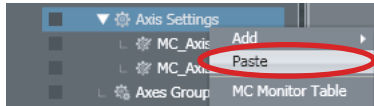

A copy of the Axis Variable is registered with *Copy_1_of* added to the front of the name of the Axis Variable that was copied.

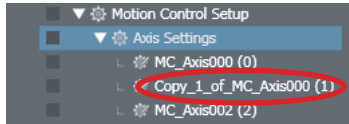

4-1-5 Creating Axes Group Variables

- Axes Group Variables

An Axes Group Variable is a structure variable that is used to specify an axes group that represents axes linked for synchronization or interpolation in programs.

- **Creating Axes Group Variables**

When you create an axes group, the Axes Group Variable is automatically added as a global variable.

- 1** Right-click **Axis Group Settings** under **Configurations and Setup - Motion Control Setup** in the Multiview Explorer and select **Add - Axes Group Settings** from the menu.

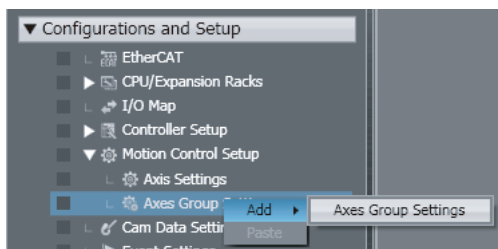

MC_Group000 is added to the tree.

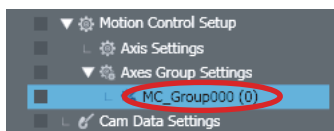

- 2** Double-click **Global Variables** under **Programming - Data** in the Multiview Explorer.

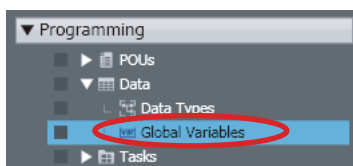

You can confirm that the MC_Group000 Axes Group Variable was automatically added.

Name	Data Type	Initial Value
MC_Group000	_sGROUP_REF	

● Changing Axes Group Names

- 1 Right-click the Axes Group Variable to rename in the Multiview Explorer and select **Rename** from the menu.

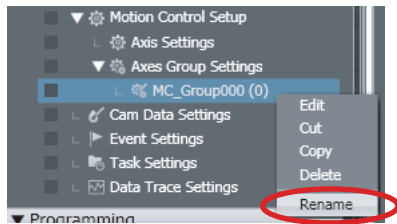

- 2 Enter a new name for the axes group.

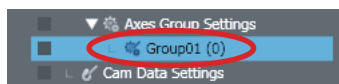

● Deleting Axes Group Variables

- 1 Right-click the Axes Group Variable to delete in the Multiview Explorer and select **Delete** from the menu.

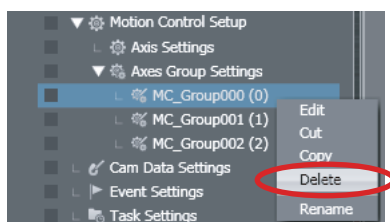

A deletion confirmation dialog box is displayed.

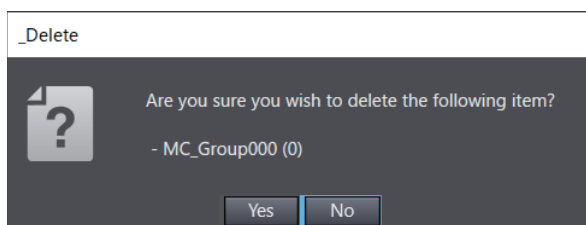

- 2 Click the **Yes** Button.
- 3 Double-click **Global Variables** under **Programming - Data** in the Multiview Explorer.

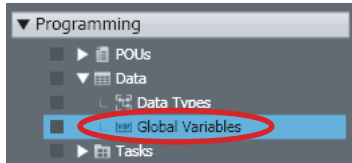

You can confirm that the Axes Group Variable was automatically deleted.

Name	Data Type	Initial Value
MC_Group001	_sGROUP_REF	
MC_Group002	_sGROUP_REF	

● Copying Axes Group Variables

- 1 Right-click the Axes Group Variable to copy in the Multiview Explorer and select **Copy** from the menu.

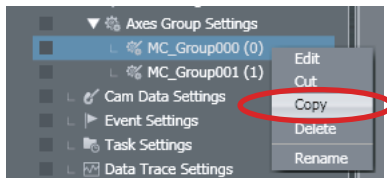

The specified Axes Group Variable is copied.

- 2 Right-click the Axes Group Variable in the Multiview Explorer and select **Paste** from the menu.

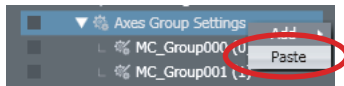

A copy of the Axes Group Variable is registered with *Copy_1_of* added to the front of the name of the Axes Group Variable that was copied.

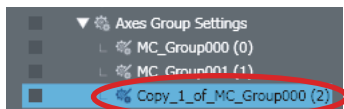

4-1-6 Creating Cam Data Variables

- Cam Data Variables

A cam data variable defines the motion of a slave axis in relation to a master axis for synchronization and interpolation motions for electronic gears and cams. This allows you to use variables in programs to define cam motions.

● Creating Cam Data Variables

When you create cam data, the cam data variable is automatically added as a global variable.

- 1 Right-click **Cam Data Settings** under **Configurations and Setup** in the Multiview Explorer and select **Add - CamProfile** from the menu.

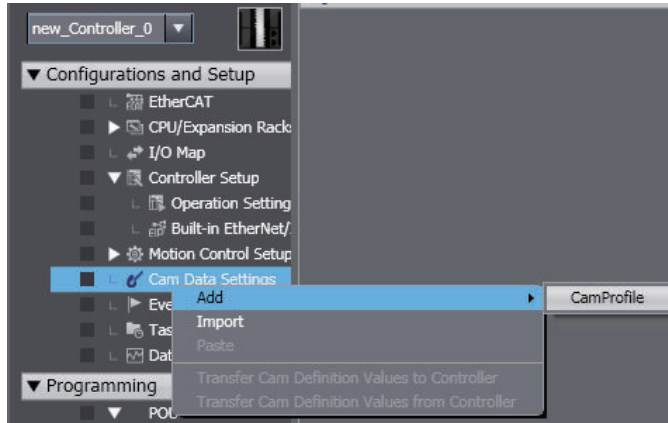

Cam profile 0 is added to the tree.

- 2 Double-click **Global Variables** under **Programming - Data** in the Multiview Explorer.

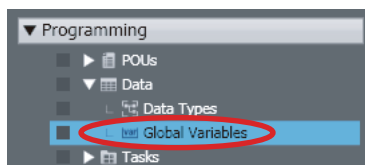

You can confirm that the cam data variable was automatically added.

Name	Data Type	Initial Value
CamProfile0	ARRAY[0..0] OF ...	None

● Changing Cam Data Variable Names

- 1 Right-click the cam data variable to rename in the Multiview Explorer and select **Rename** from the menu.

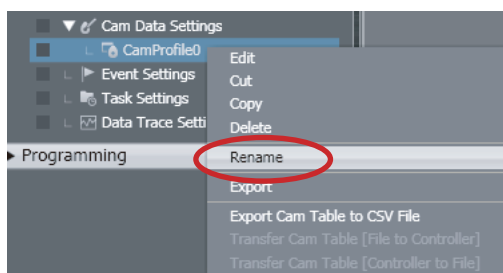

- 2 Enter a new cam data variable name.

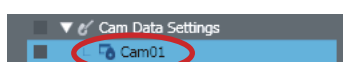

● Deleting Cam Data Variables

- 1 Right-click the cam data variable to delete in the Multiview Explorer and select **Delete** from the menu.

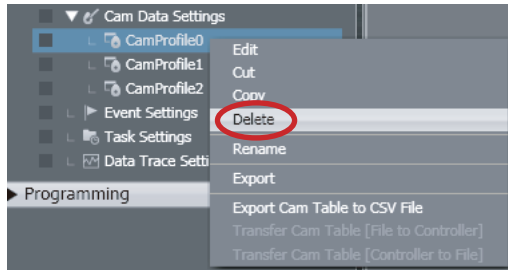

A deletion confirmation dialog box is displayed.

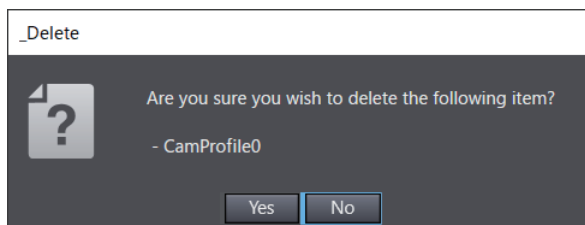

- 2 Click the **Yes** Button.
- 3 Double-click **Global Variables** under **Programming - Data** in the Multiview Explorer.

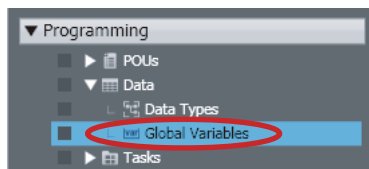

You can confirm that the cam data variable was automatically deleted.

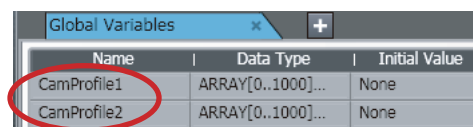

● Copying Cam Data Variables

- 1 Right-click the cam data to copy in the Multiview Explorer and select **Copy** from the menu.

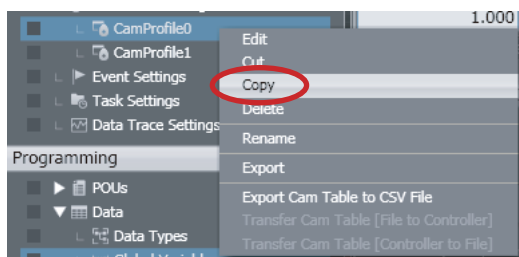

- Right-click **Cam Data Settings** under **Configurations and Setup** in the Multiview Explorer and select **Paste** from the menu.

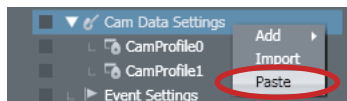

A copy of the cam data variable is registered with *Copy_1_of* added to the front of the name of the cam data variable that was copied.

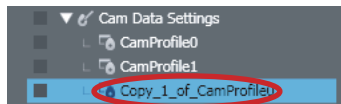

4-1-7 Creating Function Block Instance Variables

- Function Block Instance Variables

When you create an instance of a function block, the function block instance is registered in the local variable table as a data type.

Specify the instance name when you call a function block from another POU.

● Creating Function Block Instance Variables

- Click *Enter Function Block* for the instance of the function block instruction created in the Ladder Editor.

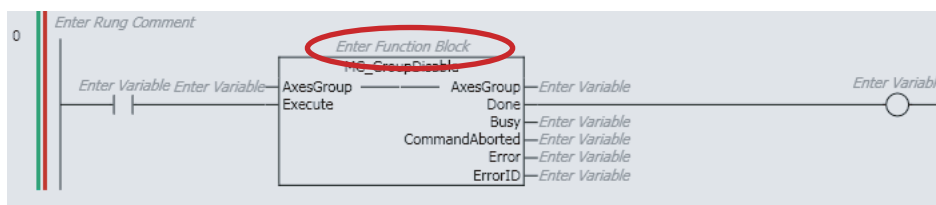

- Enter an instance name and press the Enter Key.

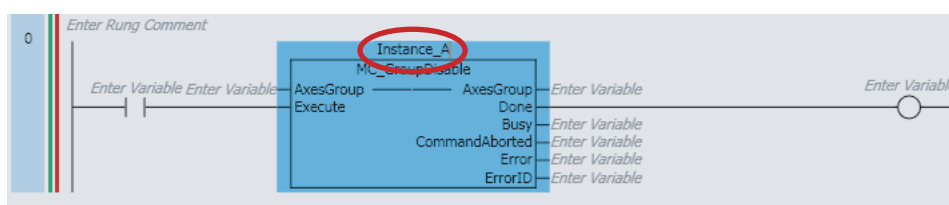

When you set an instance name, the function block instance is registered as an instance variable in the local variable table.

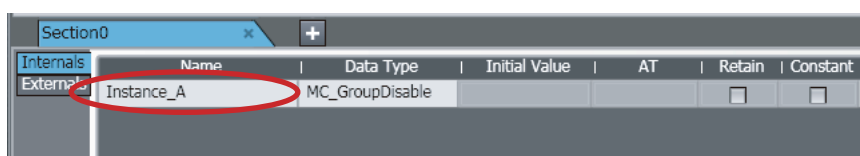

● Editing, Deleting, Copying, and Pasting Function Block Instance Variables

You can edit, delete, copy, and paste function block instance variables with the same procedures as for global variables.

4-1-8 System-defined Variables

- System-defined Variables

System-defined variables are pre-defined by the system. All system-defined variable attributes are fixed.

The names and all other attributes of these variables are defined, and special functions are assigned to them. You cannot change the names or any other attributes.

- You can use system-defined variables as soon as you register the Controller on the Sysmac Studio.
- System-defined variable names start with an underbar, as shown below.

P_CY	BOOL	Carry Flag
P_First_Run	BOOL	First Program Period Flag
P_First_RunMode	BOOL	First RUN Period Flag
P_Off	BOOL	Always FALSE Flag
P_On	BOOL	Always TRUE Flag
P_PRGER	BOOL	Instruction Error Flag
BackupBusy	BOOL	Backup Busy Flag
_Card1Access	BOOL	SD Memory Card Access Flag
_Card1Deteriorated	BOOL	SD Memory Card Life Warning Flag
_Card1Err	BOOL	SD Memory Card Error Flag
_Card1PowerFail	BOOL	SD Memory Card Power Interruption Flag
_Card1PrgTransferCmd	_SPRGTRANSFER_CMD	SD Memory Card Program Transfer Command
_Card1PrgTransferSta	_SPRGTRANSFER_STA	SD Memory Card Program Transfer Status
_Card1Protect	BOOL	SD Memory Card Write Protected Flag
_Card1Ready	BOOL	SD Memory Card Ready Flag
_Card1RestoreCmd	_SRESTORE_CMD	SD Memory Card Restore Command
_Card1RestoreCmdTargetAbsEncoder	BOOL	Absolute Encoder Home Offset Transfer Flag

- You can select them from lists in the Ladder Editor or ST Editor.
- There are system-defined variables for each of the four function modules, as listed in the following table.

Function module	Type of system-defined variable
PLC Function Module	System-defined variables for PLC Function Module
Motion Control Function Module	System-defined variables for motion control
EtherNet/IP Function Module	System-defined variables for EtherNet/IP
EtherCAT Master Function Module	System-defined variables for EtherCAT master

- For information on system-defined variables, refer to **System Defined Variable Reference** on the Help Menu, or to the *NJ/NX-series CPU Unit Software User's Manual (Cat. No. W501)* or *NY-series Industrial Panel PC / Industrial Box PC Software User's Manual (Cat. No. W558)*.

4-1-9 Entering Variable Attributes

This section describes how to enter variable attributes.

The following table shows which attributes exist for different variable types and POUs (programs, functions, and function blocks).

Attributes Supported by Each Type of Variable

Type of variable	Global variables	Programs		Function blocks				
		Internal variables	External variables	Internal variables	Input variables	Output variables	In-out variables	External variables
Name	Supported.	Supported.	Supported.	Supported.	Supported.	Supported.	Supported.	Supported.
Data Type	Supported.	Supported.	Supported.	Supported.	Supported.	Supported.	Supported.	Supported.
Initial Value	Supported.	Supported.	Not supported.	Supported.	Supported.	Not supported.	Not supported.	Not supported.
AT Specification	Supported.	Supported.	Not supported.	Supported.	Not supported.	Not supported.	Not supported.	Not supported.
Retain	Supported.	Supported.	Not supported.	Supported.	Supported.	Supported.	Not supported.	Not supported.
Constant	Supported.	Supported.	Supported.	Supported.	Supported.	Not supported.	Supported.	Supported.
Network Publish	Supported.	Not supported.	Not supported.	Not supported.	Not supported.	Not supported.	Not supported.	Not supported.
Comment	Supported.	Supported.	Supported.	Supported.	Supported.	Supported.	Supported.	Supported.
In/Out	Not supported.	Not supported.	Not supported.	Not supported.	Supported.	Supported.	Supported.	Not supported.
Edge	Not supported.	Not supported.	Not supported.	Not supported.	Supported.	Not supported.	Not supported.	Not supported.

Type of variable	Functions					
	Internal variables	Input variables	Output variables	In-out variables	External variables	Return values
Name	Supported.	Supported.	Supported.	Supported.	Supported.	Supported.
Data Type	Supported.	Supported.	Supported.	Supported.	Supported.	Supported.
Initial Value	Supported.	Supported.	Not supported.	Not supported.	Not supported.	Not supported.
AT Specification	Not supported.	Not supported.	Not supported.	Not supported.	Not supported.	Not supported.
Retain	Not supported.	Not supported.	Not supported.	Not supported.	Not supported.	Not supported.
Constant	Supported.	Supported.	Not supported.	Supported.	Supported.	Not supported.
Network Publish	Not supported.	Not supported.	Not supported.	Not supported.	Not supported.	Not supported.
Comment	Supported.	Supported.	Supported.	Supported.	Supported.	Supported.
In/Out	Not supported.	Supported.	Supported.	Supported.	Not supported.	Not supported.
Edge	Not supported.	Not supported.	Not supported.	Not supported.	Not supported.	Not supported.

For information on attributes, valid value ranges, and character restrictions, refer to the *NJ/NX-series CPU Unit Software User's Manual (Cat. No. W501)* or *NY-series Industrial Panel PC / Industrial Box PC Software User's Manual (Cat. No. W558)*.

● Name Attribute

Name	Data Type	Initial Value	AT	Retain	Constant	Network Publish
aaa	BOOL			<input type="checkbox"/>	<input type="checkbox"/>	Do not publish

Enter a string for the name.

● Data Type Attribute

Data Type	Initial Value
BOOL	
BYTE	
SINT	
USINT	
INT	
UINT	
DINT	
UDINT	
LINT	
ULINT	
WORD	
DWORD	
LWORD	
REAL	

Enter a data type directly or select one from the list.

You can select from the following data types.

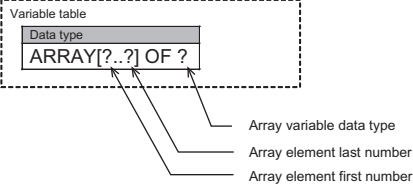
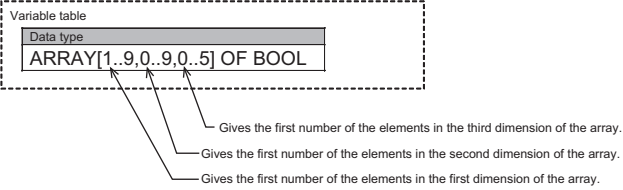
Classification	Data type		Data type name
Basic data types	Boolean		BOOL
	Bit strings		BYTE, WORD, DWORD, and LWORD
	Integers	Signed	SINT, INT, DINT, and LINT
		Unsigned	USINT, UINT, UDINT, and ULINT
	Real numbers		REAL and LREAL
	Durations		TIME
	Dates		DATE
	Times		TIME_OF_DAY
	Date and times		DATE_AND_TIME
	Text strings		STRING[256] After you select <i>STRING[256]</i> as the data type, edit the value inside the brackets to specify the size of the string including the NULL character.
Data type attributes	Array specification	Fixed-length array	<p>ARRAY[?..?] OF ? After you select <i>ARRAY[?..?] OF ?</i> as the data type, edit the question marks as follows:</p>  <p>Example: ARRAY[0..9]OF INT This specifies an array variable that contains 10 INT elements from 0 to 9.</p> <p>Specifying Multi-dimensional Arrays:</p>  <p>If the first array element number is 0, you can enter the variable as follows: Basic_data_type[Number_of_elements] Example: You can enter ARRAY[0..4,0..9] OF BOOL as BOOL[5,10].</p>

Classification	Data type			Data type name	
	Data type attributes	Array specification	Variable-length array*1		
Basic data types				<p>A method for specifying an array with any number of array elements. This array can be used only for in-out variables of a function/function block.*2</p> <ul style="list-style-type: none"> Specifying method <p>Specify the data type as follows. ARRAY[*] OF ?</p> <p>Specify * where each of the array element first number and last number is entered, and specify the data type of the array elements in ?. Example: ARRAY[*] OF BOOL You can enter ARRAY[*] OF BOOL as BOOL[*].</p> <p>For a multi-dimensional array, specify * for each dimension, such as ARRAY[*,*,*] OF BOOL. You cannot mix * and a numerical value to specify the element first number/last number. You can enter ARRAY[*,*,*] OF BOOL also as BOOL[*,*,*].</p>	
			Range specification	<p>You can specify that an integer variable (INT, SINT, DINT, LINT, UINT, USINT, UDINT, and ULINT) contains only values within a certain range.</p> <div style="border: 1px dashed black; padding: 5px; margin: 10px 0;"> <p>Variable Table</p> <table border="1" style="margin: 0 auto;"> <tr> <th>Data type</th> </tr> <tr> <td>INT(10..100)</td> </tr> </table> <p style="text-align: right;">This means that the variable must have a value between 10 and 100, inclusive.</p> <p style="text-align: right;">End point</p> <p style="text-align: right;">Start point</p> </div>	Data type
Data type					
INT(10..100)					
Derivative data types	Structures			Specify a user-defined structure data type or a system-defined structure data type in the Structure group of the Data Type Editor.	
	Unions			Specify a user-defined union data type or a system-defined union data type in the Union group of the Data Type Editor.	
	Enumerations			Specify a user-defined enumerated data type or a system-defined enumerated data type in the Enumerated group of the Data Type Editor.	
POU instances				Specify a system-defined function block name, or a user-defined function block name.	

*1. This setting is supported by CPU Units with unit version 1.18 or later.

*2. For details on how to use variable-length array variables, refer to the *NJ/NX-series CPU Unit Software User's Manual (Cat. No. W501)* or *NY-series Industrial Panel PC / Industrial Box PC Software User's Manual (Cat. No. W558)*.

● Initial Value Attribute

Name	Data Type	Initial Value	AT	Retain	Constant	Network Publish	Com
aaa	BOOL			<input type="checkbox"/>	<input type="checkbox"/>	Do not publish	

Specify a value for the variable for one of the following situations when the Retain attribute is not specified.

- When the power supply is turned ON
- When the operating mode is changed
- When you specify to initialize the value when the program is transferred

Enter a value directly or select an item from the list (the values in the list depend on the data type).

If you do not enter an initial value, 0 is used as the initial value.

Select None for no initial value.

- Initial Values for Union Members: The initial values for union members cannot be edited and are always 0.
- Enter the initial values for the elements of the array variable or the members of the structure variable in the Initial Value Settings Dialog Box.

1 Click the Display Initial Value Settings Dialog Box Button in the initial value entry cell.

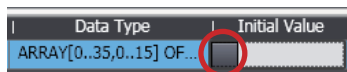

The Initial Value Setting Dialog Box is displayed.

Example: Two-dimensional Structure Array



No.	Item	Description
1	Horizontal subscript display area	The subscripts of the specified dimension are displayed horizontally in order from 0. The array elements of the structure members are all expanded on the display.
2	Vertical subscript display area	The subscripts for the dimension that is not displayed in the horizontal subscript display area are displayed vertically in order from 0. For a three-dimensional array, the subscripts for the two dimensions that are not displayed in the horizontal subscript display area are displayed in combinations in order.
3	Array display direction selection list	Used to select the directions in which to display the array dimensions from a list.

No.	Item	Description
4	Array element jump settings	Used to jump to a specified element. Enter the array subscripts and click the Go to Button to move to the specified element.
5	Change Page	You can scroll the page either vertically or horizontally. Each page displays 26 items vertically and 20 items horizontally. You can scroll the page by half pages or whole pages.
6	Go to Error Button	Jumps to the first initial value error.

In this example, the initial value of the member Struct1[0,0].BoolMem1 is displayed at the intersection of the "[0,*]" row and "[*,0].BoolMem1" column.

- 2** Enter the initial values of the members, and then click the **OK** Button.
The initial values are set.

Data Type	Initial Value
ARRAY[0..35,0..15] OF...	[(BoomMem1 := True, IntM...



Additional Information

- You can change the display format of the Initial Value Settings Dialog Box in the option settings to the format used in Sysmac Studio version 1.06 or lower.

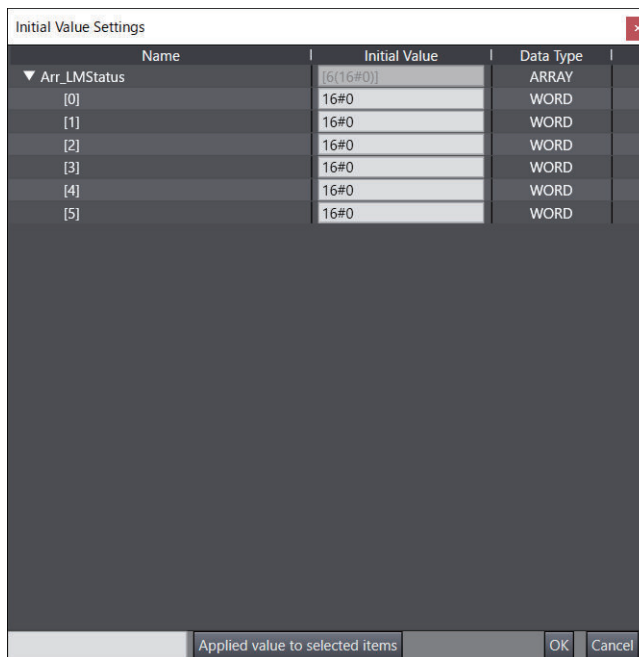

For details on changing the display format, refer to *8-26 Sysmac Studio Option Settings* on page 8-166.

● AT Specification Attribute

Name	Data Type	Initial Value	AT	Retain	Constant	Network Publish	Comr
aaa	BOOL		<input type="checkbox"/>	<input type="checkbox"/>	<input type="checkbox"/>	Do not publish	

- When Specifying an Address in Memory Used for CJ-series Units with an NJ-series Controller: Add a % character to the beginning of the addresses when specifying memory used for CJ-series Units. This is shown in the following table.

Area	Setting range	Format to enter
CIO Area	CIO 0 to CIO 6143	%0 to %6143
Work Area	W000 to W511	%W0 to %W511
Holding Area	H0 to H1535	%H0 to %1535
DM Area	D0 to D32767	%D0 to %D32767
EM Area	E0_0 to E18_32767	%E0_0 to %E18_32767

- For Device Variables Specified in the I/O Map:
The contents of the *AT Fields* of the device variables are displayed automatically.
- When an AT address is specified for axis variables or axes group variables:
When *_sAXIS_REF* or *_sGROUP_REF* is input in the Data Type input area, the button to show AT Setting Dialog Box is displayed in the AT input area.

- 1 Click the button to show AT Setting Dialog Box.

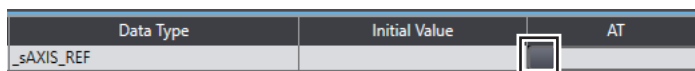

- 2 Select one variable from the list of axis variable or axes group variable group in the AT Setting Dialog Box.

Example for axis variables:

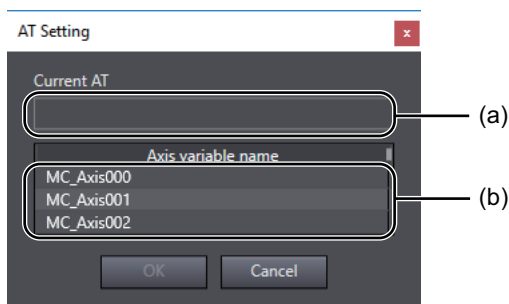

	Item	Description
(a)	Current AT specification	Displays a variable name corresponds to the input AT.
(b)	Variable list	Displays all axis variables that are registered in the axis settings.

- 3 Click the **OK** Button.
The AT specification for axis variables or axes group variables is set.

Data Type	Initial Value	AT
_sAXIS_REF		MC://_MC_AX[0]

● Retain Attribute

Name	Data Type	Initial Value	AT	Retain	Constant	Network Publish	Comr
aaa	BOOL			<input type="checkbox"/>	<input type="checkbox"/>	Do not publish	

Specify whether to retain the value of the variable in the following cases.

- When power is turned ON after a power interruption
- When the operating mode changes to RUN mode

- When programs are transferred from the computer to the Controller

Select the check box when you want to retain the values.

Refer to the *NJ/NX-series CPU Unit Software User's Manual (Cat. No. W501)* or *NY-series Industrial Panel PC / Industrial Box PC Software User's Manual (Cat. No. W558)* for details on the conditions for retention of the retained variables.

● **Constant Attribute**

Name	Data Type	Initial Value	AT	Retain	Constant	Network Publish	Comr
aaa	BOOL			<input type="checkbox"/>	<input type="checkbox"/>	Do not publish	

- If you set the Constant attribute, you can set the initial value of the variable when it is downloaded, but you cannot overwrite the value afterward.

● **Network Publish Attribute (Global Variables Only)**

Name	Data Type	Initial Value	AT	Retain	Constant	Network Publish	Comment
aaa	BOOL			<input type="checkbox"/>	<input type="checkbox"/>	Do not publish	

Select the setting for the Network Publish attribute from the list. You can select from the following.

Network Publish attribute setting		Description
Do not publish		The variable cannot be accessed from external devices. However, Support Software can still access the variable regardless of this setting.
Publish	Publish Only	You can access a variable with this attribute from external devices through CIP communications. Tag data links are not possible for variables with this attribute setting.
	Input	You can access a variable with this attribute from external devices through CIP communications or a tag data link. For tag data links, this will be a variable for data input (from another Controller to the local Controller).
	Output	You can access a variable with this attribute from external devices through CIP communications or a tag data link. For tag data links, this will be a variable for data output (from the local Controller to another Controller).

● **In/Out Attribute (Input/Output Variable Group Only)**

Name	In/Out	Data Type	Edge	Initial Value	Retain	Constant	Comment
test_in	Input	BOOL	No Edge		<input type="checkbox"/>	<input type="checkbox"/>	

For the input/output variable group used in functions or function blocks, specify either an input variable, output variable, or in-out variable from the list.

● Edge (Input/Output Variable Group Only)

Name	In/Out	Data Type	Edge	Initial Value	Retain	Constant	Comment
test_in	Input	BOOL	No Edge No Edge Up Down		<input type="checkbox"/>	<input type="checkbox"/>	

The Edge attribute makes a BOOL variable pass TRUE to a function block when the variable changes from FALSE to TRUE or when it changes from TRUE to FALSE.

This attribute is for function block input variables only.

Select an attribute setting from the list. You can select from the following.

Edge attribute setting	Description
No edge	No edge
Up	FALSE to TRUE
Down	TRUE to FALSE

● Comment Attribute

Name	Data Type	Initial Value	AT	Retain	Constant	Network Publish	Comment
aaa	BOOL			<input type="checkbox"/>	<input type="checkbox"/>	Do not publish	

Enter a comment.

- Use the following procedure to enter the comments for the elements of an array variable or the comments for structure variable members in the Comment Settings Dialog Box. (The array variable can be a member of a union.)

- 1 Click the Display Comment Settings Dialog Box Button in the comment entry cell.



The Comment Settings Dialog Box is displayed.



- 2 Enter the comments for the elements and then click the **OK** Button.
This completes entering the comments.



Precautions for Correct Use

- If you select the **Use global variable comment** Check Box in the option settings, you cannot edit the comments for the corresponding variables that are registered as external variables in the local variable tables.
- You can register comments for union variables or for array elements in union array variables with Sysmac Studio version 1.07 or higher. However, if you open a project in which such comments are registered on Sysmac Studio version 1.06 or lower and then open the Comment Settings Dialog Box for the union variable or union array variable, the comments for the array elements will be lost.
- You can register comments for structure variable members and for array elements of structure array variables with Sysmac Studio version 1.09 or higher. However, if you open a project with such comments on Sysmac Studio version 1.08 or lower, you cannot edit the variable comments. Also, if you open a project in which such comments are registered on Sysmac Studio version 1.06 or lower and then open the Comment Settings Dialog Box for the structure variable or structure array variable, the comments for the structure variable members or array elements will be lost.
- If you register a comment for a structure variable member and then change the name of the member, the variable comment is cleared.
- For a variable-length array variable, you cannot enter a comment for an array element.



Additional Information

- You can globally switch the comments that are displayed. Also, you can edit the display comments and switchable comments simultaneously from a variable table. Refer to *8-17 Changing Variable Comments and Data Type Comments* on page 8-140 for the actual procedures.
- You can expand and close more than one level of elements and members displayed for array variables and structure variables. Right-click a variable, element, or member and select **Expand All under the Selected Item** or **Collapse All under the Selected Item**.
- You can also display the Comment Settings Dialog Box online. Select a variable from the variable table and right-click to select **Show Comment Setting Dialog** from the pop-up menu.

Exporting/Importing Variable Comments

Export variable comments into an Office Open XML format file (xlsx format file). The comments to be exported include structure variable member comments, union variable member comments, and array variable element comments (hereinafter called “element comments”). You can edit a file with exported comments in spreadsheet software that supports the Office Open XML format such as Excel. You can import an edited file and change the variable comments at a time. This is useful when you register comments, in addition to definitions, for structure variable members and for union variable and array variable elements.

Comments are exported to a file in units of the following variables.

- Global variable
- Internal variable
- In-out variable
- External variable

● Exporting Comments

- 1 Right-click in the view of the variable table that has the variable element comments you want to edit, and select **Export comment – Selected variables (including element comments)** or **All variables in this view (including element comments)** from the menu.

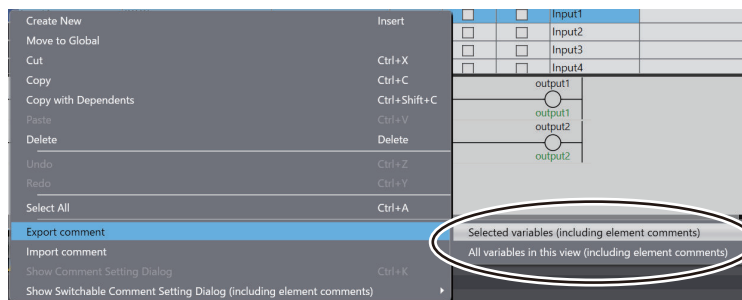

The Save File Dialog Box is displayed.

- 2 Enter the file name, and then click the **Save** Button.
The comments for the target variables are saved in an xlsx format file.



Additional Information

- The maximum number of rows is 65,536 for comments to be output to an xlsx format file. If the number of rows is 65,536 or greater, comments are divided and exported into multiple files that are serial-numbered automatically.
- Variable comments that are not displayed on screen due to the filtering function are not exported.

● Editing Comments

Use the following procedure to edit the xlsx format file that you exported.

- 1 Open the xlsx file in a spreadsheet software application.
- 2 Edit a comment.

You can add comments to variables and elements without comments. To delete an existing comment, make the cell containing it blank.

	A	B	C
1	Sysmac Studio Element Comments File	Name	Comment
2		max_elements_array	root
3		max_elements_array[0]	comment of 0
4		max_elements_array[1]	comment of 1
5		max_elements_array[2]	
6		max_elements_array[3]	
7		max_elements_array[4]	
8		max_elements_array[5]	

Do not change the first row (header row) or data in the name column.

3 Save the file.



Additional Information

You can edit an xlsx format file with spreadsheet software that supports the Office Open XML format such as Excel 2007 or later.

● Importing Comments

Use the following procedure to import the xlsx format file that you edited to the original variable table.

1 Right-click the target variable table and select **Import comment** from the pop-up menu.

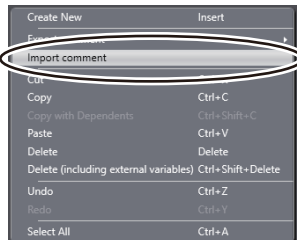

The Select File Dialog Box is displayed.

2 Select the xlsx format file to import, and then click the **Open** Button. When comments were divided and exported into multiple files, select all the files. The import operation starts.



Precautions for Correct Use

You cannot import the data while the filtering function is used. Cancel the filtering function, and then execute the import operation.

4-1-10 Variable Manager

- The Variable Manager displays a list of the variables in the global or in a local variable table in a separate window.

- You can display variable usage, sort and filter the variables, edit and delete variables, or move variables while displaying another editing view.

Starting the Variable Manager

- Select **Variable Manager** from the **View** Menu.

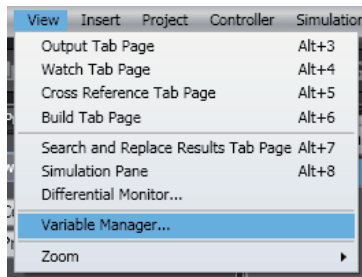

The Variable Manager Window is displayed.

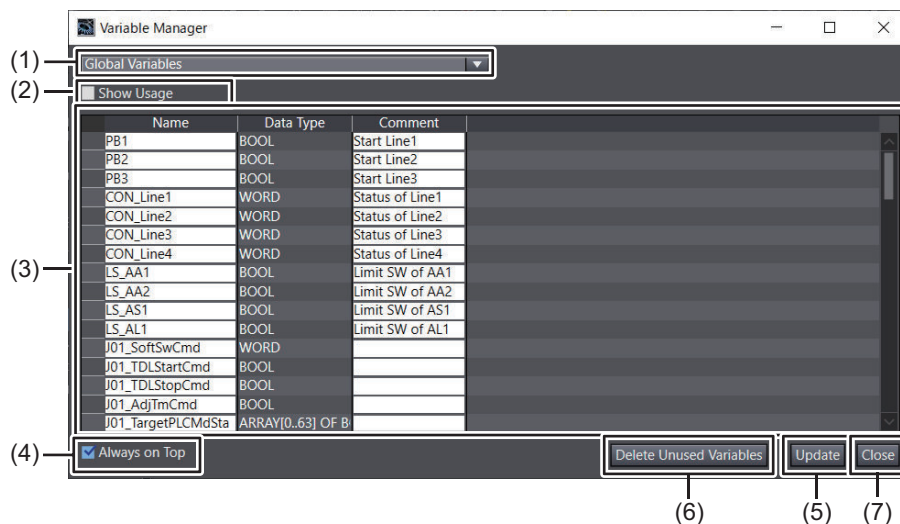

Parts of the Window

No.	Part	Description
1	Variable table selection box	Use this box to select the variable table to display.
2	Show Usage Check Box	Select this check box to display columns of the usage of the variables in the variable list. Clear the selection to hide the usage columns.
3	Assigned variable list	This list displays the variables from the variable table that is selected in the variable table selection box. You can display and hide columns from the pop-up menu.
4	Always on Top Check Box	Select this check box to always display the Variable Manager Window on top of other windows and dialog boxes.
5	Update Button	Click this button update the display to reflect any changes that have been made to the source variable table.
6	Delete Unused Variables Button	Click this button to delete all variables that are not used in any program from all of the variable tables in the Controller.

No.	Part	Description
7	Close Button	Click this button to close the Variable Manager Window.

- 2 Select the variable table to display in the variable table selection box.
The current contents of the variable table are displayed in the variable list.

Displaying Variable Usage

You can display the number of locations in which each variable is used. You can also search for the variables that are not used at all as unused variables.

- 1 Select the **Show Usage** Check Box in the Variable Manager Window.
The usage columns are displayed in the variable list.

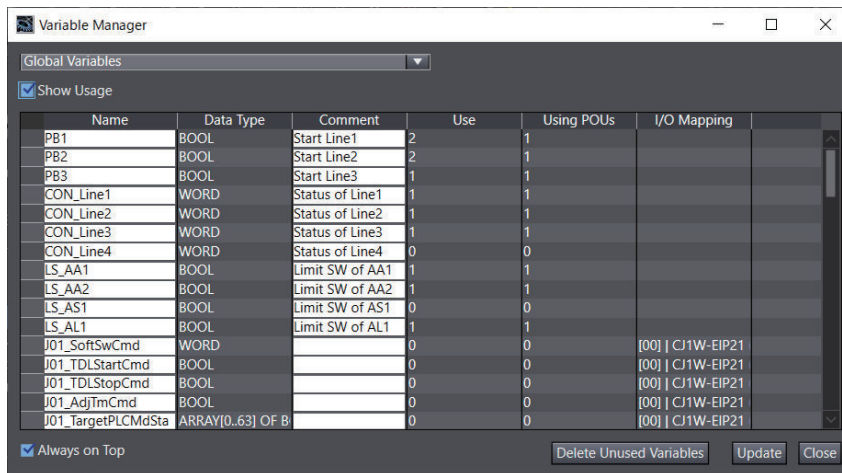

Displayed Columns

Column	Description
Use	The number of locations in which each variable is used is displayed.
Using POUs	The number of POUs in which each variable is used is displayed. (This is displayed for global variables.)
I/O Mapping	If a variable is assigned to I/O, the I/O name is displayed. (This is displayed for global variables and internal variables.)

- 2 Clear the **Show Usage** Check Box to hide the usage columns.

Sorting Variables

You can sort the variable table in ascending or descending order according to any column.

- 1 Click the title row cell for the column to use to sort the variable list.

Name	Data Type	Comment
PB1	BOOL	Start Line
PB2	BOOL	Start Line2
PB3	BOOL	Start Line3
CON_Line1	WORD	Status of Line1
CON_Line2	WORD	Status of Line2
CON_Line3	WORD	Status of Line3
CON_Line4	WORD	Status of Line4
LS_AA1	BOOL	Limit SW of AA1
LS_AA2	BOOL	Limit SW of AA2
LS_AS1	BOOL	Limit SW of AS1
LS_AL1	BOOL	Limit SW of AL1
J01_SoftSwCmd	WORD	
J01_TDLStartCmd	BOOL	
J01_TDLStopCmd	BOOL	
J01_AdjTrmCmd	BOOL	
J01_TargetPLCMdSt	ARRAY[0..63] OF BC	
J01_TargetPLCErrSt	ARRAY[0..63] OF BC	
J01_UnitSta1	WORD	
J01_UnitSta2	WORD	
J01_CommSta1	WORD	
J01_CommSta2	WORD	
J01_CommSta3	WORD	
J01_RegTargetSta	ARRAY[0..63] OF BC	

The variable list will be sorted in ascending order of the column.

Name	Data Type	Comment
J01_EstbTargetSta	ARRAY[0..63] OF BC	
J01_TargetPLCErrSt	ARRAY[0..63] OF BC	
J01_TargetPLCMdSt	ARRAY[0..63] OF BC	
J01_RegTargetSta	ARRAY[0..63] OF BC	
J01_DNSSvrErr	BOOL	
J01_IPRouterTblErr	BOOL	
J01_IPAdrTblErr	BOOL	
J01_BootpSvrErr	BOOL	
J01_ETNAdvSetErr	BOOL	
J01_RTblErr	BOOL	
J01_TagRefreshErr	BOOL	
J01_TagDbErr	BOOL	
J01_CommParamErr	BOOL	
J01_TDLOpnErr	BOOL	
J01_TDLerr	BOOL	
J01_LkSta	BOOL	
J01_ETNBaseSetErr	BOOL	
J01_FTPSta	BOOL	
J01_TDLAllRunSta	BOOL	
J01_TDLRunSta	BOOL	
J01_SNTPSvrErr	BOOL	
J01_FINSTCPCConnS	BOOL	
J01_FINSTCPCConnS	BOOL	

Filtering Variables

You can apply a filter to the variable list to display only specific variables.

- 1 Right-click the title row cell for the column to use to filter the variable list and select **Filtering**.



The Filtering Dialog Box is displayed.

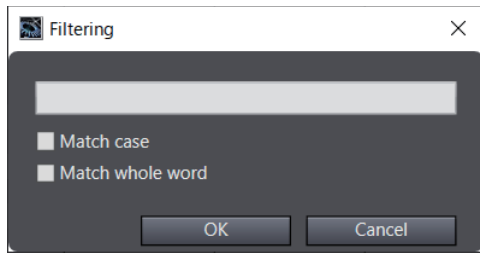

- 2 Enter a text string to use for filtering in the text box, specify the condition, and click the **OK** Button.

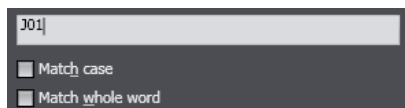

The variables that meet the specified condition are displayed in the variable list.

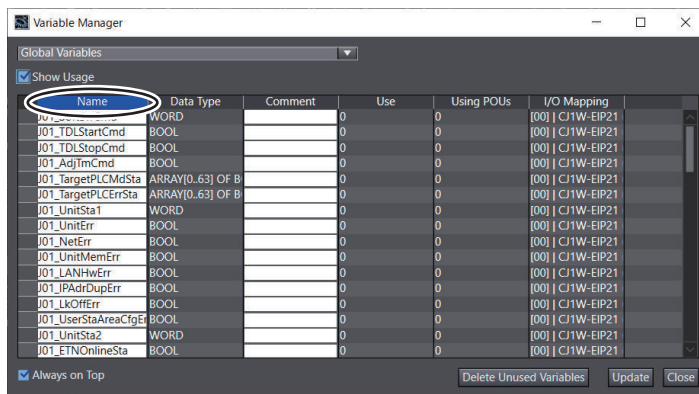

- 3 To cancel filtering, right-click the title row cell for the column that you used to filter the variable list and select **Clear Filtering**.

Editing, Copying, and Deleting Variables

For any variable that can be edited on the Variable Manager, you can change the variable name or comment or you can delete the variable.

● Editing Variables

- 1 In the variable list, double-click the name or comment of a variable that can be edited or press the F2 + Tab Keys to select the item to edit.

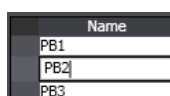

After you change the name or comment, press the Enter Key to apply the change. The change is also applied to the source variable table.

Name	Data Type
PB1	BOOL
PB5	BOOL
PB3	BOOL

If you change the name of a variable, a confirmation dialog box is displayed that asks whether to change the name of the variable in the programs.

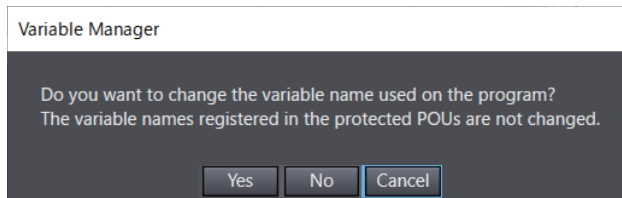

Click the **Yes** Button to change the name in the programs.

● Copying Variables

- 1 Right-click the variable to copy in the variable list and select **Copy** from the pop-up menu.

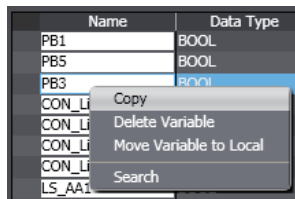

Select the variable table into which to paste the variable and paste the variable.
The variable is pasted.

● Deleting Variables

- 1 Right-click the variable to delete in the variable list and select **Delete** from the pop-up menu.

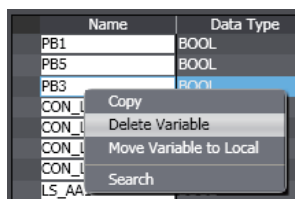

The selected variable is deleted. The variable is also deleted from the source variable table.



Precautions for Correct Use

- When you change or delete a variable in the Variable Manager, the change is applied directly to the global variable table and local variable tables. You cannot undo this operation.
- If the results of editing a variable causes an error for that variable, the error is detected in the source variable table. Error checking is not performed in the Variable Manager.
- Even if the contents of the global variable table or the local variable table that is displayed in the Variable Manager is changed, the change is not shown in the Variable Manager. If you attempt to change, copy, or delete a variable that no longer exists, an error message is displayed.
- To apply any changes that have been made in the global variable table or the local variable table, click the **Update** Button in the Variable Manager.

Moving Variables

You can move a global variable or local variable to a local variable table or to the global variable table. By moving a variable to the appropriate variable table according to the usage conditions of the variable, you can make POU's easier to reuse.

● Moving a Global Variable to a Local Variable Table

- 1 If a variable is used only in one POU, right-click the variable in the variable list and select **Move Variable to Local** from the pop-up menu.

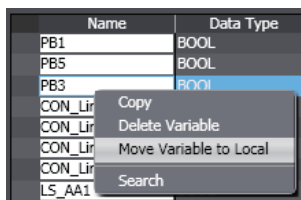

The selected variable is moved to the internal variables of the POU and it is deleted from the global variable table.

The corresponding variable that is registered in the external variables of the POU is also deleted.

● Moving a Local Variable to the Global Variable Table

- 1 Right-click the variable to move in the variable list and select **Move Variable to Global** from the pop-up menu.

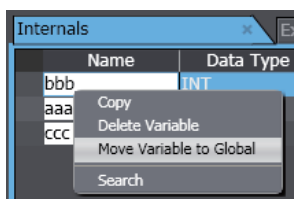

The selected variable is moved to the global variable table and it is deleted from the local variable table.

The variable that was moved is automatically registered as an external variable in the local variable table.



Precautions for Correct Use

- If the POU does not exist or if there are two or more POUs when you attempt to move a global variable to a local variable table, an error will occur and you cannot move it.
- To update the display in the Variable Manager for the results of moving a variable, select the variable table in the variable table selection box or click the **Update** Button.

Searching Variables

You can search for variables in the variable list.

- 1 Right-click anywhere in the variable list and select **Search** from the menu.

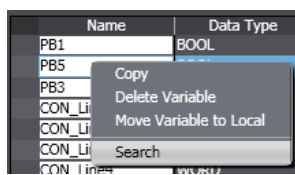

The Search Dialog Box is displayed.

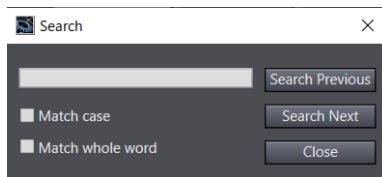

- 2 Enter the search string and click the **Search Previous** or **Search Next** Button.
The display will move to the location in the variable list that matches the search condition.

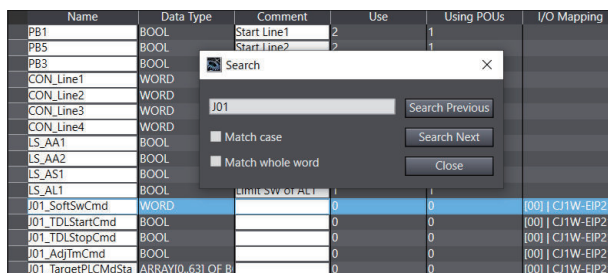

Deleting Unused Variables

You can delete all variables that are not used in any program (i.e., unused variables) from all of the variable tables in the Controller.

- 1 Click the **Delete Unused Variables** Button in the Variable Manager Window.
The following confirmation message is displayed.

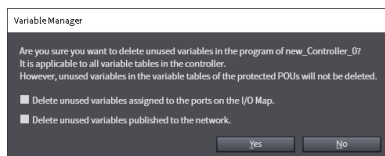

Item	Description
Delete unused variables assigned to the ports on the I/O Map.	Select this check box to delete unused variables assigned to the ports on the I/O Map.
Delete unused variables published to the network.	Select this check box to delete unused variables published to the network.

Select the check boxes, if necessary.

- 2 Click the **Yes** Button.
The unused variables are deleted.

4-2 Registering POUs

- POUs (Program Organization Units)

A POU is a unit used to build a program. A POU can be a program, function, or function block. Refer to the *NJ/NX-series CPU Unit Software User's Manual (Cat. No. W501)* or *NY-series Industrial Panel PC / Industrial Box PC Software User's Manual (Cat. No. W558)* for more information.

You begin by first registering a program, function, or function block under **Programming - POUs** in the Multiview Explorer, and then coding the POU.

4-2-1 Displaying POUs

Click **POUs** under **Programming** in the Multiview Explorer.

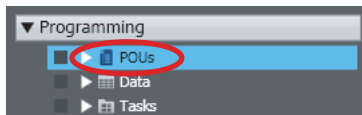

Programs, Functions, and Function Blocks are displayed under POUs.

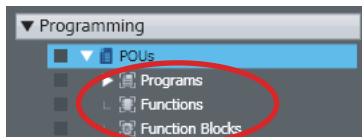

4-2-2 Registering Programs

- Registering Programs

You must create programs that define the control operations. You can design programs as ladder diagrams or ST, and then assign them to tasks for execution. You can use functions and function blocks in programs.

For a detailed explanation of programs, refer to the *NJ/NX-series CPU Unit Software User's Manual (Cat. No. W501)* or *NY-series Industrial Panel PC / Industrial Box PC Software User's Manual (Cat. No. W558)*.

● Registering Ladder Diagram Programs

- 1 Right-click **Programs** under **Programming - POUs** and select **Add - Ladder** from the menu.

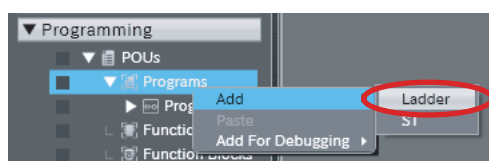

A program with the name Program1 is added (along with a section) under the **Programs** Layer. Program0 is registered in advance.

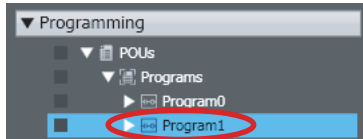

- 2 Double-click the section.

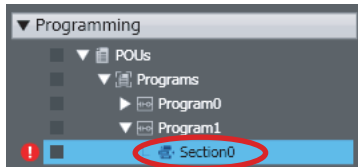

The variable table and Ladder Editor are displayed in the Edit Pane. From here you can create local variables and create ladder diagram rungs.

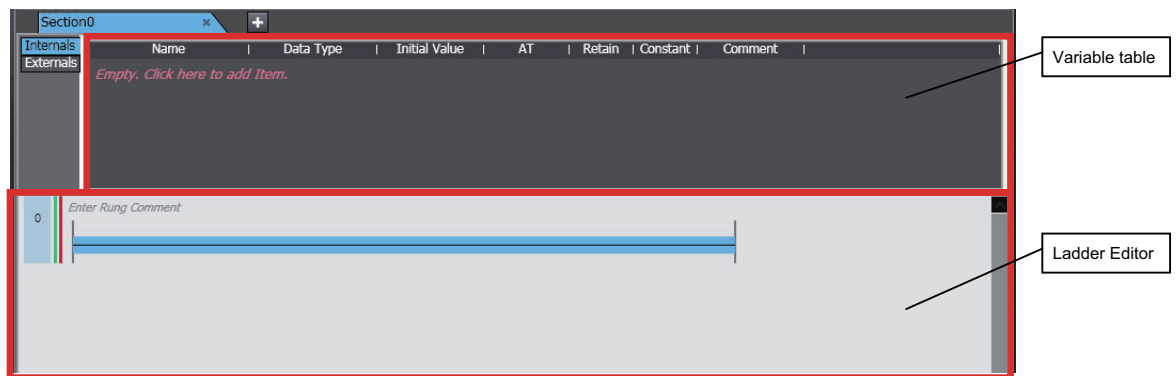

Additional Information

To add a new section, right-click the ladder diagram program and select **Add - Section** from the menu.

● Registering ST Programs

- 1 Right-click **Programs** under **Programming - POUs** and select **Add - ST** from the menu.

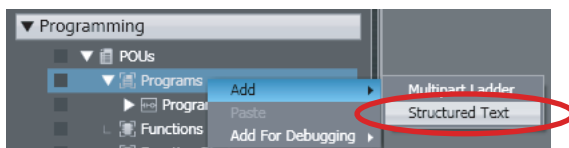

Program1 is added under **Programs**. (ST programs do not have sections.) Program0 for a ladder diagram is registered in advance.

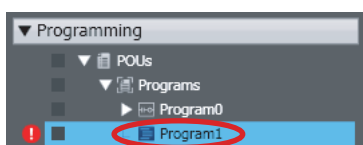

- 2 Double-click the ST program.

The variable table and ST Editor are displayed in the Edit Pane. From here you can create local variables and create ST statements.

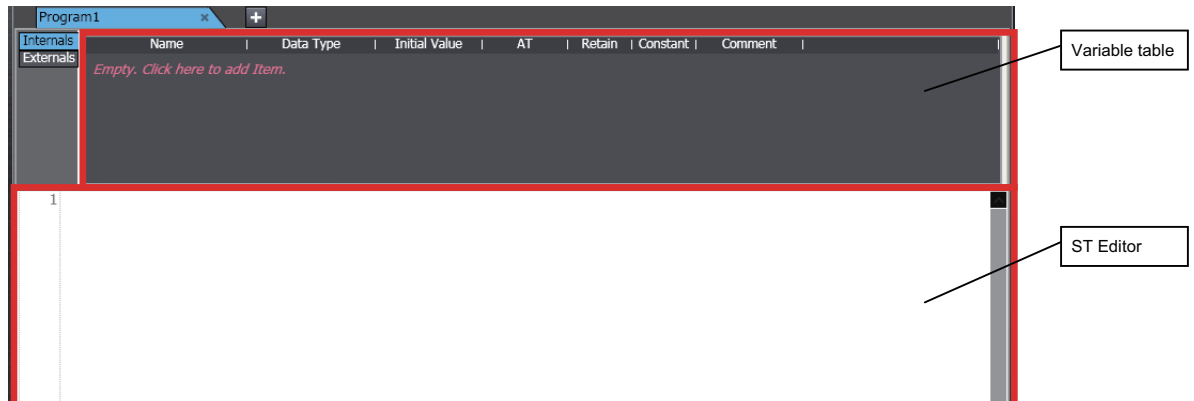

● Deleting Programs

- 1 Right-click the program to delete in the Multiview Explorer and select **Delete** from the menu. A deletion confirmation dialog box is displayed.

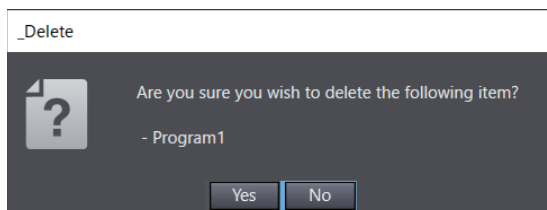

Click the **Yes** Button.
The program is deleted.

● Copying and Pasting Programs

There are the following ways to copy programs.

- **Copy:** Only data under the selected program is copied.
- **Copy with Dependents:** Not only the data under the selected program but also variables that are referenced by the program and the data types of the variables are also copied.

- 1 Select the program to copy in the Multiview Explorer and press the Ctrl+C Keys. Or, right-click the program and select **Copy** from the menu. If you want to copy data together with variables that are referenced by the program and the data types of the variables, select **Copy with Dependents**.

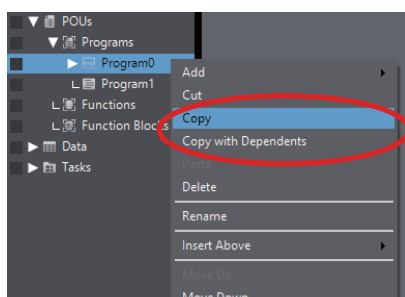

The program is copied.

- 2 Select **Programs** in the Multiview Explorer and press the Ctrl+V Keys. Or, right-click Programs and select **Paste** from the menu.

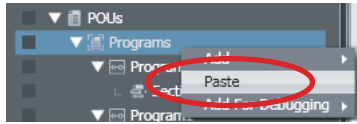

- When **Copy** is selected
The copied program is registered with the name *Copy_1_of_Program Name*.
Local variables and data in the program are also registered at the same time.

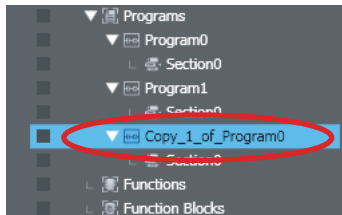

- When **Copy with Dependents** is selected
Not only the data that are copied with **Copy** but also referenced global variables and their data types are pasted.
If a variable or data type with the same name and different attribute already exists, the **Comparison before pasting dependents** Dialog Box is displayed.
For details on the **Comparison before pasting dependents** Dialog Box, refer to *4-7 Comparison before Pasting Dependents* on page 4-166.
You can copy and paste more than one program at the same time. Refer to *4-2-5 Copying, Pasting, and Deleting Multiple POU's* on page 4-64 for details.



Precautions for Correct Use

- When you delete a program, all local variables in that program and section data are deleted with it.
- After you paste a program, check to be sure that the variables and data types are used correctly.



Additional Information

- You can change the name of a program or section. Right-click the section or program to rename and select **Rename** from the menu.
- If you copy and paste a program from a different project when the same name already exists, you can select whether to overwrite or copy.
- You can insert a program between two programs. Right-click the program just after the location where you want to insert the program and select **Insert Above - Ladder** or **Insert Above - ST**.

4-2-3 Registering Function Blocks

- Function Blocks

Function blocks are instructions that define operations. Function blocks are written as ladder diagrams or ST. You can call them from programs as required. You can use functions inside function blocks.

For a detailed explanation of function blocks, refer to the *NJ/NX-series CPU Unit Software User's Manual (Cat. No. W501)* or *NY-series Industrial Panel PC / Industrial Box PC Software User's Manual (Cat. No. W558)*.

● Registering Function Blocks

The following procedure shows how to register a user-defined function block. A ladder function block is used as an example.

Function block instructions are registered in the Sysmac Studio in advance. You do not need to register function block instructions to use them.

You can register ST function blocks in the same way.

- 1 Right-click **Function Blocks** under **Programming - POU's** in the Multiview Explorer and select **Add - Ladder** from the menu.

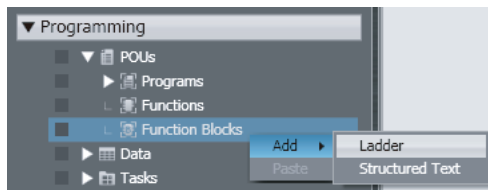

A function block named **FunctionBlock0** is added under **Function Blocks**.

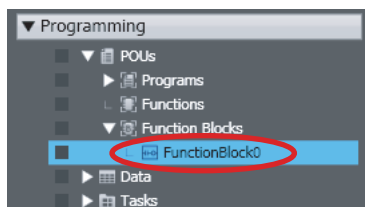

- 2 Double-click the new function block.

The variable table for the function block and Ladder Editor are displayed in the Edit Pane. From here you can create local variables and create ladder diagram rungs.

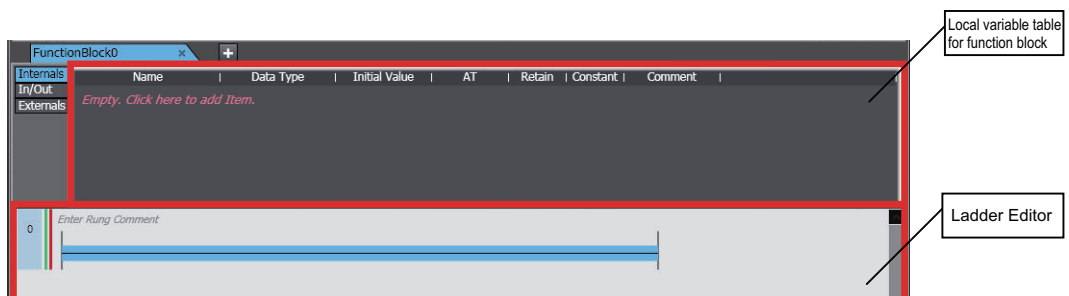

● Deleting, Copying, and Pasting Function Blocks

You can delete, copy, and paste function blocks with the same procedures as for programs.



Precautions for Correct Use

- To use a user-created function block definition in a ladder program, register at least one BOOL input variable and one BOOL output variable in the function block definition. An error will occur if you use a function block definition that does not have BOOL input and output variables in a ladder program.
- When you delete a function block, all local variables and data in that function block are deleted with it.



Additional Information

- You can also insert a function block between two function blocks. Right-click the function block just after the location where you want to insert the function block and select **Insert Above - Ladder** or **ST**.
- After you use a function block in a program (that is, after you have created an instance), you can use that function block as a local variable data type for that program.

4-2-4 Registering Functions

- Functions

A function is an instruction that performs a single function. Functions are written as ladder diagrams or ST. You can call them from programs or function blocks as required.

For a detailed explanation of functions, refer to the *NJ/NX-series CPU Unit Software User's Manual (Cat. No. W501)* or *NY-series Industrial Panel PC / Industrial Box PC Software User's Manual (Cat. No. W558)*.

● Registering Functions

The following procedure shows how to register a user-defined function. A ladder function is used as an example.

Function instructions are registered in the Sysmac Studio in advance. You do not need to register function instructions to use them.

You can register ST functions in the same way as described in this example.

- 1 Right-click **Functions** under **Programming - POUs** in the Multiview Explorer and select **Add - Ladder** from the menu.

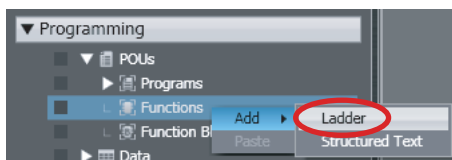

A function named Function0 is added under **Functions**.

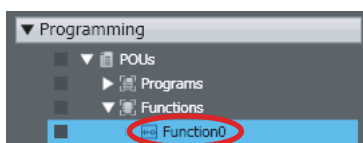

- 2 Double-click the new function.

The variable table for the function and Ladder Editor are displayed in the Edit Pane. From here you can create local variables and create ladder diagram rungs.

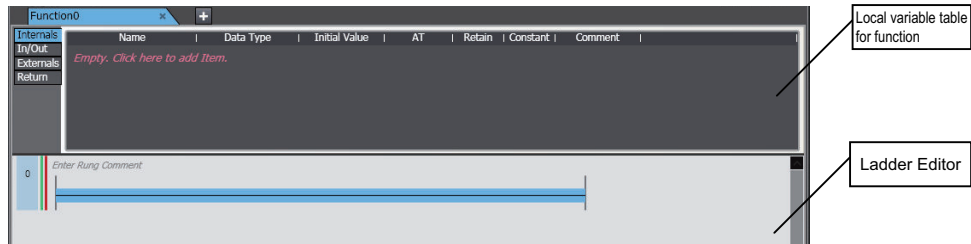

● Deleting, Copying, and Pasting Functions

You can delete, copy, and paste functions with the same procedures as for programs.



Precautions for Correct Use

- To use a user-created function definition in a ladder program, register at least one BOOL input variable and one BOOL output variable in the function definition. An error will occur if you use a function definition that does not have BOOL input and output variables in a ladder program.
- When you delete a function, all local variables and data in that function are deleted with it.



Additional Information

- You can also insert a function between two functions. Right-click the function just after the location where you want to insert the function and select **Insert Above - Ladder** or **ST**.

Displaying Properties

The properties of the POU are displayed. Use the following procedure to set the POU name, namespace, version, and other POU properties.

- 1 Right-click the POU and select **Properties** from the menu.
The Properties Dialog Box for the POU is displayed.

You can change the following items.

Item	Description
Name	Displays the name that is currently set for the POU.

Item	Description
Namespace*1	Displays the namespace that is currently set. If this field is blank, the name is set as a global namespace.
Version*2	Displays the major and minor versions of the POU.
Author*2	Displays the name of the person that created the POU. If this is the first time you are creating a POU after installing the Sysmac Studio, the user name that you entered when you logged onto Windows is displayed.*3
Comment*2	Displays the comment for the POU.

*1. Refer to *4-4 Namespaces* on page 4-79 for information on namespaces.

*2. The items that you enter here are displayed at the bottom of the Toolbox to describe the library object when the function or function block is reused as a library object. Refer to *9-3 Creating and Using Libraries* on page 9-8 for information on library objects.

*3. You can change the author name that is displayed when you create a POU. Change it in the option settings. For details, refer to *8-26 Sysmac Studio Option Settings* on page 8-166.

4-2-5 Copying, Pasting, and Deleting Multiple POUs

You can copy, paste, and delete multiple POUs (programs, functions, or function blocks) at the same time.

Copying and Pasting Multiple POUs

You can select multiple POUs on the selection dialog box, and copy and paste them together.

● Copying Multiple POUs

Select the POUs you want to copy on the **Select and Copy Multiple POUs** Dialog Box.

- 1 Right-click one of the following items in the Multiview Explorer and select **Select and Copy Multiple Items** from the menu.

Item	Select and Copy Multiple Items option
POU	Available
Programs	Available
Ladder programs	Available
Section	Not available
ST programs	Available
Function Blocks	Available
Ladder programs	Available
ST programs	Available
Functions	Available
Ladder programs	Available
ST programs	Available

The figure below shows what are displayed on the menu when you right-click **POUs**, as an example.

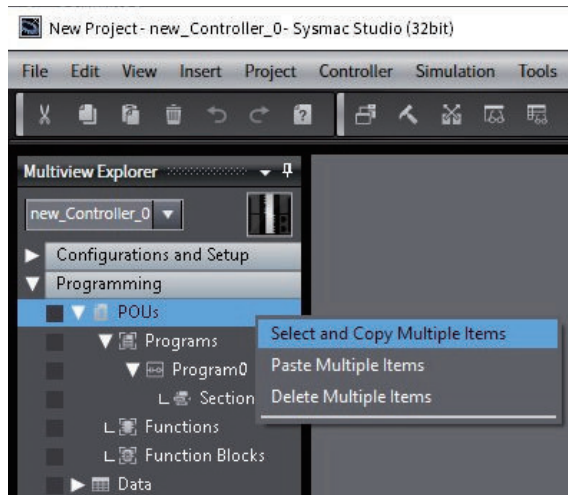

The **Select and Copy Multiple POUs** Dialog Box is displayed.

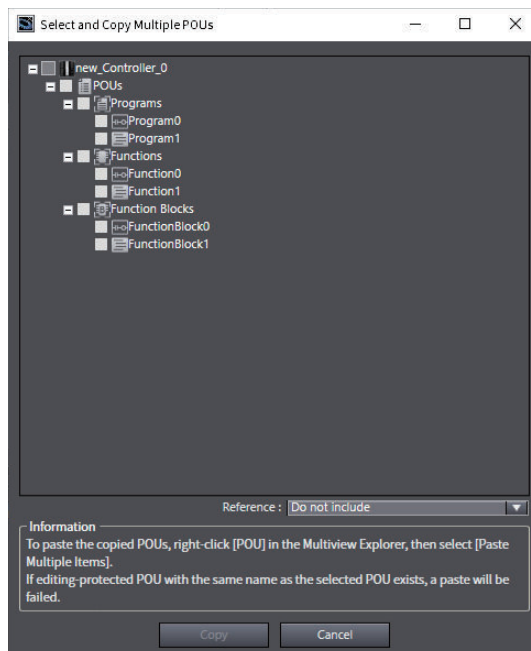

- 2** Select the check boxes for the POUs you want to copy in the tree displayed on the **Select and Copy Multiple POUs** Dialog Box.

In addition, select whether or not to include in the copy the variables and data types referenced by the selected POUs.

Item selected in Reference	Description
Do not include	Copies the selected POUs only.
Include global variable and data type	Includes in the copy the global variables and data types referenced by the selected POUs.
Include POU, global variable, and data type	Includes in the copy the functions, function blocks, global variables, and data types referenced by the selected POUs.

- 3** Click the **Copy** Button.

The selected POUs and the referenced items are copied to the clipboard.

● Pasting Multiple Variables

After you copy multiple POUs, paste the copied POUs.

- 1 Right-click **POUs** in the Multiview Explorer and select **Paste Multiple Items** from the menu.

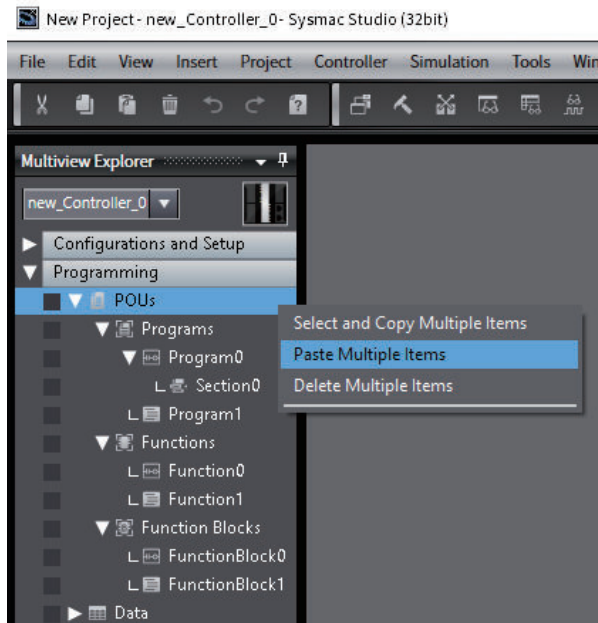

If there is unsaved data in the project when you select **Paste Multiple Items**, a message box appears to confirm whether you want to save the project.

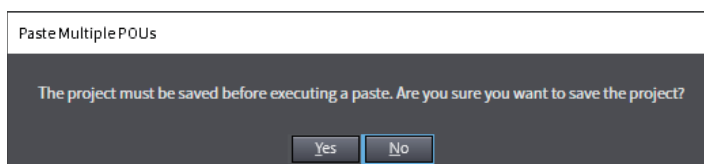

If a POU with the same name exists in the destination, the copied program is pasted with "Copy_1_of_" added to the front of its program name.

If you select an item other than **Do not include in Reference** in the **Select and Copy Multiple POUs** Dialog Box, the following occurs.

- When the POUs were copied with **Include global variable and data type** selected in **Reference**
 Not only the selected POUs but also referenced global variables and data types are registered.
 If a variable or data type with the same name and different attribute already exists, the **Comparison before pasting dependents** Dialog Box is displayed.
 For details on the **Comparison before pasting dependents** Dialog Box, refer to *4-7 Comparison before Pasting Dependents* on page 4-166.
- When the POUs were copied with **Include POU, global variable, and data type** selected in **References**
 Not only the selected POUs but also referenced functions, function blocks, global variables, and data types are registered. If a global variable or data type with the same name and different attribute already exists, the **Comparison before pasting dependents** Dialog Box is displayed.

For details on the **Comparison before pasting dependents** Dialog Box, refer to *4-7 Comparison before Pasting Dependents* on page 4-166.



Precautions for Correct Use

After you paste the POU's, make sure that you can use the variables and data types without problems.



Additional Information

If you copy and paste multiple POU's to a different Controller at the same time, you can select whether to overwrite or make copies of all existing POU's.

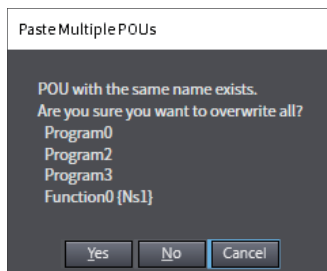

Deleting Multiple POU's

You can select and delete multiple POU's at the same time on a dialog box.

● Deleting Multiple POU's

Select the POU's you want to delete on the **Delete Multiple POU's Dialog Box**.

- 1 Right-click one of the following items in the Multiview Explorer and select **Delete Multiple Items** from the menu.

Item	Delete Multiple Items option
POU's	Available
Programs	Available
Ladder programs	Available
Section	Not available
ST programs	Available
Function Blocks	Available
Ladder programs	Available
ST programs	Available
Functions	Available
Ladder programs	Available
ST programs	Available

The figure below shows what are displayed on the menu when you right-click **POU's**, as an example.

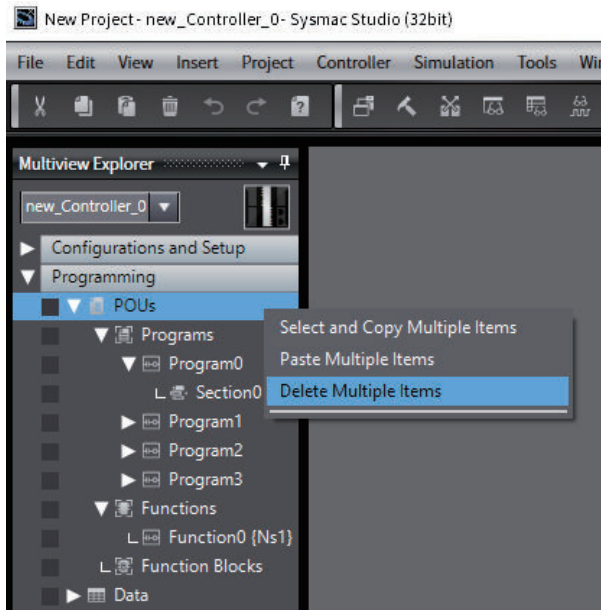

The **Delete Multiple POU**s Dialog Box is displayed.

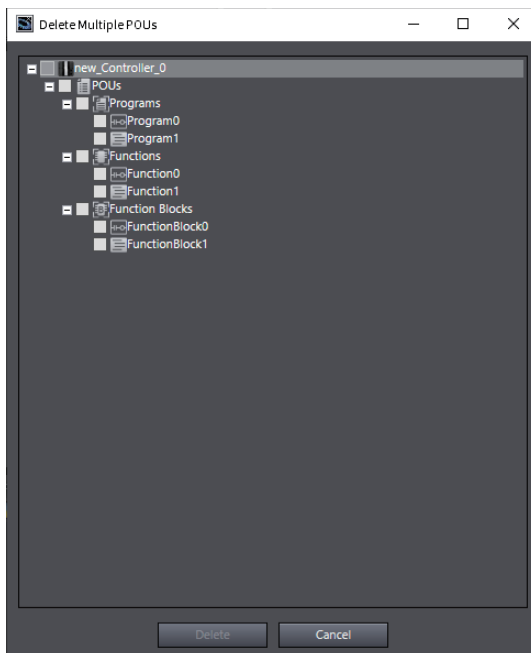

- 2** Select the check boxes for the POU you want to delete in the tree displayed on the **Delete Multiple POU's** Dialog Box.

A message box appears to confirm whether you want to delete the POU's.

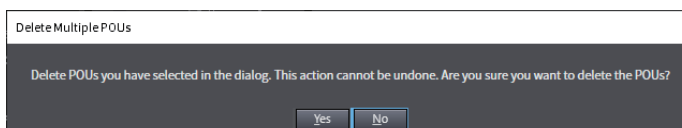

- 3** Click the **Yes** Button.
The selected POU's are deleted.

4-3 Creating Data Types

- Creating Data Types

Creating a data type involves defining a new data type by combining existing data types.

Data types registered using the Data Type Editor can be selected from the list of data types in the Variable Editor and used like any other data type. You can define data types that are structures, unions, or enumerations.

For information on data types, refer to the *NJ/NX-series CPU Unit Software User's Manual (Cat. No. W501)* or *NY-series Industrial Panel PC / Industrial Box PC Software User's Manual (Cat. No. W558)*.

- Opening the Data Types Tab Page

- 1 Double-click **Data Types** under **Programming - Data** in the Multiview Explorer. Or, right-click **Data Types** under **Programming - Data** and select **Edit** from the menu.

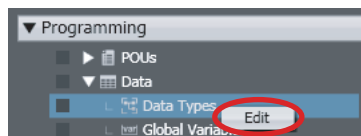

The Data Type Editor is displayed.



- Creating Structure Data Types

After you register the data type, add members.

- 1 Click the **Structures** Side Tab in the Data Type Editor.

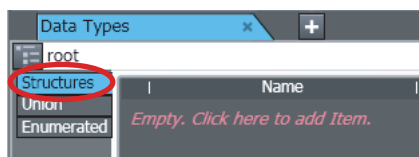

The Structure Data Type Editor is displayed.



- 2** If, as in this example, no data types are registered, click the Data Type Editor. A data type registration line is displayed.

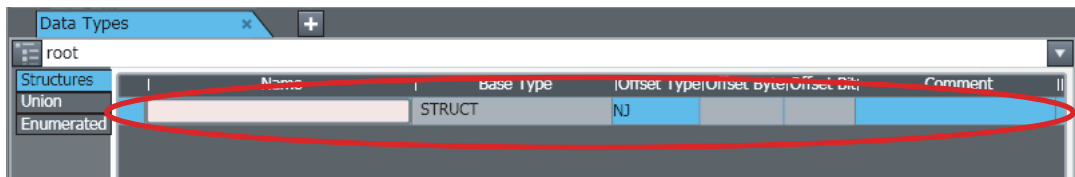

If you have already registered at least one data type, but you want to add more, press the Insert Key with the cursor inside the Data Type Editor. Or, right-click inside the Data Type Editor and select **Create New Data Type** from the menu.

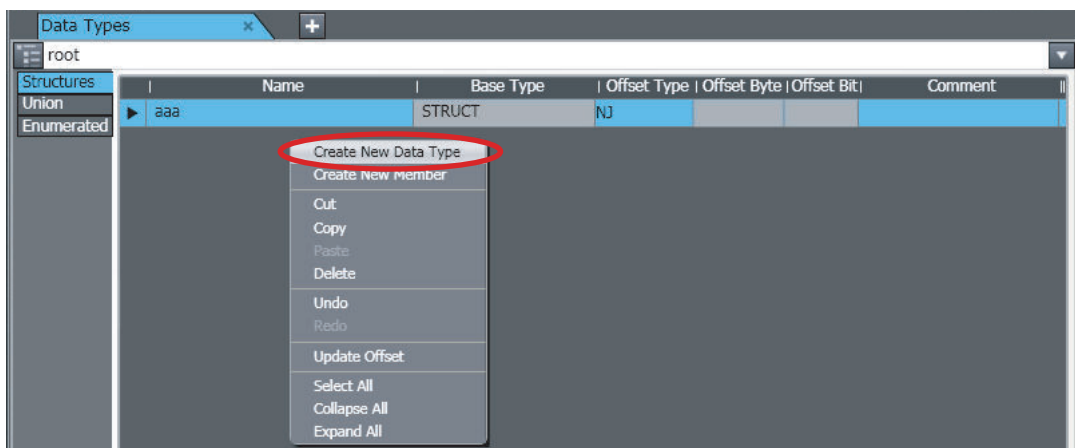

- 3** Enter values for each item, and then press the Enter Key.

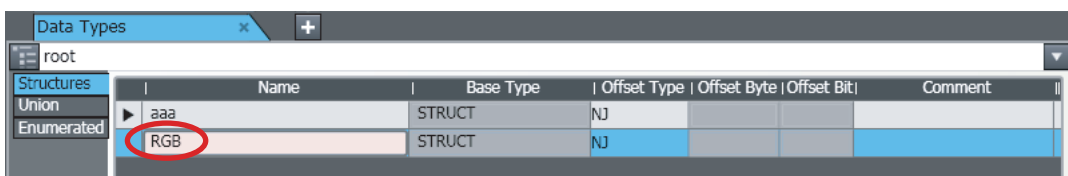

The data type is registered.

Refer to *Entering Data Type Attributes* on page 4-77 for information on entering values for attributes.

- 4** Next, add a member. Right-click the data type you just registered and select **Create New Member** from the menu.

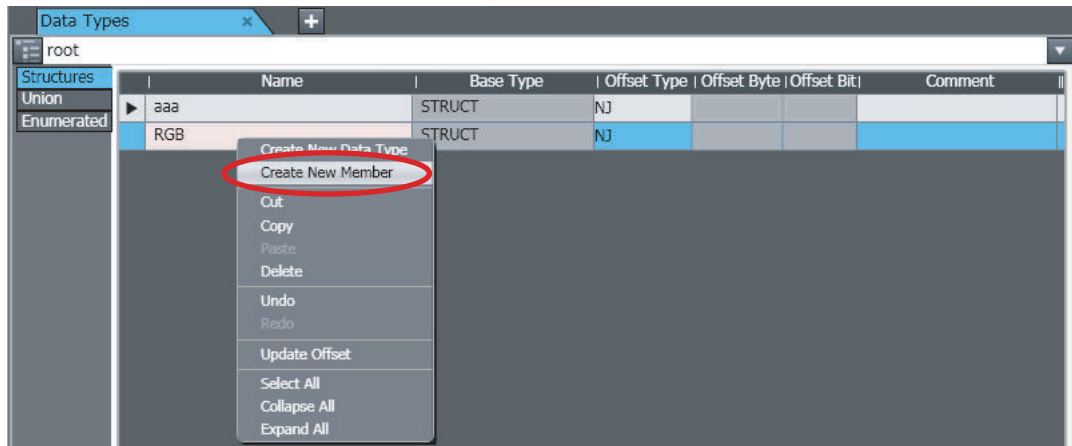

The member is created.

- 5 Enter values for each item, and then press the Enter Key.
The new member is added to the structure data type.

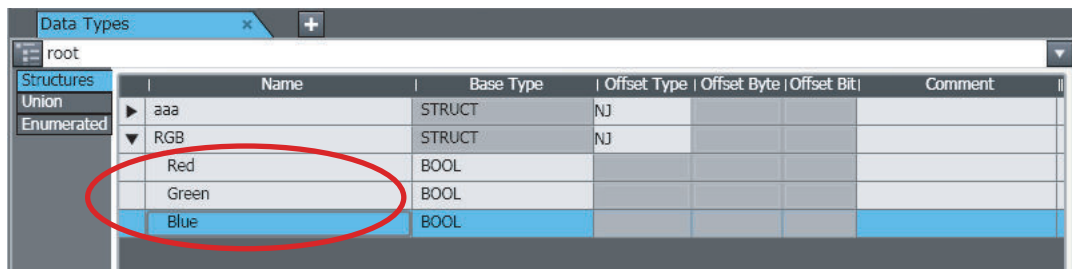

Refer to *Entering Data Type Attributes* on page 4-77 for information on entering values for attributes.

- 6 Repeat steps 4 and 5 to add additional members as required.

● Creating Unions

After you register the data type, add members.

- 1 Click the **Union** Side Tab in the Data Type Editor.

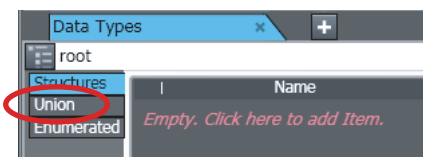

The Union Data Type Editor is displayed.



- 2** If, as in this example, no data types are registered, click the Data Type Editor. A data type registration line is displayed.

If you have already registered at least one data type, but you want to add more, press the Insert Key with the cursor inside the Data Type Editor. Or, right-click inside the Data Type Editor and select **Create New Data Type** from the menu.

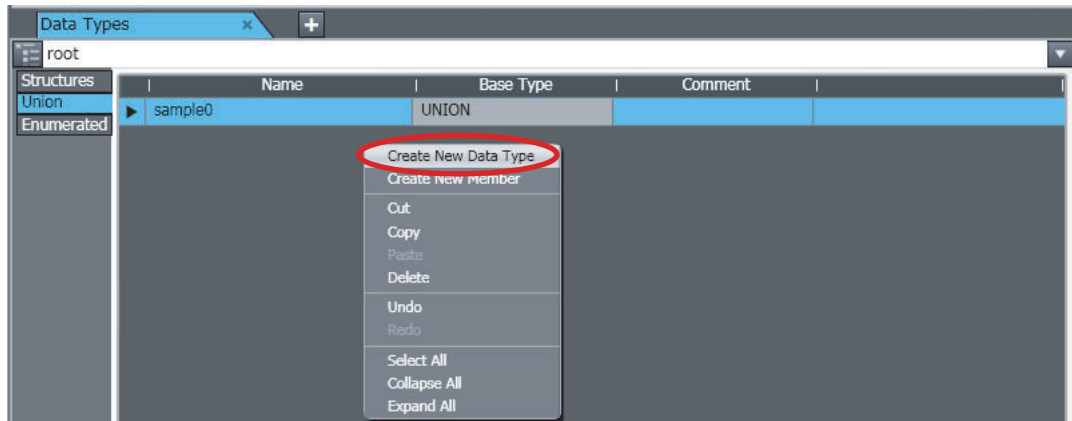

- 3** Enter values for each item, and then press the Enter Key.

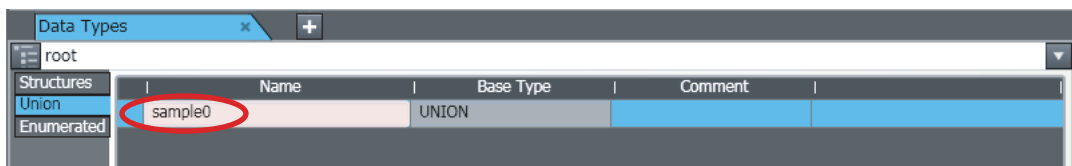

The data type is registered.

Refer to *Entering Data Type Attributes* on page 4-77 for information on entering values for attributes.

- 4** Next, add a member. Right-click the data type you just registered and select **Create New Member** from the menu.

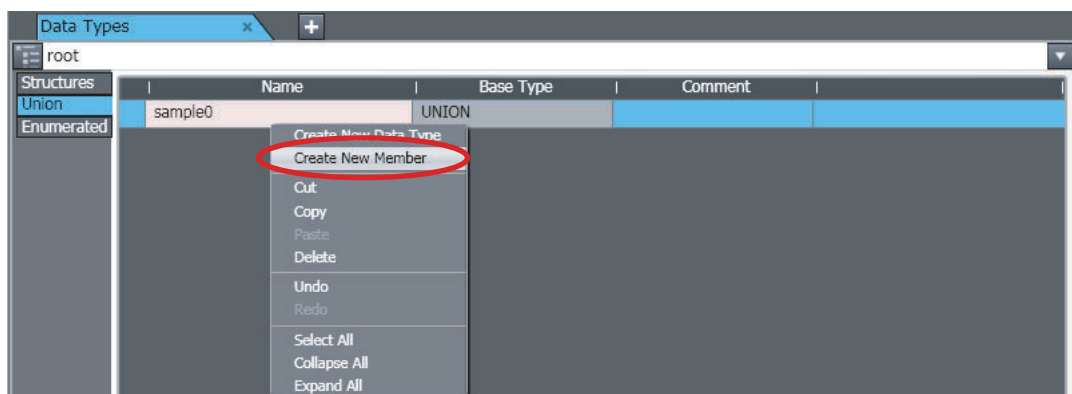

- 5** Enter values for each item, and then press the Enter Key.

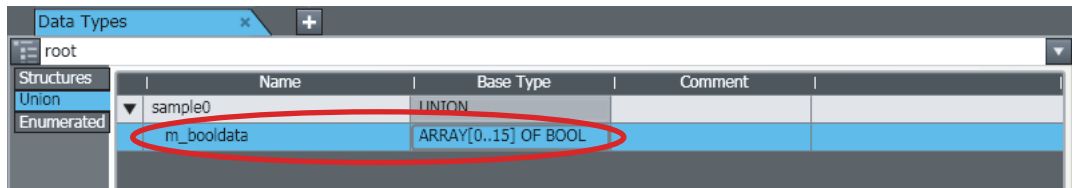

The new member is added to the union data type.

Refer to *Entering Data Type Attributes* on page 4-77 for information on entering values for attributes.

- 6 Repeat steps 4 and 5 to add additional members as required.

● Creating Enumerations

After you register the data type, add members.

- 1 Click the **Enumerated** Side Tab in the Data Type Editor. The Enumeration Data Type Editor is displayed.

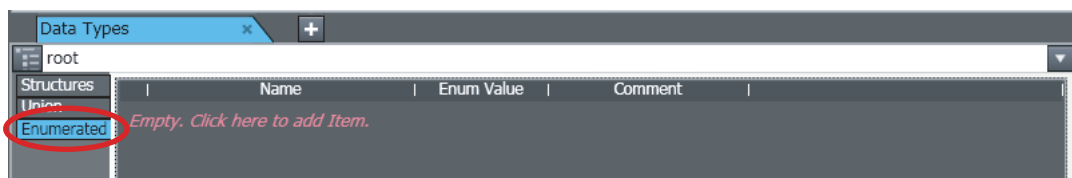

- 2 If, as in this example, no data types are registered, click the Data Type Editor. A data type registration line is displayed.

If you have already registered at least one data type, but you want to add more, press the Insert Key with the cursor inside the Data Type Editor. Or, right-click inside the Data Type Editor and select **Create New Data Type** from the menu.

- 3 Enter values for each item, and then press the Enter Key.

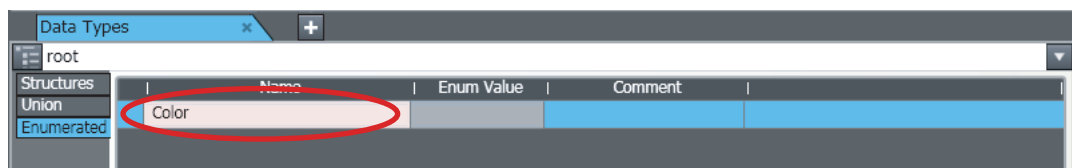

The data type is registered.

Refer to *Entering Data Type Attributes* on page 4-77 for information on entering values for attributes.

- 4 Next, add a member (i.e., an enumerator). Right-click the data type you just registered and select **Create New Member** from the menu.

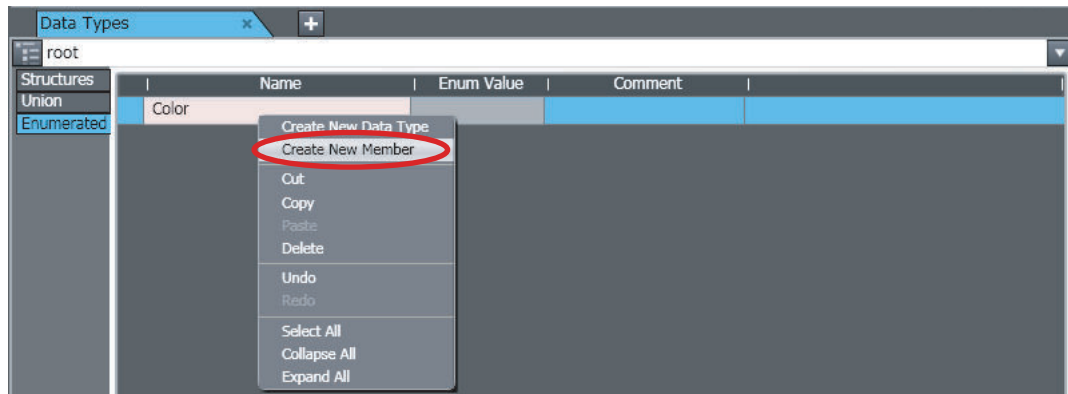

The new member (enumerator) is added to the enumeration data type.

- 5 Enter values for each item, and then press the Enter Key.

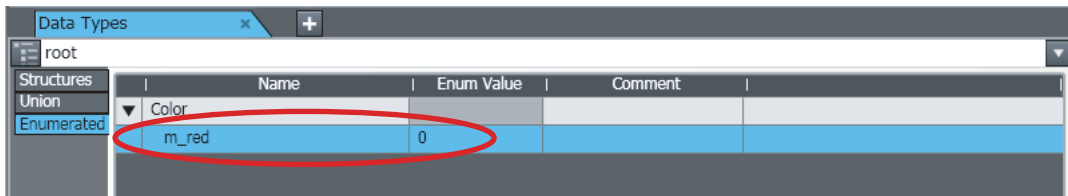

Refer to *Entering Data Type Attributes* on page 4-77 for information on entering values for attributes.

- 6 Repeat steps 4 and 5 to add additional members as required.

● Changing Data Types and Members

- 1 Click the cell to edit in the data type or member.

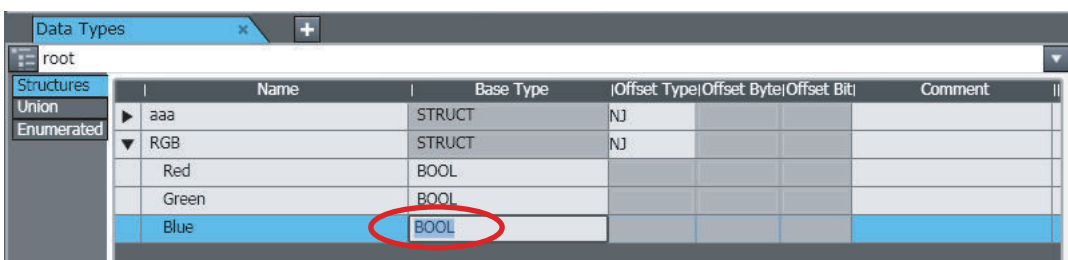

- 2 Change the setting, and then press the Enter Key.

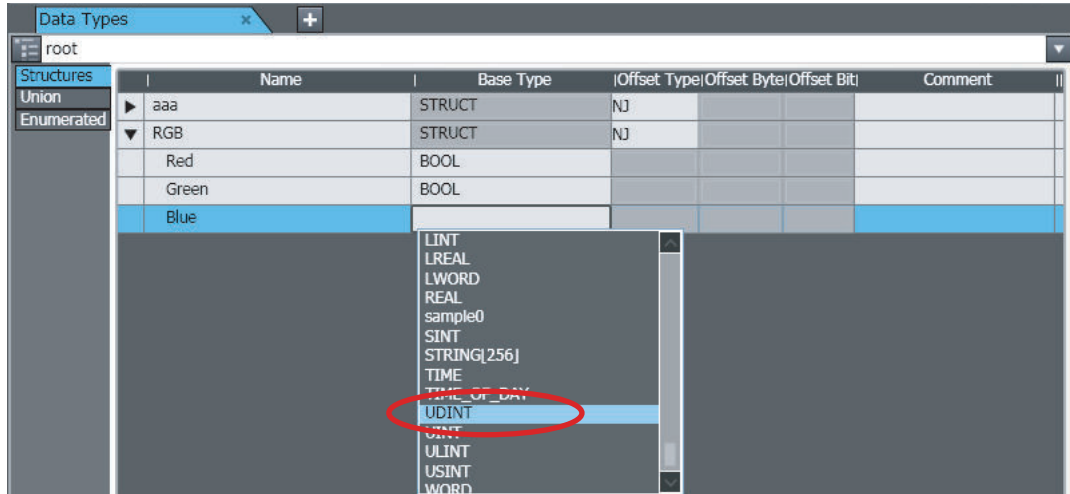

The change is applied to the data type or member.

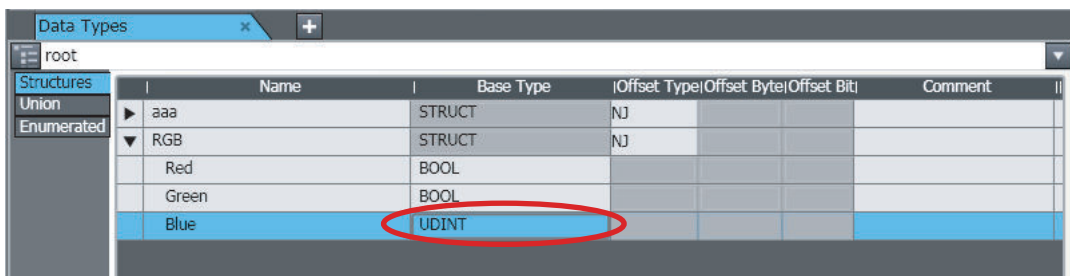

● Deleting Data Types and Members

- 1 Click any cell on the line of the data type or member to delete to select the entire line.
- 2 Press the Delete Key. Or, right-click a row and select **Delete** from the menu.

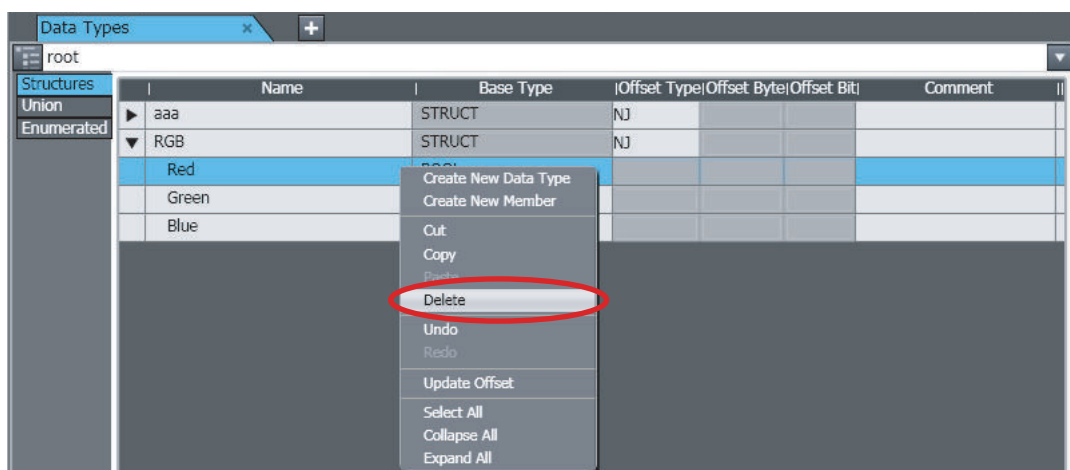

The data type or member is deleted.

● Copying and Pasting Data Types and Members

- 1 Click any cell on the line of the data type or member to copy.

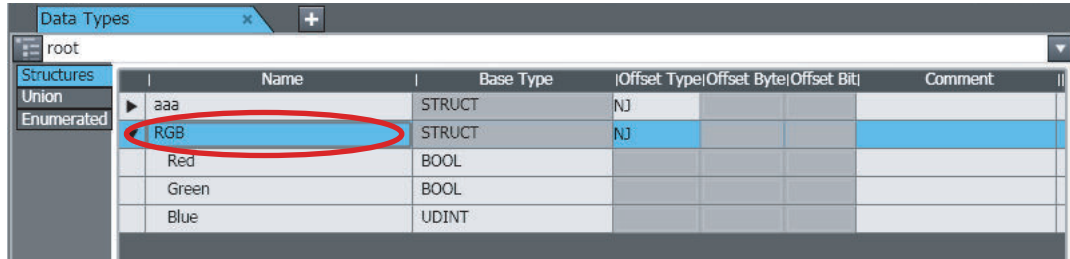

- 2 Press the Ctrl + C Keys. Or, right-click the row and select **Copy** from the menu.

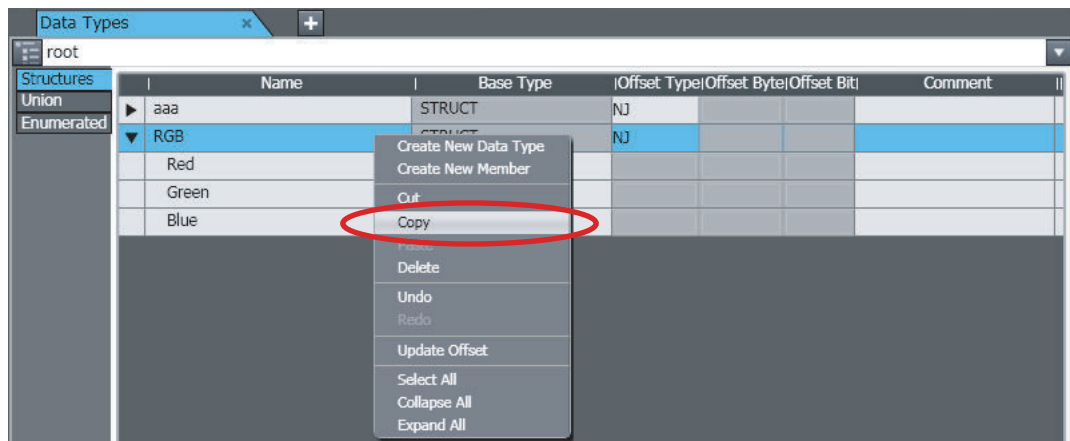

- 3 Press the Ctrl + V Keys. Or, right-click and select **Paste** from the menu.

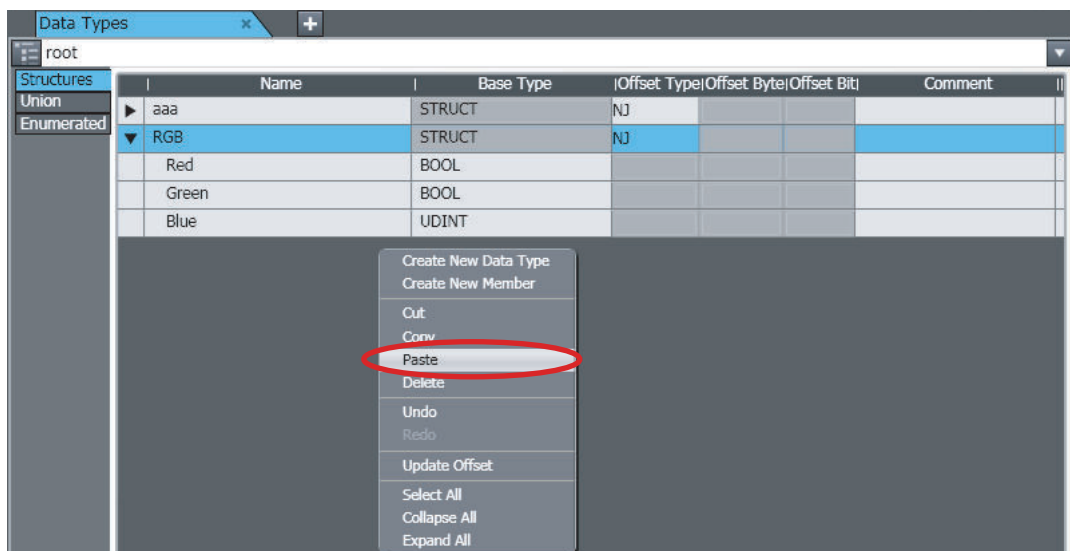

The data type or member is copied with `_Copy` added to the name of the data type or member that was copied.

Name	Base Type	Offset Type	Offset Byte	Offset Bit	Comment
aaa	STRUCT	NJ			
RGB	STRUCT	NJ			
Red	BOOL				
Green	BOOL				
Blue	UDINT				
RGB_Copy	STRUCT	NJ			
Red	BOOL				
Green	BOOL				
Blue	UDINT				



Precautions for Correct Use

If you use another structure as a member of a structure, you cannot specify a structure that results in recursion or a loop. An error is detected during the program check.



Additional Information

If the same data type names or member names already exist when you copy and paste data types or members from spreadsheets or other sources, a dialog box that shows a list of the source and destination data types and members is displayed. Select the data types and members to overwrite and execute the paste.

● Entering Data Type Attributes

This section describes how to enter data type attributes.

For information on attributes, valid value ranges, and character restrictions, refer to the *NJ/NX-series CPU Unit Software User's Manual (Cat. No. W501)* or *NY-series Industrial Panel PC / Industrial Box PC Software User's Manual (Cat. No. W558)*.

Data type attribute		Description
Name		Enter a text string for the name.
Base Type		Enter a data type directly or select one from the list. However, structures must be STRUCT and unions must be UNION.
Offset Type		Select the type of offsets to use for structure members. Refer to <i>Specifying Offsets for Structure Members</i> on page 4-78, below, for details.
Offset Byte		Set the offset of the member from the start of the structure variable. The current setting is displayed. You can enter a byte offset when the offset type is set to <i>User</i> .

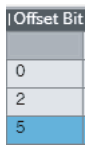
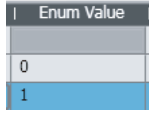
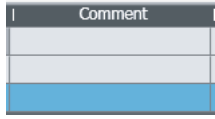
Data type attribute		Description
Offset Bit		Set the offset of the member from bit 0 at the specified byte position. The current setting is displayed. You can enter a bit offset when the offset type is set to <i>User</i> .
Enum Value		Enter the integer value that corresponds to the enumerator.
Comment		Enter a comment.

● Specifying Offsets for Structure Members

You can set offsets for members of a structure to define the memory configuration of the members. The offset specification aligns the memory configuration for structure members when you exchange data using tag specification between a CJ-series CPU Unit or other external device with different memory configurations.

For details, refer to the *NJ/NX-series CPU Unit Software User's Manual (Cat. No. W501)* or *NY-series Industrial Panel PC / Industrial Box PC Software User's Manual (Cat. No. W558)*.

Set the offset type according to your purpose.

Offset Type	Description
NJ	The optimum memory configuration for an NJ/NX/NY-series Controller is used for the fastest operation. Normally it is not necessary to make any changes.
CJ	The memory configuration of the CJ-series CPU Units is used. Suitable values are set for the byte and bit offsets.
User	This offset type allows you to set suitable values for the byte and bit offsets. You can set the byte and bit offsets that are necessary to match the memory structure of the external device.



Version Information

A CPU Unit with unit version 1.01 or later and Sysmac Studio version 1.02 or higher are required to set offsets for structure members.



Precautions for Correct Use

You cannot set initial values for variables that use structures for which member offsets are set. If you specify initial values, an error will occur.



Additional Information

- You can globally switch the comments that are displayed. Also, you can edit the display comments and switchable comments simultaneously from a variable table. Refer to *8-17 Changing Variable Comments and Data Type Comments* on page 8-140 for the actual procedures.

4-4 Namespaces

● Namespaces

Namespaces allow you to group and nest the names of data types, functions, and function block definitions so that you can manage them. This reduces the chance of duplicated names and makes the entities easier to access.

Use the following notation for names that use namespaces.

Device_A\Read_recipe
 ┌──────────┐ ┌──────────┐
 Name of namespace Short name
 └──────────┘
 Fully qualified name

Refer to the *NJ/NX-series CPU Unit Software User's Manual (Cat. No. W501)* or *NY-series Industrial Panel PC / Industrial Box PC Software User's Manual (Cat. No. W558)* for details on namespaces.

✓ Version Information

With Sysmac Studio version 1.14 or higher, you cannot create namespaces that start with *OmronLib*.

If you open a project that was created with Sysmac Studio version 1.13 or lower on Sysmac Studio version 1.14 or higher and the project contains a namespace that starts with *OmronLib*, an error will not occur, but you cannot create new namespaces that start with *OmronLib*.



Additional Information

- The root of a namespace is called the *global namespace*.
- Namespaces can be nested to up to three levels.

4-4-1 Data for Which You Can Use Namespaces

You can use namespaces for the following data.

- Data types
- Functions and function block definitions

4-4-2 Setting Namespaces

Data Types

Set the namespace and create the data type under it.

● Displaying Namespace Settings

- 1 Display the Data Type Editor and then click the *Namespace Tree* Button on the left edge of the table.
The namespace tree is displayed.

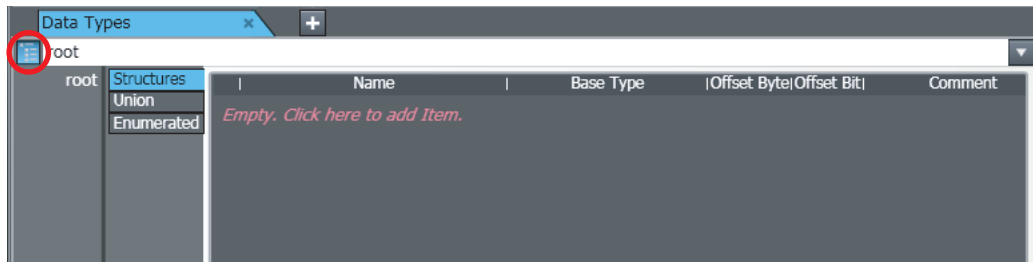

- 2 Select the namespace from the namespace tree.
All of the data types that belong to the selected namespace are displayed in the Data Type Editor.

● Adding Namespaces

- 1 Right-click a namespace and select **Create new child namespace** from the menu.

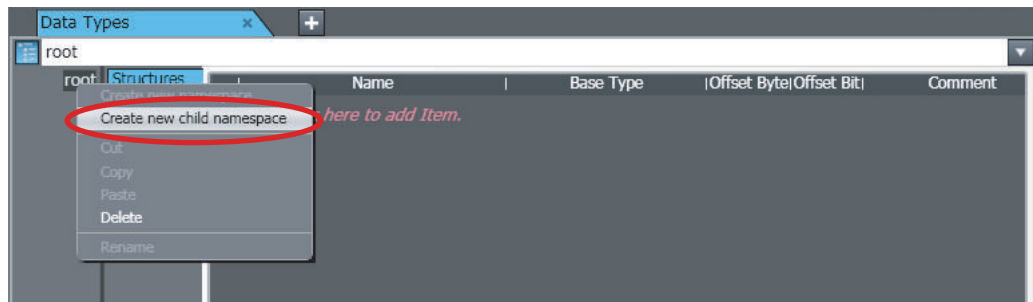

A namespace is added in the level below the selected namespace.

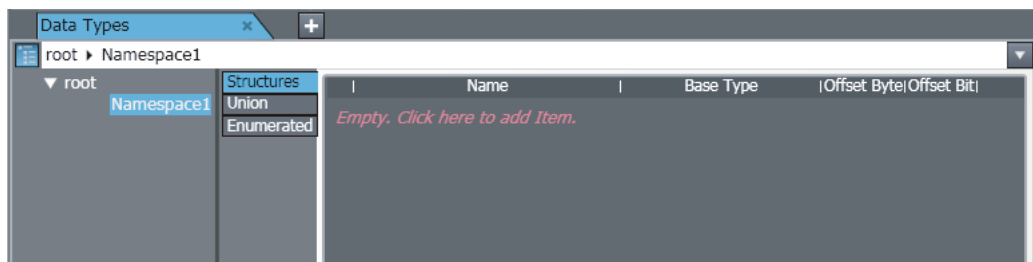

Additional Information

You can change the names of the namespaces. Right-click a namespace and select **Rename** from the menu or press the F2 Key.

● Deleting Namespaces

- 1 Right-click the namespace to delete and select **Delete** from the menu.
The namespace is deleted.



Precautions for Correct Use

When you delete a namespace, all of the namespaces at the levels below it and all data types that belong to it are also deleted.



Additional Information

You can delete all namespaces except for global namespaces at the same time. Right-click a global namespace and select **Delete** from the menu.

● Adding Data Types to Namespaces

- 1 Click the namespace to which to add a data type.
All of the data types that belong to the selected namespace are displayed in the Data Type Editor.
- 2 Register a data type using the normal data type registration procedure.
The data type is registered under the selected namespace.



Additional Information

You can delete, move, copy, and paste data types in the Data Type Editor for a namespace.

Functions and Function Block Definitions

Use the following procedure to set a namespace in the properties of a function or function block definition.

- 1 Right-click the function or function block definition and select **Properties** from the menu.
The properties of the function or function block definition are displayed.

The screenshot shows a 'Properties' dialog box with the following fields:

Name	Function0		
Namespace			
Version	0	0	0
Author	OMRON		
Created	2022/09/01 14:10:28		
Updated	2022/09/01 14:10:28		
Comment			

At the bottom of the dialog are 'OK' and 'Cancel' buttons.

- 2 Enter the namespace as text for the *Namespace* Field in the properties.

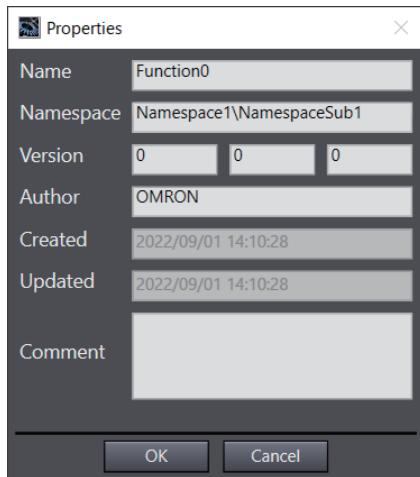

The fully qualified name of the function or function block definition is displayed in the Multiview Explorer.



Additional Information

- You can set the name of the namespace in the editor for the function or function block definition.

Click the *Namespace-Using Declaration Bar* in the editor, and then enter the name of the namespace in the *Namespace Field*.

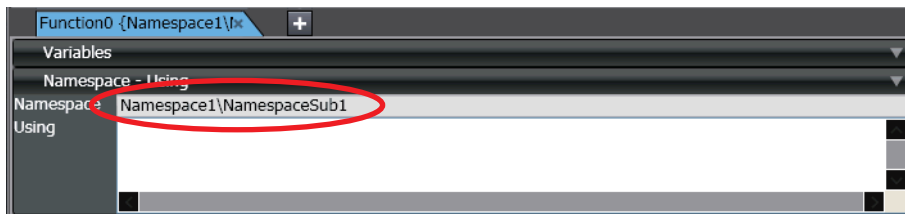

4-4-3 Using Namespaces

You can use the names of data types, functions, and function block definitions that use namespaces in the same way as you use names that do not use namespaces.

When you enter them, enter the fully qualified name. For functions that display candidates during text entry, the fully qualified names are displayed.

● Examples of Entering Fully Qualified Names

Item	Examples of fully qualified names
Data type	Namespace1\StructType1
Functions and function block definitions	<ul style="list-style-type: none"> Entry Example for Variable Table Namespace1\NamespaseSUB1\FB1 Entry Example for Ladder or ST Editor \\Namespace1\NamespaceSUB1\FN1

The following section describes a special method for that you can use for namespaces.

● Usage Declaration

When programming a ladder diagram or ST, you can declare a namespace for the POU in advance. This allows you to use the short names for function names and function block names.

- 1 Display the variable table in the Ladder Editor or ST Editor and click the *Namespace - Using* Bar.

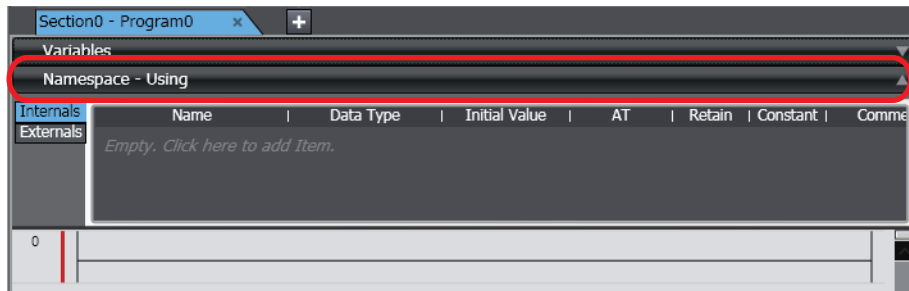

The Namespace and Using setting areas are displayed.

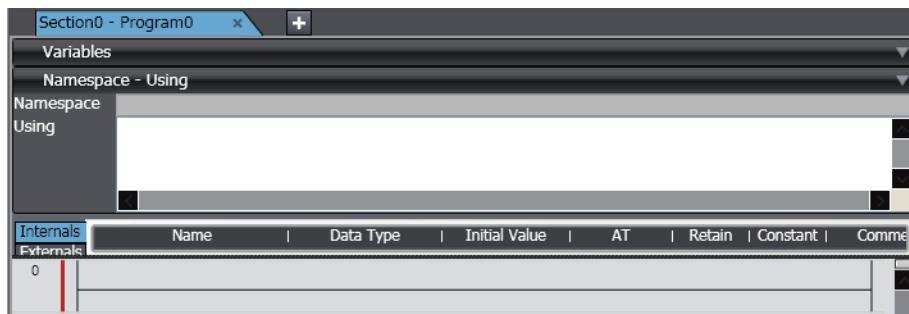

Note Refer to *Programming Ladder Diagrams* and *Programming Structured Text* for the procedures to display the Ladder Editor and ST Editor.

- 2 Enter the namespaces for the functions or function blocks to use in ladder programming or ST programming.
Example: The *Namespace1\NamespaceSub1\FN1* namespace for the function is declared in the ST Editor.

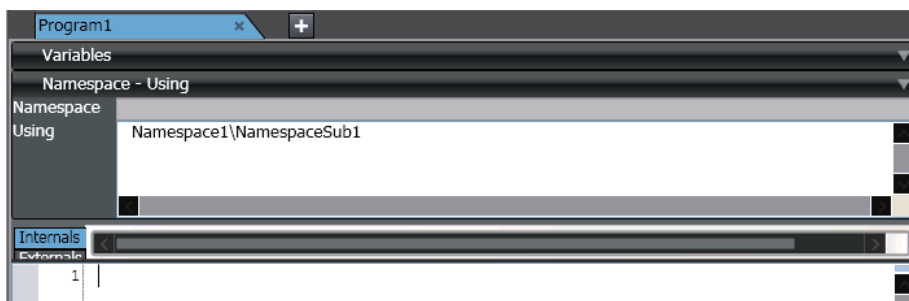

This allows you to enter the *short name* in the ladder diagram or ST.

Example:

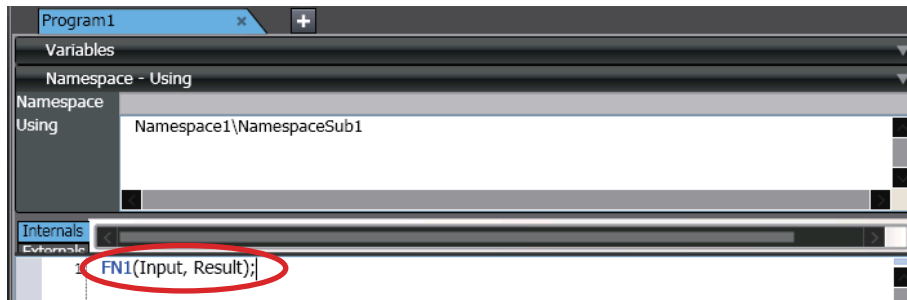

Precautions for Correct Use

- An error will occur during the program check if all of the names of namespaces are not unique when you enter the short names of function names and function block names after you declare the use of more than one namespace. If that occurs, enter the fully qualified names.
 - When you specify a data type in a variable table, you must enter the fully qualified name even if you have declared a namespace.
-



Additional Information

- You can enter the fully qualified names even if the use of a namespace is declared.
 - When you use functions or function block definitions that are in the same namespace, you can enter the short names even if you do not declare them.
 - Backslashes (\) in names that use namespaces in the ST Editor may be displayed as Yen symbols depending on the font that you use for the display. You can change the font in the option settings. Refer to *8-26 Sysmac Studio Option Settings* on page 8-166 for details.
-

4-5 Programming Ladder Diagrams

You can use either ladder diagrams (LD) or Structured Text (ST) to code the algorithms used in POU's (programs, functions, and function blocks).

This section describes how to program in ladder diagram notation.

- Programming Ladder Diagram

Programming a ladder diagram involves connecting circuit parts with connecting lines to build algorithms. You can enter circuit parts and connecting lines in the Ladder Editor.

4-5-1 Opening and Using the Ladder Editor

Programs

- 1 Double-click a section of a ladder diagram program under **Programming - POU's - Programs** in the Multiview Explorer. Or, right-click the section and select **Edit** from the menu.

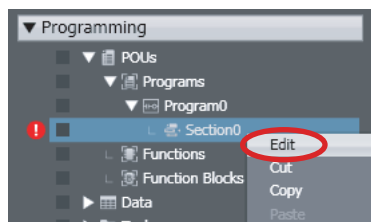

The Ladder Editor for the program is displayed.

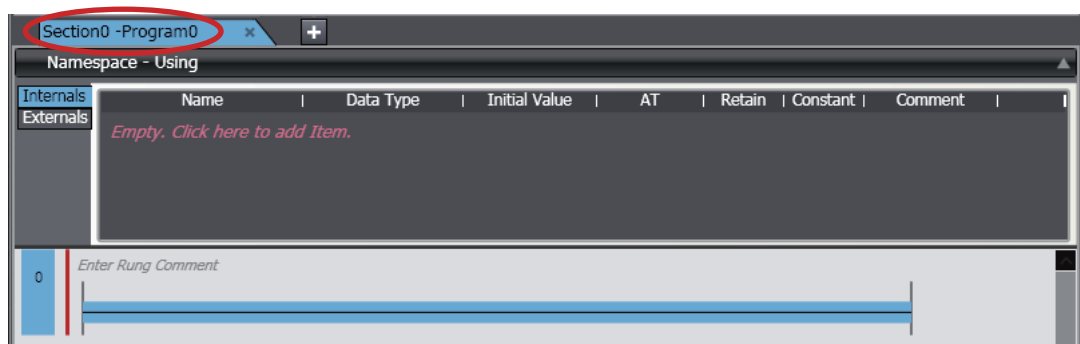

Refer to 4-2-2 *Registering Programs* on page 4-57 for the procedure to register a ladder diagram program.

Functions and Function Blocks

- 1 Double-click a ladder diagram function under **Programming - POU's - Functions** or a ladder diagram function block under **Programming - POU's - Function Blocks** in the Multiview Explorer. Or, right-click a ladder diagram function or function block and select **Edit** from the menu.

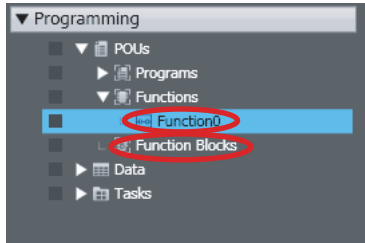

The Ladder Editor for the function or function block is displayed.

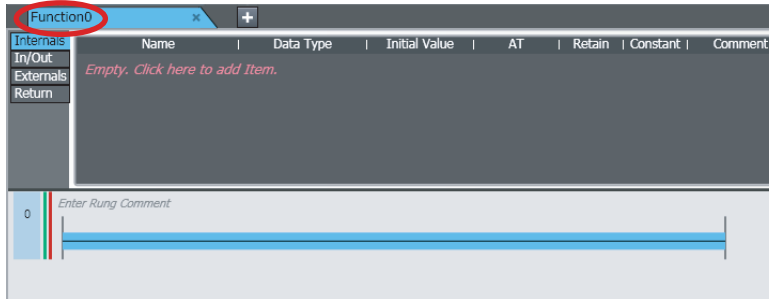

For information on registering ladder diagram functions or function blocks, refer to *4-2-3 Registering Function Blocks* on page 4-60 or *4-2-4 Registering Functions* on page 4-62.

4-5-2 Adding and Deleting Sections

- Sections

You can divide ladder diagrams into smaller units for easier management. These units of division are called *sections*.

Adding Sections

- 1 Select a ladder diagram program under **Programming - POUs - Programs** in the Multiview Explorer.

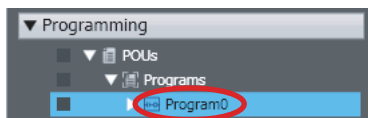

- 2 Right-click the ladder diagram program and select **Add - Section** from the menu.

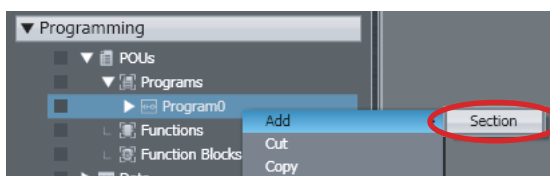

A section is added under the selected ladder diagram program.

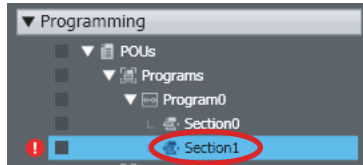

Changing the Order of Sections

Programs are executed from top to bottom in the order that the sections are displayed in the Multiview Explorer. To change the order of execution, you must change the order of the sections.

- 1 Select the section to change the order of under **Programming - POUs - Programs** in the Multiview Explorer.

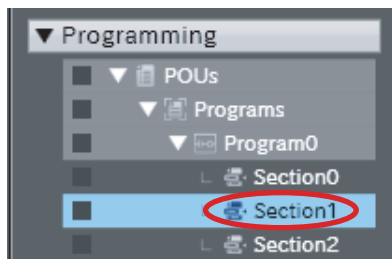

- 2 Right-click the section and select **Move Up** from the menu to move the section up, or select **Move Down** from the menu to move the section down. You can also drag the sections to change the order.

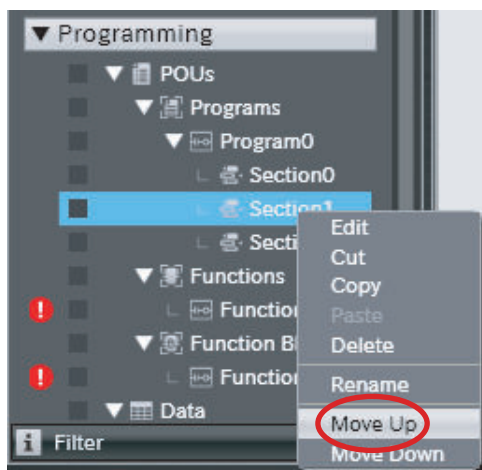

The selected section is moved up or down.

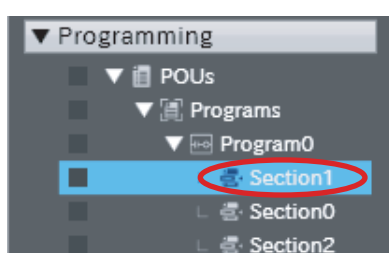

Right-click an existing section and select **Insert Above - Section**. A new section is inserted above the selected section.

Deleting Sections

- 1 Select the section to delete from a ladder diagram program under **Programming - POUs - Programs** in the Multiview Explorer.

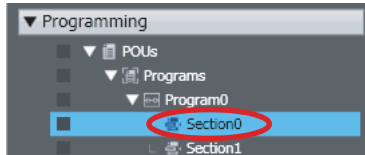

- 2 Right-click the section and select **Delete** from the menu. Or, select **Delete** from the **Edit** menu. You can also press the Delete Key to delete the section.

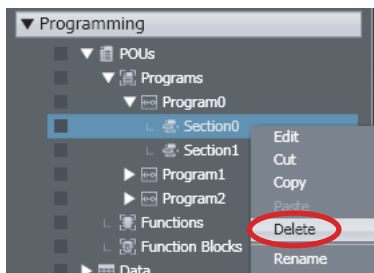

The selected section is deleted.

Copying and Pasting Sections

There are the following ways to copy sections.

- **Copy:** Only circuit data in the section is copied.
- **Copy with Dependents:** Not only the circuit data of the section but also variables that are referenced by the section and the data types of the variables are copied.

- 1 Select the section to copy from a ladder diagram program under **Programming - POUs - Programs** in the Multiview Explorer.

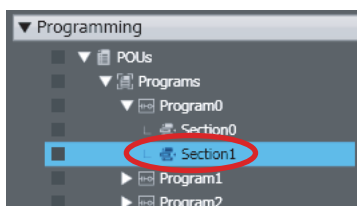

- 2 Press the Ctrl + C Keys. Or, right-click the section and select **Copy** from the menu. If you want to copy data together with referenced variables and their data types, select **Copy with Dependents**.

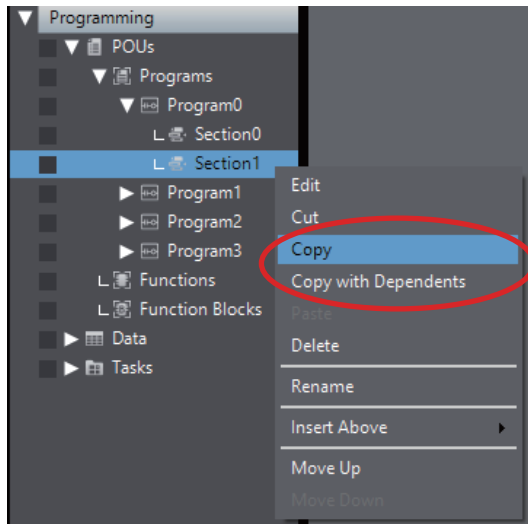

- 3 Press the Ctrl + V Keys. Or, right-click and select **Paste** from the menu.

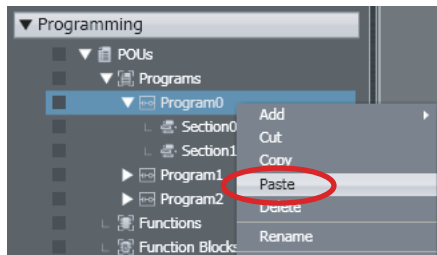

- When **Copy** is selected

The copied section is added. If a section with the same name already exists, a message box appears to confirm whether you want to overwrite the section. Click the **Yes** Button to overwrite the section. If you click the **No** Button, the section is added with the name *Copy_1_of_Section Name*.

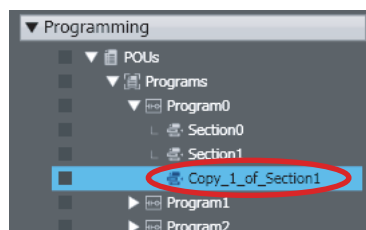

- When **Copy with Dependents** is selected

Not only the data that are copied with **Copy** but also global variables and their data types used in the section are pasted to the destination program.

If a variable or data type with the same name and different attribute already exists in the destination program, the **Comparison before pasting dependents** Dialog Box is displayed.

For details on the **Comparison before pasting dependents** Dialog Box, refer to *4-7 Comparison before Pasting Dependents* on page 4-166.



Precautions for Correct Use

- You cannot undo or redo actions performed on sections in the Multiview Explorer. After you delete a section, you cannot restore it.
- Changes that you make to a program affect all sections under that program as well.
- After you paste a section, check to be sure that the variables and data types are used correctly.



Additional Information

To switch the display between different sections, click the tab for the desired section name.

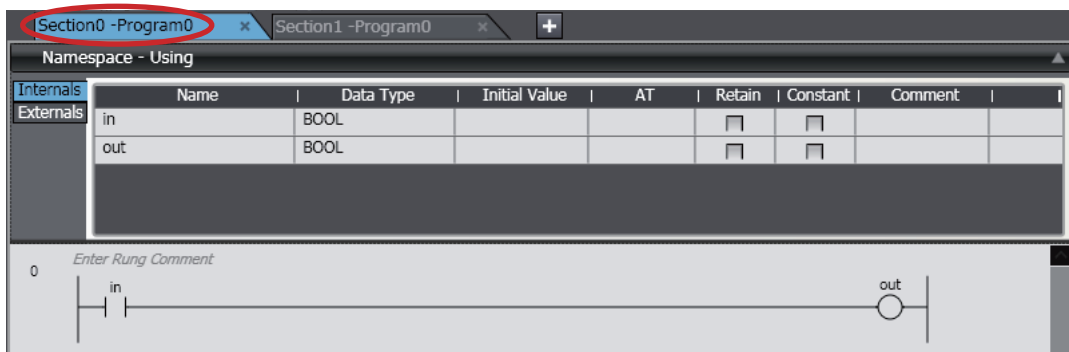

4-5-3 Basic Ladder Editor Operations



Basic Circuit Part Operations

- Inserting Circuit Parts

You insert circuit parts in the Ladder Editor to create an algorithm.

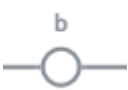
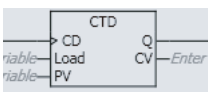
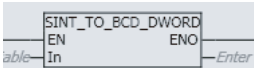
The following circuit parts are supported.

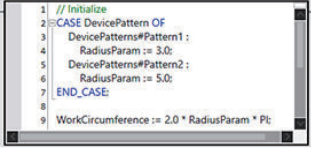
Circuit Part	Description
Input 	A program input.
Output 	A program output.
Function block 	An instruction that defines an operation.
Function 	An instruction to perform a single function.

Circuit Part		Description
Inline ST	 <pre> 1 // Initialize 2 CASE DevicePattern OF 3 DevicePatterns#Pattern1 : 4 RadiusParam := 3.0; 5 DevicePatterns#Pattern2 : 6 RadiusParam := 5.0; 7 END_CASE; 8 9 WorkCircumference := 2.0 * RadiusParam * Pi; </pre>	An ST program that is entered in a ladder program.
Jump		A jump starting point to another rung.
Jump label		A label that designates a jump destination.

● Methods for Inserting Circuit Parts

There are four basic ways to insert circuit parts.

Method (1) Drag a circuit part from the Toolbox.

Method (2) Right-click a connecting line and select **Insert Circuit Part** from the menu.

Method (3) Select a connecting line and press the shortcut key to insert a circuit part.

Method (4) Select a connecting line and then select a circuit parts from **Insert - Circuit Parts** on the Main Menu.

Inserting Program Inputs and Outputs

● Inserting a Program Input in an AND Structure

There are four methods to insert an input in an AND structure.

Method (1) Drag an input from the Toolbox.

Method (2) Right-click a connecting line and select **Insert Input** from the Menu.

Method (3) Select a connecting line and press the C Key.

Method (4) Select the location at which to insert the input and select **Insert - Circuit Parts - N.O. Input**.

The procedures to insert the input that is shown in the following figure are given below.

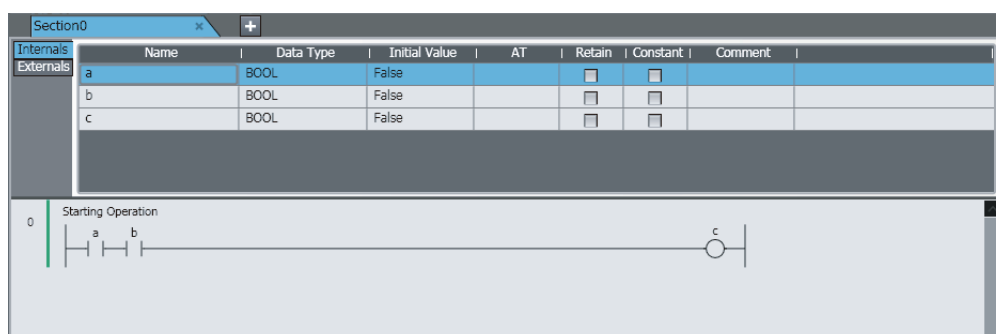

Method (1) Dragging an Input from the Toolbox

Select **Input** in the **Ladder Tools** in the Toolbox and drag it to the location where you want to insert it in the Ladder Editor.

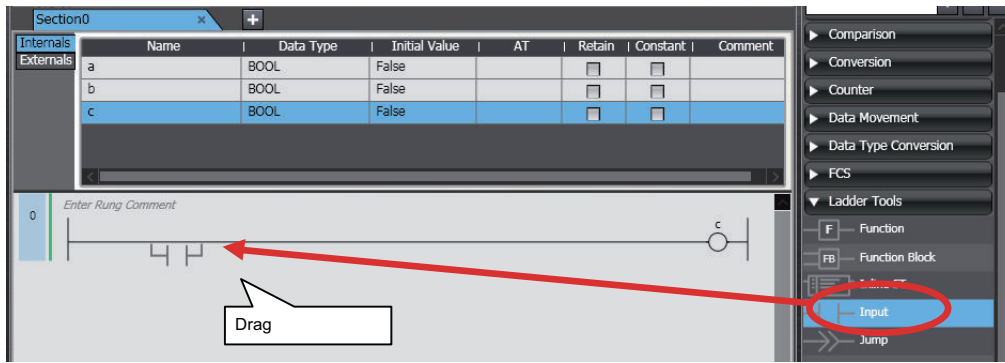

The input is inserted.



Method (2) Right-clicking a Connecting Line and Selecting Insert Input from the Menu

Right-click the connecting line where you want to insert the input and select **Insert Input** from the menu.

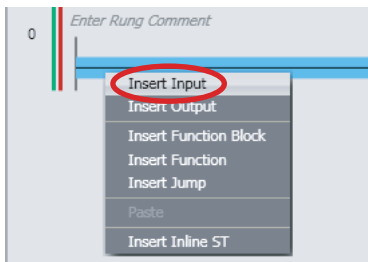

The input is inserted.



Method (3) Selecting a Connecting Line and Pressing the C Key

Select a connecting line and then press the C Key.

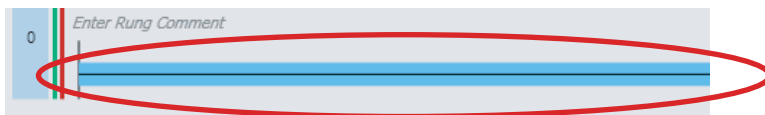

The input is inserted.



Method (4) Selecting the Location at Which to Insert the Input and Selecting Insert - Circuit Parts - N.O. Input.

Select the location at which to insert the input and then select **Insert - Circuit Parts - N.O. Input**.

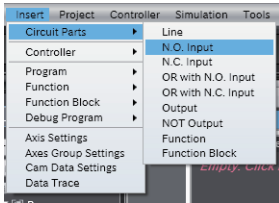

The input is inserted.



● Inserting a Program Input in an OR Structure

There are five ways to insert an input in an OR structure.

Method (1) Drag an input from the Toolbox to the input that is above where you want to insert the input.

Method (2) Right-click the input where you want to insert the OR input and select **Insert Parallel Input Above** or **Insert Parallel Input Below** from the menu.

Method (3) Drag the connecting line from the start point to insert the input to the connecting line at the end point.

Method (4) Select an input and press the W Key. For a NOT input, press the X Key.

Method (5) Select the location at which to insert the input and select **Insert - Circuit Parts - OR with N.O. Input**.

The procedures to insert the input that is shown in the following figure are given below.

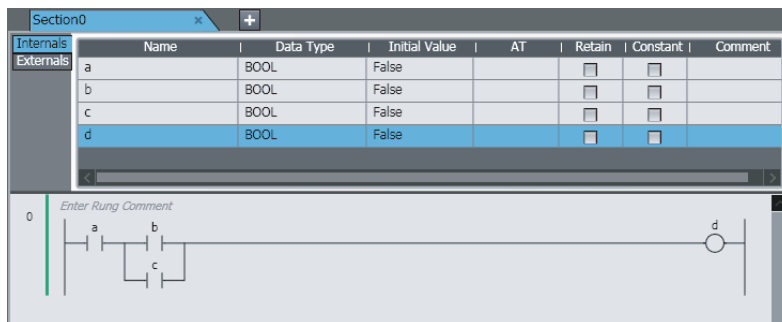

Method (1) Dragging an Input from the Toolbox to the Input that Is Above Where You Want to Insert the Input

Select **Input** in the **Ladder Tools** in the Toolbox and drag the input to the input that is above the location where you want to insert it in the Ladder Editor.

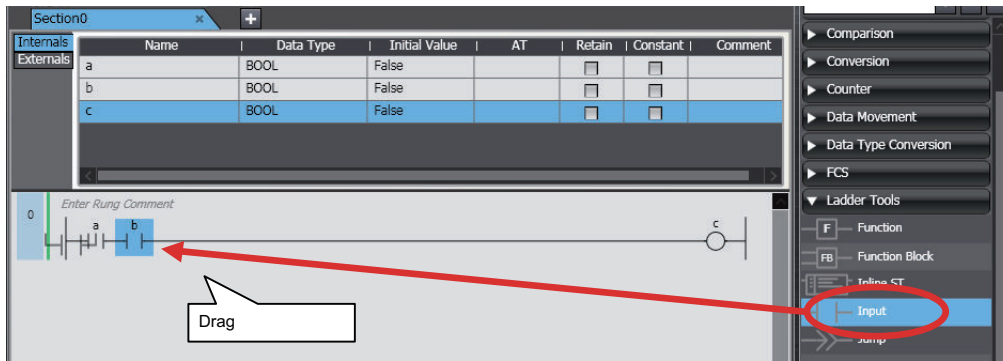

The input is inserted in an OR structure.

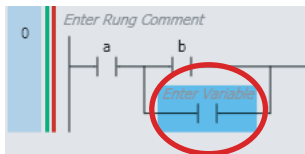

Method (2) Right-clicking the Input Where You Want to Insert the OR Input and Selecting Insert Parallel Input Above or Insert Parallel Input Below from the Menu

Right-click the input where you want to insert the OR input and select **Insert parallel input below** from the menu.

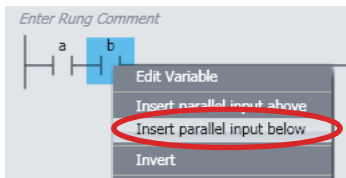

The input is inserted in an OR structure.

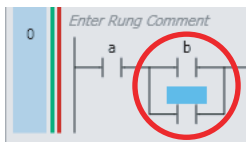

Method (3) Dragging the Connecting Line from the Start Point to Insert the Input to the Connecting Line at the End Point

Drag the connecting line from the start point where you want to insert the input to the end point.



The pop-up menu is displayed.

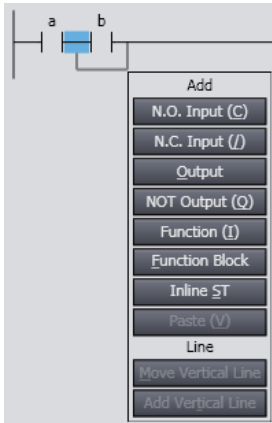

Select *N.O. Input*. Or, press the Enter Key.

The input is inserted in an OR structure.

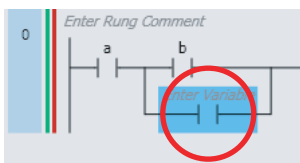

If you drag a connecting line to connect across the rung without a program input, a program input is inserted automatically.

Insertion Example:

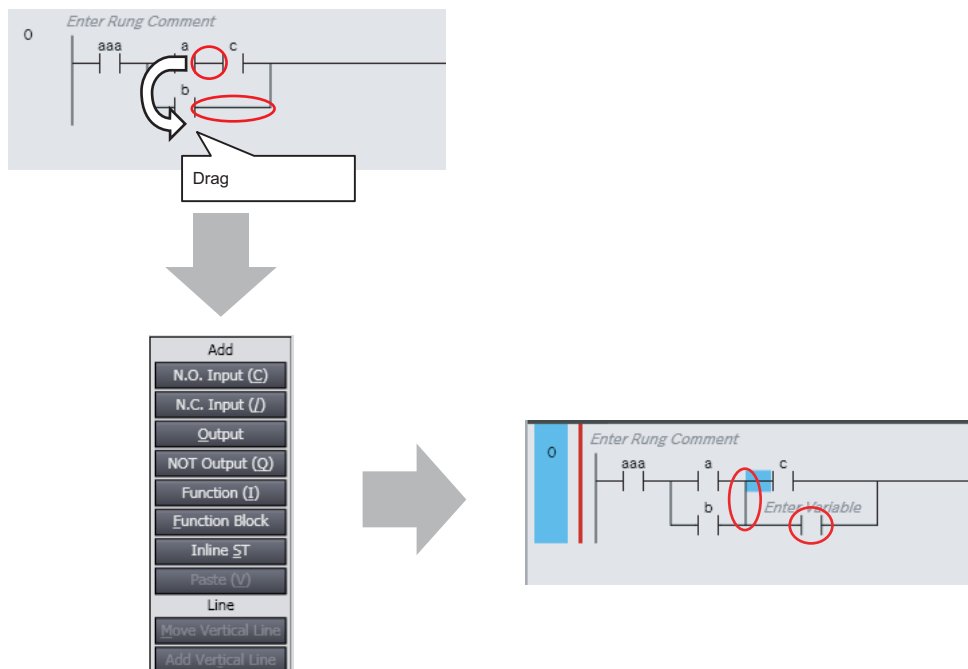

Select **Add Vertical Line** from the pop-up menu or press the **Enter** Key.

Method (4) Selecting an Input and Pressing the W Key For a NOT input, press the X Key.

Select the input above the location where you want to insert the input and press the W Key.

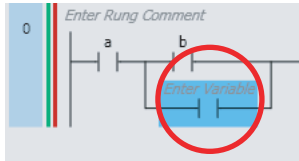

The input is inserted in an OR structure.

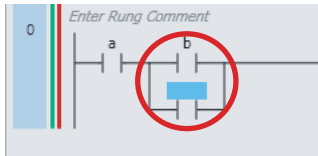

Method (5) Selecting the Location at Which to Insert the Input and Selecting Insert - Circuit Parts - OR with N.O. Input

Select the input above the location at which to insert the input and then select **Insert - Circuit Parts - OR with N.O. Input**

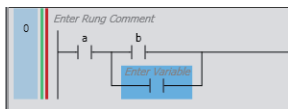

The input is inserted in an OR structure.

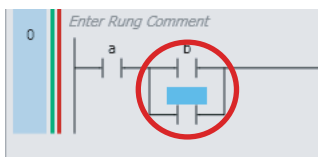

● Inserting a Program Output in an AND Structure

There are four ways to insert an output in series.

Method (1) Drag an output from the Toolbox.

Method (2) Right-click a connecting line and select **Insert Output** from the menu.

Method (3) Select a connecting line and then press the O Key. For a NOT output, press the Q Key.

Method (4) Select the location at which to insert the output and select **Insert - Circuit Parts - Output**.

The procedures to insert the output that is shown in the following figure are given below.

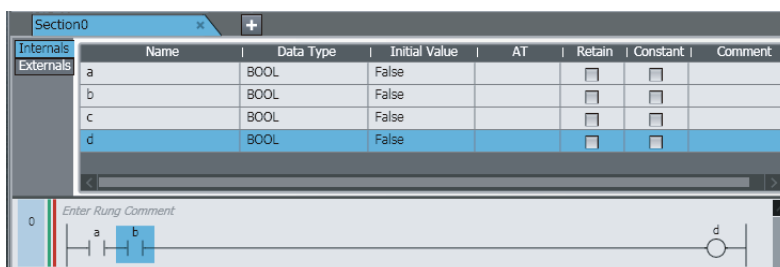

Method (1) Dragging an Output from the Toolbox

Select **Output** in the **Ladder Tools** in the Toolbox and drag it to the location where you want to insert it in the Ladder Editor.

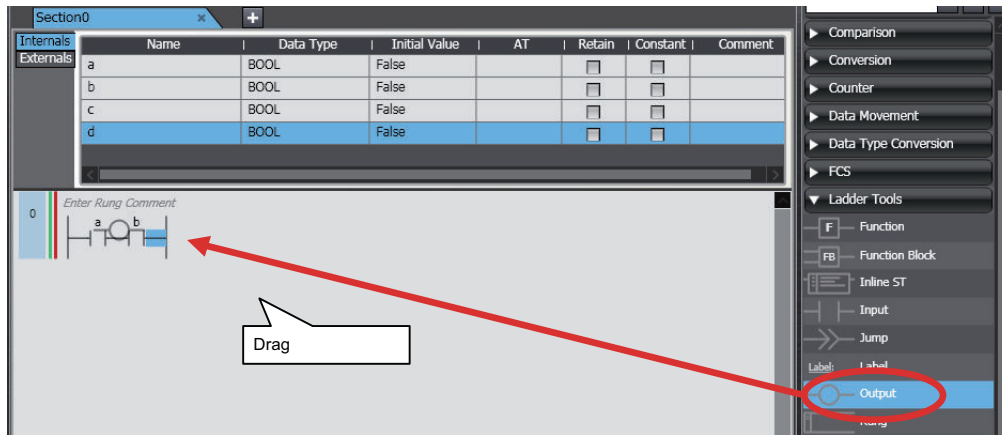

The output is inserted.



If you drop the output on a connecting line, the output is inserted in series.

Method (2) Right-clicking a Connecting Line and Selecting Insert Output from the Menu

Right-click the connecting line where you want to insert the output and select **Insert Output** from the menu.

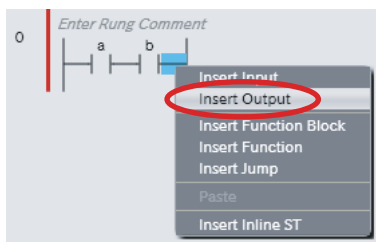

The output is inserted.



Method (3) Selecting a Connecting Line and Pressing the O Key For a NOT output, press the Q Key.

Select the output above the location where you want to insert the output and press the O Key.

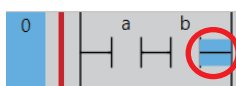

The output is inserted.



Method (4) Selecting the Location at Which to Insert the Output and Selecting Insert - Circuit Parts - Output.

Select the location at which to insert the output and then select **Insert - Circuit Parts - Output**.

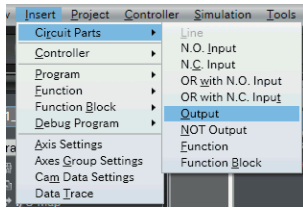

The output is inserted.

● Inserting a Program Output in an OR Structure

There are three ways to insert an output in an OR structure.

Method (1) Drag an output from the Toolbox to the location above the coil with which an OR structure is required.

Method (2) Drag the connecting line from the start point to insert the output to the end point at the right bus bar

Method (3) Right-click the output where you want to create the OR structure in the Ladder Editor and select **Insert Parallel Output** from the menu.

The procedures to insert the output that is shown in the following figure are given below.

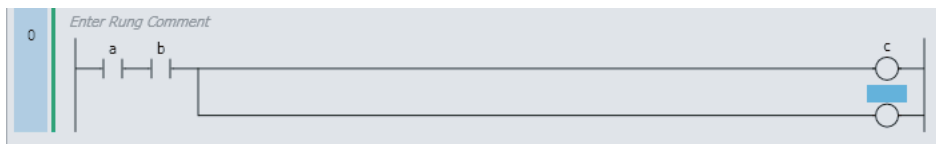

Method (1) Dragging an Output from the Toolbox

Select **Output** in the **Ladder Tools** in the Toolbox and drag it to the location where you want to insert it in the Ladder Editor.

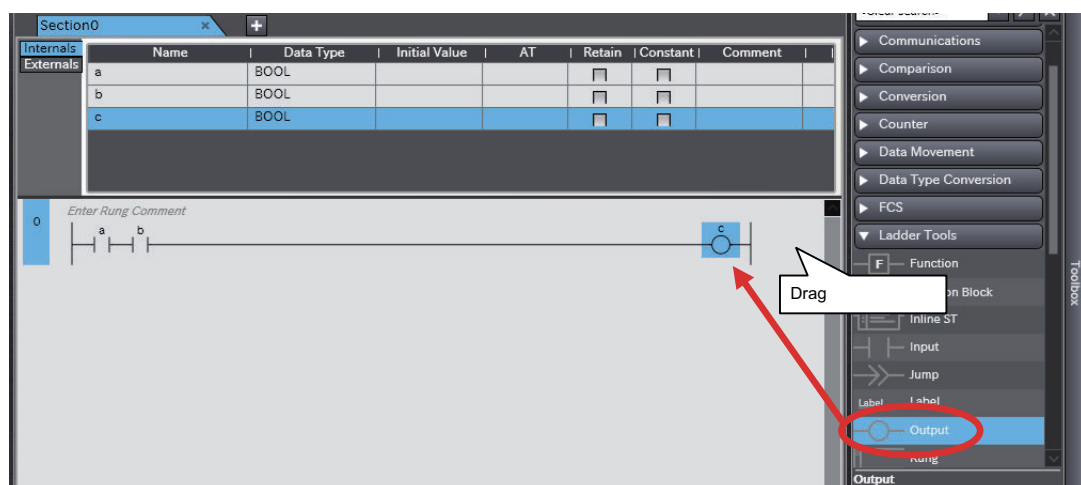

The output is inserted.



If you drop the output on a connecting line, the output is inserted in series.

Method (2) Dragging the Connecting Line from the Start Point to Insert the Output to the End Point at the Right Bus Bar

Drag the connecting line from the start point where you want to insert the output to the right bus bar at the end point.

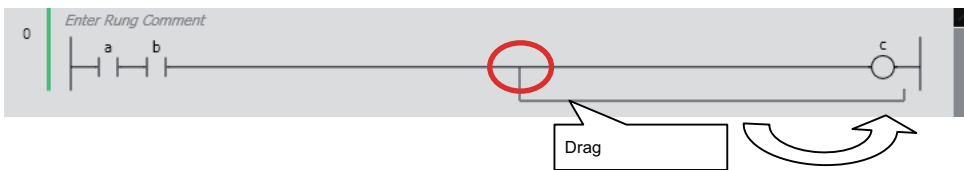

The pop-up menu is displayed.

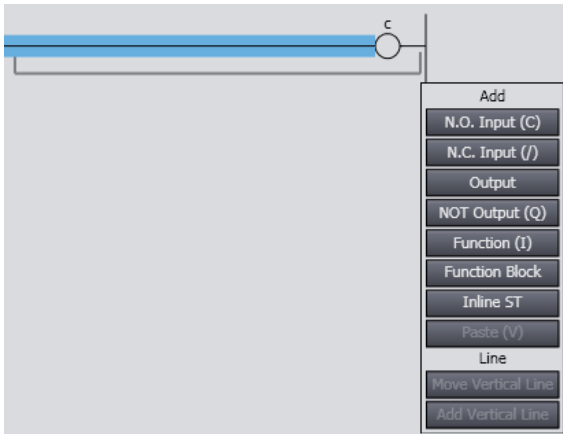

Select *Output*. Or, press the Enter Key.

The output is inserted.



Method (3) Right-clicking the Output Where You Want To Create the OR Structure in the Ladder Editor and Selecting Insert Parallel Output from the Menu

Right-click the output where you want to insert the OR output and select **Insert parallel output above** or **Insert parallel output below** from the menu.



The output is inserted in an OR structure.



Procedures for Changing Circuit Parts

● Editing Program Inputs and Outputs (Negating Inputs and Outputs)

- 1 Select an input or an output, and then press the / Key. Or, right-click the input or output and select **Invert** from the menu.

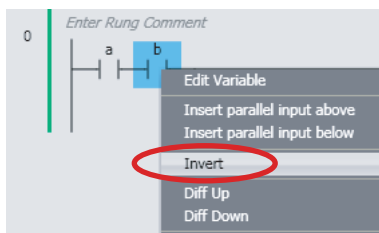

The N.O./N.C. state of the input or output is reversed.

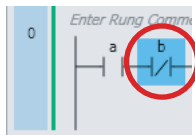

● Editing Program Inputs and Outputs (Setting Differentiation)

- 1 To set upward differentiation, right-click the input or output and select **Diff Up** from the menu. To set downward differentiation, select **Diff Down** from the menu.

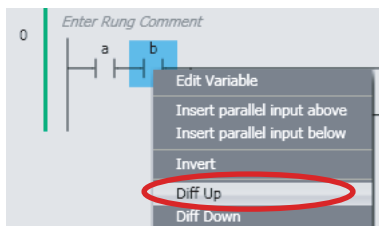

Upward differentiation or downward differentiation is set.

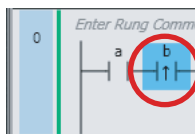

Procedures for Deleting Circuit Parts

● Deleting Program Inputs

- 1 Right-click the input you want to delete and select **Delete** from the menu. Or, select the input and press the Delete Key.

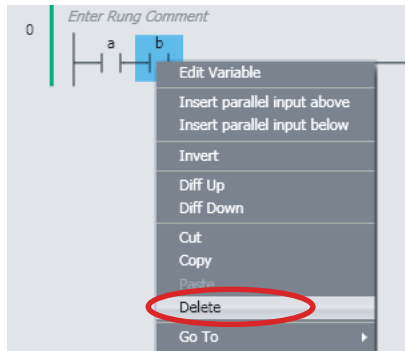

The selected input is deleted.

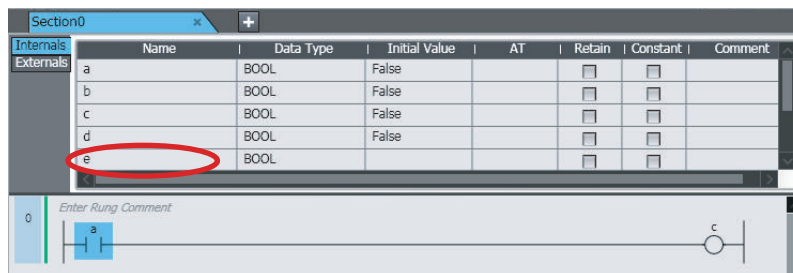

In this case, any variables assigned to the input are not deleted from the local variable table or global variable table.

● Deleting Outputs

- 1 Right-click the output you want to delete and select **Delete** from the menu. Or, select the output and press the Delete Key.

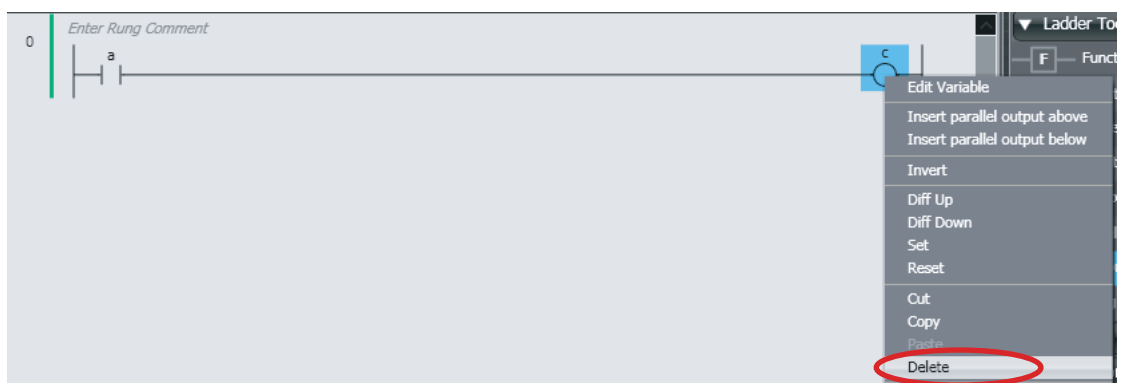

The selected output is deleted.

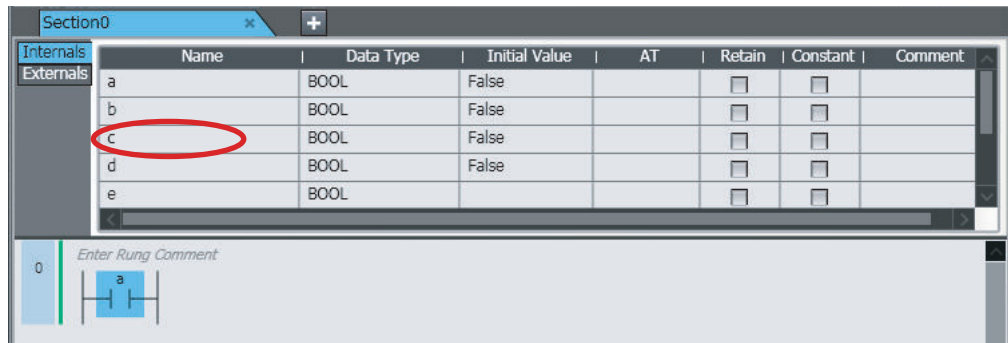

In this case, any variables assigned to the output are not deleted from the local variable table or global variable table.



Additional Information

You can specify the rung display width to align the positions of the right bus bars of rungs. Specify the rung display width in the option settings. Refer to *8-26 Sysmac Studio Option Settings* on page 8-166 for details.

Entering Variables in Circuit Parts

Use the following method to enter variables into a program input or output that you have inserted. All variables with the correct data type are displayed in the list.

Entering Global Variables

Method (1) Select a variable that is already registered in the global variable table from the list in the Ladder Editor.

Local Variables

Method (1) Select a variable that is registered in the local variable table from the list in the Ladder Editor.

Method (2) Drag a variable from the local variable table of the POUs to the Ladder Editor.

Method (3) Enter a variable in the Ladder Editor (or the ST Editor) before you register the variable in the local variable table.

The procedures to enter the variables that are shown in the following figure are given below.

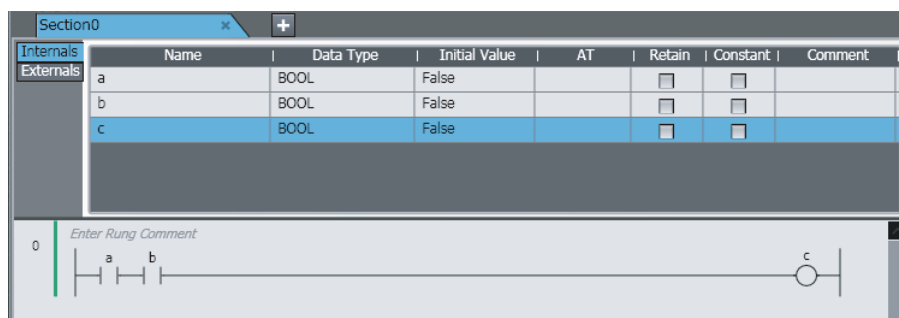

Method (1) Selecting a Variable in the Ladder Editor

Select the input, click **Enter Variable** or press the Ctrl + Space Keys, and then select a variable from the list. The variables of the same type as the input are displayed as candidates in the list.

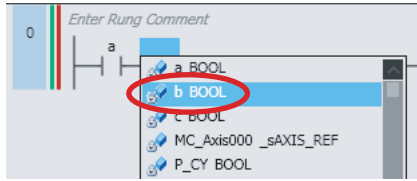

The variable is entered.

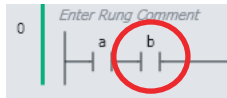

Method (2) Dragging a Variable from the Local Variable Table of the POU

Drag the variable you want from the local variable table to the input.

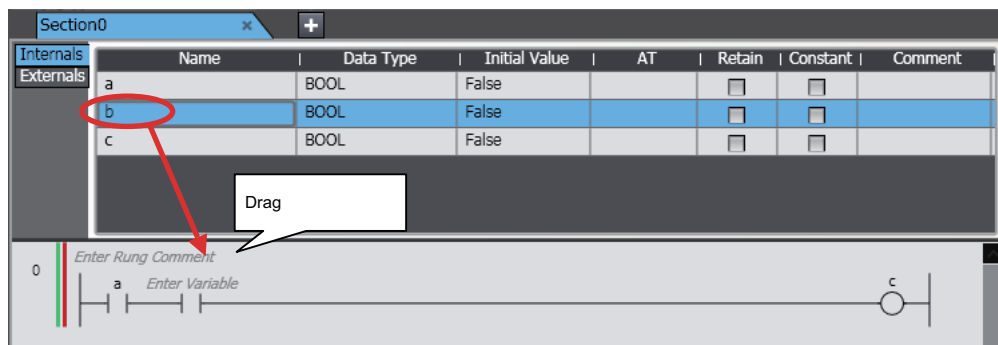

The variable is entered.

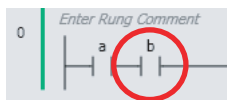

Method (3) Enter a variable in the Ladder Editor (or the ST Editor) before you register the variable in the local variable table.

Select a program input, click **Enter Variable**, and enter the variable directly.

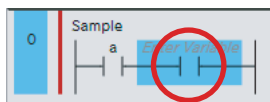

The variable is entered.

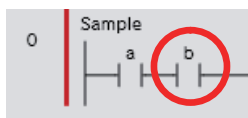



Additional Information

- Members of derivative variables also appear in the list as long as they have the correct data type.
- You cannot view addresses in memory for CJ-series Units or I/O ports in the Ladder Editor, only the variable names. You also cannot see if a variable has an AT specification.
- The variable names of any new variables that you enter in the Ladder Editor are automatically registered in the local variable table. You can select the **Select local or global variable and register it** Check Box in the option settings to specify the variable table in which the variable names are registered. Refer to *8-26 Sysmac Studio Option Settings* on page 8-166 for details.
- You can identify the following types of variables in the Ladder Editor by their color.
 - a) Global variables
 - b) Local variables
 - c) AT specification variables
 - d) Network variables
 You can change the color of the global variables, the background color of the AT specification variables, and the background color of the network variables in the options settings.
- If you select the *Show comment* Check Box for variable comments in the option settings, you can enter a variable comment when you enter a variable.



- You can change the display width for variable names in the option settings.
- If an NA-series PT is registered in the project, you can drag program inputs and program outputs from the Ladder Editor to the NA-series PT Page Editor to add them as buttons and lamps. Refer to the *NA-series Programmable Terminal Software User's Manual (Cat. No. V118)* for details.
- If you move the mouse over a circuit part or select **Show Tooltip**, supplemental information on the variable that you entered is displayed in the tooltip. Refer to *Show Tooltip* on page 4-141 for detail.

● Inserting Rungs

You can use the following procedures to insert rungs.

Method (1) Select Rung under Ladder Tools in the Toolbox and then drag the rung to the beginning of the rung in front of the location where you want to insert the rung.

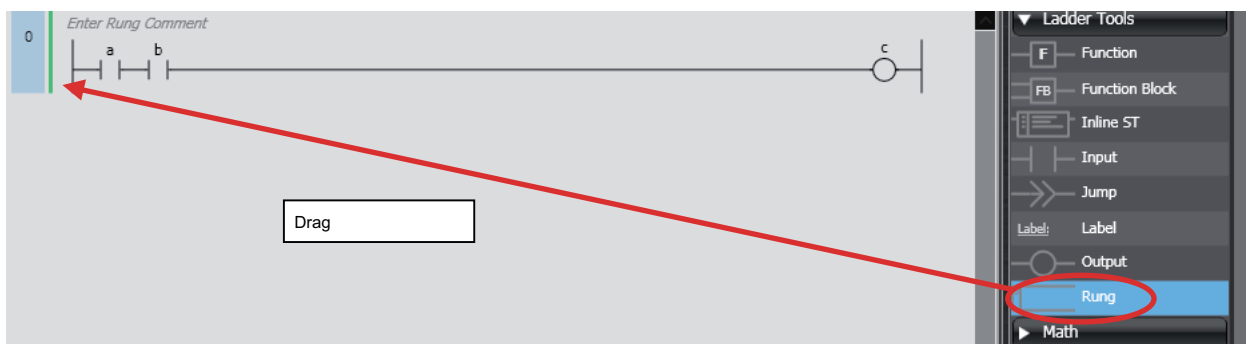

Method (2) Select the start of a rung and press the R Key. (Press the Shift + R Keys to insert a rung above the selected rung.)

Method (3) Right-click a rung and select Insert rung above or Insert rung below.



A rung is inserted above or below the selected rung.

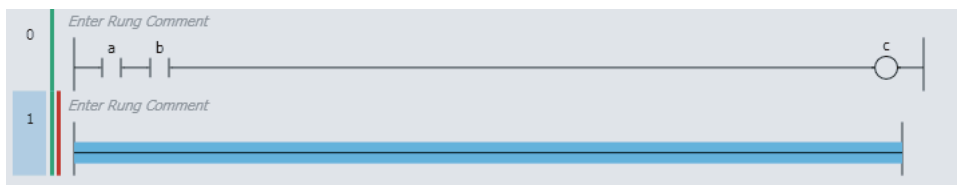

Inserting and Deleting Inline ST

- Inserting Inline ST

You can insert a box in a ladder diagram to enable programming in ST. This allows you to include ST in a ladder diagram.



Precautions for Correct Use

- You can write up to 1,000 lines of code in an inline ST box. If you write more than 1,000 lines, an error is detected during the program check or when the user program is built.
- You can insert only one inline ST box per rung. If you insert more than one, an error is detected during the program check or when the user program is built.
- You cannot insert any circuit parts between an inline ST box and the right bus bar. If you insert one, an error is detected during the program check or when the user program is built.

- Inserting Inline ST

- 1 Right-click the connecting line where you want to insert the inline ST and select **Insert Inline ST** from the menu. Or, drag **Inline ST** under **Ladder Tools** in the Toolbox.

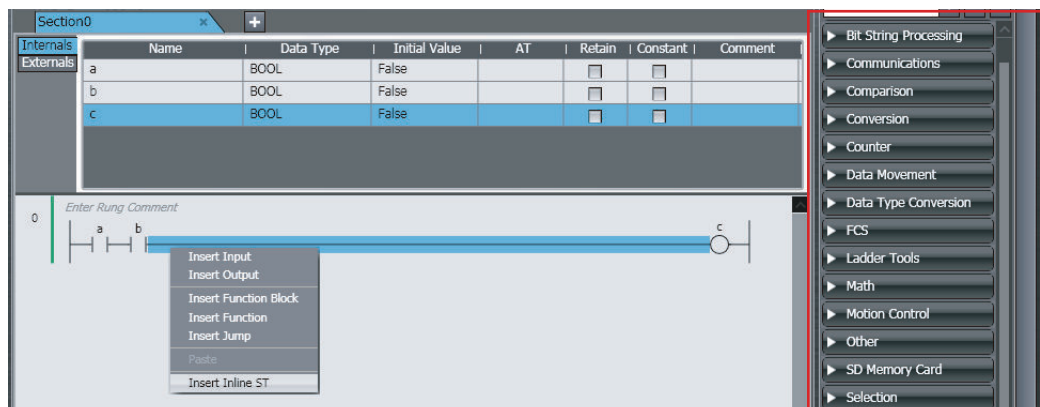

An inline ST box is inserted.

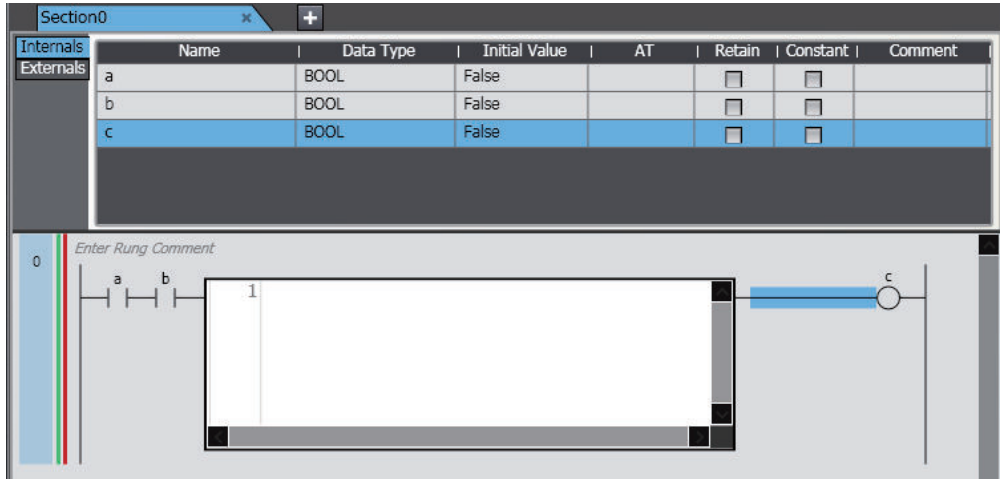

- 2** If there are any circuit parts between the inline ST box and the right bus bar, delete them. Refer to 4-6-2 *Basic ST Editor Operations* on page 4-153 for information on programming in ST.

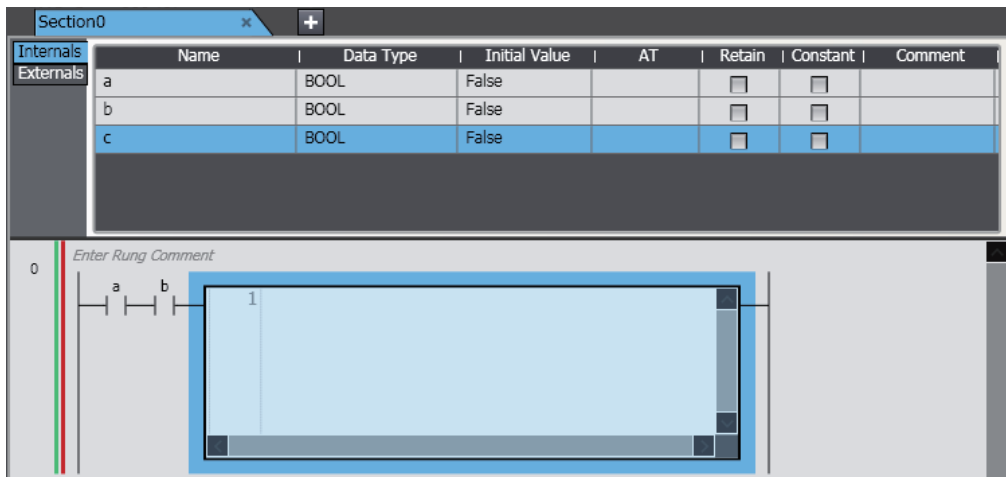

● Deleting an Inline ST Box

- 1** Right-click the inline ST box to delete and select **Delete** from the menu. Or, select the inline ST box and press the Delete Key.

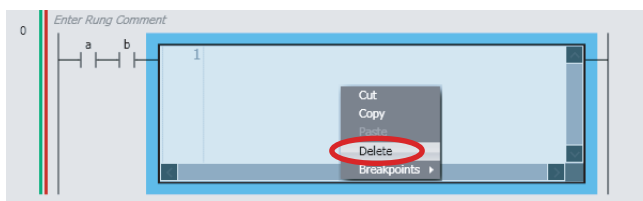

The inline ST box is deleted.

● Copying and Pasting Inline ST Boxes

- 1** Right-click the inline ST box to copy and select **Copy** from the menu.

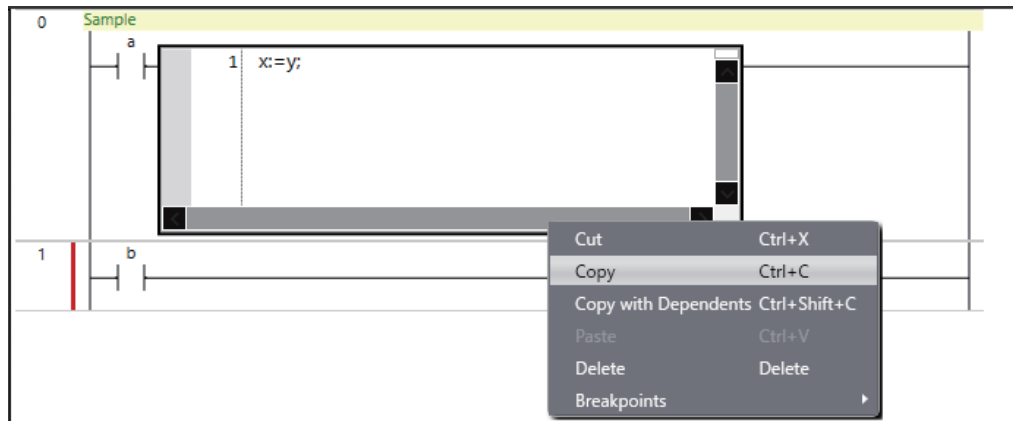

- 2** Right-click the connecting line where you want to paste the inline ST box and select **Paste** from the menu.

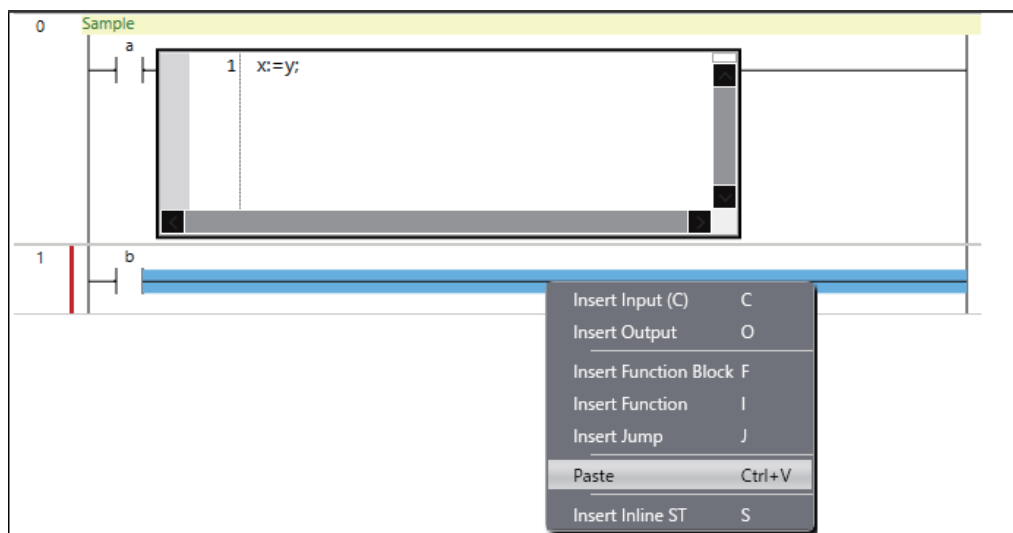

The inline ST box is pasted.

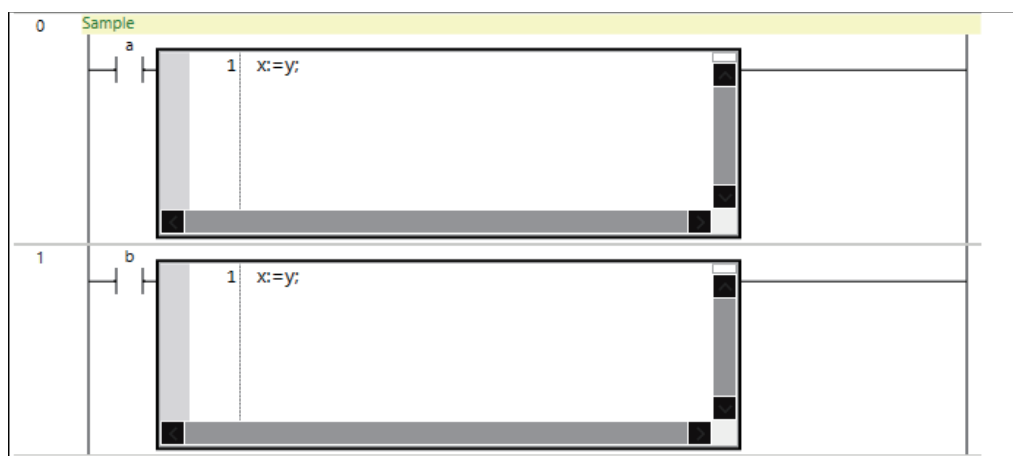

Additional Information

You can drag an inline ST box in the Ladder Editor to move it. Drag the inline ST box to the connecting line where you want to move it.

Copying and Pasting Circuit Parts

There are the following ways to copy circuit parts.

- **Copy:** Only circuit part data is copied.
- **Copy with Dependents:** Not only the circuit part data but also variables that are referenced by the circuit part and the data types of the variables are also copied.

If you paste the circuit part into another program, not only the circuit part data but also variables used in the circuit part and the data types of the variables are added to the program.

If a variable or data type with the same name and different attribute already exists in the destination program, the **Comparison before pasting dependents** Dialog Box is displayed.

For details on the **Comparison before pasting dependents** Dialog Box, refer to *4-7 Comparison before Pasting Dependents* on page 4-166.

● Copying and Pasting Program Inputs

- 1 Right-click the input to copy and select **Copy** from the menu. Or, select the input and press the Ctrl + C Keys. If you want to copy data together with referenced variables and their data types, select **Copy with Dependents**.

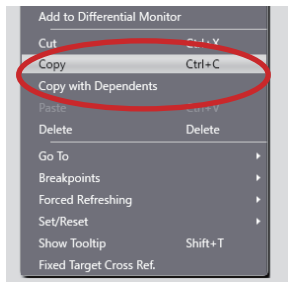

- 2 Right-click the connecting line where you want to paste the input and select **Paste** from the menu. To paste the input in an OR structure, right-click the input above the location where you want the OR structure and select **Paste** from the menu.

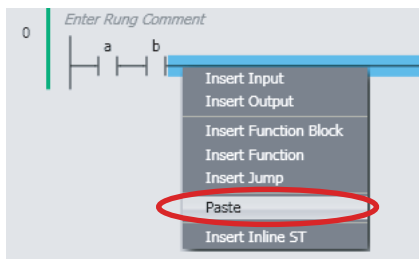

The input is pasted.

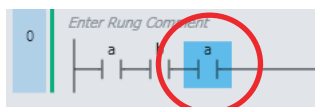

If an input is selected, the input is pasted under that input.

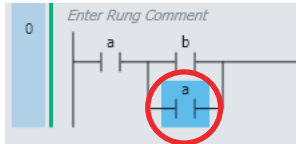

● Copying and Pasting Outputs

- 1 Right-click the output to copy and select **Copy** from the menu. Or, select the output and press the Ctrl + C Keys. If you want to copy data together with referenced variables and their data types, select **Copy with Dependents**.

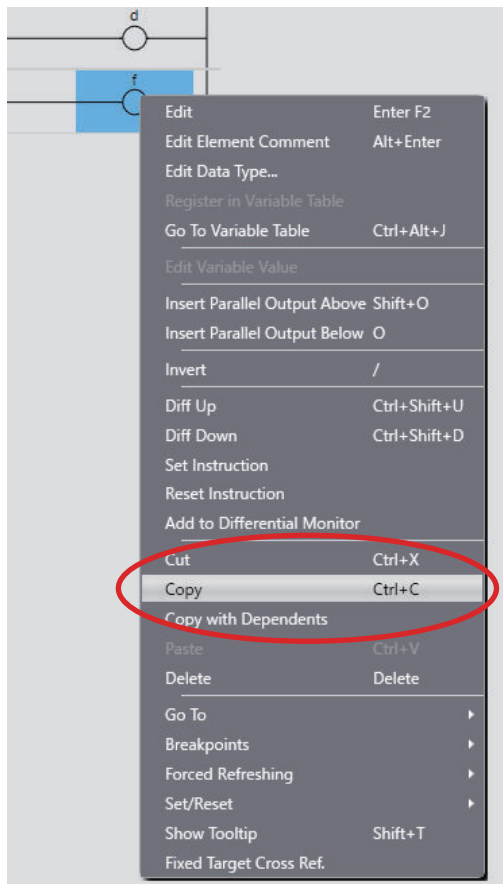

- 2 Right-click the connecting line where you want to paste the output and select **Paste** from the menu. To paste the output in an OR structure, right-click the output above the location where you want the OR structure and select **Paste** from the menu.

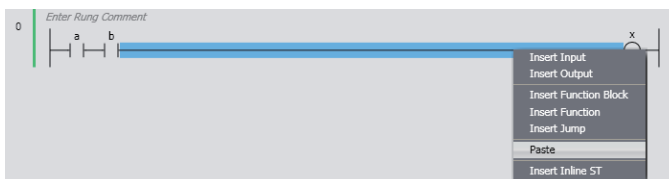

The output is pasted.



If an output is selected, the output is pasted under that output.



Precautions for Correct Use

After you paste a circuit part, check to be sure that the variables and their data types are used correctly.



Additional Information

You can select more than one circuit part at the same time. Either drag the cursor around the circuit parts to select, or click the circuit parts while holding down the Shift Key.

Moving Vertical Lines

Use the following procedure to change where a connecting line is connected.

- 1 Drag the connecting line to move as shown in the following figure.

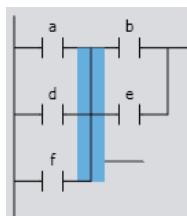

- 2 Release the mouse button at the new position for the connecting line. A pop-up menu is displayed.

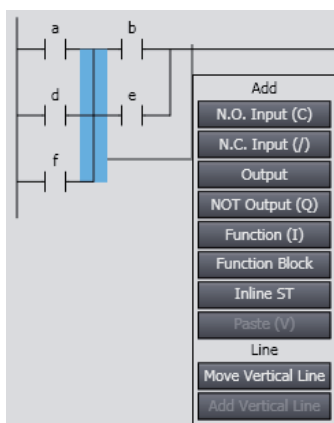

- 3 Select *Move Vertical Line*.

The ladder diagram changes.

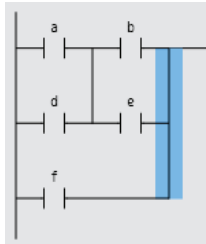

Inserting and Deleting Bookmarks

You can add bookmarks to the beginning of rungs and move between them.

- 1 Right-click the beginning of a rung and select **Bookmarks - Toggle Bookmark** from the menu.

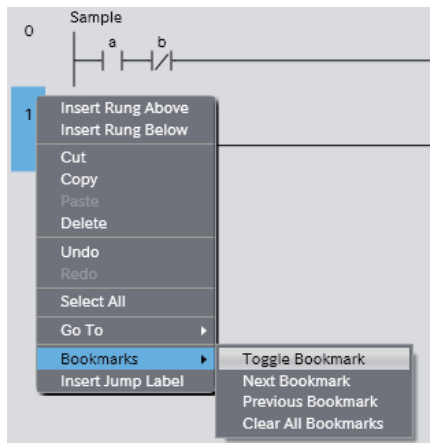

A bookmark is displayed at the beginning of the rung.



- 2 To delete a bookmark for a rung, right-click the beginning of a rung where you have set a bookmark and select **Bookmarks - Toggle Bookmark** from the menu just as you did to insert a new bookmark.
The bookmark for the selected rung is deleted.
- 3 To delete all bookmarks at once, right-click the beginning of a rung and select **Bookmarks - Clear All Bookmarks** from the menu.
All bookmarks are deleted.

Displaying Rung Errors

When you enter a circuit part, the format is always checked and any mistakes are displayed as errors. If there are any errors, a red line is displayed between the rung number and the left bus bar.

Error Rung



Place the mouse over the red line to view information on the rung error.

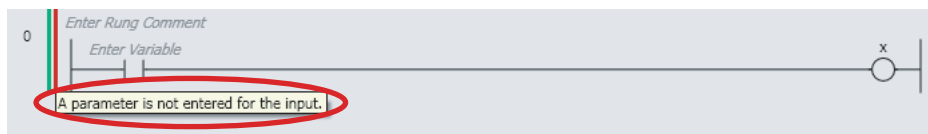

4-5-4 Editing Variables and Data Types in the Ladder Editor

Editing Variables

You can change the variables that are entered for program inputs, program outputs, and parameters to other variables.

Right-click a program input, program output, or parameter, and select **Edit** from the pop-up menu.

Displaying Suggestions for Variables

Entering a variable name, data type, or variable comment for an input, output, etc. displays a list of entry suggestions as shown below.

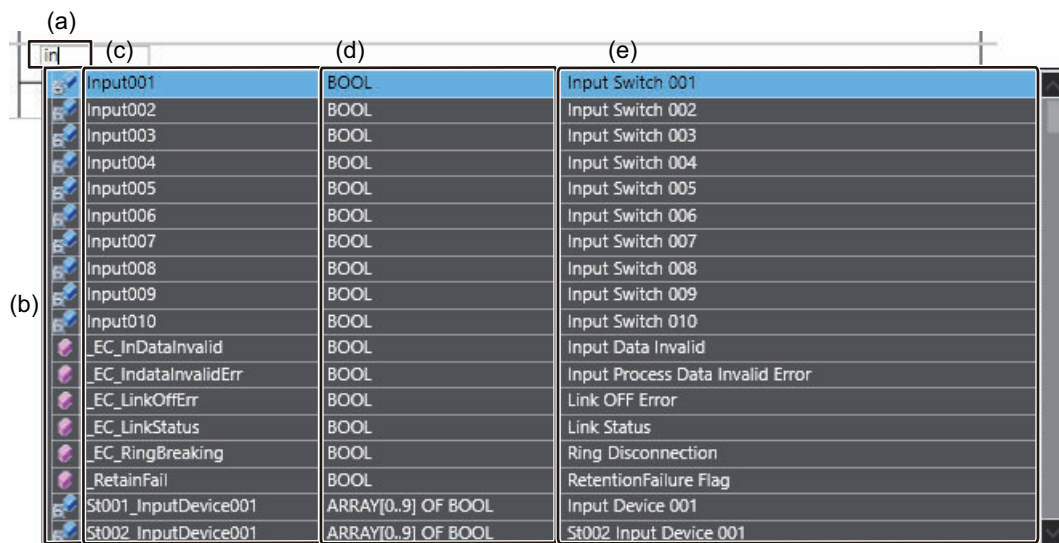

The following items are displayed.

	Item	Description
(a)	Entry field	Enter a string to narrow down possible variables. If you enter a string with two or more characters, the candidates displayed will be narrowed down by searching the variable name, data type, and variable comment columns.
(b)	Variable type	Displays icons to distinguish between local and global variables.
(c)	Variable name	Displays variable names.
(d)	Data type	Displays data types of variables.
(e)	Variable comment	Displays variable comments.

Registering Variables in Variable Table

You can register variables that are entered for program inputs, program outputs, and parameters in a variable table.

- 1 Right-click a variable that is not registered and select **Register in Variable Table** from the menu.

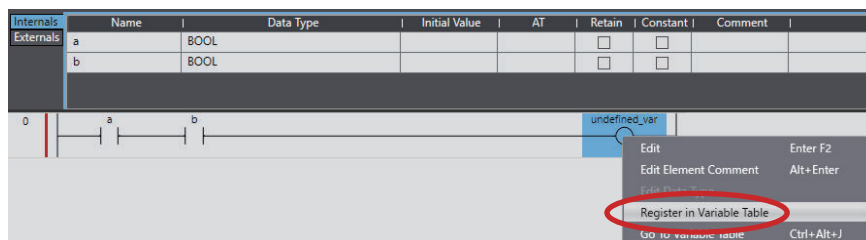

The **Select the variable type** Dialog Box is displayed.

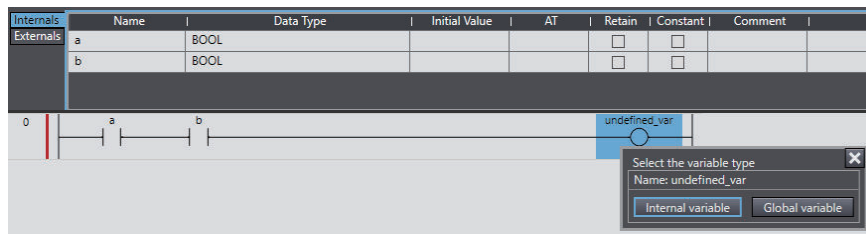

- 2 Select a variable type you want to register on the **Select the variable type** Dialog Box. If you entered a variable for a parameter, the **Enter the data type** Dialog Box is displayed. Enter a data type and press the Enter Key.
This completes the registration of a new variable in a local or global variable table.

Jumping to a Variable Table

You can display the variable table where a selected variable is registered and jump to the line for that variable.

Right-click a variable and select **Go To Variable Table** from the pop-up menu. Or, select the variable and press the Ctrl + Alt + J Keys.

Displaying and Editing Variable Comments

You can display and edit variable comments on the Ladder Editor.

● Displaying Variable Comments

To display variable comments, select **Option** from the **Tools** Menu and select the *Show comment* Check Box for variable comments before you display the Ladder Editor. Refer to *8-26 Sysmac Studio Option Settings* on page 8-166 for the procedure.

You can edit comments that can be edited by clicking them.



Additional Information

- You can display the comments for the global variables instead of the comments for the external variables. In the option settings, select the *Use global variable comment* Check Box under the variable comments in the ladder information. If you select the above check box, you cannot edit the comments of the external variables.
- You can display variable comments on more than one line. Specify the *number of display lines* for the variable comments in the ladder information in the option settings. When a comment does not fit in the display area, a part of comment that cannot be displayed will be omitted. You can select the omitted part from beginning, middle, or end of the comment in the option settings.

● Displaying Structure Variable Member Comments

Variable comments for structure variable members are displayed in the following form:

Structure_variable_comment Member_variable_comment (with a space between the two comments).

If the member variable comment is empty, the data type comment for that member is displayed instead of the *member variable comment*. If both the member variable comment and the data type comment are empty, only the structure variable comment is displayed.

● Displaying Union Variable Member Comments

Variable comments for union variable members are displayed. If the member variable comment is empty, the data type comment for that member is displayed. If both the member variable comment and the data type comment are empty, the union variable comment is displayed.

Searching for and Jumping to Variables in Ladder POUs

You can sequentially search for inputs, outputs, and instructions in ladder POUs that use a specified variable and sequentially jump to the locations where the variable is used.

- 1 Right-click a program input, program output, or variable, and select the destination to jump to from the menu.

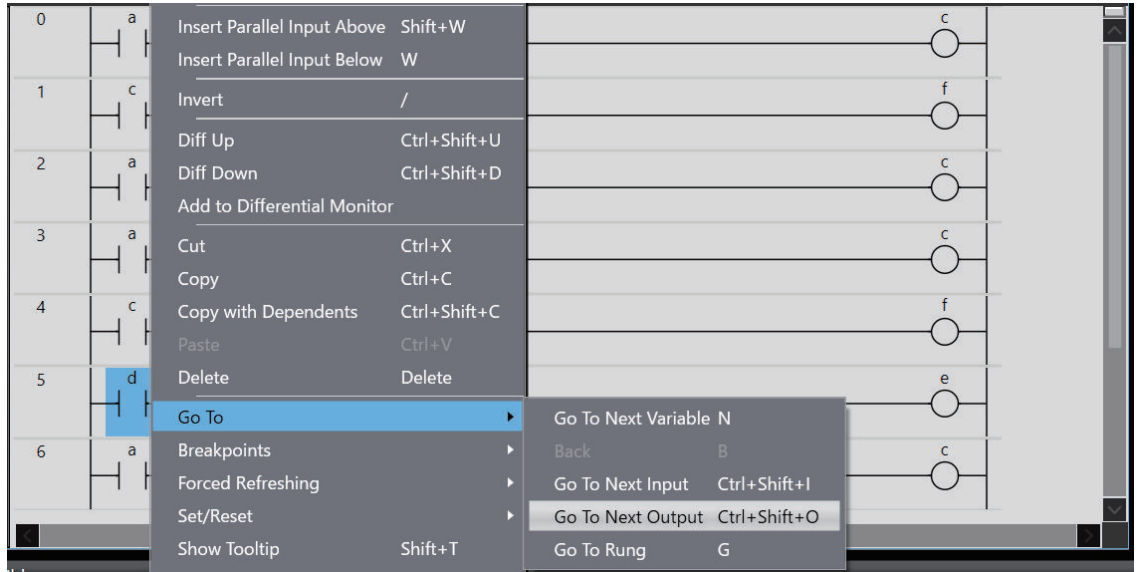

2 The display will jump to the location of the relevant variable.

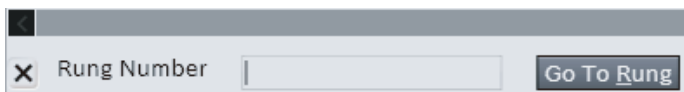

4

Menu command	Description
Go to Next Variable	The display will jump to the next location where the selected variable is used.
Back	The display will jump to the previous location where the selected variable is used.
Go to Next Input	The display will jump to the next program input or function/function block input parameter where the selected variable is used.
Go to Next Output	The display will jump to the next program output or function/function block output parameter where the selected variable is used.
Retrace Search*1	If the selected variable is used as a program output or as the output parameter of a function or function block, this command searches for the program inputs and the input parameters to functions or function blocks that use the selected variable. The display jumps sequentially to the locations where the variable was found starting from the first rung. If the selected variable is used as a program input or as the input parameter of a function or function block, this command searches for the program outputs and the output parameters to functions or function blocks that use the selected variable. The display jumps sequentially to the locations where the variable was found.
Go to Rung	The display will jump to the start of the specified rung. 

*1. This command is not displayed on the menu. Use the shortcut key (the Space Key). Shortcut keys are also convenient for other menu commands. Refer to A-6 *Shortcut Keys* on page A-25.

Editing Data Types

If you perform editing offline, you can change the data types of variables on the Ladder Editor.

- 1 Right-click a variable and select **Edit Data Type** from the pop-up menu.

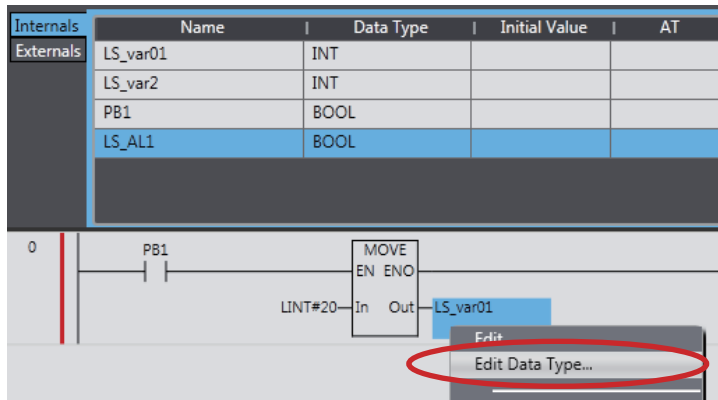

A dialog box is displayed for you to enter the data type.

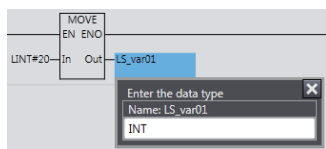

- 2 Enter the new data type and press the Enter Key.

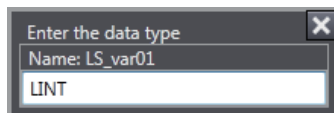

The data type of the variable is changed.

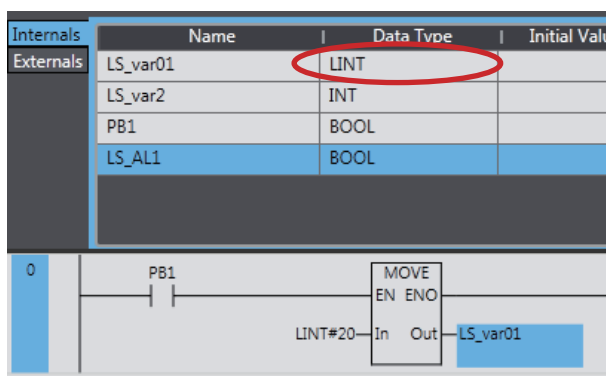

4-5-5 Operating Functions and Function Blocks in the Ladder Editor

Inserting Function Block Instructions and User-defined Function Blocks

You can use the following methods to insert function block instructions and user-defined function blocks (collectively called “function blocks” below).

Inserting Function Block Instructions

Method (1) Drag a function block instruction from the Toolbox.

Inserting User-defined Function Blocks and Function Block Instructions

Method (2) Drag a function block from the Toolbox.

Method (3) Right-click the desired location and select **Insert Function Block** from the menu.

Method (4) Move the cursor to the insertion position and press the F Key.

The procedures to insert the function block that is shown in the following figure are given below.

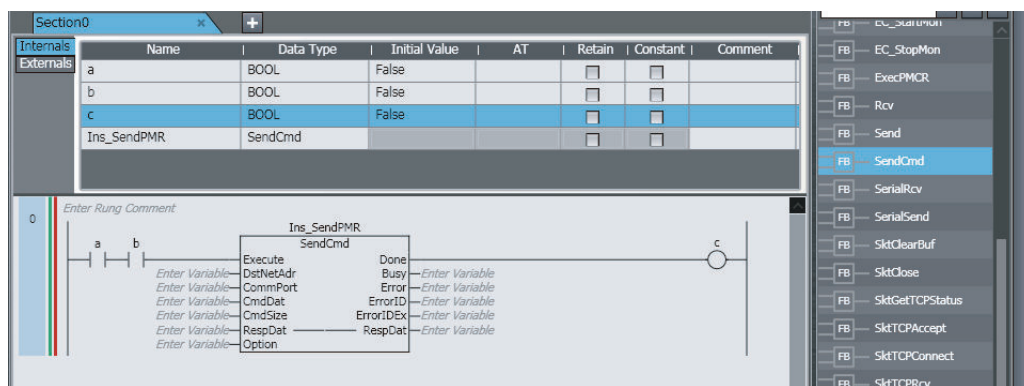

● Method (1) Dragging a Function Block Instruction from the Toolbox

- 1 Select **SendCmd** under **Communications** in the Toolbox and then drag it to the location where you want to insert it.

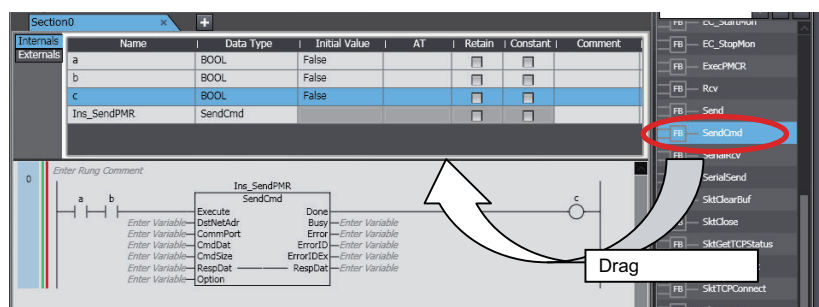

A rung for the **SendCmd** function block is inserted.

- 2 Click **Enter Function Block** at the top of the function block you inserted and enter an instance name for the function block. If the function block instance is registered in the local variable table, you can also select this instance.

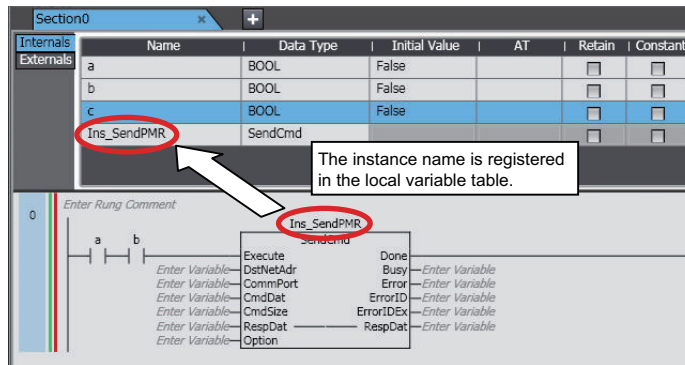

This completes the insertion of the function block.

If you entered a new instance name, it is registered in the local variable table.

● Method (2) Dragging a Function Block from the Toolbox

- 1 Select **Function Block** under **Ladder Tools** in the Toolbox and then drag it to the location where you want to insert it.

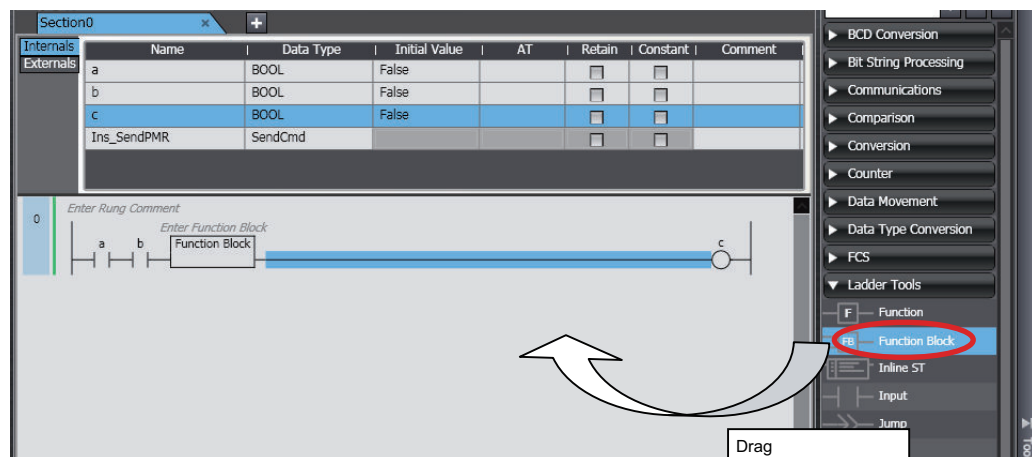

The function block is added to the rung.

- 2 Click **Function Block** for the inserted function block, and type the first character or press the Delete Key and then Ctrl + Space Keys. Select a function block or function block instruction from the list.

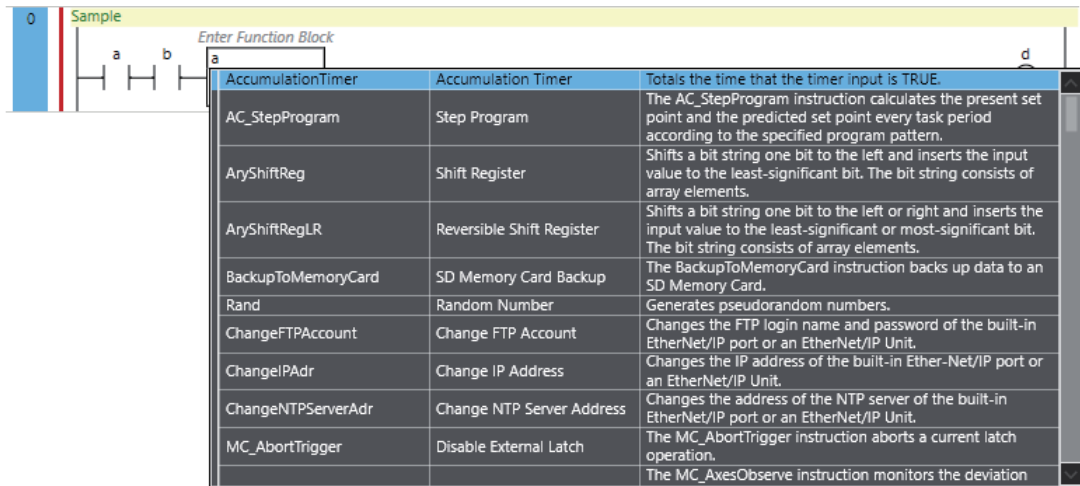

The selected function block is displayed.

- 3 Click **Enter Function Block** in the function block you inserted and enter an instance name for the function block. If the function block instance is registered in the local variable table, you can also select this instance.

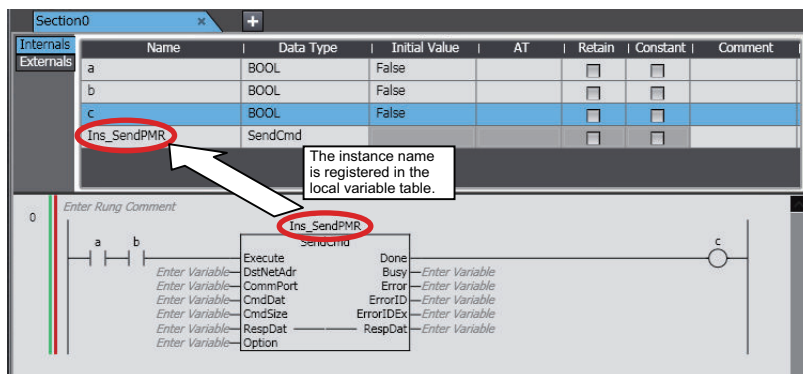

This completes the insertion of the function block. If you entered a new instance name, it is registered in the local variable table.

For the following methods 3 and 4, you first must register a function block definition as a data type in the local variable table.

- **Method (3) Right-clicking the Desired Location and Selecting Insert Function Block from the Menu**

- 1 Right-click a connecting line and select **Insert Function Block** from the menu.

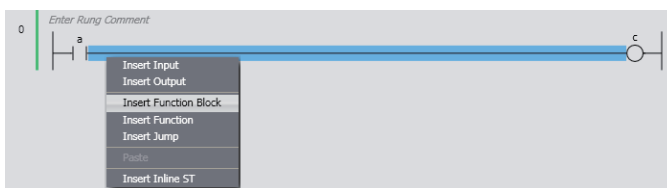

The function block is added.

- 2** Click **Enter Type Name** inside the function block you inserted and enter a definition name for the function block. Then, click **Enter Function Block** and enter an instance name for the function block. If the function block instance is registered in the local variable table, you can also select this instance.

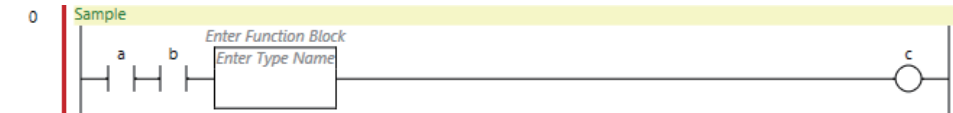

This completes the insertion of the function block.

If you entered a new instance name, it is registered in the local variable table.

● Method (4) Moving the Cursor to the Insertion Position and Pressing the F Key

Select the connecting line at the insertion location and press the F Key.

An empty function block is added.

The rest of the procedure is the same as for method 3.



Additional Information

You can insert a function block by dragging the mouse between two connecting lines. Select *Function Block* from the pop-up menu that is displayed when you release the mouse button.

Inserting Function Instructions and User-defined Functions

You can use the following methods to insert function instructions and user-defined functions (collectively called *functions* below).

Inserting Function Instructions

Method (1) Drag a function instruction from the Toolbox.

Inserting User-defined Functions and Function Instructions

Method (2) Drag a function from the Toolbox.

Method (3) Right-click the desired location and select **Insert Function** from the menu.

Method (4) Move the cursor to the insertion position and press the I Key.

The procedures to insert the function that is shown in the following figure are given below.

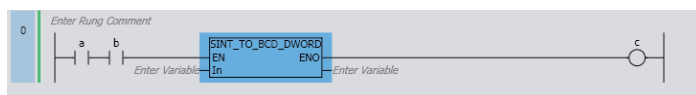

● Method (1) Dragging a Function Instruction from the Toolbox

Select **SINT_TO_DWORD** under **Data Type Conversion** in the Toolbox and then drag it to the location where you want to insert it. Or, right-click the desired location and select **Insert Function** from the menu. The function is inserted.

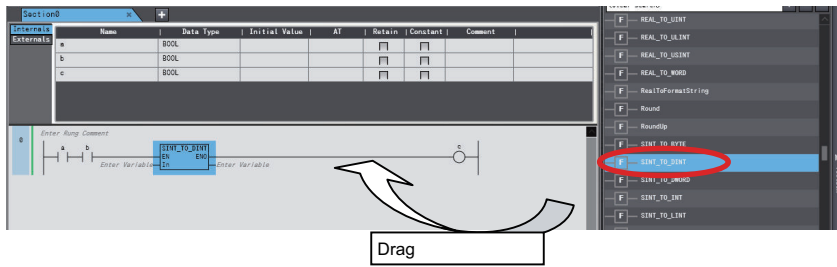

The selected function is inserted.

● **Method (2) Dragging a Function from the Toolbox**

- 1 Select **Function** from **Ladder Tools** in the Toolbox and then drag it to the location where you want to insert it.

The function is inserted.

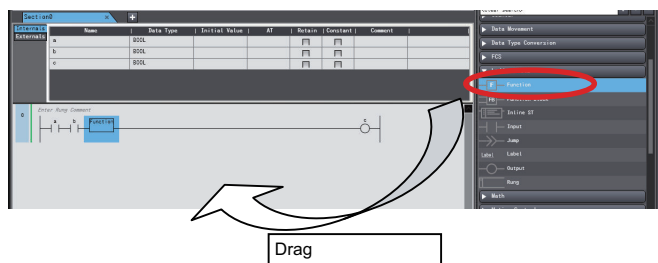

- 2 Click **Function** for the inserted function, and type the first character or press the Delete Key and then Ctrl + Space Keys. Select a function or function instruction from the list.

ScaleTrans	Scale Transformation	Converts input values from an input range to an output range.
SecToDate	Convert Seconds to Date	Converts the number of seconds from 00:00:00 on January 1, 1970 to a date.
SecToDt	Convert Seconds to Date and Time	Converts the number of seconds from 00:00:00 on January 1, 1970 to a date and time.
SecToTime	Convert Seconds to Time	Converts seconds to a time.
SecToTod	Convert Seconds to Time of Day	Converts the number of seconds from 00:00:00 to a time of day.
SEL	Binary Selection	Selects one of two selections.
SetABit	Set A Bit	Sets the specified bit in bit string data to TRUE.
SetAlarm	Create Userdefined Error	Creates a user-defined error.
SetBits	Set Bits	Sets consecutive bits in bit string data to TRUE.
SetBlock	Block Set	Moves the value of a variable or constant to one or more array elements.
SetInfo	Create Userdefined Information	Creates user-defined information.
SetTime	Set Time	Sets the system time.
SHL	N-bit Left Shift	Shifts a bit string by one or more bits to the left (toward the higher bits).
SHR	N-bit Right Shift	Shifts a bit string by one or more bits to the right (toward the lower bits).

The selected function is inserted.



Additional Information

You can connect multiple functions or function blocks together with connecting lines. For information on the possible connection forms, refer to information on ladder diagrams in the *NJ/NX-series CPU Unit Software User's Manual (Cat. No. W501)* or *NY-series Industrial Panel PC / Industrial Box PC Software User's Manual (Cat. No. W558)*.

● Method (3) Right-clicking the Desired Location and Selecting Insert Function from the Menu

- 1 Right-click a connecting line in the Ladder Editor and select **Insert Function** from the menu.

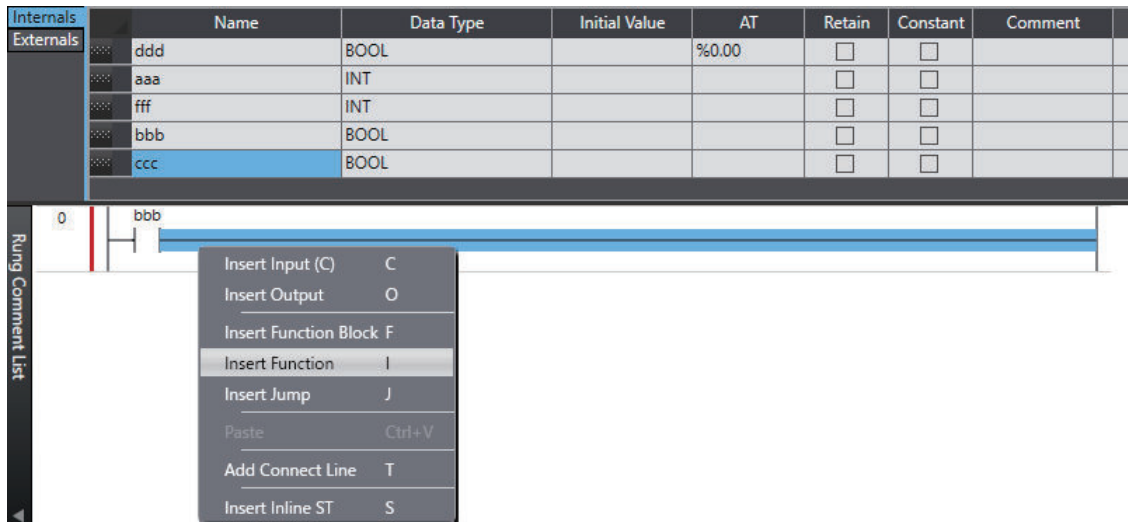

An empty function is added.

- 2 Enter the function name and select the specific function to use.

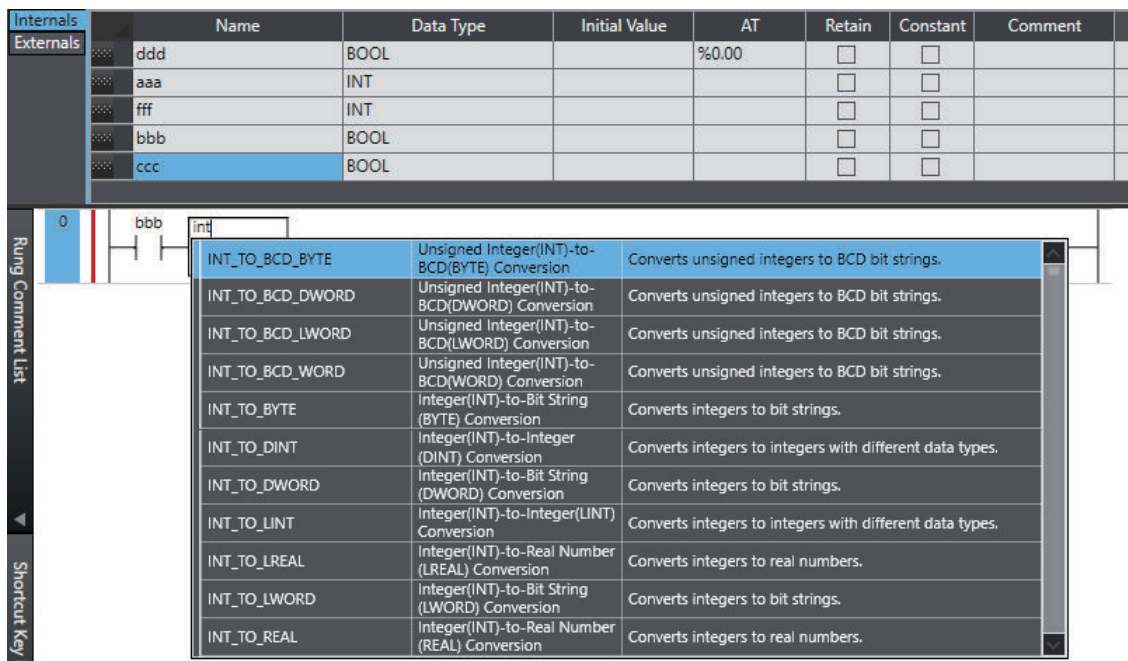

If you enter characters, registered functions that start with those characters are displayed.

● Method (4) Moving the Cursor to the Insertion Position and Pressing the I Key

- 1 Select the connecting line at the insertion location and press the I Key
An empty function is added.
The rest of the procedure is the same as for method 3.



Additional Information

You can insert a function by dragging the mouse between two connecting lines. Select *Function* from the pop-up menu that is displayed when you release the mouse button.

Deleting Function Block Instructions and User-defined Function Blocks

Right-click the function block instance to delete and select **Delete** from the menu. Or, select the function block instance and press the **Delete** Key.

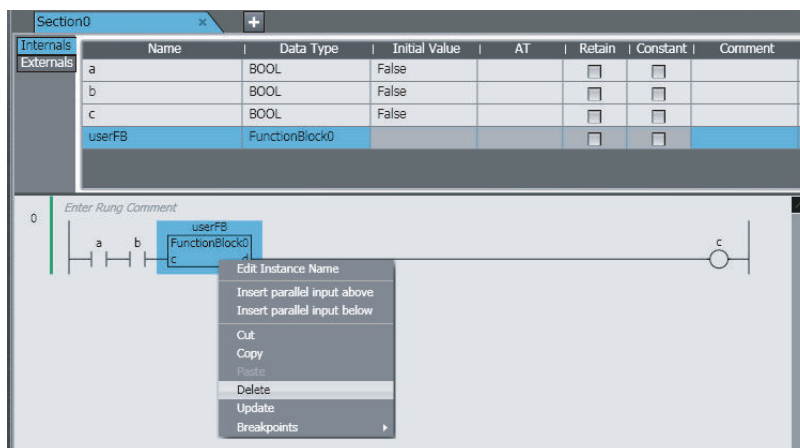

The selected function block instance is deleted. However, the variables used for parameters are not deleted.

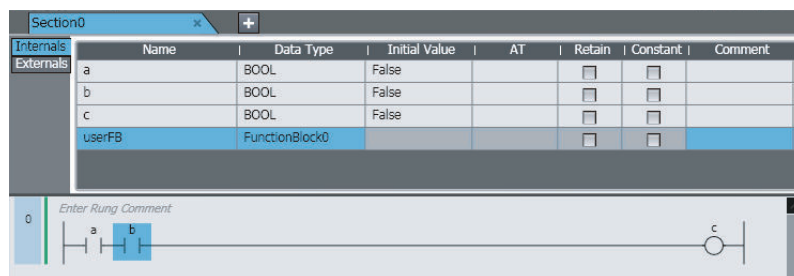

Deleting Function Instructions and User-defined Functions

- 1 Right-click the function to delete and select **Delete** from the menu. Or, select the function and press the **Delete** Key.

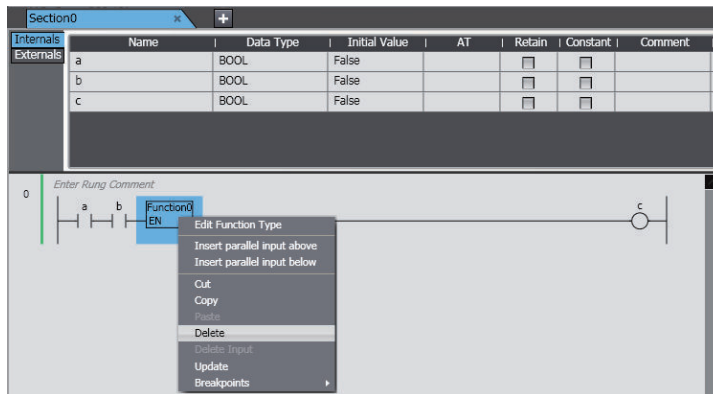

The selected function is deleted.
Variables used as parameters are not deleted.

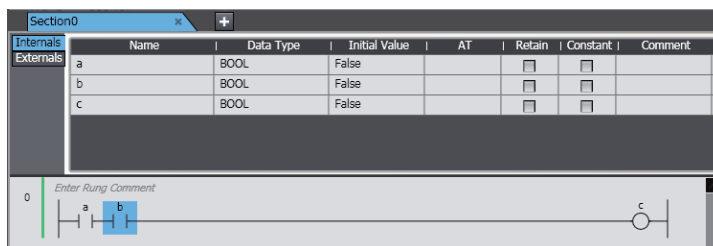

Additional Information

When you insert or delete circuit parts, connecting lines are automatically created to connect the circuit parts together.

Entering Parameters in Function Blocks

Use the following method to enter parameters into a function block that you have inserted.
All variables with the correct data type are displayed in the list.

Global Variables

Method (1) Select a variable that is registered in the global variable table from the list in the Ladder Editor.

Local Variables

Method (1) Select a variable that is registered in the local variable table from the list in the Ladder Editor.

Method (2) Drag a variable from the local variable table of the POUs to the Ladder Editor.

Method (3) Enter a variable in the Ladder Editor (or the ST Editor) before you register the variable in the local variable table.

The procedures to enter the variables that are shown in the following figure are given below.

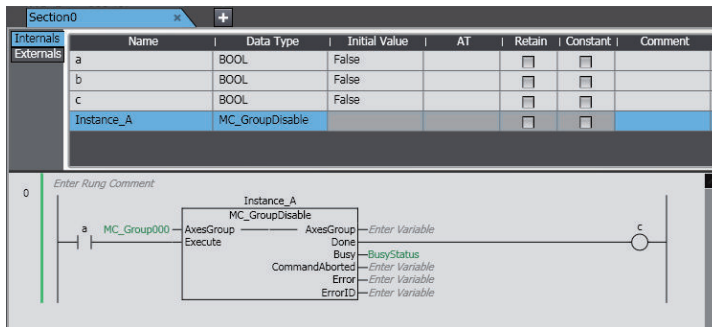

Method (1) Selecting a Variable in the Ladder Editor

Select the function block, click **Enter Variable**, type the first character or press the Ctrl + Space Keys, and select a variable from the list.

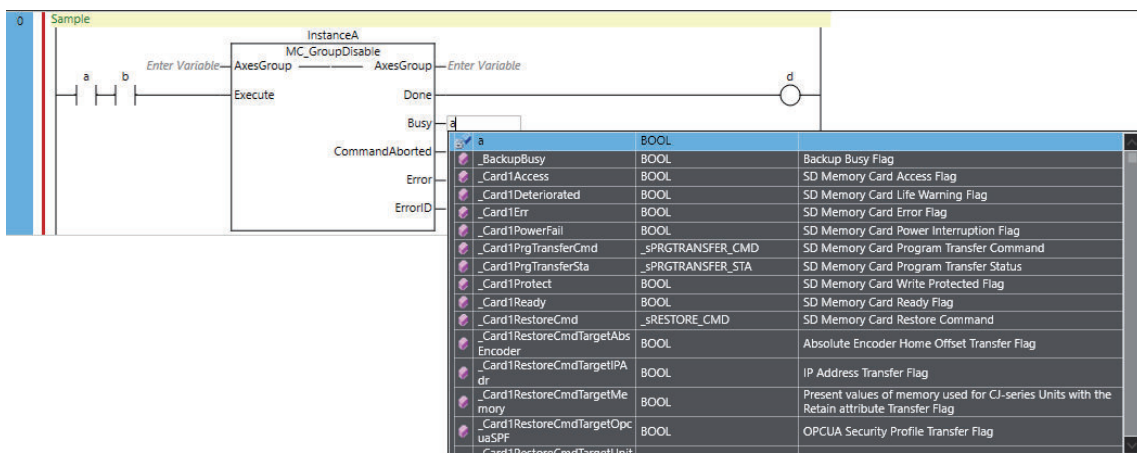

All variables with the correct data type are displayed in the list. The selected variable is entered into the function block.

Method (2) Dragging a Variable from the Local Variable Table of the POUs

Drag the variable you want from the local variable table to the function block parameter.

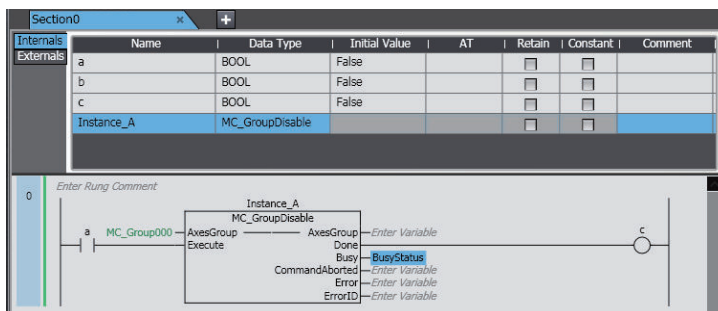

The variable is entered.

Method (3) Entering Variable Names Directly in the Ladder Editor or ST Editor

Enter a variable name directly before you register the variable in the local variable table.

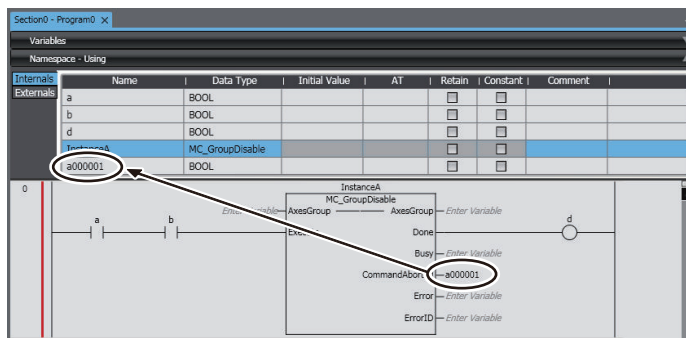

The variable is entered and registered in the local variable table.



Additional Information

- Members of derivative variables also appear in the list as long as they have the correct data type.
- You cannot view addresses in the Ladder Editor, only the variable names. You also cannot see if a variable has an AT specification.
- The variable names of any new variables that you enter in the Ladder Editor are automatically registered in the local variable table. You can select the **Select the internal or global variable** Check Box in the option settings and specify registering the variable in the global variable table. Refer to 8-26 *Sysmac Studio Option Settings* on page 8-166 for details.
- If you enter a new variable on the Ladder Editor, the data type for the parameter where you enter the variable is automatically entered. If the data type cannot be determined, a dialog box is displayed for you to enter the data type.
- Examples are given below of the notation to use to enter constants (literals) for the parameters of function blocks that you insert in a program.

a) *data_type_name#base#numeric_value*

Examples: Entering a hexadecimal number: INT#16#001A
 Entering a decimal number: INT#10#26
 Entering an octal number: INT#8#32
 Entering a binary number: INT#2#00011010

b) *data_type_name#numeric_value*

Example: INT#26

Note: In this case, the base is treated as a decimal number.

Refer to the *NJ/NX-series CPU Unit Software User's Manual (Cat. No. W501)* or *NY-series Industrial Panel PC / Industrial Box PC Software User's Manual (Cat. No. W558)* for details on the notation of constants (literals).

- If you select and right-click a function block instruction and select **Update** from the pop-up menu, differences between parameters of the function block definition and selected function block called are solved. For a user-defined function block, a message box appears to confirm whether to update all other function blocks called. The following conditions may cause differences between parameters of a function block definition and selected caller.
 - a) A user-defined instruction is used in a ladder program and then an in-out variable or return variable of the instruction is changed.
 - b) A system-defined instruction is used in a ladder program and then the Controller version is changed, which causes instruction parameter to change.
- If you move the mouse over a variable that you entered or select **Show Tooltip**, supplemental information on the variable is displayed in the tooltip. Refer to *Show Tooltip* on page 4-141 for detail.

Entering Parameters in Functions

Use the following method to enter parameters into a function that you have inserted. All variables with the correct data type are displayed in the list.

Global Variables

Method (1) Select a variable that is registered in the global variable table from the list in the Ladder Editor.

Local Variables

Method (1) Select a variable that is registered in the local variable table from the list in the Ladder Editor.

Method (2) Drag a variable from the local variable table of the POU to the Ladder Editor.

Method (3) Enter a variable in the Ladder Editor (or the ST Editor) before you register the variable in the local variable table.

The procedures to enter the variables that are shown in the following figure are given below.

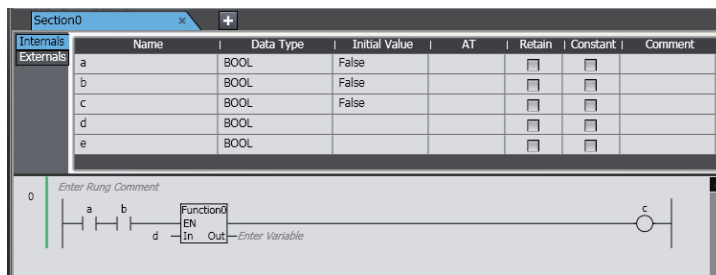

Method (1) Selecting a Variable in the Ladder Editor

Select the function, click **Enter Variable**, type the first character or press the Ctrl + Space Keys, and select a variable from the list.

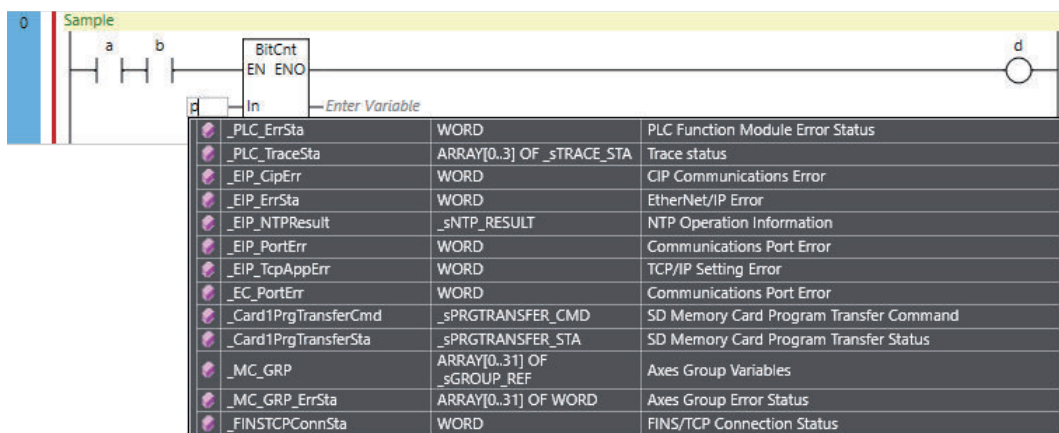

All variables with the correct data type are displayed in the list. The selected variable is entered into the function.

Method (2) Dragging a Variable from the Local Variable Table of the POU

Drag the variable you want from the local variable table to the function parameter.

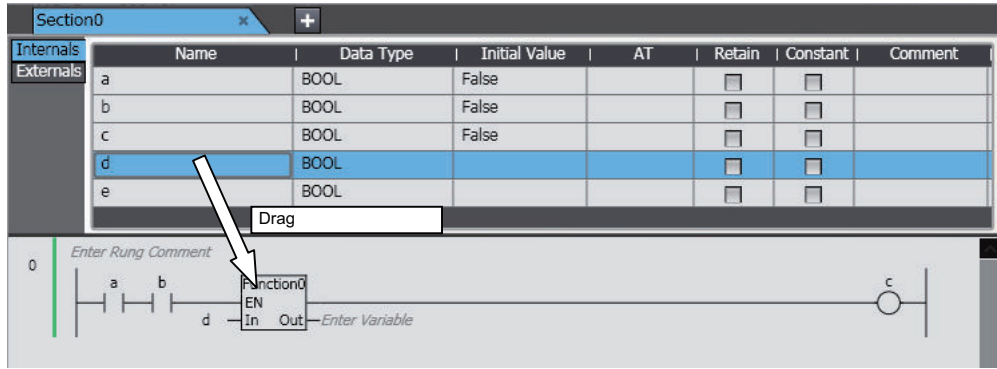

The variable is entered.

Method (3) Entering Variable Names Directly in the Ladder Editor or ST Editor

Enter a variable name directly before you register the variable in the local variable table.

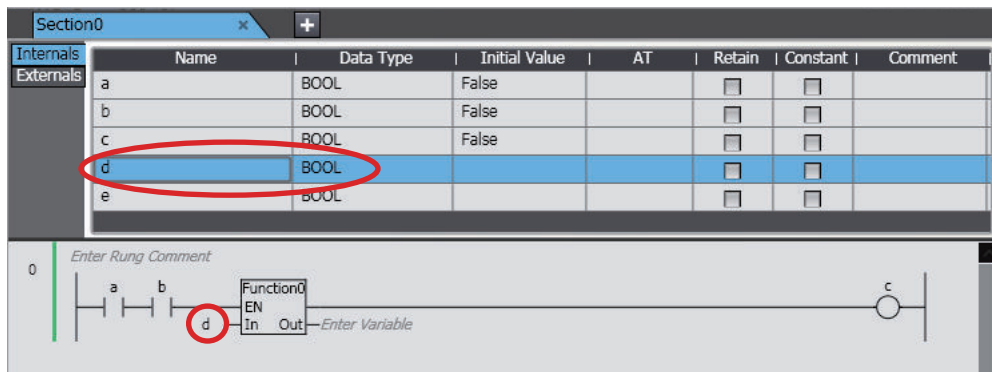

The variable is entered and registered in the local variable table.



Additional Information

- Members of derivative variables also appear in the list as long as they have the correct data type.
- You cannot view addresses in the Ladder Editor, only the variable names. You also cannot see if a variable has an AT specification.
- The variable names of any new variables that you enter in the Ladder Editor are automatically registered in the local variable table. You can select the **Select the internal or global variable** Check Box in the option settings and specify registering the variable in the global variable table. Refer to *8-26 Sysmac Studio Option Settings* on page 8-166 for details.
- If you enter a new variable on the Ladder Editor, the data type for the parameter where you enter the variable is automatically entered. If the data type cannot be determined, a dialog box is displayed for you to enter the data type.
- Examples are given below of the notation to use to enter constants (literals) for the parameters of functions that you insert in a program.
 - a) *data_type_name#base#numeric_value*

Examples: Entering a hexadecimal number: INT#16#001A
 Entering a decimal number: INT#10#26
 Entering an octal number: INT#8#32
 Entering a binary number: INT#2#00011010
 - b) *data_type_name#numeric_value*
 Example: INT#26
 Note: In this case, the base is treated as a decimal number.
 Refer to the *NJ/NX-series CPU Unit Software User's Manual (Cat. No. W501)* or *NY-series Industrial Panel PC / Industrial Box PC Software User's Manual (Cat. No. W558)* for details on the notation of constants (literals).
- If you select and right-click a function instruction and select **Update** from the pop-up menu, differences between parameters of the function definition and selected function called are solved. For a user-defined function, a message box appears to confirm whether to update all other functions called.
 The following conditions may cause differences between parameters of a function definition and selected caller.
 - a) A user-defined instruction is used in a ladder program and then an in-out variable or return variable of the instruction is changed.
 - b) A system-defined instruction is used in a ladder program and then the Controller version is changed, which causes instruction parameter to change.
- If you move the mouse over a variable that you entered or select **Show Tooltip**, supplemental information on the variable is displayed in the tooltip. Refer to *Show Tooltip* on page 4-141 for detail.

Displaying Suggestions for Function or Function Block Names

Entering a function or function block name, instruction name, or instruction description displays a list of suggestions as shown below.

(a)	(b)	(c)	(d)
StackDel	Delete from Stack	Deletes a value from a specified position in a stack.	Deletes a value from a specified position in a stack.
StackFIFO	First In First Out	Removes the bottom value from a stack.	Removes the bottom value from a stack.
StackIns	Insert into Stack	Inserts a value at a specified position in a stack.	Inserts a value at a specified position in a stack.
StackLIFO	Last In First Out	Removes the top value from a stack.	Removes the top value from a stack.
StackPush	Push onto Stack	Stores a value in a stack.	Stores a value in a stack.
StringCRC16	Calculate Text String CRC-16	Calculates the CRC-16 value using the MODBUS method.	Calculates the CRC-16 value using the MODBUS method.
StringCRCCITT	Calculate Text String CRC-CCITT	Calculates the CRC-CCITT value using the XMODEM method.	Calculates the CRC-CCITT value using the XMODEM method.
StringLRC	Calculate Text String LRC	Calculates the LRC value (horizontal parity).	Calculates the LRC value (horizontal parity).
StringSum	Checksum Calculation	Calculates the checksum for a text string.	Calculates the checksum for a text string.
StringToAry	Text String-to-Array Conversion	Converts a text string to a BYTE array.	Converts a text string to a BYTE array.
StringToFixNum	Text String-to-Fixed-decimal Conversion	Converts a decimal text string to a signed fixed-decimal number.	Converts a decimal text string to a signed fixed-decimal number.
STRING_TO_BYTE	Text String (STRING)-to-Bit String (BYTE) Conversion	Converts text strings to bit strings.	Converts text strings to bit strings.
STRING_TO_DINT	Text String (STRING)-to-Integer (DINT) Conversion	Converts text strings to integers.	Converts text strings to integers.
STRING_TO_DWORD	Text String-to-Bit String (DWORD) Conversion	Converts text strings to bit strings.	Converts text strings to bit strings.
STRING_TO_INT	Text String (STRING)-to-Integer (INT) Conversion	Converts text strings to integers.	Converts text strings to integers.

The following items are displayed.

	Item	Description
(a)	Entry field	Enter a string to narrow down the displayed candidates to instruction words that contain the string. If the entered string is two or more characters in length, the candidates displayed will be narrowed down by searching the instruction words, instruction name, and instruction description fields.
(b)	Instruction	Displays instruction words used in a program.
(c)	Instruction name	Displays instruction names.
(d)	Instruction description	Displays descriptions on instructions.

Inverting Inputs to Function Blocks

- 1 Right-click a BOOL input variable name in the function block and select **Toggle Negate** from the menu.

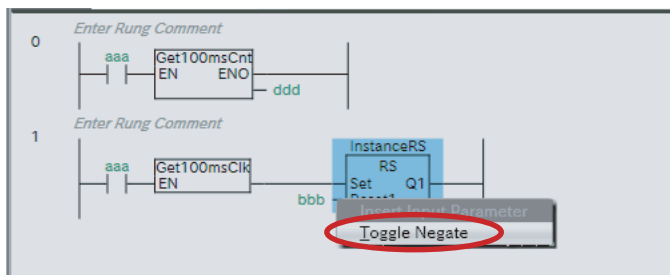

The input for the selected parameter is inverted.

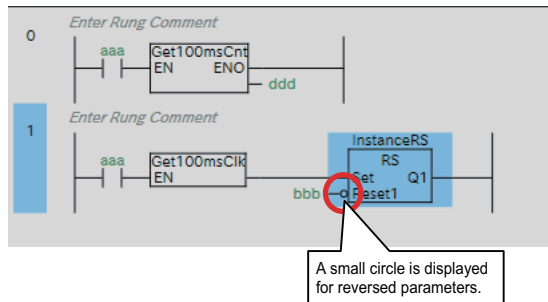

Copying and Pasting Functions and Function Blocks

There are the following ways to copy functions or function blocks.

- **Copy:** Only function or function block data is copied.
- **Copy with Dependents:** Not only function or function block data but also variables that are referenced by the function or function block and the data types of the variables are copied. If you paste the function or function block into another program, not only the function or function block data but also variables used in the function or function block and the data types of the variables are added to the program.

If a variable or data type with the same name and different attribute already exists in the destination program, the **Comparison before pasting dependents** Dialog Box is displayed.

For details on the **Comparison before pasting dependents** Dialog Box, refer to *4-7 Comparison before Pasting Dependents* on page 4-166.

● Copying and Pasting Function Blocks

- 1 Right-click the function block instance to copy and select **Copy** from the menu. Or, select the function block instance and press the Ctrl + C Keys. If you want to copy data together with referenced variables and their data types, select **Copy with Dependents**.

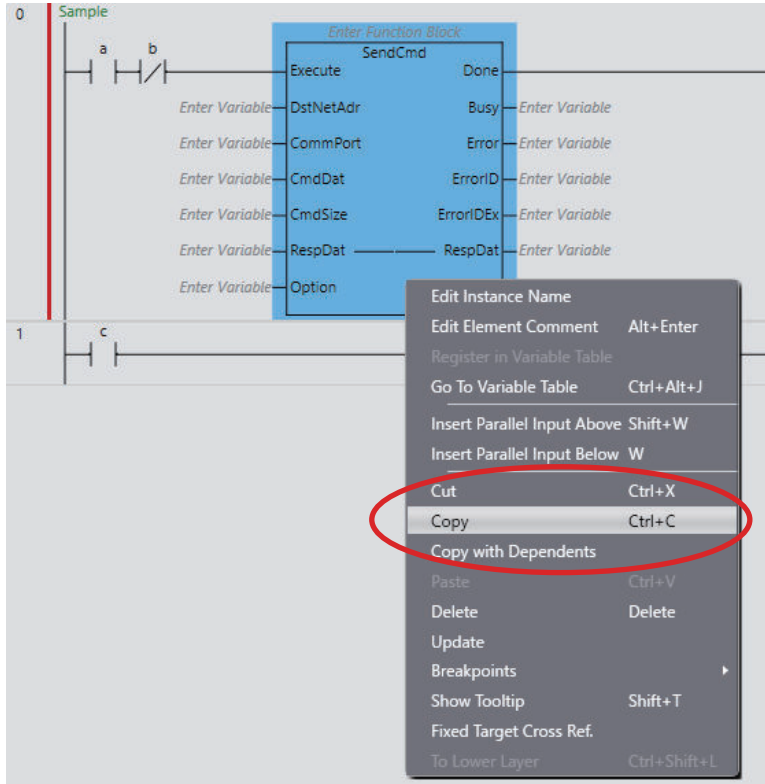

- 2 Right-click the connecting line where you want to paste the function block instance and select **Paste** from the menu. To paste the function block instance in an OR structure, right-click the circuit part above the location where you want the OR structure and select **Paste** from the menu.

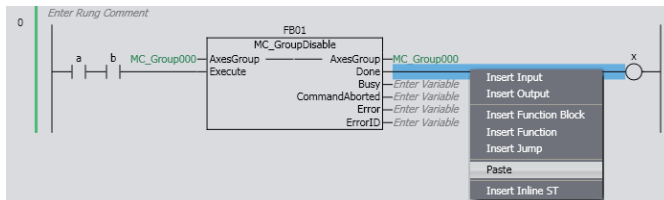

The function block instance is pasted.

Any variables assigned to parameters for the function block instance are also pasted.

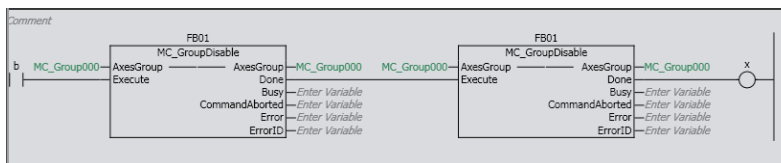

If a circuit part is selected, the function block instance is pasted under that circuit part.

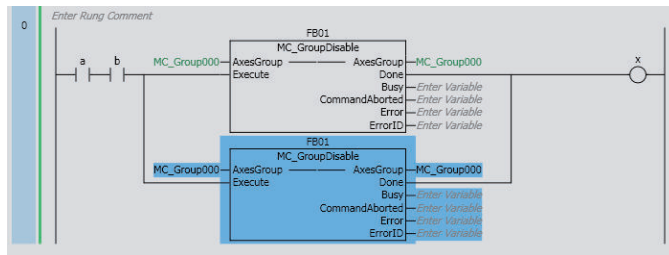

● Copying and Pasting Functions

- 1 Right-click the function to copy and select **Copy** from the menu. Or, select the function and press the Ctrl + C Keys. If you want to copy data together with referenced variables and their data types, select **Copy with Dependents**.

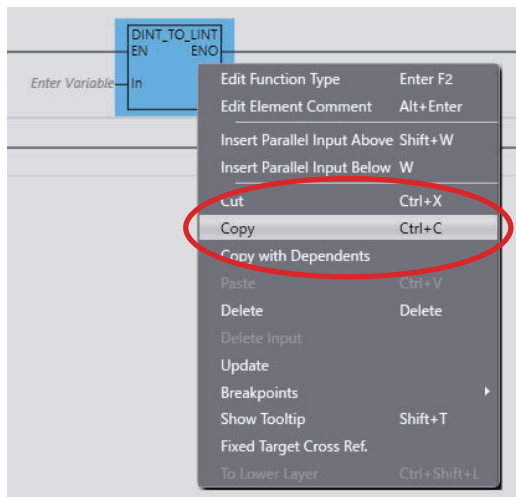

- 2 Right-click the connecting line where you want to paste the function and select **Paste** from the menu. To paste the function in an OR structure, right-click the circuit part above the location where you want the OR structure and select **Paste** from the menu.

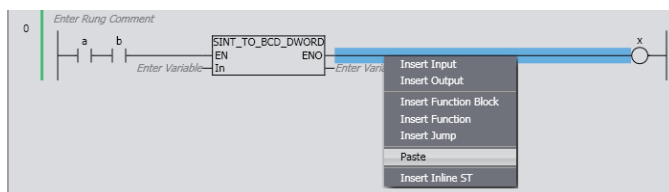

The function is pasted.

Any variables assigned to parameters for the function are also pasted.

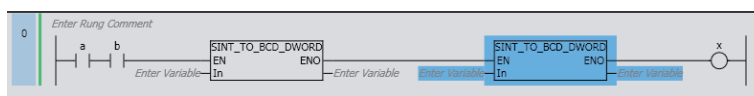

If a circuit part is selected, the function is pasted under that circuit part.

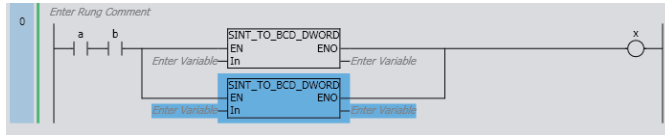

Precautions for Correct Use

After you paste a circuit part, check to be sure that the variables and their data types are used correctly.



Additional Information

You can select more than one circuit part at the same time. Either drag the cursor around the circuit parts to select, or click the circuit parts while holding down the Shift Key.

Displaying the Contents of User-defined Functions and Function Blocks

You can display the contents of a user-defined function or function block from a ladder program.

- 1 Right-click the user-defined function or function block name in the ladder program and select **To Lower Layer**. You can also double-click the name.

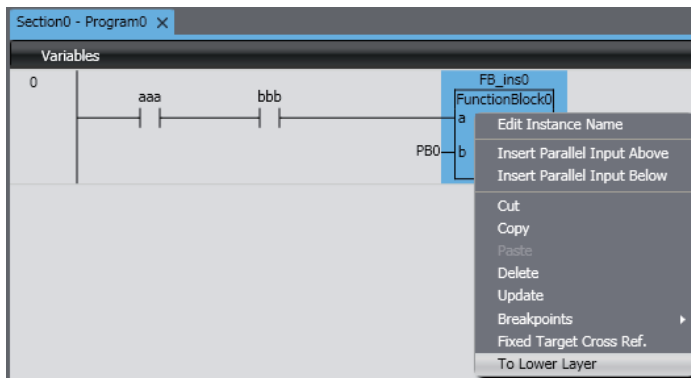

The contents of the function or the definition of the function block is displayed.

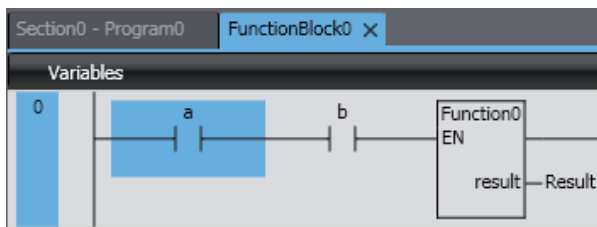

- 2 To return from the displayed function or function block definition to the original ladder program, right-click on the function or function block definition and select **To Upper Layer**.

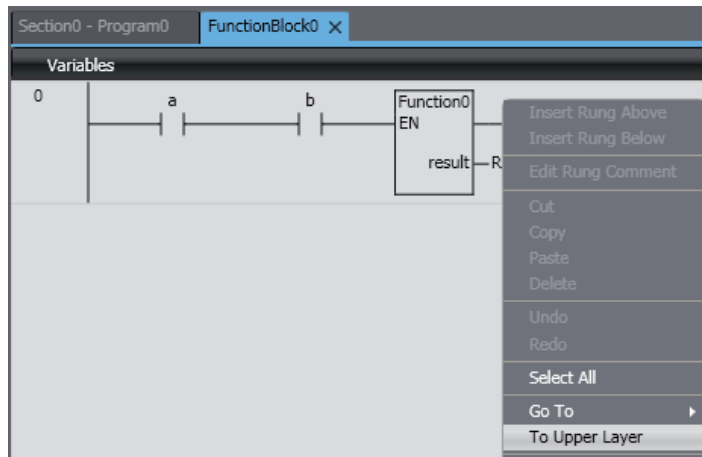

The original ladder program is displayed.



Additional Information

- You cannot use the **To Lower Layer** menu command to display the contents of a function or the definition of a function block in the following cases.
 - a) The function or function block is defined in a library that is set so that you cannot display the source.
 - b) The maximum number of tabs are already displayed in the Edit Pane.
- You can select the **To Upper Layer** menu command only from a function or function block definition that you displayed with the **To Lower Layer** menu command. The **To Upper Layer** menu command is valid only while the tab page for the contents of the function or the definition of the function block is displayed. However, in the following cases, the contents of the original program is not displayed even if you select the **To Upper Layer** menu command.
 - a) The original program is defined in a library that is set so that you cannot display the source.
 - b) The maximum number of tabs are already displayed in the Edit Pane.
- If you display the same function block definition from more than one program and then select the **To Upper Layer** menu command from the function block definition, the program where you last selected the **To Lower Layer** menu command is displayed.
- If you select the **To Lower Layer** menu command while online, the contents of the function block instance are displayed instead of the function block definition. If you then display the same function block definition from a different instance, the display is overwritten. In that case, you can select the **To Upper Layer** menu command only from the function block instance where you last selected the **To Lower Layer** menu command.

4-5-6 Element Comments and Rung Comments

Entering Element Comments

Element comments can be set in the following circuit parts.

Inputs, coils, functions, function blocks, and jumps

Example:





Version Information

Element comments can be used in projects for the NX102 CPU Unit with unit version 1.31 or later, the NX502 CPU Unit with unit version 1.60 or later, and the NJ/NX/NY-series CPU Unit with unit version 1.19 or later.

● Adding and Changing Element Comments

To add or change element comments, select a circuit part to set an element comment and perform one of the following operations.

- Right-click the circuit part and select **Edit Element Comment**.
- Press the Alt + Enter Keys.



Additional Information

You can show or hide element comments and specify the number of lines to display in the option settings. Refer to *8-26 Sysmac Studio Option Settings* on page 8-166 for details.

Entering Rung Comments

You can add element comments to each rung.

- 1 Select the rung header and display the entry field with one of the following methods.
 - Right-click and select **Edit Rung Comment**.
 - Press the Enter Key.
 - Double-click the left mouse button.

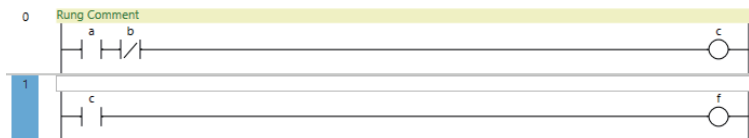

- 2 Enter a comment.



Additional Information

- You can change the Rung comment background color in the option settings. Refer to *8-26 Sysmac Studio Option Settings* on page 8-166 for details.
- You can start a new line by pressing the Ctrl + Enter Keys.

Displaying Rung Comment List

Rung Comment List is a list to display only rung comments in a Ladder Editor diagram. Rung comments enable you to understand the processing flow of ladder rungs and to identify a rung where you want to go. It can also display the rung comments hierarchically if you set a title.

- 1 Click the **Rung Comment List Bar**.
Or, right-click on the rung header and select **Display Rung Comment List**.

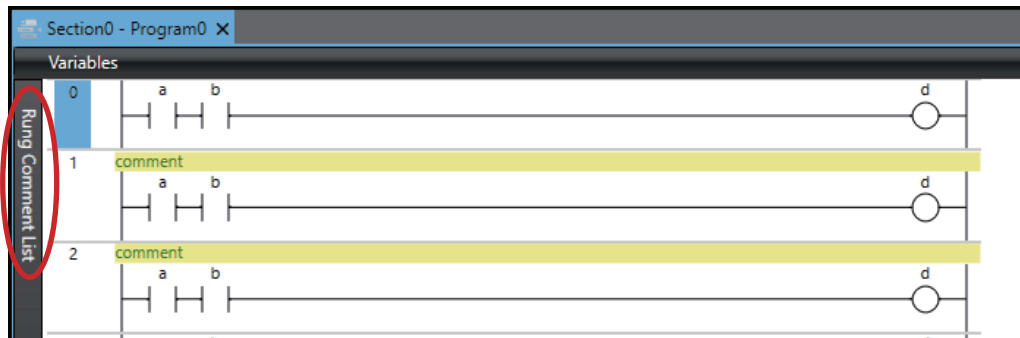

The rung comment list is displayed.

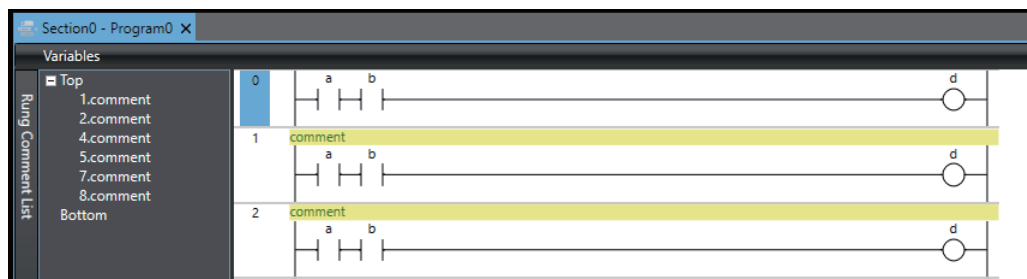

- 2 Double-click a comment.
Or, right-click and select **Jump** from the menu.

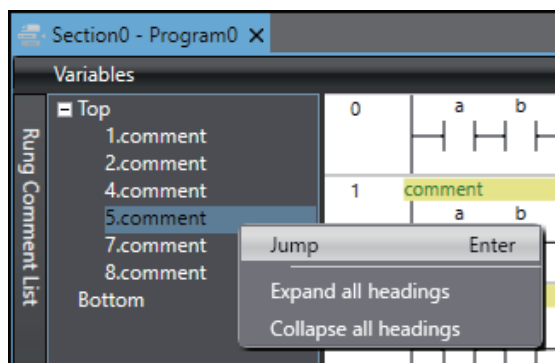

The target rungs are displayed on Ladder Editor.

● Setting Titles in Rung Comment List

- 1 Enter # in the beginning of a rung comment.



It is displayed as a title in Rung Comment List.

You can collapse the rung comments between the titles as the child elements of the title.

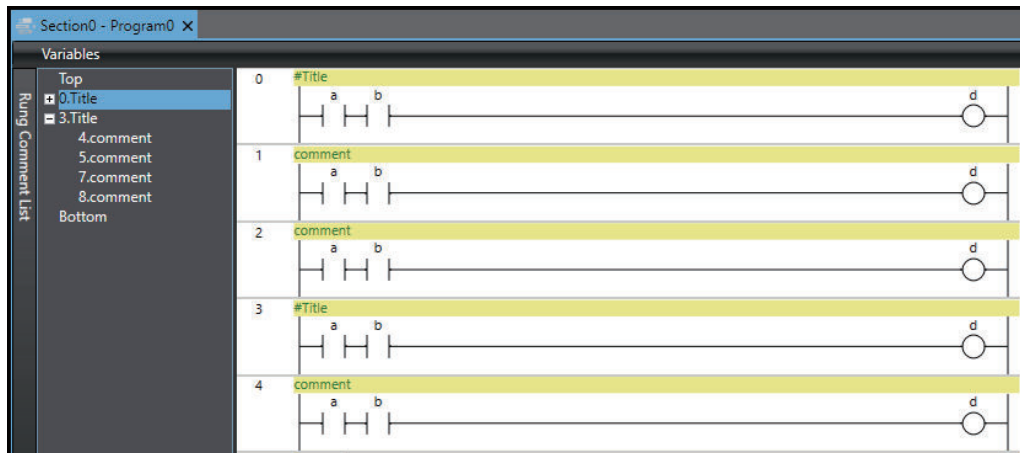

4-5-7 Inserting and Deleting Jump Labels and Jumps

You can insert a jump label in the rung to jump to and then specify the jump label when you insert a jump.

Inserting Jump Labels

- 1 Right-click the beginning of the rung to jump to and select **Insert Jump Label** from the menu.

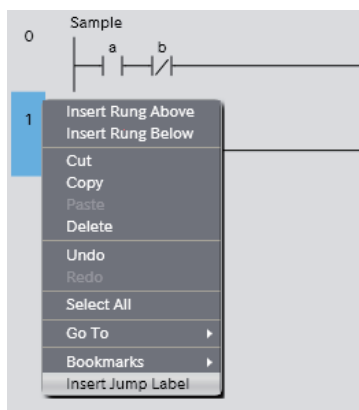

Or, drag a **Label** under **Ladder Tools** in the **Toolbox** to the beginning of the rung. A jump label entry field is inserted.

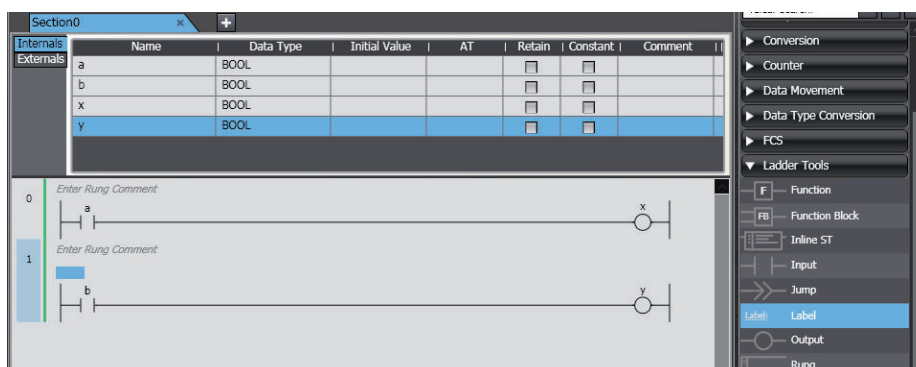

- 2 Enter the name of the jump label.

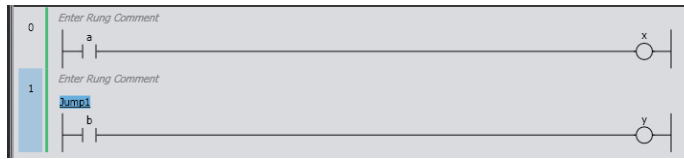

Inserting Jumps

- 1 Right-click the connecting line immediately before or after the output for the rung to jump from and select **Insert Jump** from the menu. Or, drag a **Jump** under **Ladder Tools** in the Toolbox to the connecting line.

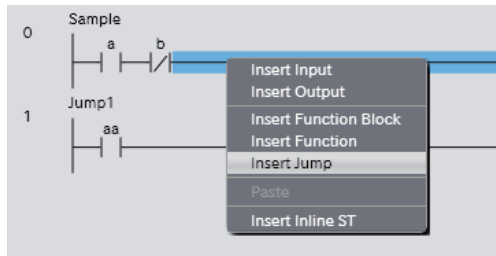

A jump circuit part is displayed.



Precautions for Correct Use

All circuit parts to the right of where you insert a jump are deleted.

Internals	Name	Data Type	Initial Value	AT	Retain	Constant	Comment
Externals	a	BOOL			<input type="checkbox"/>	<input type="checkbox"/>	
	b	BOOL			<input type="checkbox"/>	<input type="checkbox"/>	
	x	BOOL			<input type="checkbox"/>	<input type="checkbox"/>	
	y	BOOL			<input type="checkbox"/>	<input type="checkbox"/>	

- 2 Click **Enter Jump Label** for the jump circuit part and enter the name of the label to jump to.

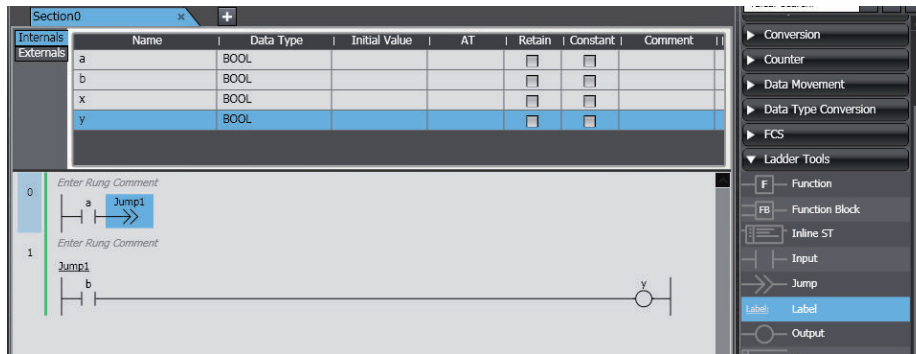

Deleting Jump Labels and Jumps

- 1 Right-click the jump you want to delete and select **Delete** from the menu. Or, select the jump and press the Delete Key.



The jump is deleted.

The right bus bar is displayed where the jump was deleted.



- 2 Select the connecting line to the left of the right bus bar and insert an output, function, or function block to construct the rung.

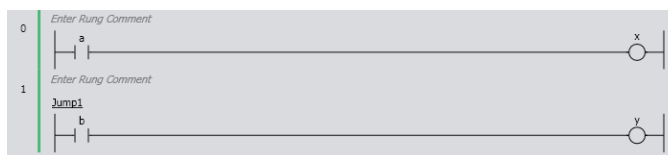

Deleting Jump Labels

- 1 Right-click the jump label you want to delete and select **Delete** from the menu. Or, select the jump label and press the Delete Key.



The jump label is deleted.



4-5-8 Customizing the View

Show Tooltip

If you move the mouse over a variable that you entered or execute the **Show Tooltip** menu, supplemental information on the variable is displayed in the tooltip.

Attributes of variables	Displayed information
Name	The variable name is displayed.
Data type	The data type is displayed.
AT	<i>Entered</i> is displayed if an address is allocated to the variable. Refer to the variable table for details on the AT specification.
Initial value	The set initial value is displayed. <i>Entered</i> is displayed if the variable cannot be identified because the data type is the derivative data type. Refer to the variable table for details on the initial value.
Retain	The Retain attribute setting is displayed.
Constant	The Constant attribute setting is displayed.
Network Publish	The Network Publish setting is displayed.
Edge	The differential type is displayed.
Comment	The comment is displayed.

Splitting the View

You can drag the split bar on the vertical scroll bar of the Ladder Editor to split the view vertically.

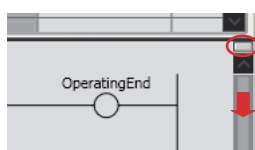

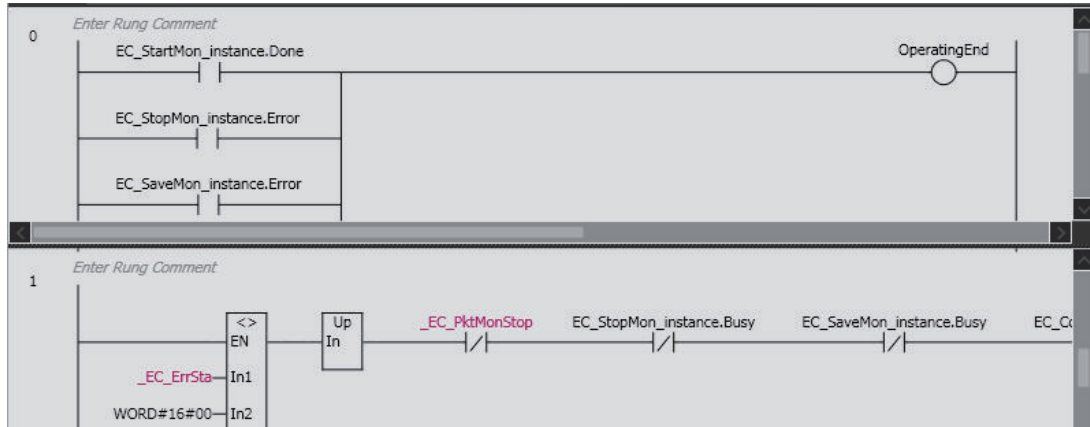

4-5-9 Ladder Editor Guide

Sysmac Studio displays the operation guide on the Ladder Editor for editing programs. You can arrange circuit parts, re-connect lines, and add lines following the guide.

To use this function, you need to select the **Show Ladder Editor Guide** Check Box in the option settings. Refer to 8-26 *Sysmac Studio Option Settings* on page 8-166 for details on the option settings.

Showing and Hiding the Ladder Editor Guide

Use one of the following methods to show and hide the Ladder Editor Guide.

Method 1: Select any circuit part and press the Ctrl + G Keys.

Method 2: Right-click a rung and select **Show Guide** from the menu.

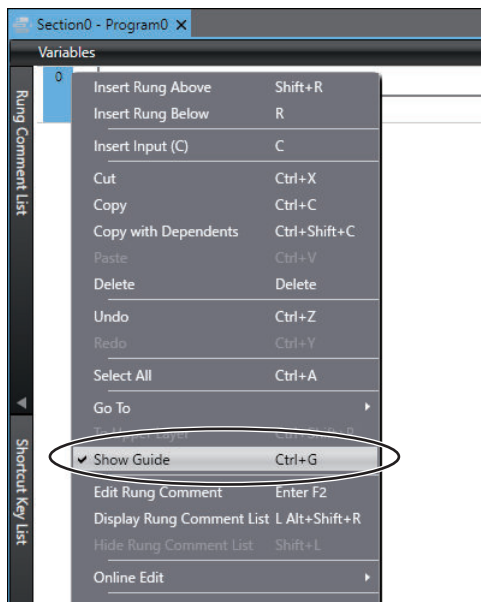

Parts Selection Guide

You can display the parts selection guide that helps to select circuit parts to add in the Ladder Editor. To add a circuit part, press the shortcut keys corresponding to the parts indicated in the guide.

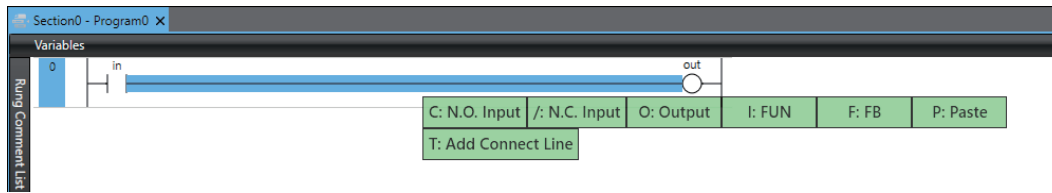

The parts selection guide appears when you perform one of the following operations.

- Select a horizontal connecting line in a rung.
- Select an insertion position indicated by the parts insertion guide.
- Select an addition position indicated by the connecting line addition guide.

Parts Insertion Guide

You can display the parts insertion guide that shows a part insertion position above or below any circuit part. Entering a number indicated in the guide displays the parts selection guide corresponding to the insertion position.

● Operation Example

- Inserting an OR rung for an N.C. input below an N.O. input

- 1 Select an input.
The parts insertion guide appears.

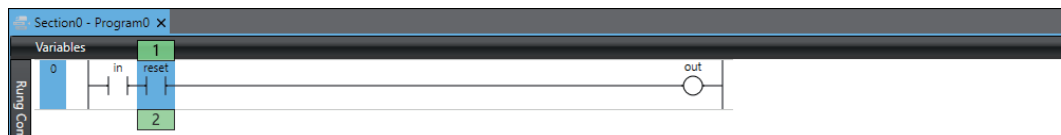

- 2 Press the 2 Key.

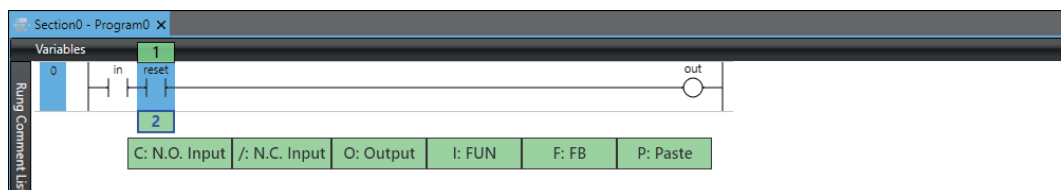

- 3 Press the / Key.
The circuit part selected in step 2 is inserted below the input selected in step 1.

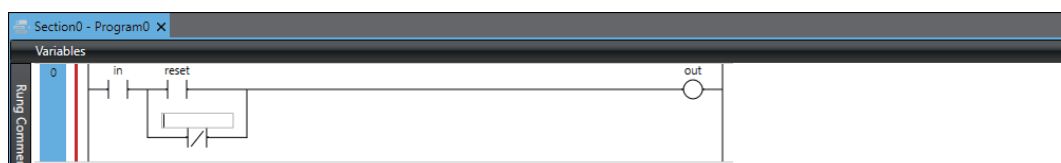

The parts insertion guide appears when you perform the following operation.

- Select an input, output, function, or function block in a rung.

Connecting Line Movement Guide

You can display the connecting line movement guide that helps to move vertical connecting lines in a rung to any position. Entering a number indicated in the guide moves the vertical connecting line to the specified position.

● Operation Example

- Moving the connection position of a vertical connecting line in an OR rung

- 1 Select a vertical connecting line.
The connecting line movement guide appears.

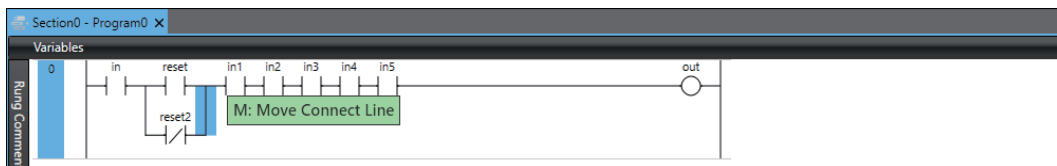

- 2 Press the M Key.
Numbers appear in positions to which the vertical connecting line can be moved.

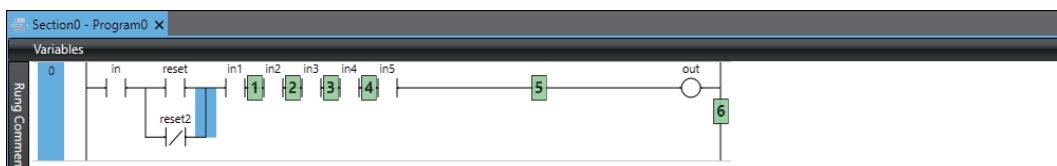

- 3 Press the 3 Key.
The vertical connecting line moves to the position selected in step 2.

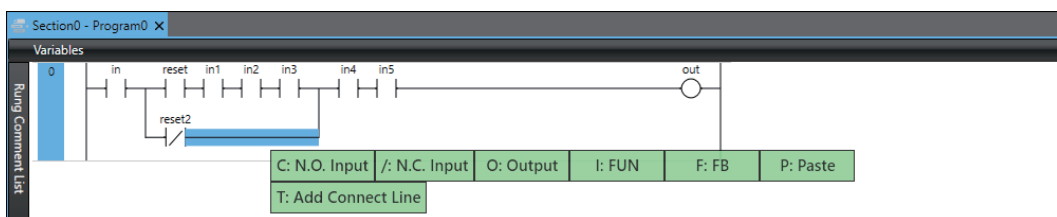

The connecting line movement guide appears when you perform the following operation.

- Select a vertical connecting line in a rung.

Connecting Line Addition Guide

You can display the connecting line addition guide that indicates a position you add a connecting line or part in a rung. Entering a number indicated in the guide displays the parts selection guide corresponding to the addition position of a connecting line.

● Operation Example

- Adding a vertical connecting line to an OR rung to insert an N.O. input inserted

- 1 Select a horizontal connecting line.
The connecting line addition guide appears.

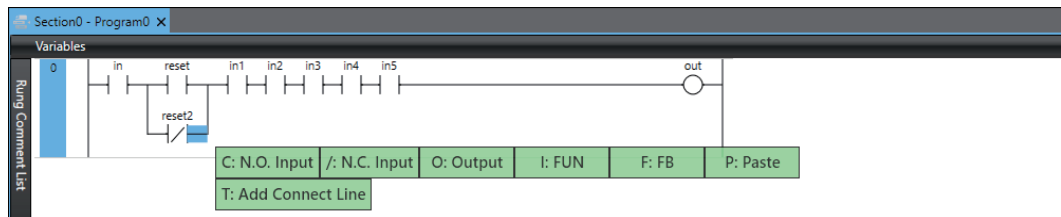

- 2 Press the T Key.
Numbers appear in positions to which a vertical connecting line can be added.

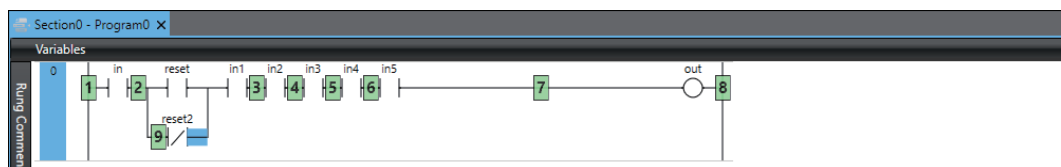

- 3 Press the 5 Key.
The parts insertion guide appears.

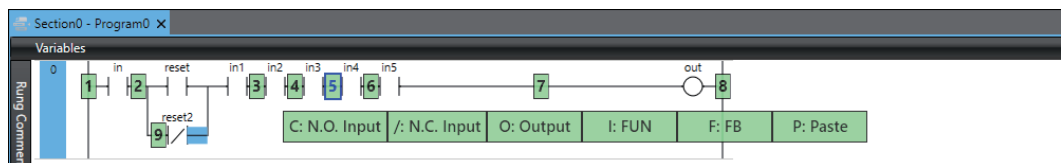

- 4 Press the C Key.
A vertical connecting line is added in the position selected in step 3 with the circuit part selected in step 4 connected.

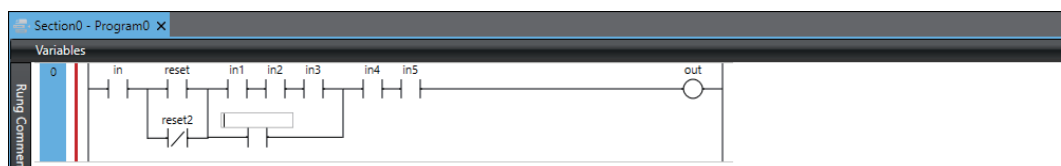

The connecting line addition guide appears when you perform the following operation.

- Select a horizontal connecting line in a rung.

4-5-10 Ladder Editor Shortcut Key List

You can display the shortcut key list for editing ladder programs.

Use one of the following methods to show and hide the shortcut key list.

Method 1: Press the H Key in the Ladder Editor.

Method 2: Click the **Shortcut Key List** Button in the Ladder Editor.

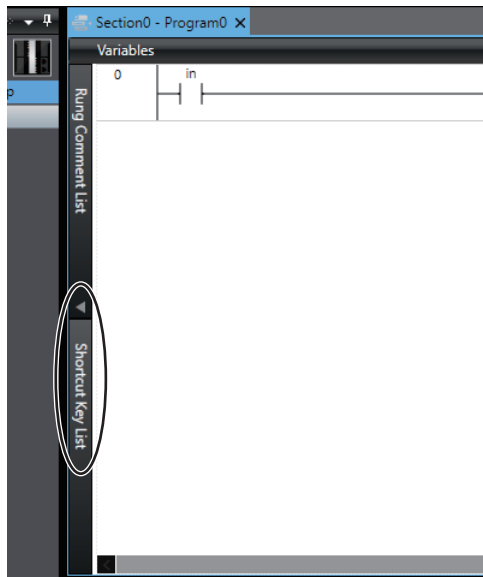

The following **Shortcut Key List** is displayed.

Function	Shortcut Key
Show/Hide Ladder Editor Guide	[Ctrl] + [G]
Insert N.O. Input	[C]
Insert N.C. Input	[I]
Insert Output	[O]
Insert Function	[F]
Insert Function Block	[F]
Insert Inline ST	[S]
Insert Above	[Ctrl] + [Shift] + [1]
Insert Below	[Ctrl] + [Shift] + [2]
Insert Rung Above	[Shift] + [R]
Insert Rung Below	[R]
Insert N.O. Input Above	[Shift] + [W]
Insert N.O. Input Below	[W]
Insert N.C. Input Above	[Shift] + [X]
Insert N.C. Input Below	[X]
Diff Up	[Ctrl] + [Shift] + [U]
Diff Down	[Ctrl] + [Shift] + [D]
Edit Variable Comment	[Ctrl] + [Enter]
Edit Element Comment	[Alt] + [Enter]
Rung Pattern Copy	[Ctrl] + [Shift] + [V]

4-5-11 Rung Pattern Copy

Rung pattern copy is a function that allows you to easily copy a rung pattern (logic part). Variable names in a copied rung can be set automatically according to the variable name generation rules.

Operating Procedure

Use the following procedure to perform a rung pattern copy operation.

- 1 Select copy source rungs in a ladder program.

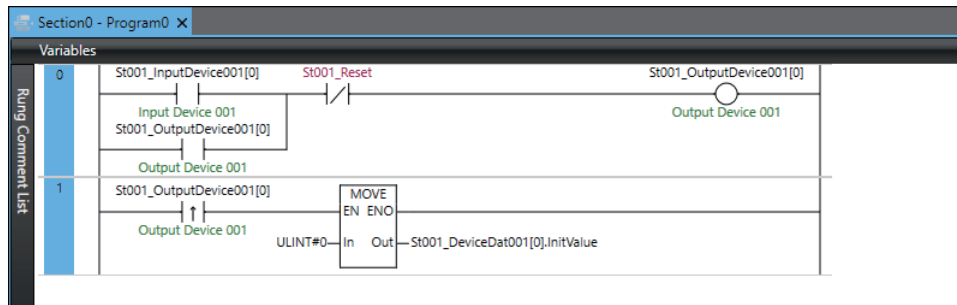

- 2 Right-click and select **Copy Rung Pattern** from the menu. Or, press the Ctrl + Shift + V Keys. The following setting dialog box is displayed.

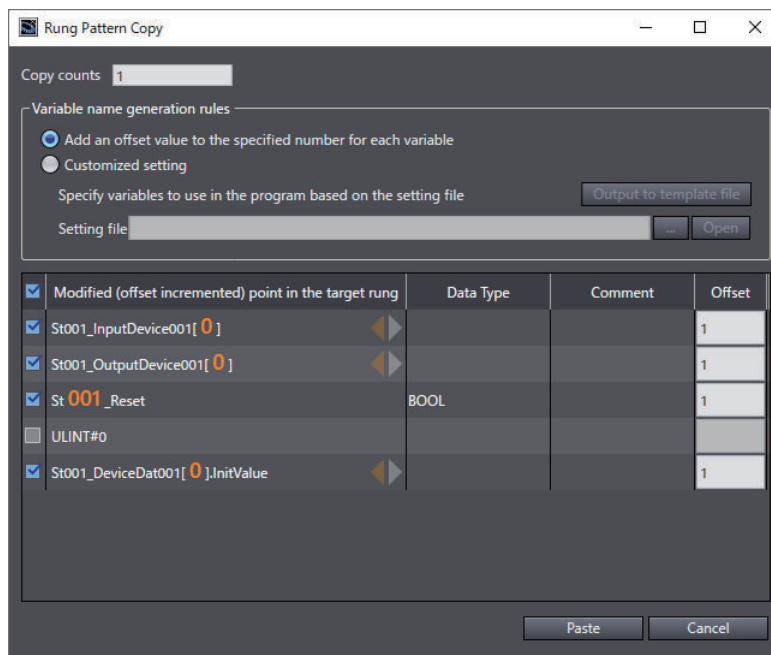

- 3 Configure the copy counts, variable name generation rules, variables to rename, and offset values.

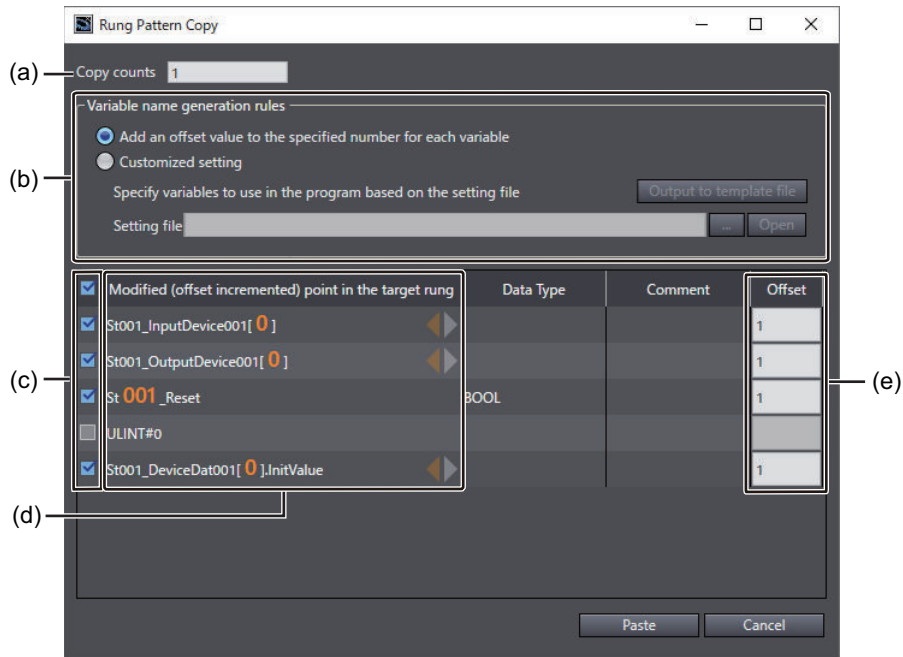

The setting items are listed in the following table.

No.	Item	Description
(a)	Copy counts	Determine the number of copies.
(b)	Variable name generation rules	Add an offset value to the specified number for each variable
	Customized setting	Select this option to generate any variable names and variable comments by reading the setting file. Refer to <i>File Format for Customized Setting</i> on page 4-150 described later for details.
(c)	Rename check boxes	Select the variables to rename. For variables whose check boxes are cleared, the same variable names as those in the copy source rungs will be used. Variables that do not contain a number in the variable name are automatically excluded from the rename target. The settings are also disabled when <i>Customized setting</i> is selected in Variable name generation rules .
(d)	Modified (offset incremented) point in the target rung	When Add an offset value to the specified number for each variable is selected in Variable name generation rules , the number for each variable name is shown in orange. Click the orange arrow shown at the right end and specify the number to which you want to add an offset value.
(e)	Offset	Set offset values for variable names, which will be added according to the variable name generation rules. Variables that do not contain a number in the variable name are automatically excluded from the rename target. The settings are also disabled when <i>Customized setting</i> is selected in Variable name generation rules .

4 Click the **Paste** Button.

If any variables are to be added by this function, the following dialog box is displayed.

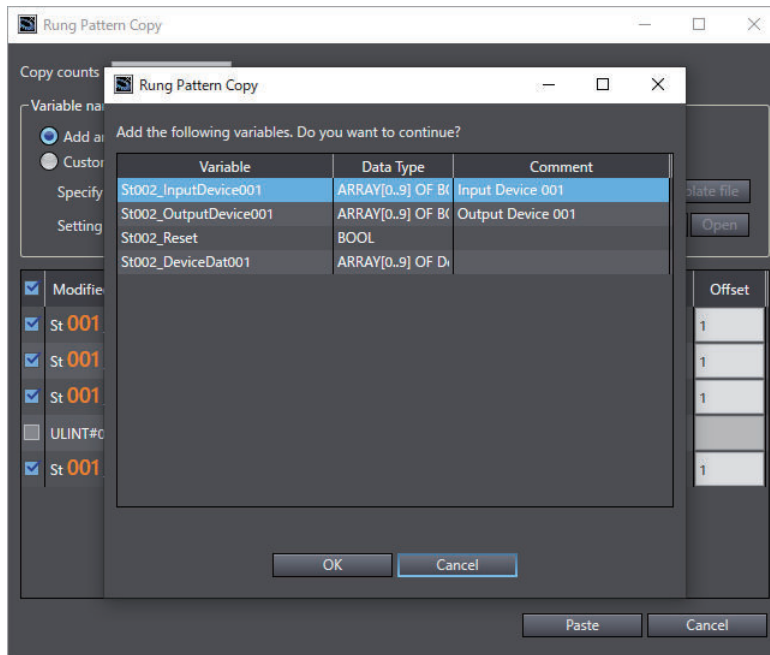

5 Click the **OK** Button.

If there are already variables with the same name but different attributes from the variables to be added by this function, the following dialog box is displayed.

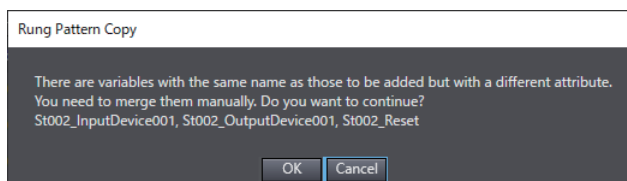

6 Click the **OK** Button.

The **Preparatory Variable Comparison** Dialog Box is displayed. If necessary, override the differences in variable attributes.

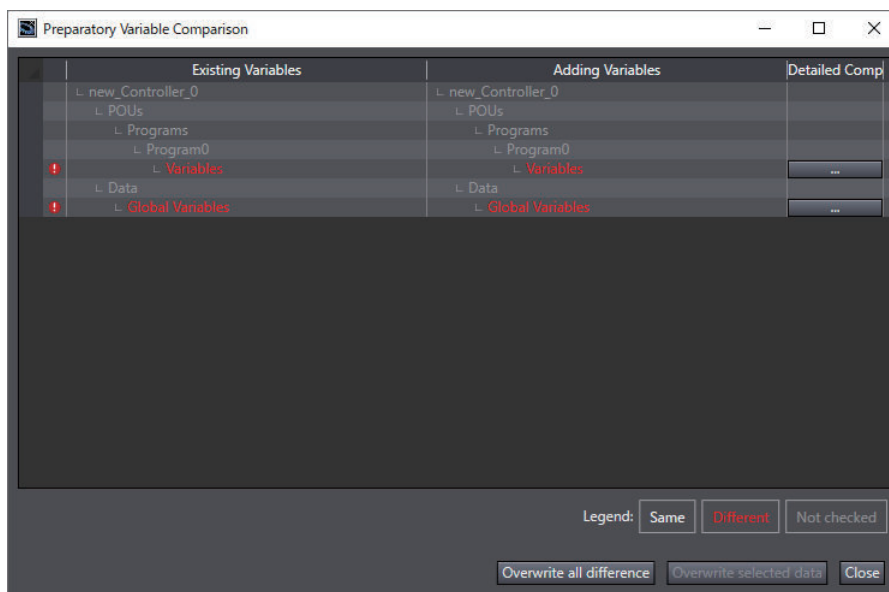

Rungs that use the specified variable names are generated.

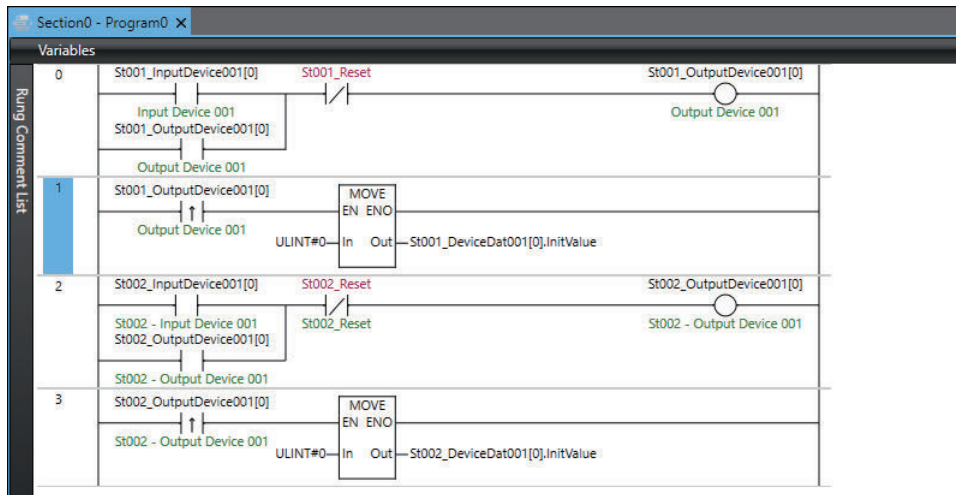

Precautions for Correct Use

- If the copy source rungs described with inline ST, you cannot perform a rung pattern copy operation.
- You cannot use the rung pattern copy function to create global variables during online editing. Clear the rename check boxes before you execute the function.

File Format for Customized Setting

Click the **Output to template file** Button to output a template of the customized setting file that you use in the rung pattern copy function. The file format of the customized setting is as follows. Edit variable names and variable comments as needed.

Sysmac Studio Ladder Program PaFileVersion:1.0		CopyCount:2			
[Original]	<Comment>	[Copy1]	<Comment>	[Copy2]	<Comment>
<Variable>		<Variable>		<Variable>	
//RungComment	Self-holding for input value	//RungComment	Self-holding for input value	//RungComment	Self-holding for input value
St001_InputDevice001[0]		St001_InputDevice001[0]		St001_InputDevice001[0]	
St001_OutputDevice001[0]		St001_OutputDevice001[0]		St001_OutputDevice001[0]	
St001_Reset		St001_Reset		St001_Reset	
//RungComment	Set initial value	//RungComment	Set initial value	//RungComment	Set initial value
ULINT#0		ULINT#0		ULINT#0	
St001_DeviceDat001[0].InitValue		St001_DeviceDat001[0].InitValue		St001_DeviceDat001[0].InitValue	
(a)	(b)	(c)	(d)	(e)	(f)

	Item	Description	Remarks
(a)	Source variable names	Variable names used in source rungs.	Do not edit this item.
(b)	Source variable comments	Comments on the variables used in source rungs.	Do not edit this item.
(c)	Copy 1 variable names	Variable names used for the first destination. Any variable names can be set.	
(d)	Copy 1 variable comments	Variable comments used for the first destination. Any variable comments can be set.	
(e)	Copy 2 variable names	Variable names used for the second destination. Any variable names can be set.	
(f)	Copy 2 variable comments	Variable comments used for the second destination. Any variable comments can be set.	

After this, the **Variable** and **Comment** columns will be repeated.



Precautions for Correct Use

- If you edit the CSV file used for the customized setting using spreadsheet software, etc., save it in CSV UTF-8 format.
 - You can set any rung comments only when *Customized setting* is selected in **Variable name generation rules**. The identifier *//RungComment* is set in the variable name column of the setting file output by the template. Set any rung comments in the variable comment fields.
-

4-6 Programming Structured Text

You can use either ladder diagrams (LD) or Structured Text (ST) to code the algorithms used in POU's (programs, functions, and function blocks).

This section describes how to program in ST.

- Programming Structured Text

ST (structured text) programming involves using the ST language to build algorithms. To do this, you enter data processing in the ST Editor.

- Editing ST

You combine different ST statements to build algorithms.

For information on statement structures and expressions, refer to information on the structured text language in the *NJ/NX-series CPU Unit Software User's Manual (Cat. No. W501)* or *NY-series Industrial Panel PC / Industrial Box PC Software User's Manual (Cat. No. W558)*.

4-6-1 Starting the ST Editor

Programs

Double-click an ST program under **Programming - POU's - Programs** in the Multiview Explorer. Or, right-click the ST program and select **Edit** from the menu.

Refer to *4-2 Registering POU's* on page 4-57 for the procedure to register a program.

The ST Editor for the program is displayed.

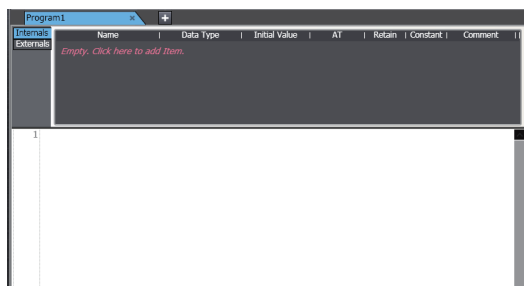

Functions and Function Blocks

- 1 Double-click an ST function block (or ST function) under **Programming - POU's - Function Blocks (or Functions)** in the Multiview Explorer. Or, right-click the ST function or function block and select **Edit** from the menu.

For information on registering ST functions or function blocks, refer to *4-2-3 Registering Function Blocks* on page 4-60 or *4-2-4 Registering Functions* on page 4-62.

The ST Editor for the function or function block is displayed.

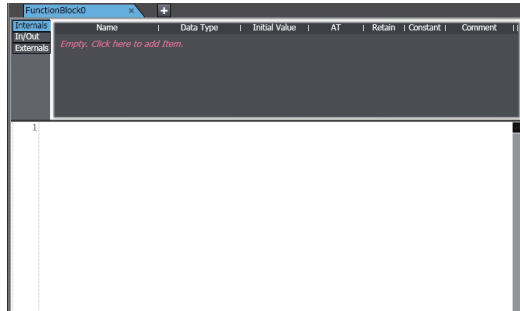

4-6-2 Basic ST Editor Operations

Entering Assignment Statements

The following example shows how to assign the sum of variables *aaa* and *bbb* into variable *ccc*.
`ccc := aaa + bbb ;`

The *aaa*, *bbb*, and *ccc* variables are registered in the variable table in advance.

You can also register new variables in a variable table when you enter unregistered variable names on the ST Editor. Refer to *Registering Variables on the ST Editor* on page 4-158 for details.

- 1 Enter the first letter of the variable *ccc* into the ST Editor.
A list of possible variable candidates is displayed in a list.

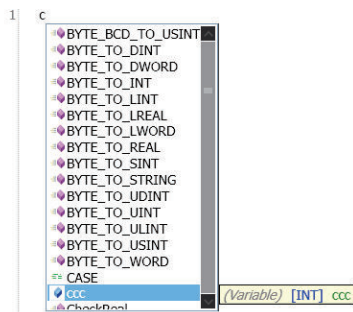

- 2 Select the variable *ccc* and press the Enter Key.
The variable *ccc* is entered.

```
1  ccc|
```

- 3 Enter a space and a : (colon) character.
The assignment keyword := is entered automatically.

```
1  ccc :=
```

- 4 Enter the first letter of the variable *aaa*.

- 5** Select the variable *aaa* from the list of variable candidates and press the Enter Key.
The variable *aaa* is entered.

```
1 | ccc:=aaa|
```

- 6** Enter a space and a + (plus) character and then enter the first letter of the variable *bbb*.

- 7** Select the variable *bbb* from the list of variable candidates, enter a semi-colon (;), and press the Enter Key.

This completes the assignment statement.

```
1 | ccc:=aaa + bbb;
```



Additional Information

You can use an option setting to prevent the automatic display of the candidate list when entering text in the ST Editor. Refer to *8-26 Sysmac Studio Option Settings* on page 8-166 for the setting procedure. Even if you prevent the automatic display, you can display the candidate list by pressing the Ctrl + Space Keys.

Entering Control Statements

The following example shows how to enter an IF construct.

```
IF aaa = bbb THEN
  ccc := aaa;
END_IF
```

- 1** Enter the first letter of the *IF* statement (*i*) into the ST Editor.
A list of possible candidates is displayed in a list.

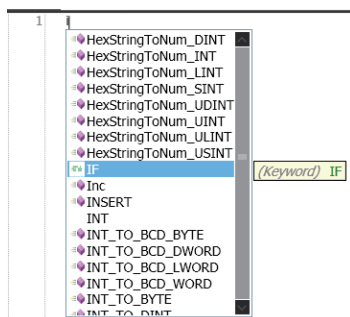

- 2** Select the *IF* keyword and press the **Enter** Key.
The *IF* keyword is entered.

```
1 IF
```

3 Press the **Tab** Key.

The other keywords that make up an IF construct are entered automatically.

```
1 IF expression THEN
2   statement_group
3 ELSIF expression THEN
4   statement_group
5 ELSE
6   statement_group
7 END_IF;
```

4 Enter the statement *aaa = bbb*.

```
1 IF aaa = bbb THEN
2   statement_group
3 ELSIF expression THEN
4   statement_group
5 ELSE
6   statement_group
7 END_IF;
```

5 Delete *ELSIF*, *THEN*, and *ELSE* and then enter *ccc := aaa ;*. This completes the IF construct.

```
1 IF aaa = bbb THEN
2   ccc:=aaa;
3
4 END_IF;
```



Additional Information

- Press the **Tab** Key after entering the first keyword of a construct to automatically complete the rest of the construct.
- If there is a problem with the format of a construct, a red wavy line is displayed to the right of the statement keywords.
- You can also drag the control statements from the Structured Text Tools in the Toolbox to enter them.

Entering Constants

The following example shows how to assign the hexadecimal value *FFFF* to variable *aaa*.

- 1** Enter `aaa :=` into the ST Editor.
- 2** Enter the constant as `WORD#16#FFFF`.
For information on the formats for entering other constants, refer to the *NJ/NX-series CPU Unit Software User's Manual (Cat. No. W501)* or *NY-series Industrial Panel PC / Industrial Box PC Software User's Manual (Cat. No. W558)*.

```
1 | aaa:=WORD#16#FFFF;|
```

Entering Comments

Enter (* at the beginning and *) the end of any text to be treated as a comment in the ST Editor. If you only want to comment out a single line, enter a double forward slash (//) at the beginning of the line.

```
1 | aaa:=WORD#16#FFFF;
2 | IF aaa = bbb THEN (*if aaa = bbb, ccc = true*)
3 |   ccc := TRUE;
4 | END_IF;
5 | //End of program1.
```

Deleting ST Elements

- 1** Select the text to delete.
- 2** Press the Delete Key or the Backspace Key to delete the text.

Copying and Pasting ST Elements

There are the following ways to copy ST elements.

- **Copy:** Only selected text strings are copied.
- **Copy with Dependents:** Not only the selected text string but also variables that are referenced in the text string and the data types of the variables are copied.

- 1** Select the text to copy.
- 2** Right-click the text and select **Copy** from the menu. Or, select the text and press the Ctrl + C Keys. If you want to copy data together with referenced variables and their data types, select **Copy with Dependents**.
- 3** Right-click at the location where you want to paste and select **Paste** from the menu. Or, press the Ctrl + V Keys.
The copied text string is pasted.
If you select **Copy with Dependents** and paste the text string into another ST program, not only the text string but also variables that are referenced in the text string and the data types of the variables are also added to the destination ST program.

If a variable or data type with the same name and different attribute already exists in the destination program, the **Comparison before pasting dependents** Dialog Box is displayed. For details on the **Comparison before pasting dependents** Dialog Box, refer to *4-7 Comparison before Pasting Dependents* on page 4-166.

Indenting

You can indent nested statements to make them easier to read.

- 1 Right-click at the beginning of the line to indent and select **Increase Line Indent** from the menu. Or, press the Tab Key.
The indent moves the starting position of the characters on that line to the right.
- 2 To bring the indent back, right-click the text and select **Decrease Line Indent** from the menu or press the Delete Key.

Moving to a Specified Line

You can specify a line number to jump directly to that line.

- 1 Right-click in the ST Editor and select **Go To** from the menu. A **Jump** Dialog Box is displayed.

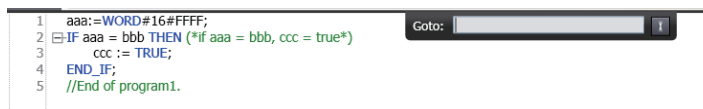

```

1  aaa:=WORD#16#FFFF;
2  IF aaa = bbb THEN (*if aaa = bbb, ccc = true*)
3      ccc := TRUE;
4  END_IF;
5  //End of program1.

```

The screenshot shows a code editor window with a 'Goto:' dialog box open at the top right. The code in the editor is as follows:

- 2 Enter a line number and press the Enter Key.
The cursor moves to the beginning of the line you entered.

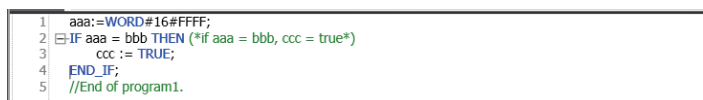

```

1  aaa:=WORD#16#FFFF;
2  IF aaa = bbb THEN (*if aaa = bbb, ccc = true*)
3      ccc := TRUE;
4  END_IF;
5  //End of program1.

```

The screenshot shows the same code editor window as above, but the cursor is now positioned at the beginning of line 2, indicating that the 'Go To' action was successful.

Bookmarks

You can add bookmarks to any lines and move between them.

Toggle Bookmarks

Right-click a line number in the ST Editor and select **Toggle Bookmark** from the menu. A bookmark is displayed at the beginning of the line.

Moving to the Next Bookmark

Right-click a line number in the ST Editor and select **Next Bookmark** from the menu. The cursor moves to the next bookmarked line.

Moving to the Previous Bookmark

Right-click a line number in the ST Editor and select **Previous Bookmark** from the menu.
The cursor moves to the previous bookmarked line.

Deleting a Specific Bookmark

Right-click a line number with the bookmark and select **Toggle Bookmark** from the menu.
The bookmark is deleted.

Deleting All Bookmarks

Right-click a bookmark and select **Clear Bookmarks** from the menu.
All bookmarks are deleted.

Statement Error Displays

When you enter a statement, the format is always checked and any mistakes are displayed as errors.
A wavy line is displayed under any line where an error is detected.

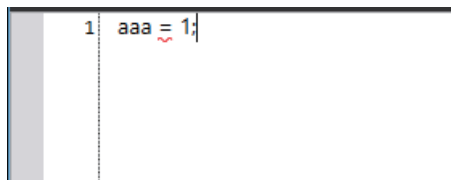

Error: Red wavy line

Warning: Blue wavy line

Place the mouse over the wavy line to view information on the error.

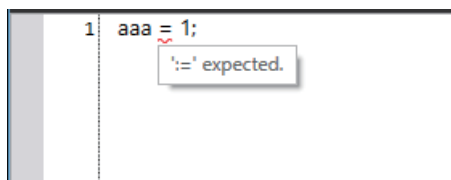

Refer to *11-2 Error Messages for Structured Text Checks* on page 11-7 for information on errors.

4-6-3 Editing Variables and Data Types in the ST Editor

Registering Variables on the ST Editor

You can register new variables in a variable table when you enter unregistered variable names on the ST Editor.

- Adding title
Adding variables using variable registration mark

1 Enter an unregistered variable name.

Internals	Name	Data Type
Externals	aaa	WORD

```

1 aaa := WORD#16#FFFF;
2 IF aaa = bbb

```

A variable registration mark is displayed under the variable name.

```

1 aaa := WORD#16#FFFF;
2 IF aaa = bbb

```

- 2 Click the variable registration mark.
A dialog box is displayed for you to enter the data type.

- 3 Enter a data type and press the Enter Key.
The new variable is registered in the local variable table.



Additional Information

You can select the **Select local or global variable and register it** Check Box in the option settings to specify the variable table in which the variable names are registered. Refer to 8-26 *Sysmac Studio Option Settings* on page 8-166 for details.

Adding Variables Using Pop-up Menu

- 1 Enter an unregistered variable name.
- 2 Right-click an entered variable name and select **Register in Variable Table** from the menu.

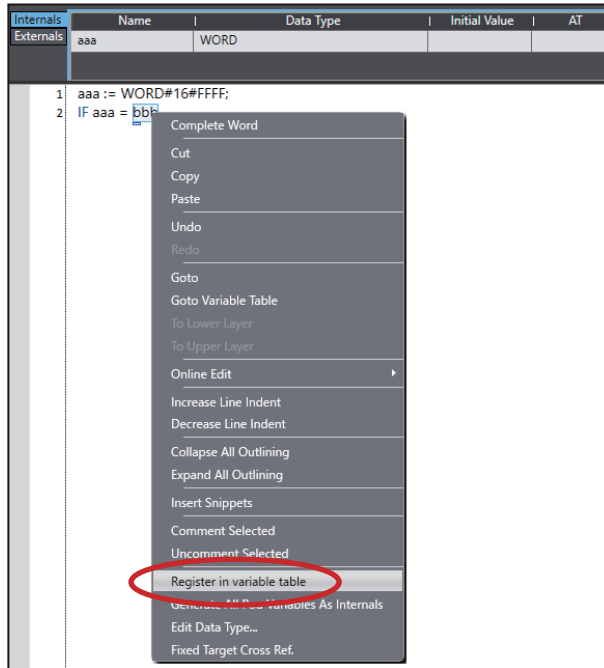

The **Select the variable type** Dialog Box is displayed.

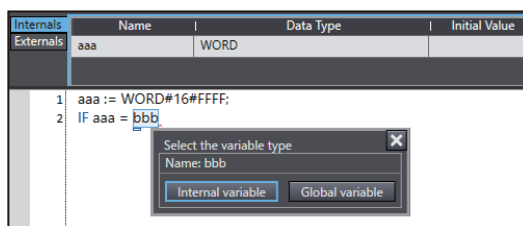

- 3** Select a variable type you want to register on the **Select the variable type** Dialog Box.
- 4** Then, the **Enter the data type** Dialog Box is displayed. Enter a data type and press the Enter Key.
This completes the registration of a new variable in a local or global variable table.



Additional Information

You can right-click in the ST Editor and select **Generate All Pou Variables As Internals** from the pop-up menu to register all of the unregistered variables in the ST Editor as internal variables at a time. The variable is registered in the variable table and the data type is left blank. Even if you select the **Specify the data type** Check Box in the option settings, a text box to enter the data type is not displayed.

Jumping to a Variable Table

You can display the variable table where a selected variable is registered and jump to the line for that variable.

Right-click a variable and select **Go To Variable Table** from the pop-up menu. Or, select the variable and press the Ctrl + Alt + J Keys.

Displaying Variable Comments

Variable comments are displayed in tooltips when you move the mouse over variables in the ST Editor. The display rules for comments are the same as those for the Ladder Editor. Refer to *Displaying and Editing Variable Comments* on page 4-114 for the comment display rules.



Precautions for Correct Use

- For information on ST input restrictions (restrictions on the number of operators, the number of nested POU calls, and the number of nested conditional/iterative statements), refer to the *NJ/NX-series CPU Unit Software User's Manual (Cat. No. W501)* or *NY-series Industrial Panel PC / Industrial Box PC Software User's Manual (Cat. No. W558)*.
- A single POU (program, function, or function block) can contain up to 10,000 lines of code.
- When you use a function block in the ST Editor, register the function block instance in the variable table in advance. You cannot register a function block instance in the ST Editor.
- After you paste an ST element, check to be sure that the variables and their data types are used correctly.

Editing Data Types

If you perform editing offline, you can change the data types of variables on the ST Editor.

- 1 Right-click a variable and select **Edit Data Type** from the pop-up menu. A dialog box is displayed for you to enter the data type.

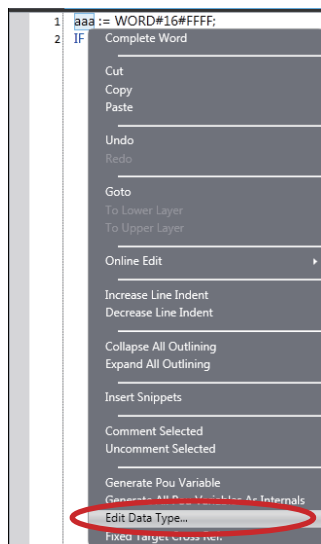

- 2 Enter the new data type and press the Enter Key. The data type of the variable is changed.

4-6-4 Operating Functions and Function Blocks in the ST Editor

Entering the Function Name or Instance Name of the Function Block Directly into the ST Editor

Enter the function name or instance name of the function block directly into the ST Editor.

- 1 Enter the first letter of the instance name of the function or the function block into the ST Editor.
- 2 Select the function name or the function block instance name from the list and press the Enter Key.

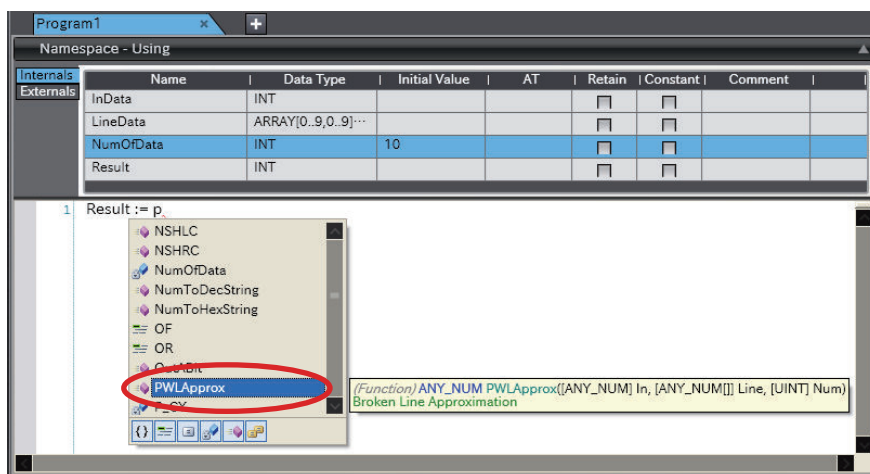

The selected function or function block instance is displayed. When you enter a *left parenthesis*, a description of the parameters is displayed.

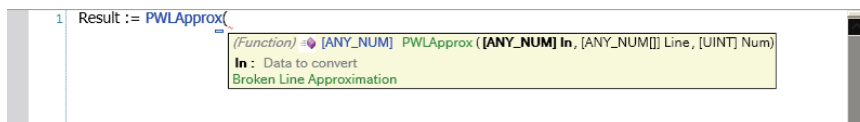

- 3 Either click a parameter marker that is displayed for the function or function block instance that you entered, or press the Tab Key while the mark is still displayed.



A parameter is added.

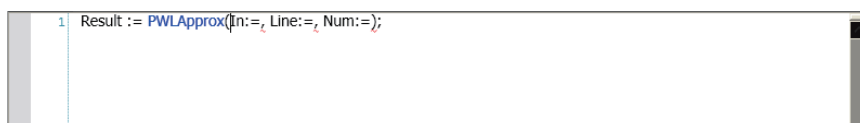

- 4 Enter the required parameters and complete the statement.

```
1 Result := PWLApprox(In:=InData, Line:=LineData[2,4], Num:=NumOfData);
```

Dragging a Function or Function Block from the Toolbox

Drag a function or function block from the Toolbox.

- 1 Drag the required function or function block from the Toolbox to the insertion location on the ST Editor.

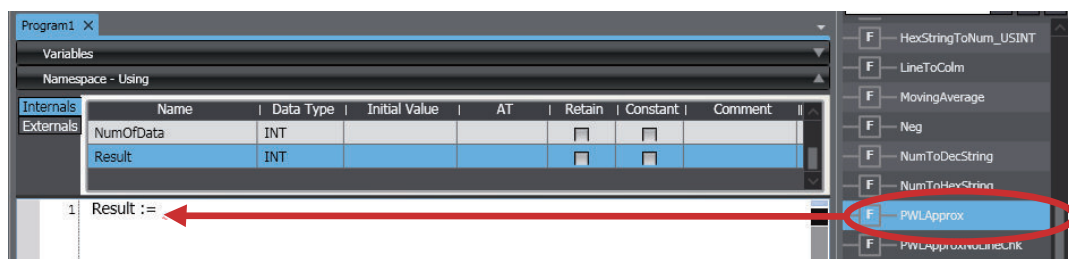

The function or function block is inserted with temporary variables.

Function Example

```
1 Result := PWLApprox(In:=var0, Line:=var1, Num:=var2);
```

Function Block Example

```
1 Result := TON(In:=var0, PT:=var1, Q=>var2, ET=>var3);
```

- 2 Click the variable registration mark and register new variables for the temporary variables or replace the temporary variables with registered variables to complete the statement.

```
1 Result := PWLApprox(In:=InData, Line:=LineData(2,4), Num:=NumOfData);
```

Displaying the Contents of User-defined Functions and Function Blocks

You can display the contents of a user-defined function or function block from an ST program.

- 1 Right-click the user-defined function or function block name in the ST program and select **To Lower Layer**.

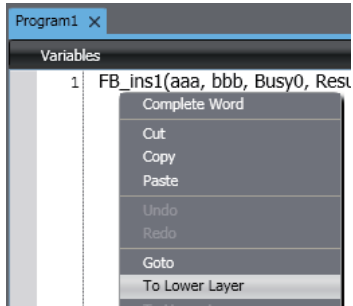

The contents of the function or the definition of the function block is displayed.

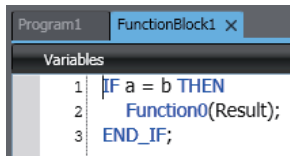

- 2 To return from the displayed function or function block definition to the original ST program, right-click on the function or function block definition and select **To Upper Layer**.

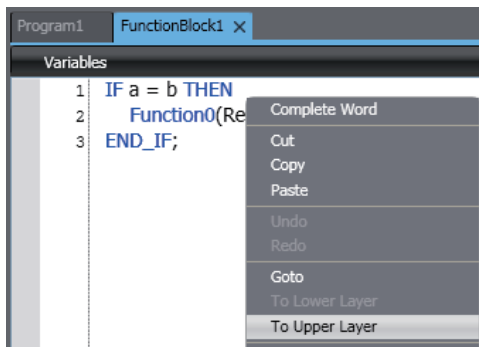

The original ST program is displayed.



Additional Information

- You cannot use the **To Lower Layer** menu command to display the contents of a function or the definition of a function block in the following cases.
 - a) The function or function block is defined in a library that is set so that you cannot display the source.
 - b) The maximum number of tabs are already displayed in the Edit Pane.
- You can select the **To Upper Layer** menu command only from a function or function block definition that you displayed with the **To Lower Layer** menu command. The **To Upper Layer** menu command is valid only while the tab page for the contents of the function or the definition of the function block is displayed. However, in the following cases, the contents of the original program is not displayed even if you select the **To Upper Layer** menu command.
 - a) The original program is defined in a library that is set so that you cannot display the source.
 - b) The maximum number of tabs are already displayed in the Edit Pane.
- If you display the same function block definition from more than one program and then select the **To Upper Layer** menu command from the function block definition, the program where you last selected the **To Lower Layer** menu command is displayed.
- If you select the **To Lower Layer** menu command while online, the contents of the function block instance are displayed instead of the function block definition. If you then display the same function block definition from a different instance, the display is overwritten. In that case, you can select the **To Upper Layer** menu command only from the function block instance where you last selected the **To Lower Layer** menu command.

4-6-5 Customizing the View

Splitting the View

You can drag the split bar on the vertical scroll bar of the ST Editor to split the view vertically.

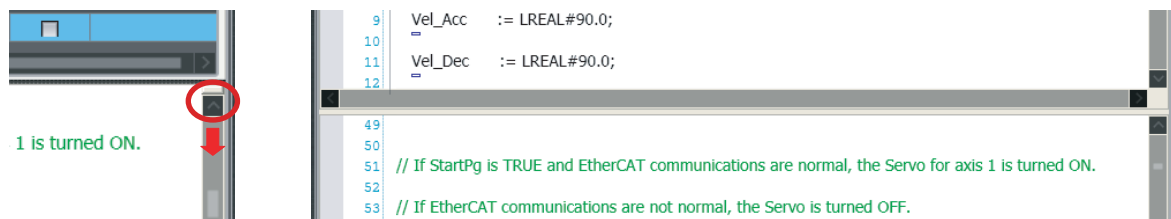

4-7 Comparison before Pasting Dependents

When you paste data that was copied by selecting **Copy with Dependents** from the pop-up menu in the Multiview Explorer, Ladder Editor or ST Editor, there may already be a variable or data type with the same name and different attribute in the paste destination. In such a case, the **Comparison before pasting dependents** Dialog Box is displayed to confirm whether you want to overwrite the data.

You can check the differences between data before overwriting.

4-7-1 Comparison before Pasting Dependents Dialog Box

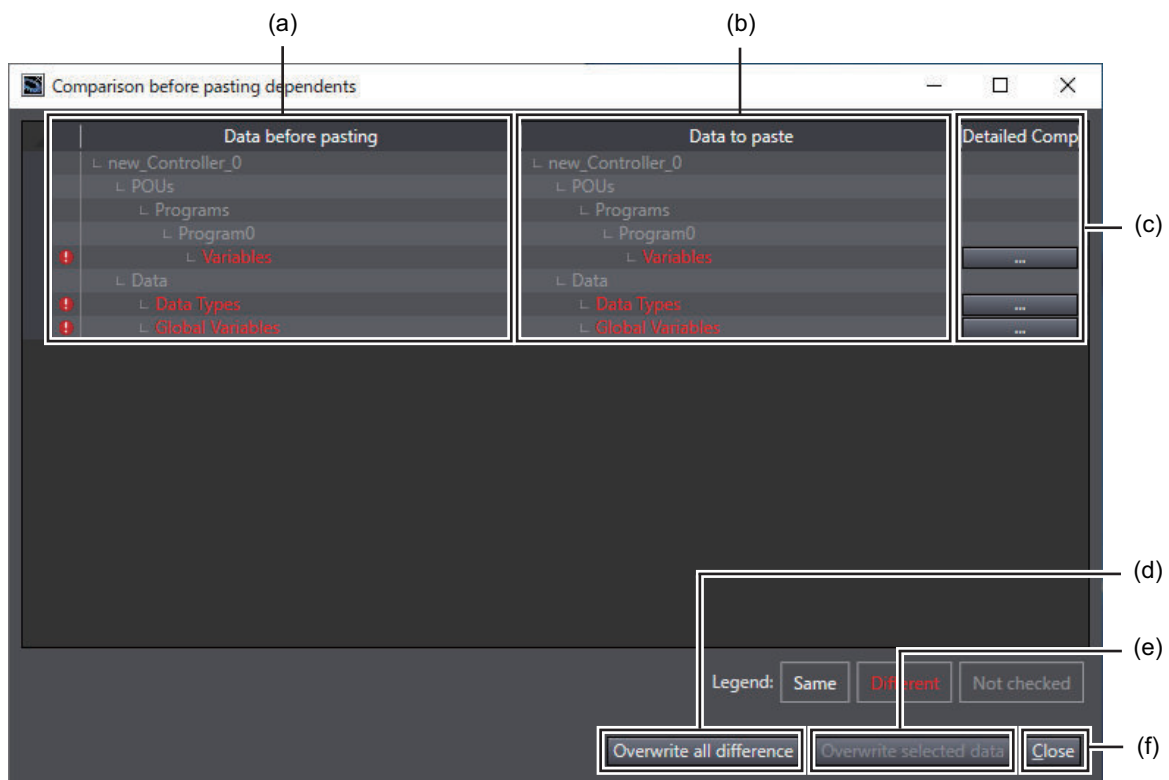

	Item	Description
(a)	Data before pasting	Displays existing data if any difference is detected. The lines which contain any data differences are displayed in red.
(b)	Data to paste	Displays data to be pasted if any difference is detected.
(c)	Detailed Comparison Button	Displays the Detailed Comparison Window that contains difference details.
(d)	Overwrite all difference Button	Overwrites all existing data that contain any differences with the data to be pasted.
(e)	Overwrite selected data Button	Overwrites the existing data in the selected line with the data to be pasted.
(f)	Close Button	The Dialog Box is closed.

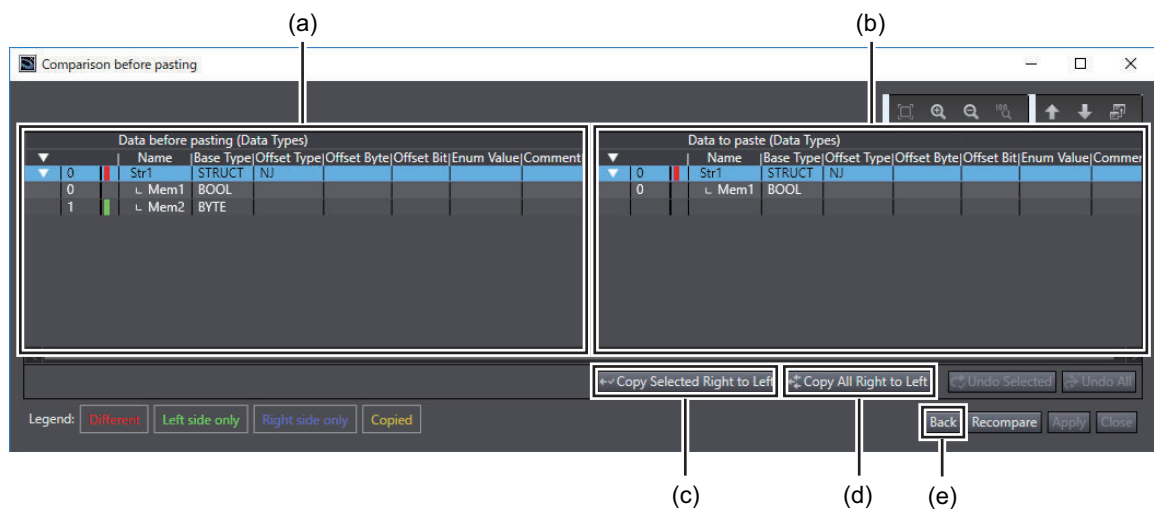

	Item	Description
(a)	Data before pasting	Displays data that already exists. The lines which contain any data differences are displayed in red.
(b)	Data to paste	Displays data that is to be pasted.
(c)	Copy Selected Right to Left Button	Overwrites the existing data in the selected line with the data to be pasted.
(d)	Copy All Right to Left Button	Overwrites all existing data that contain any differences with the data to be pasted.
(e)	Back Button	Returns to the Comparison before pasting dependents Dialog Box.

4-8 Searching and Replacing

● Searching and Replacing

You can search and replace strings in the data of the currently selected device.

WARNING

When you search and replace a string in a project that includes more than one device, check the device on which to perform the search and replace before you replace it. If you replace data of an unintended device, the controlled system may cause an unexpected operation.



4-8-1 Scope of Searching and Replacing

You can search and replace text strings in the following items.

Variable tables	Ladder diagrams	ST
Variable names	Rung comments	Text strings
Variable comments	Variable names	Variable names
	Function names	Function names
	Function block definition names	Function block instance names
	Function block instance names	
	Element comments	
	Variable comments	

4-8-2 Search and Replace Pane

Use the following procedure to display the Search and Replace Pane.

- 1 Select **Search and Replace** from the **Edit** Menu.

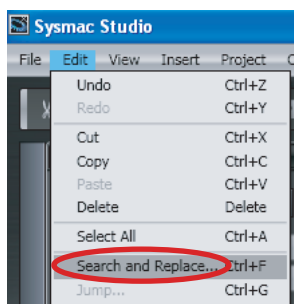

The Search and Replace Pane is displayed.

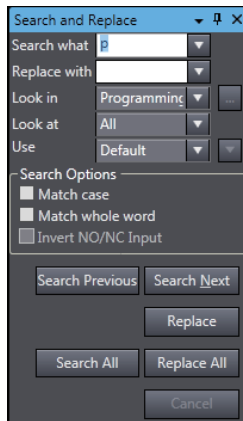

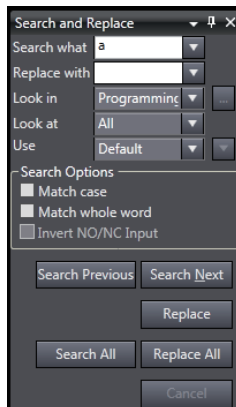

4-8-3 Items to Set

The settings in the Search and Replace Pane are explained below.



Setting	Description
Search what	<ul style="list-style-type: none"> Enter a search string. You can select from previous search strings in the list. If you select All or Variable name in the Look at Box, and enter the letters that are included in the variable name or press the Ctrl + Space Keys, variable names are displayed as candidates in the list.
Replace with	<ul style="list-style-type: none"> Enter the string to replace the search string with. You can select from previous replacement strings in the list. <p>You cannot use wildcard characters. (If you try to use them, they are treated as normal text strings.)</p>
Look in	<p>Specify the range to search. You can select from the following.</p> <p>Programming: All of the programming of the Controller is searched.</p> <p>Checked elements: The item that is selected in the Select search and replace scope Dialog Box is searched.</p> <p>Current View: The current view is searched.</p> <p>Selection: The range that is selected, which is a range of circuits of a ladder program, a range of text lines of an ST program, or the like, is searched.</p>
Look at	<p>Specify the items to search. You can search for text strings in the following items.</p> <p>All: Searches all text strings (excluding variable comments on ladder)</p> <p>Variable name: Searches all variable names.</p> <p>Instructions: Searches instructions (including program inputs and outputs)*¹</p> <p>Variable comment on ladder: Searches variable comments on ladder.*²</p>

Setting	Description
Use	<p>Specify if you want to use wildcard characters. Default: Do not use wildcard characters. Wildcard: Use wildcard characters.</p> <p>If you select to use wildcard characters, you can click the  Button to the right to view a list of characters used for wildcard characters. Select any of these characters to enter them in the search string.</p> 

*1. This can be used only for searches.

*2. This can be used only for searches only when **Ladder Editor - Variable Comment - Show comment** Check Box is selected in the option settings. Refer to *8-26 Sysmac Studio Option Settings* on page 8-166 for details on the option settings.



Precautions for Correct Use

- If more than one device is registered in the project, the target of a search and replace is the currently selected device only. Be sure to check the selected device in the device list for the project before you perform a search and replace.
- If you set the Look in Box to the variable table, set the Look at Box to the variable name, and perform a replacement, only the variable names in the variable table will be changed.

● Selecting a Search and Replace Scope

If you selected **Checked elements** in the Look in Box, select the range in the **Select search and replace scope** Dialog Box. The **Select search and replace scope** Dialog Box is displayed when you click the **Select search and replace scope** Button on the right of the drop-down arrow of the Look in Box.

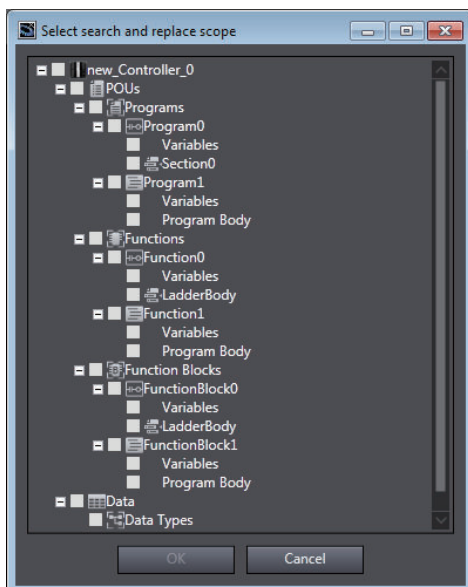

Select the check boxes for the items to search, and then click the **OK** Button.

● Narrowing Down the Search

You can narrow down the searched items even more if you specify a combination of the instruction name and variable name for the search string.

Enter a single-byte space between the instruction name and variable name.

To search for	Search string specification*1
Program input of a specified variable*2	LD variable_name
Program output of a specified variable*2	OUT variable_name
Function that uses the specified variable as a parameter	Function_name variable_name
Function block definition that uses the specified variable as a parameter*2	Function_block_definition_name variable_name
Function block instance that uses the specified variable as a parameter	Function_block_instance_name variable_name

*1. You can specify a constant value instead of a variable name.

*2. Only ladder rungs are searched.

● Wildcards

You can use the following wildcard characters.

Meaning	Syntax	Description	Example
Any single character	?	Searches for a text string with a variable character.	"A?C" matches "ABC", "AdC", and "AzC".
Any one character or series of characters	*	Searches for a text string that contains a variable text string	"new*" matches "newfile.txt".
Any single number	#	Searches for any single number.	"7#" matches "71". "ABC#" matches "ABC5".
Character in a set	[]	Searches for a single character in the set.	"ABC[xyz]" matches both "ABCx" and "ABCy". "ABC[x-z]" matches both "ABCx" and "ABCy".
Character not in a set	[!]	Searches for a single character that is not in the set.	"ABC[!xyz]" matches both "ABCa" and "ABCd". "ABC[!x-z]" matches both "ABCa" and "ABCd".

● Search Options

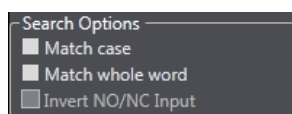

Item	Description
Match case	When this option is selected, searches are case sensitive.
Match whole word	When selected, only exact string matches are returned.
Invert NO/NC input	Replaces N.O. with N.C. and N.C. with N.O. for all BOOL variables used in a ladder diagram. (Output bits are not affected.)

● Button Functions

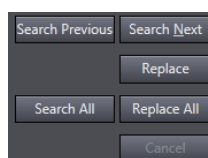

Item	Description
Search Next	Performs a search according to the selected options.
Search Previous	Performs a search in the reverse order of Search Next .
Search All	Searches all items and displays the results in the Search and Replace Results Tab Page.
Replace	Performs a replace according to the selected options.
Replace All	Replaces all items and displays the results in the Search and Replace Results Tab Page.
Cancel	Cancels the current search and replace operation.

4-8-4 Searching

The procedures for searching are given in this section.

As an example, the following describes a search for a variable name.

- 1 Enter the search string in the **Search what** Field.

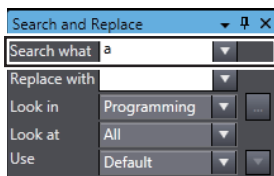

- 2 Select *Variable name* in the **Look at** Field to search for variables.

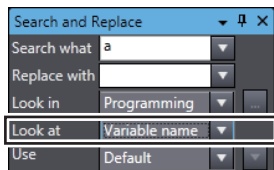

- 3 Set the **Look in** Field and search options as required.*

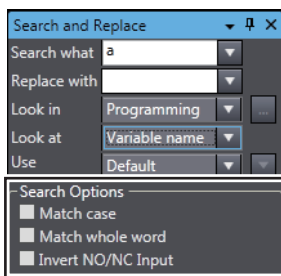

- 4 Click the **Search Next** Button.

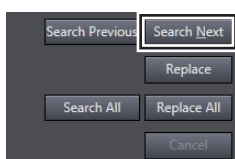

The searched items are highlighted.

The search starts again from the beginning when the target data is searched to the end.

To display all of the search results at the same time, click the **Search All** Button. Then, all searched items in the search range are highlighted and the search results are displayed in the Search and Replace Results Tab Page.

```

Search and Replace Results
Searching 'p'
1 : new_Controller_0:POUs/Programs/Program0/Section0(0): Input PB1
2 : new_Controller_0:POUs/Programs/Program0/Section0(0): Input PB2
3 : new_Controller_0:POUs/Programs/Program0/Section0(0): Output STOP
4 : new_Controller_0:POUs/Programs/Program0/Variables: PB1 : BOOL ;
5 : new_Controller_0:POUs/Programs/Program0/Variables: PB2 : BOOL ;
6 : new_Controller_0:POUs/Programs/Program0/Variables: STOP : BOOL ;
Matching Text: 6

```

* For information on the **Look in** Field and search options, refer to *4-8-3 Items to Set* on page 4-169.



Additional Information

- You can use shortcut keys to search. Refer to *A-6-3 Searching and Replacing* on page A-27 for details on the shortcut keys.
- If you display the Search and Replace Pane with the Ctrl + F Keys or the menu when the cursor is on a circuit part in the Ladder Editor, the corresponding text string in the following table is set as the search string.

Cursor position	Text string set as the search string
Input or output	Variable name of the input/output
Function block	Instance name of the function block
Jump	Jump label
Parameter for an input, output, function, or function block	Variable name of the parameter

- If you display the Search and Replace Pane when a text string is selected in the ST Editor, the selected text string is set as the search string.
- If you press the Ctrl + F Keys while circuits of a ladder program or text lines of an ST program are selected, the selected range is set as the search scope.

4-8-5 Replacing

Use the following procedure to search and replace a text string.

- Enter the search string that you want to replace in the **Search what** Field.
- Enter the replace string in the **Replace with** Field.
- Set the **Look in** Field and **Look at** Field, and select search options as required.*
- Click the **Search Next** Button to search for the string to replace.
- If the string is found, click the **Replace** Button to replace the string.

* For information on the **Look in** Field, the **Look at** Field, and search options, refer to *4-8-3 Items to Set* on page 4-169.

4-8-6 Searching All

Use the following procedure to search for all occurrences. The search results are displayed in the Search and Replace Results Tab Page.

- 1** Enter the search string in the **Search what** Field.
- 2** Set the **Look in** Field and **Look at** Field, and select search options as required.*
- 3** Click the **Search All** Button.

* For information on the **Look in** Field, the **Look at** Field, and search options, refer to *4-8-3 Items to Set* on page 4-169.

4-8-7 Replacing All

Use the following procedure to find and replace all occurrences of a text string. The replacement results are displayed in the Search and Replace Results Tab Page.

- 1** Enter the search string that you want to replace in the **Search what** Field.
- 2** Enter the replace string in the **Replace with** Field.
- 3** Set the **Look in** Field and **Look at** Field, and select search options as required.*
- 4** Click the **Replace All** Button.

* For information on the **Look in** Field, the **Look at** Field, and search options, refer to *4-8-3 Items to Set* on page 4-169.



Precautions for Correct Use

The targets of replacement for **Replace All** are strings within the range set in the **Look in** Field.

4-8-8 Replacing All N.O. and N.C. Inputs

Use the following procedure to find and replace all N.O. and N.C. inputs. The replacement results are displayed in the Search and Replace Results Tab Page.

- 1** Enter the variable used in the input to replace in the **Search what** Field.
- 2** Specify *Variable* name in the **Look at** Field.
- 3** Select the **Invert NO/NC Input** option.
- 4** Set the **Look in** Field and search options as required.*
- 5** Click the **Replace All** Button.

* For information on the **Look in** Field, the **Look at** Field, and search options, refer to *4-8-3 Items to Set* on page 4-169.

4-9 Program Checks

- Program Checks

You can check the programs to detect any errors in the POU's (programs, functions, or function blocks) that you created.

There are two types of program checks.

- a) Check All Programs
Checks all programs in the project.
- b) Check Selected Programs
Checks only the selected programs.

4-9-1 Check All Programs

- 1 Select **Check All Programs** from the **Project Menu**.

The results of the program check are displayed in the Build Tab Page.

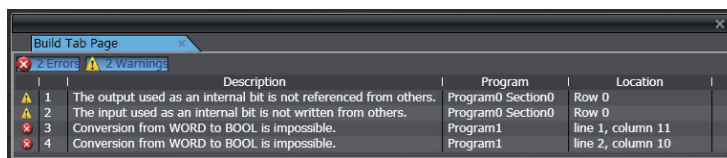

	Description	Program	Location
1	The output used as an internal bit is not referenced from others.	Program0 Section0	Row 0
2	The input used as an internal bit is not written from others.	Program0 Section0	Row 0
3	Conversion from WORD to BOOL is impossible.	Program1	line 1, column 11
4	Conversion from WORD to BOOL is impossible.	Program1	line 2, column 10

4-9-2 Check Selected Programs

- 1 Select the POU's or sections to check in the Multiview Explorer.

- 2 Select **Check Selected Programs** from the **Project Menu**.

The results of the program check are displayed in the Build Tab Page.

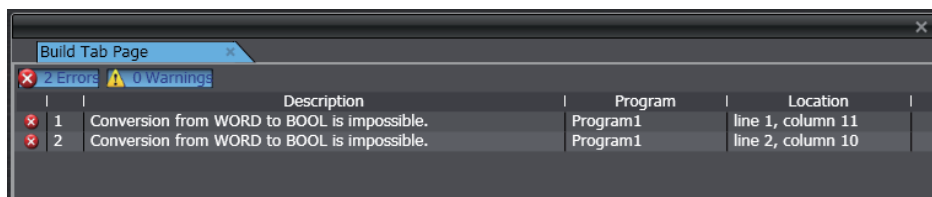



	Description	Program	Location
1	Conversion from WORD to BOOL is impossible.	Program1	line 1, column 11
2	Conversion from WORD to BOOL is impossible.	Program1	line 2, column 10

- **Program Check Result Displays**

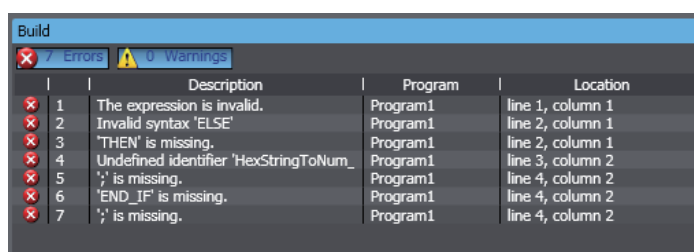
The results of a program check are displayed in the Build Tab Page as follows:

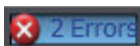
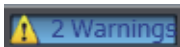

	Description	Program	Location
1	The expression is invalid.	Program1	line 1, column 1
2	Invalid syntax 'ELSE'	Program1	line 2, column 1
3	'THEN' is missing.	Program1	line 2, column 1
4	Undefined identifier 'HexStringToNum_	Program1	line 3, column 2
5	';' is missing.	Program1	line 4, column 2
6	'END_IF' is missing.	Program1	line 4, column 2
7	';' is missing.	Program1	line 4, column 2

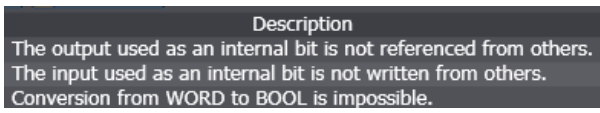
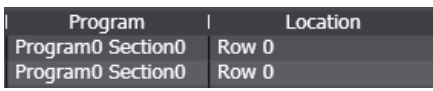
Item	Example	Meaning	Remarks
Number of errors		Displays the total number of errors.	
Number of warnings		Displays the total number of warnings.	
Error or warning number		Displays the errors or warnings in the order in which they were found.	
Description		Displays a description of the error or warning.	
Location		Displays the location where the error or warning occurred.	You can jump directly to the location of the error.



Additional Information

You can prevent specific warnings from being displayed. Refer to *8-26 Sysmac Studio Option Settings* on page 8-166 for details.

● Jumping to the Location of an Error

In the Build Tab Page, double-click the line of the error to jump to. The relevant location is displayed in the Edit Pane.

```

1  aaa:=WORD#16#FFFF;
2  IF aaa = bbb THEN (*if aaa = bbb, ccc = true*)
3    ccc := TRUE;
4  END_IF;
5  //End of program1.

```

Refer to *11-1 Error Messages for Ladder Program Checks* on page 11-2 or *11-2 Error Messages for Structured Text Checks* on page 11-7 for information on errors.

● Error Displays in the Multiview Explorer

POUs that contain an error are marked with an exclamation mark () icon.

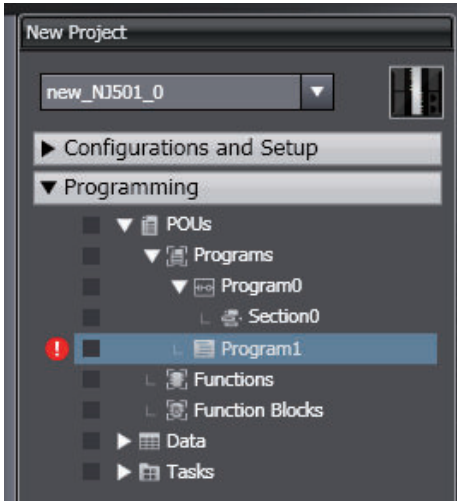

4-10 Building and Rebuilding

- Building

Building is the process of converting your project programs into a format that is executable on the CPU Unit.

A check is performed on the programs and variable data during this process. If there are any errors, the build is not performed and  is displayed next to the program or variable data where the error occurred in the Multiview Explorer. Perform a program check to see the specific errors on the Build Tab Page. After the first build, only programs that are changed are built again.

Building

The programs are automatically built when the user makes changes to them.

- **Execution Timing of Building**

If you perform no operations for five seconds after you change data types, global variables, or POU's (including local variables and algorithms), the programs are checked and the programs are built after the Edit Pane is displayed.

- **Progress of Building**

The progress of building or rebuilding the programs is displayed in a progress bar at the lower right of the window.



- **Aborting a Build Operation**

You cannot check all or some of the programs while building the programs is in progress. Cancel building to check any of the programs.

Select Abort Build from the Project Menu.

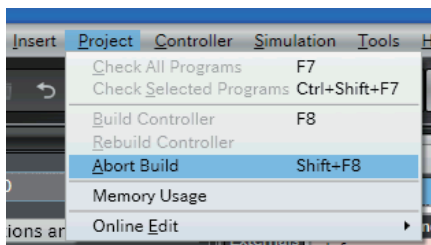

The build operation is aborted and a message that says it was aborted is displayed in the Output Tab Page.

```

Output
Information Build finished: Data Types
Information Build finished: Global Variables
Information Build finished: Cam Data Settings
Information Build finished: Program0.Variables
Information Build finished: Program0.Section0
Information Build finished: Program0
Information Build aborted.

```

● Rebuilding

A rebuild is used to build project programs that have already been built. All programs are built again.

Select **Rebuild Controller** from the **Project** Menu.

The build is started and the status during the build is displayed in the Output Tab Page.

The build is complete.



Additional Information

- The status of building is displayed for each of the following in the *Output Tab* Page.
 - a) Data types
 - b) Global variables
 - c) Cam data settings
 - d) Variable tables in POU's
 - e) Algorithms in POU's
- To redisplay all of the program errors on the Build Tab Page, execute the **Check All Programs** command.
- You can change whether building is executed automatically. Refer to *8-26 Sysmac Studio Option Settings* on page 8-166 for details.

4-11 Offline Comparison

The offline comparison operation compares the data for an open project with the data for a project file. If problems occur after you change the user program, you can search for the problems by comparing the current version of the user program with the previous version.

You can also merge data differences and print the comparison results.

4-11-1 Procedure for Offline Comparison

- 1 With the Sysmac Studio offline, select **Offline Comparison** from the **File** Menu. The Select Comparison Target Dialog Box is displayed.

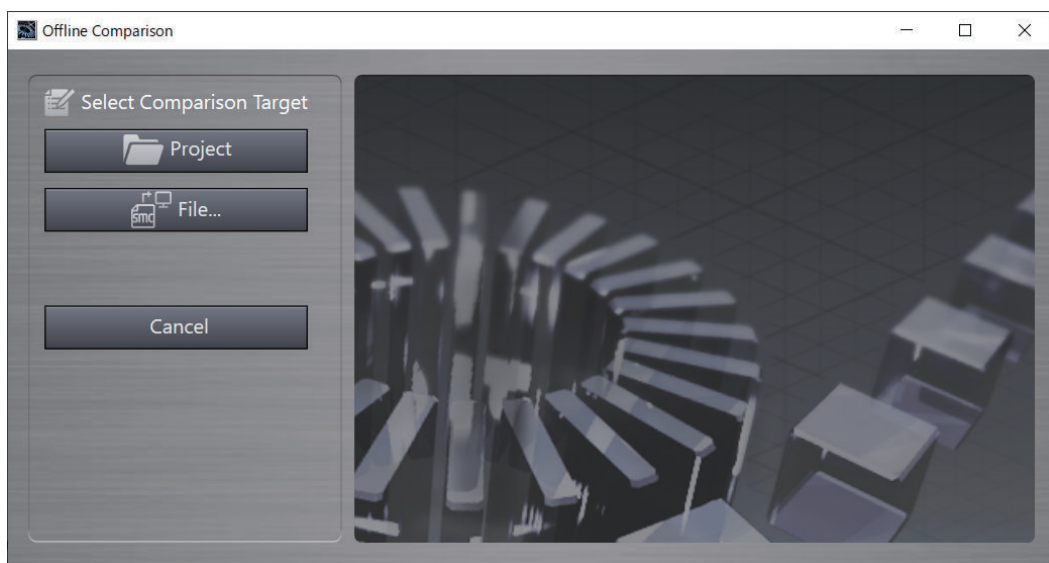

- 2 Select the project to compare and click the **Open** Button. You can either click the **Project** Button and select the project from a list, or you can click the **File** Button and select a project file (file name extension: .smc2, .csm2, .smc, or .csm). A  icon is displayed by the currently open project. The Offline Comparison Window is displayed. The data for the two projects to compare is displayed.

Left side: The currently open project

Right side: The project to compare with the currently open project

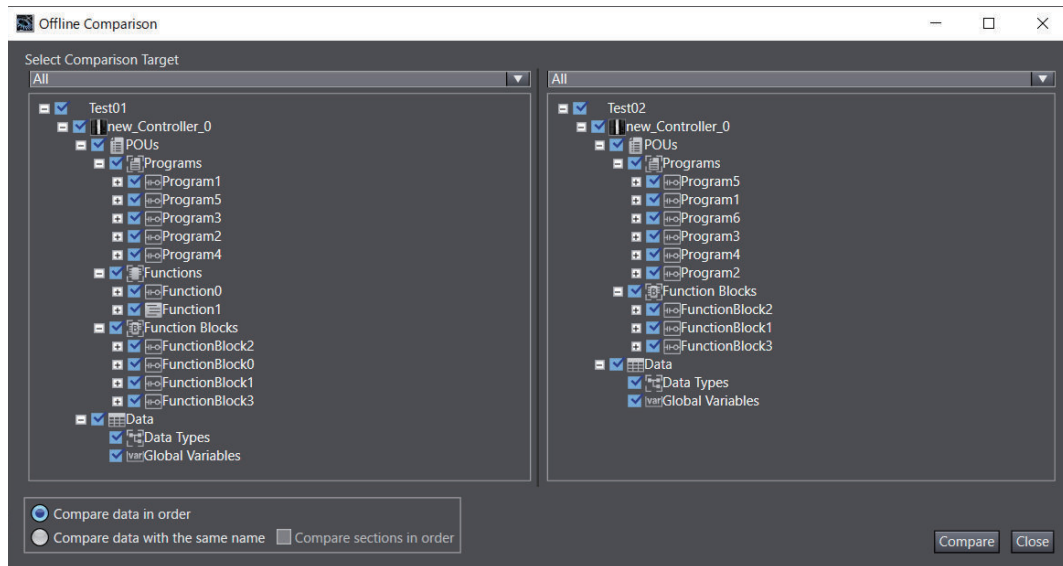

Select the data to compare between the two projects.

Item	Description
Compare data in order	The data items are compared top to bottom in the order that they are displayed in the Select Comparison Target Area.
Compare data with the same name	Data items with the same names are compared when the same names exist both in the current project and the project to compare. If you select the Compare sections in order Check Box, only section data items are compared top to bottom in the order that they are displayed in the Select Comparison Target Area.

- Select the data to compare, and then click the **Compare** Button.

To select the data to compare, select the check boxes in both of the Controller project lists.

The comparison will start.

The comparison results are displayed in the Offline Comparison Window after the comparison is completed.



Additional Information

If the project accesses a library, you can select *Referenced library* in the *Select Comparison Target* Box to compare the accessed library with the project that was used to create the library.

Offline Comparison Results

The results of the comparison are displayed as shown below.

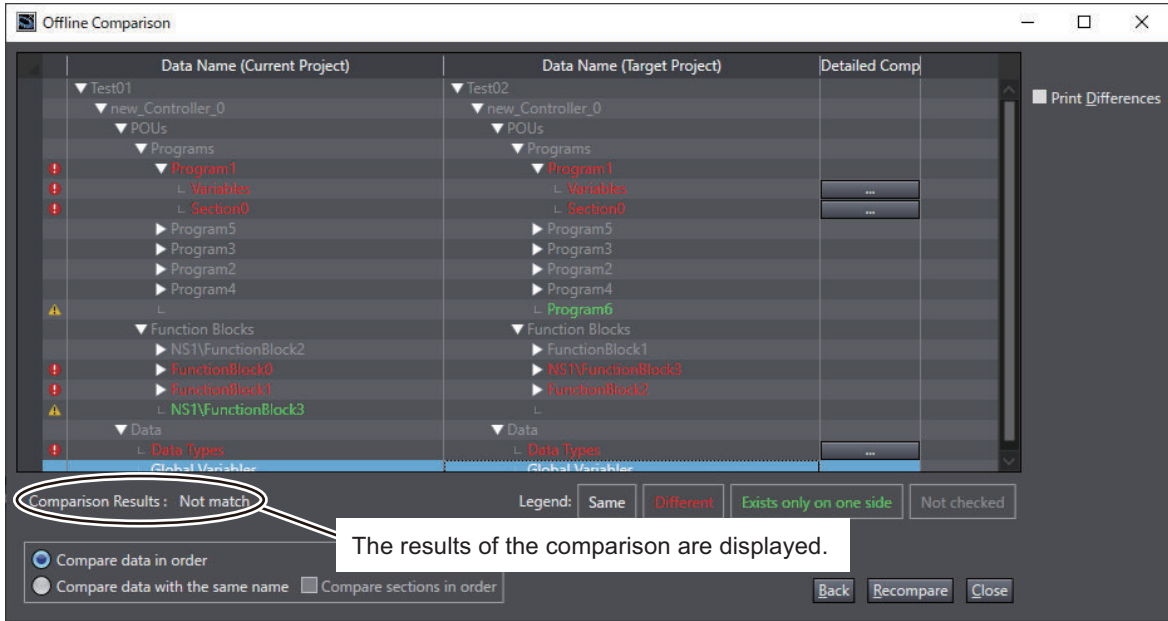

- Click the **Detailed Comparison** Button () to display detailed differences. The results of the comparison are displayed in the following colors.

Text color	Status	Description
White	Same	The data in the current project and the selected project are the same.
Red	Different	The data in the current project and the selected project are different.
Green	Exists only on one side	The data exists in only one of the projects.

If you select the **Compare data with the same name** Option, the data items in the project to compare are reordered in the same order as the current project.

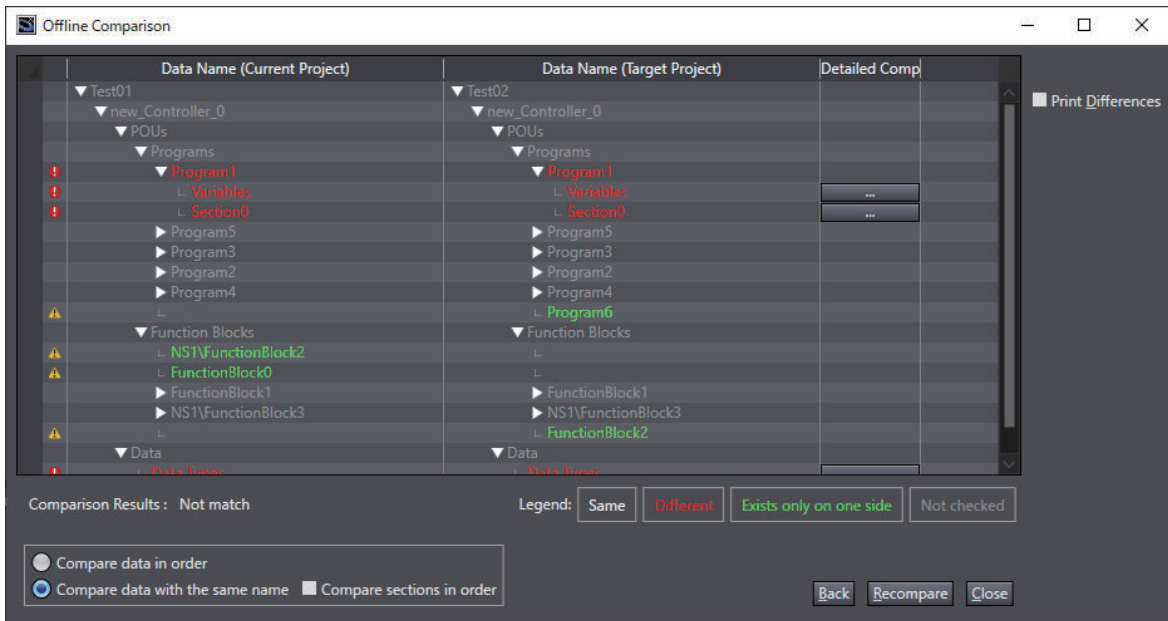

The units for comparison that are shown in the Offline Comparison Window are listed in the following table.

Data	Level	Qty	Detailed comparison	Remarks
Project name	0	1	---	
Controller name	1	N	---	
POU	2	1	---	
Programs	3	1	---	
Program	4	N	---	Ladder programs
Variable table	5	1	Available	Ladder programs
Section	5	N	Available	Ladder programs
Program	4	N	---	ST
Variable table	5	1	Available	ST
Program Body	5	1	Available	ST
Functions	3	1	---	
Function	4	N	---	Ladder programs
Variable table	5	1	Available	Ladder programs
LadderBody	5	1	Available	Ladder programs
Function	4	N	---	ST
Variable table	5	1	Available	ST
Program Body	5	1	Available	ST
Function blocks	3	1	---	
FunctionBlock	4	N	---	Ladder programs
Variable table	5	1	Available	Ladder programs
LadderBody	5	1	Available	Ladder programs
FunctionBlock	4	N	---	ST
Variable table	5	1	Available	ST
Program Body	5	1	Available	ST
Data	2	1	---	
Data types	3	1	Available	
Global variables	3	1	Available	
Libraries	2	1	---	
The data from this level depends on the structure of the library. (The data that can be compared is the same as the data that is given above.)				



Additional Information

- *Namespace-Using Declaration* for POUs is exempt from the offline comparison. Therefore, different namespaces are not determined to be different, and the comparison result will be Same.
- **You can edit the project while the Offline Comparison Window is displayed.**
If the data to compare increases or decreases as the result of editing a project while the Offline Comparison Window is displayed, close and then reopen the Offline Comparison Window, select the data to compare, and then execute the comparison again.

Detailed Comparison

Click the **Detailed Comparison** () Button to display the following window.

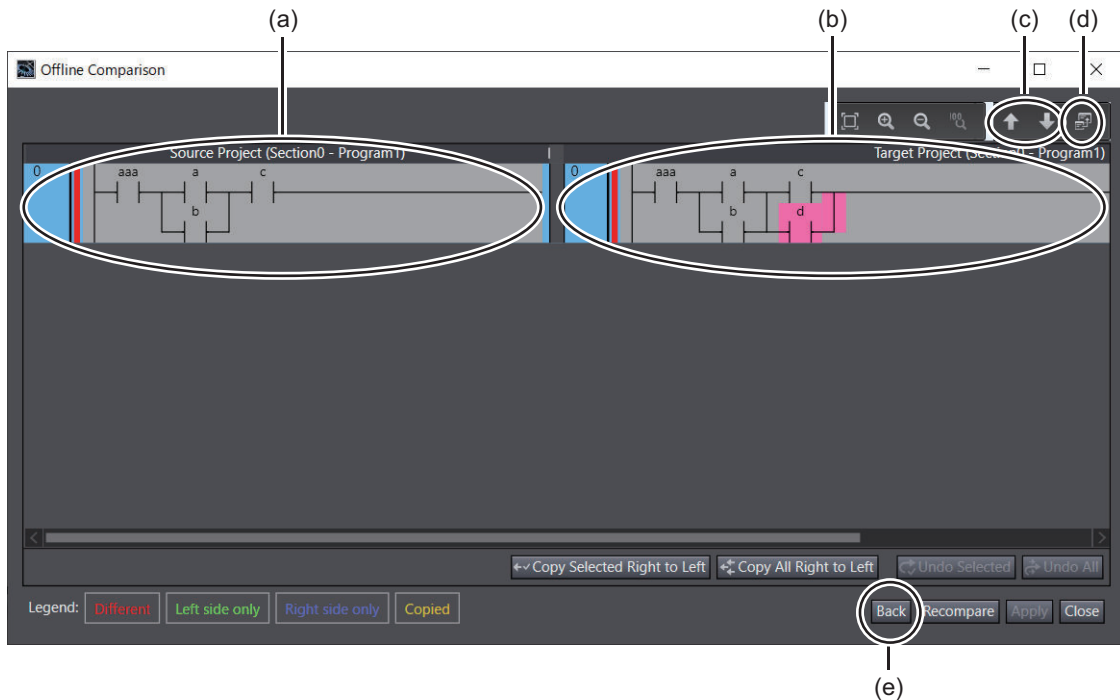

No.	Description
(a)	Programming from the currently open project.
(b)	Programming from the selected project.
(c)	Displays the next difference.
(d)	Displays the relevant location in the Editor.
(e)	Returns the display to the Comparison Results Dialog Box.

The detailed results of the comparison are displayed in the following background colors.

Background color	Meaning
No change	The rungs or lines are the same.
Red	The rungs or lines exist in both projects, but the contents are different.
Green	The rung or line exists only in the open project.
Blue	The rung or line exists only in the selected project.

Double-click a row where the data is different or select the row and click the **Jump** Button to display the corresponding program.

4-11-2 Printing Offline Comparison Results

For detailed offline comparison results, you can print and preview the differences only for items whose check boxes are selected.

You can print and preview ladder programs only.

Printing

Use the following procedure to print the comparison results.

- 1 In the **Offline Comparison** Window that displays the comparison results, select the **Print Differences** Check Box.

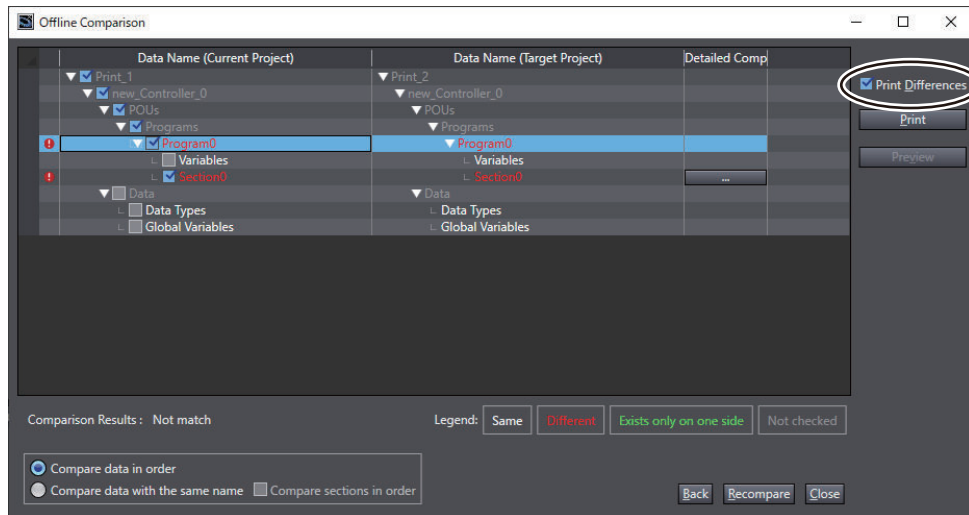

Check boxes appear to the left of the data names of the current project so that you can select the items to print.

In addition, the **Print** and **Preview** Buttons appear below the **Print Differences** Check Box.

2 Select the check boxes for the items to print.

3 Click the **Print** Button.

The **Print** Dialog Box is displayed.

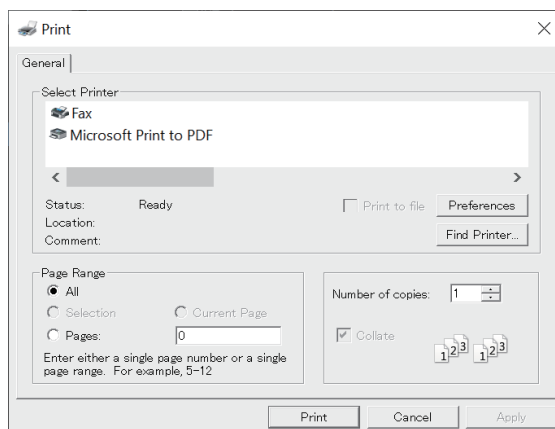

4 Select the printer to use, and then click the **Print** Button.

The selected items are printed.

● **Printing Example:**

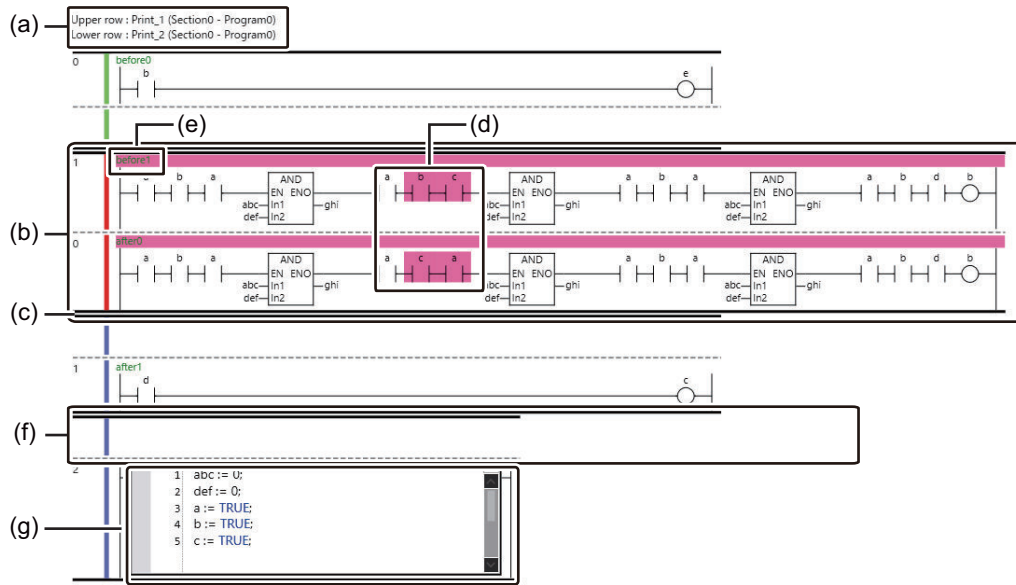

Item	Description	
(a)	At the top of the section, the project name, program name, and section name are printed.	
	Details	Upper low: Name of current project (Section name – Program name) Lower low: Name of compared project (Section name – Program name)
(b)	The rungs for the current and compared projects are printed in the upper and lower rows, respectively, with the boundary between them printed as a gray dashed line.	
(c)	The boundary between each pair of compared rungs is printed as a black double line.	
(d)	Circuit parts with differences are printed on a pink background.	
(e)	Rung comments are printed, but variable comments are not.	
(f)	If only one of the compared projects has a rung, the other project without a rung is printed blank.	
(g)	Inline ST boxes are printed in automatically adjusted height and width, according to the contents.	

Print Preview

Use the following procedure to display a print preview.

- 1** In the **Offline Comparison** Window that displays the comparison results, select the **Print Differences** Check Box.
- 2** Select the row that contains the item for which to display a print preview. The selected row is highlighted in light blue.

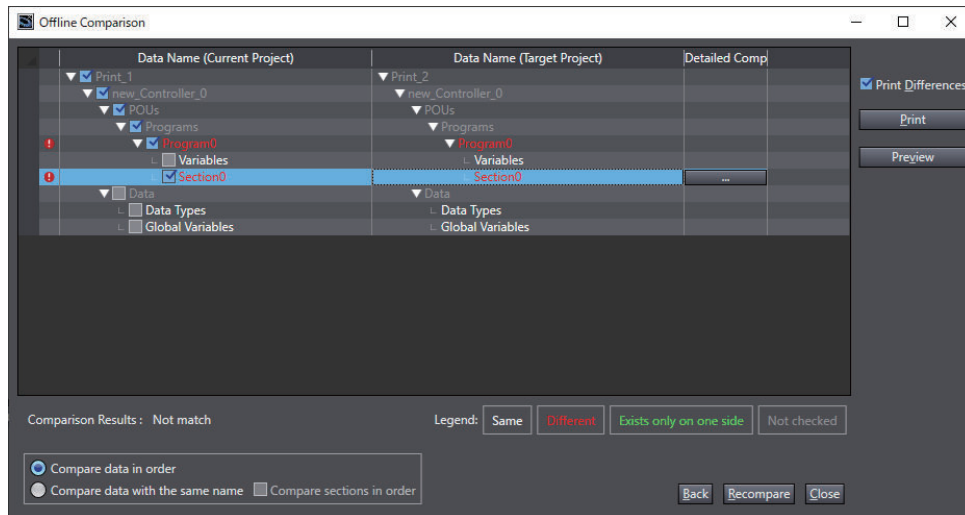

- 3 Click the **Preview** Button.
A print preview of the selected items is displayed.

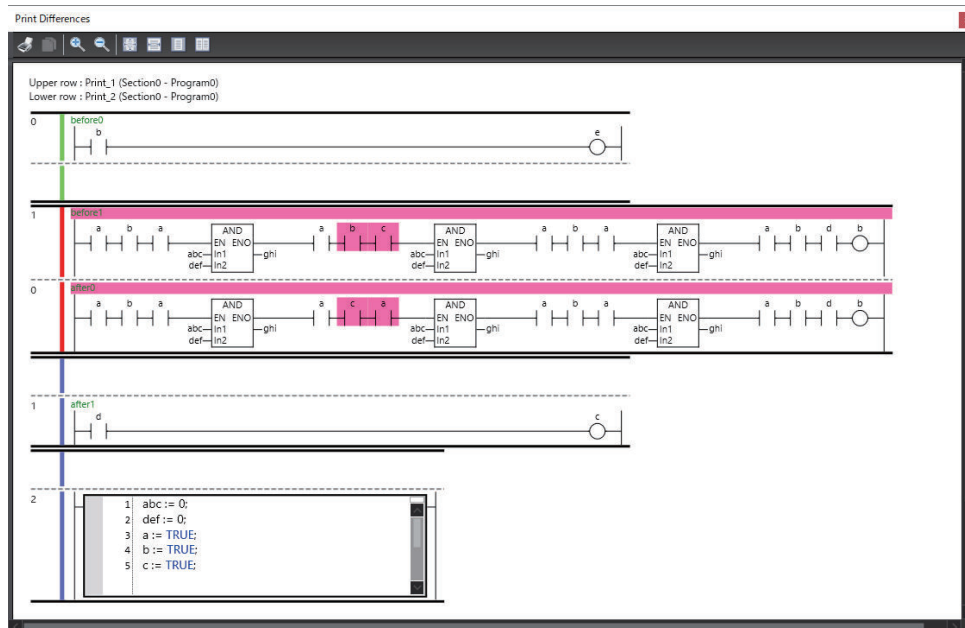

4-11-3 Merging Detailed Comparison Results

Here, merging means to unify differences in data between two projects or versions of the same project.

On the Detailed Comparison Results Dialog Box, you can copy data from the project to which the current project was compared and overwrite the data in the current project with it.

Procedure

- 1 Select the lines or rungs to merge in the Detailed Comparison Results Dialog Box and click the **Copy Selected Right to Left** Button.

If you want to merge all of the differences, click the **Copy All Right to Left** Button.

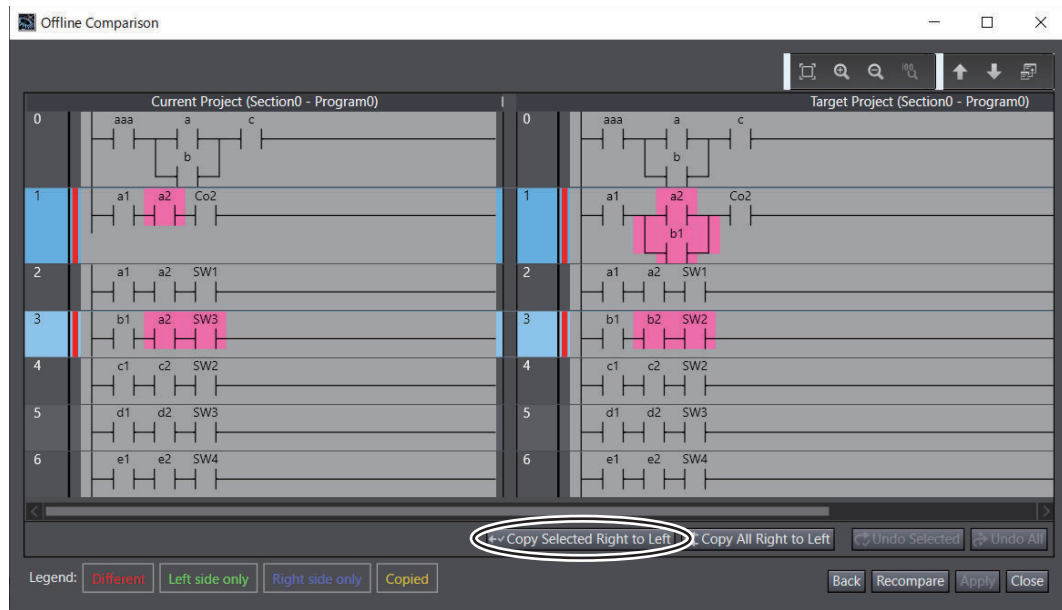

The selected lines or rungs are copied from the project to which the current project was compared to the current project.

If you clicked the **Copy All Right to Left** Button, all lines or rungs with differences are copied from the project to which the current project was compared to the current project.

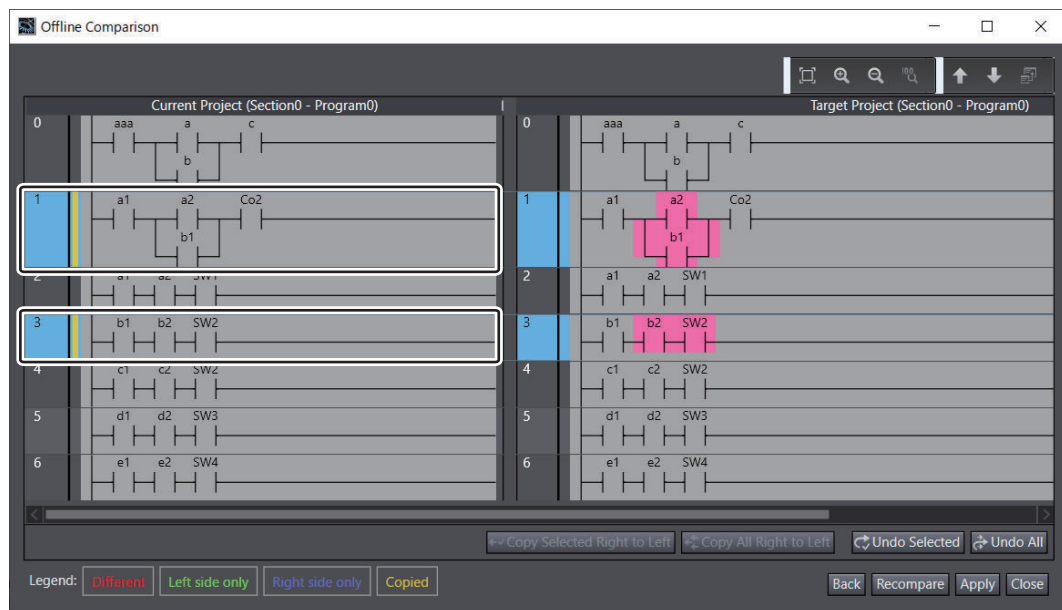

2 Click the **Apply** Button.

The changes are applied to the data for the current project.

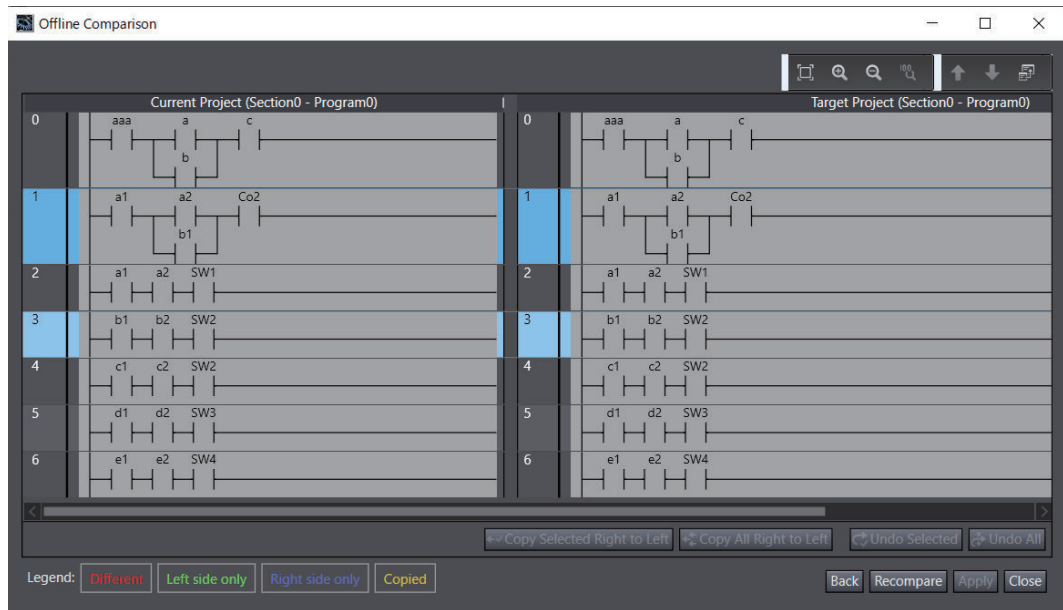

Precautions for Correct Use

The results of copying from right to left are applied to the project when the **Apply** Button is clicked. If you click the **Back**, **Recompare**, or **Close** Button before you apply the copy results, the copy results will be lost.



Additional Information

To undo the results of copying right to left, click the **Undo Selected** Button or the **Undo All** Button. You cannot undo the changes after you click the **Apply** Button.

5

Controller Configurations and Setup

This section describes the configurations and setup of a Controller.

5-1	Overview of Controller Configurations and Setup	5-3
5-2	EtherCAT Configuration and Setup	5-4
5-2-1	Procedure to Open the EtherCAT Tab Page	5-4
5-2-2	Registering Slaves Offline to Configure EtherCAT	5-4
5-2-3	Registering Slaves Online to Configure EtherCAT	5-6
5-2-4	Setting Master Parameters	5-8
5-2-5	Setting Slave Parameters	5-9
5-2-6	Exporting Slave Settings	5-15
5-2-7	Installing and Uninstalling ESI Files	5-17
5-2-8	Transferring the Network Configuration Information	5-18
5-2-9	Exporting EtherCAT Network Configuration Information	5-19
5-2-10	Printing an EtherCAT Configuration	5-23
5-2-11	Starting Vision Sensor or Displacement Sensor Setup	5-23
5-3	EtherCAT Slave Terminal Configuration and Setup	5-25
5-3-1	Creating the EtherCAT Slave Terminal Configuration	5-26
5-3-2	Transferring the Slave Terminal Configuration Information	5-34
5-3-3	Exporting the EtherCAT Slave Terminal Configuration Information	5-35
5-4	Setting EtherCAT Drives	5-37
5-4-1	Applicable EtherCAT Drives	5-37
5-4-2	Overview of the Structure of the EtherCAT Drive Tab Page	5-37
5-4-3	Setting EtherCAT Drives	5-38
5-4-4	Monitoring EtherCAT Drives	5-43
5-5	CPU/Expansion Rack Configuration and Setup	5-44
5-5-1	CPU/Expansion Racks for the NX502, NX102, or NX1P2 CPU Unit	5-44
5-5-2	CPU Rack and Expansion Racks for NJ-series CPU Units	5-55
5-6	Controller Setup	5-65
5-6-1	Operation Settings	5-65
5-6-2	Built-in EtherNet/IP Port Settings	5-71
5-6-3	Built-in I/O Settings	5-77
5-6-4	Option Board Settings	5-77
5-6-5	Memory Settings	5-78
5-7	Motion Control Setup	5-80
5-7-1	Setting Axes	5-80
5-7-2	Exporting and Importing Axis Settings	5-88
5-7-3	Deleting Multiple Axis Settings	5-96
5-7-4	Setting Axes Groups	5-97
5-7-5	Exporting and Importing Axes Group Settings	5-99

5-7-6	Deleting Multiple Axes Group Settings	5-103
5-8	Cam Data Settings	5-105
5-8-1	Registering Cam Data Settings	5-105
5-8-2	Editing Cam Data Settings	5-105
5-8-3	Procedure to Transfer Cam Data Settings	5-111
5-8-4	Importing Cam Data Settings	5-111
5-8-5	Exporting Cam Data Settings	5-112
5-8-6	Exporting Cam Tables	5-113
5-8-7	Transferring Cam Tables from the Controller to Files	5-114
5-8-8	Transferring Cam Tables from Files to the Controller	5-115
5-8-9	Superimposing Cam Tables	5-116
5-8-10	Registering Cam Definitions	5-117
5-8-11	Transferring Cam Definitions	5-121
5-8-12	Updating Cam Definition Settings	5-123
5-9	Task Settings	5-125
5-9-1	Registering Tasks	5-125
5-9-2	Procedure to Set Tasks	5-125
5-9-3	Task I/O Settings	5-126
5-9-4	Program Assignments	5-127
5-9-5	Settings for Exclusive Control of Variables in Tasks	5-128

5-1 Overview of Controller Configurations and Setup

The following is a list of the configurations and setups for NJ/NX/NY-series Controllers.

- EtherCAT Configuration and Setup
- EtherCAT Slave Terminal Configuration and Setup
- CPU/Expansion Rack Configuration and Setup
- Controller Setup
- Motion Control Setup
- Cam Data Settings
- Task Settings



WARNING

Check the parameters for proper execution before you use them for actual operation.



Precautions for Safe Use

If verifying revisions is not selected in the **Revision Check Method** parameter in the master settings in EtherCAT configuration, parameters are also transferred to slaves with different revisions. If an incompatible revision of a slave is connected, incorrect parameters may be set and operation may not be correct. If you disable the revision check, make sure that only compatible slaves are connected before transferring the parameters.

5-2 EtherCAT Configuration and Setup

- EtherCAT Configuration and Setup

This is the configuration in the Sysmac Studio of the EtherCAT slaves connected to the built-in EtherCAT port of the NJ/NX/NY-series Controller, and the settings of EtherCAT masters and slaves in that configuration.

In the Sysmac Studio, you can construct an **EtherCAT** configuration just like you would put together with the actual physical devices.

Select **Configurations and Setup - EtherCAT** in the Multiview Explorer to open the Edit Pane to create the EtherCAT Configuration. You can set up devices by dragging slaves from the device list displayed in the Toolbox to the locations where you want to connect them.



Precautions for Correct Use

If the Controller model is changed from a CPU Unit with unit version 1.40 or later to a CPU Unit with unit version earlier than 1.40, the unsupported EtherCAT settings are discarded.

5-2-1 Procedure to Open the EtherCAT Tab Page

Double-click **EtherCAT** under **Configurations and Setup** in the Multiview Explorer. Or, right-click **EtherCAT** under **Configurations and Setup** and select **Edit** from the menu.

The EtherCAT Tab Page is displayed in the Edit Pane.

5-2-2 Registering Slaves Offline to Configure EtherCAT

- Procedure to Register Slaves on the EtherCAT Tab Page

1 Drag a slave from the **Toolbox** to the master in the EtherCAT Tab Page. Or, select the master on the EtherCAT Tab Page, and then double-click the slave in the **Toolbox**.
The slave is added under the master.

2 As in step 1, drag a slave from the **Toolbox** to the slave to connect it to in the EtherCAT Tab Page. Or, select the slave to connect to on the EtherCAT Tab Page, and then double-click the slave in the **Toolbox**.
The slave is added under the selected slave.

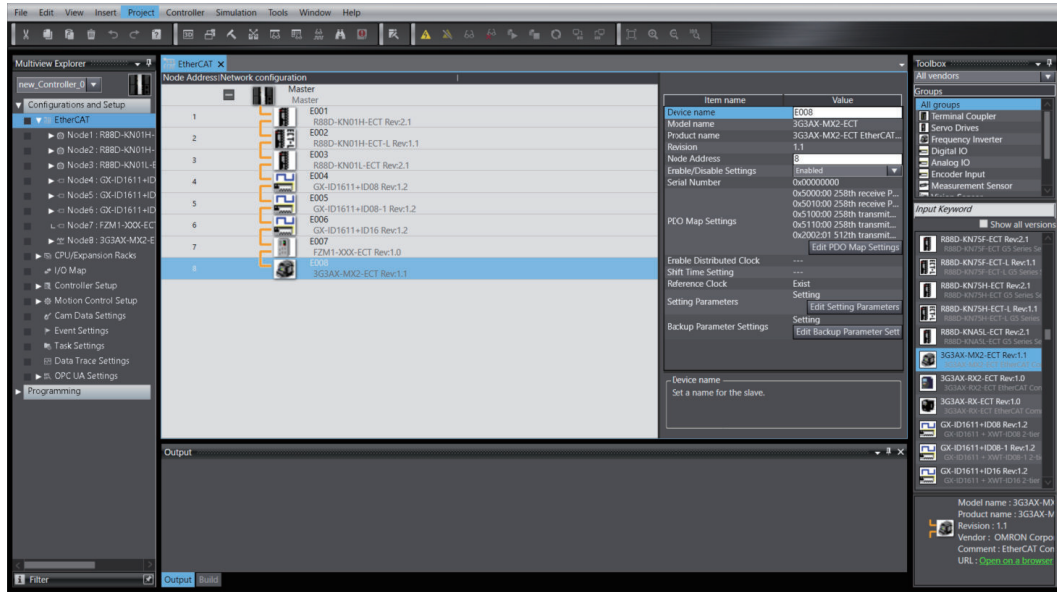

- 3** Change the node address of the slave that you added to the EtherCAT Tab Page to the node address of the physical slave.



Additional Information

- You can right-click a slave in the EtherCAT Tab Page and select **Reset Node Address** from the menu to set the node address to the lowest node address that is not used by another slave.
- If a slave has a hierarchical structure, you can expand and collapse the structure. Right-click a slave with the icon that indicates a hierarchy and select **Expand All** or **Collapse All**.
- For the hierarchical structure of a slave, you can configure a maximum of 30 levels, where the master is the first level.
- For CPU Units with unit version 1.40 or later, you can also prepare a ring topology configuration in which cables are connected in a ring shape to make a communications path redundant. Refer to the *NJ/NX-series CPU Unit Built-in EtherCAT Port User's Manual (Cat. No. W505)* for details.

● Procedure to Delete Slaves from the EtherCAT Tab Page

Right-click the slave to delete and select **Delete** from the menu.

The slave is deleted.

● Procedure to Cut and Paste Slaves on the EtherCAT Tab Page

- 1** Right-click the first slave to move and select **Cut** from the menu.
- 2** Right-click the master or slave to which to connect the slaves that you cut and select **Paste** from the menu.
The result is that the slaves are moved in the network.



Precautions for Correct Use

If you delete or cut a slave that is assigned to an axis, the assignment to the axis is deleted. If necessary, assign the slave to the axis again.



Additional Information

The cut/paste operation for slaves moves the selected slave and all the slaves that are connected after it.

● Procedure to Copy and Paste Slaves on the EtherCAT Tab Page

- 1 Right-click the first slave to copy and select **Copy** from the menu.
- 2 Right-click the slave to connect the copied slaves to and select **Paste** from the menu.
A copy of the slave is pasted.



Additional Information

Copying and pasting a slave operates on the selected slave and slaves that are connected to the lower layer. It is also possible to copy and paste it from another project.

When you copy a slave, all settings except for the device name and node address are copied with it. When you paste a slave, the device name and node address are automatically set to values that are not used by other slaves.

5-2-3 Registering Slaves Online to Configure EtherCAT

● Procedure to Automatically Create the Network Configuration on the Sysmac Studio from the Actual EtherCAT Network Configuration

- 1 Go online and right-click the master in the EtherCAT Tab Page and select **Write Slave Node Address**.
The **Slave Node Address Writing** Dialog Box is displayed.
- 2 If the present value for the node address for a slave is 0 or if the same address is assigned to more than one slave, set or correct the node address in the set value column and click the **Write** Button.
(If the correct node addresses are set for all of the slaves, click the **Cancel** Button.)

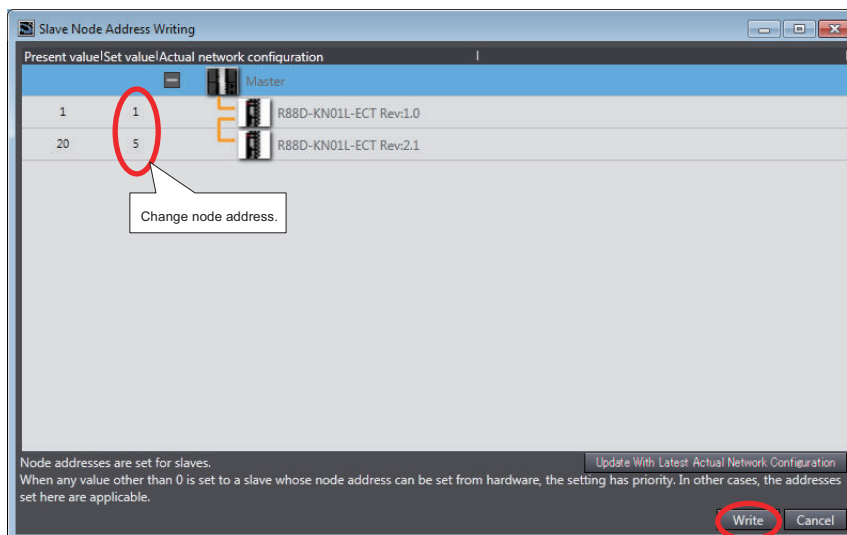

The node address is written to the physical slave.

- 3 Cycle the power supply to the slave for which **Set value** of the node address is changed. The set node address becomes valid.
- 4 Click the **Update With Latest Actual Network Configuration** Button. The present values of each slave node address are read and **Present value** of node addresses are updated. Check that **Present value** and **Set value** of the node address for all slaves show the same values, and close the **Slave Node Address Writing** Dialog Box.
- 5 Right-click the master in the EtherCAT Tab Page and select **Compare and Merge with Actual Network Configuration**.

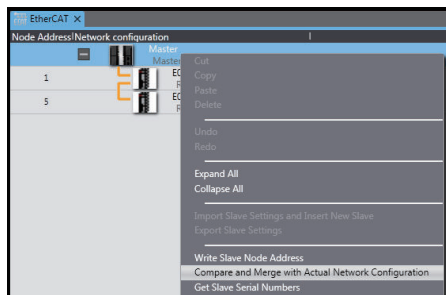

The actual network configuration is read and compared with the network configuration on the Sysmac Studio. The results are displayed in the **Compare and Merge with Actual Network Configuration** Dialog Box.

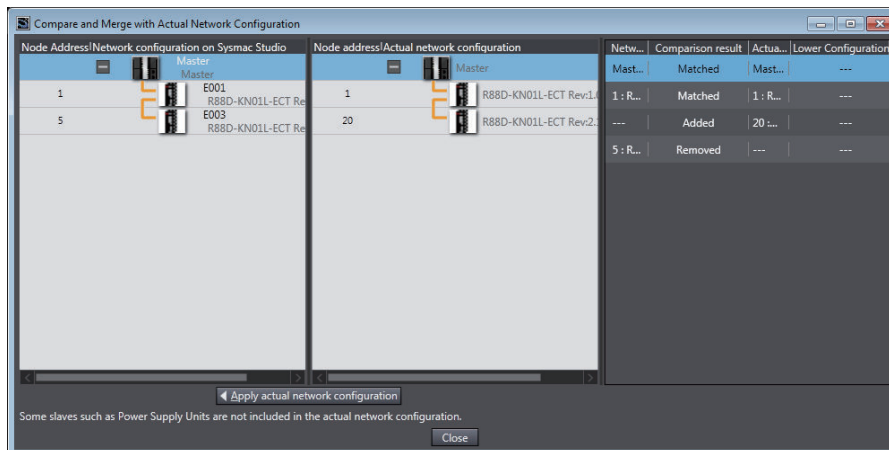

- 6 Click the **Apply actual network configuration** Button.
- 7 The actual network configuration is duplicated in the network configuration, and the Comparison results Column shows that everything in the configurations agree. (The network configuration on the is created based on the actual network configuration.) The network configuration on the Sysmac Studio will be the same as the actual network configuration.
- 8 Click the **Close** Button.

Returns the display to the EtherCAT Tab Page.



Precautions for Correct Use

- In any of the following cases, the **Compare and Merge with Actual Network Configuration** Dialog Box or the **Slave Node Address Writing** Dialog Box may not be displayed, but an error message or error dialog box may be displayed.
 - a) If there are slaves exceeding the maximum number.
 - b) If there are slaves exceeding the maximum configurable number of levels in the hierarchical structure, which is 30.
 - c) If the wiring of communications cables between the master and slaves is not correct.
 - d) If there is a slave for which the node address is not set or the same address is set for more than one slave in the actual network configuration.

According to the contents of the message, set the wiring or node address correctly and try again. For details, refer to the *NJ/NX-series CPU Unit Built-in EtherCAT Port User's Manual (Cat. No. W505)* or the *NY-series Industrial Panel PC / Industrial Box PC Built-in EtherCAT Port User's Manual (Cat. No. W562)*.

- A warning dialog box is displayed if a Node Duplicated Address Error has occurred for the network structure on the Sysmac Studio and you click the **Apply actual network configuration** Button to automatically create the network configuration on the Sysmac Studio. If you click the **Apply** Button, any of the following configuration and settings that were previously set on the Sysmac Studio are discarded: network configuration, master settings, and any slave settings (including enable settings, PDO map settings, setting parameter settings, backup parameter settings, device variable assignments in the I/O map, slave assignments to Axis Variables registered in the axis settings, and master settings to control slaves that are registered in the task settings).
 - Even if you click the **Apply actual network configuration** Button, any lower-level networks of the EtherCAT slaves (such as for an EtherCAT Slave Terminal) will not be applied to the lower-level network configurations on the Sysmac Studio if those configurations do not match or cannot be compared. You must perform compare and merge operations individually for each lower-level network.
 - When the compare and merge operation is performed, the synchronization between the Sysmac Studio and the Controller is lost. Synchronize the Sysmac Studio and Controller before you perform any online operations for the slaves. Refer to *7-5-1 Transferring/Comparing Data to/from the Controller* on page 7-127 for information on the synchronization operation.
-

5-2-4 Setting Master Parameters

● Setting Master Parameters

Select the master icon to view the parameter settings for the master.

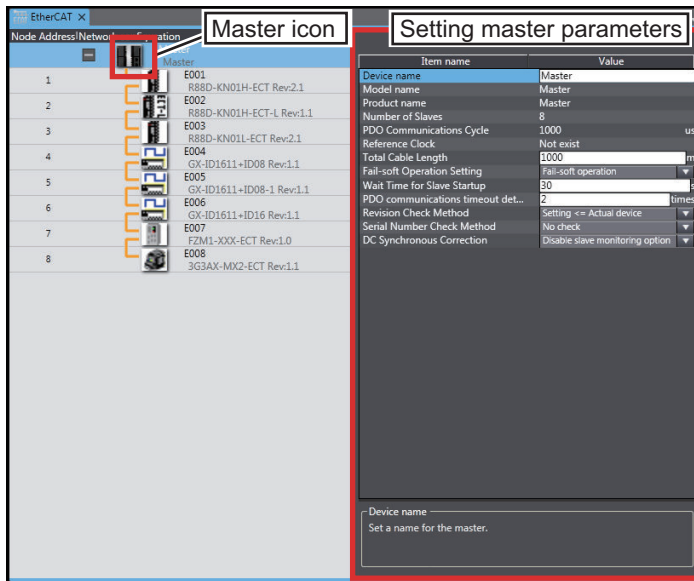

Refer to the *NJ/NX-series CPU Unit Built-in EtherCAT Port User's Manual (Cat. No. W505)* or *NY-series Industrial Panel PC / Industrial Box PC Built-in EtherCAT Port User's Manual (Cat. No. W562)* for a list of the master parameters.

5-2-5 Setting Slave Parameters

● Setting Slave Parameters

Select a slave to view the parameter settings for that slave.

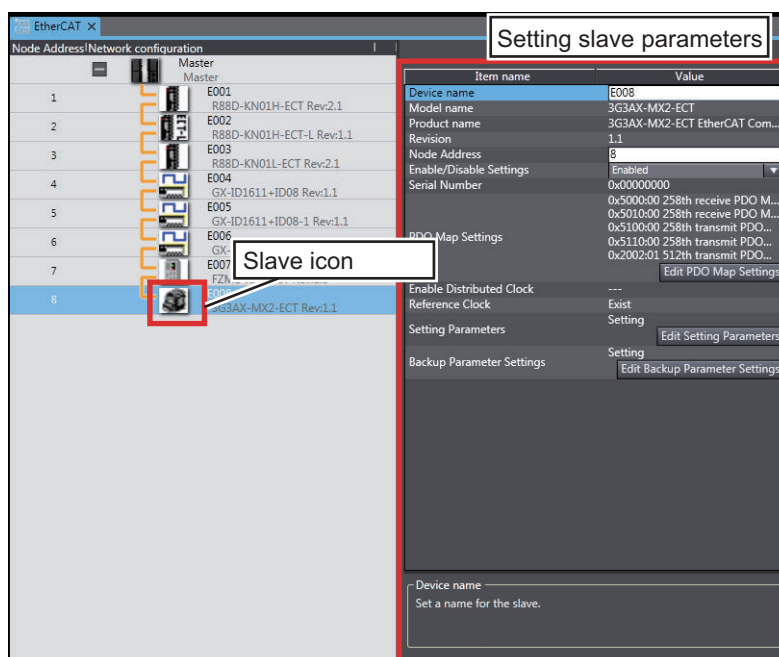

You can edit the parameters for the selected slave.

Refer to the *NJ/NX-series CPU Unit Built-in EtherCAT Port User's Manual (Cat. No. W505)* or *NY-series Industrial Panel PC / Industrial Box PC Built-in EtherCAT Port User's Manual (Cat. No. W562)* for information on slave parameters that are not described here.



Precautions for Correct Use

Make sure that the connections between the master and slaves are correct before you perform this operation.

● Procedure to Set Serial Numbers

You can get the serial numbers of all of the slaves connected to a master and apply them as the serial numbers of the slaves in the settings on the Sysmac Studio Sysmac Studio.

Use the following procedure.

Go online, right-click the master on the EtherCAT Tab Page, and select **Get Slave Serial Numbers**.

The serial numbers of the slaves are read and used as the serial numbers in the slave parameter settings.



Additional Information

A *Network Configuration Verification Error* occurs if the serial number on the Sysmac Studio and the serial number of the physical slave do not agree when the **Serial Number Check Method** in the master settings is set to **Setting = Actual device**.

● PDO Map Settings

PDO Map Settings

Objects must be mapped for communications with process data objects (PDOs) to exchange information in realtime with a fixed period.

- 1 Double-click **EtherCAT** under **Configurations and Setup** in the Multiview Explorer. Or, right-click **EtherCAT** under **Configurations and Setup** and select **Edit** from the menu. The EtherCAT Tab Page is displayed in the Edit Pane.
- 2 Select the slave and then click the **Edit PDO Map Settings** Button in the Parameter Settings Area on the right side of the tab page.

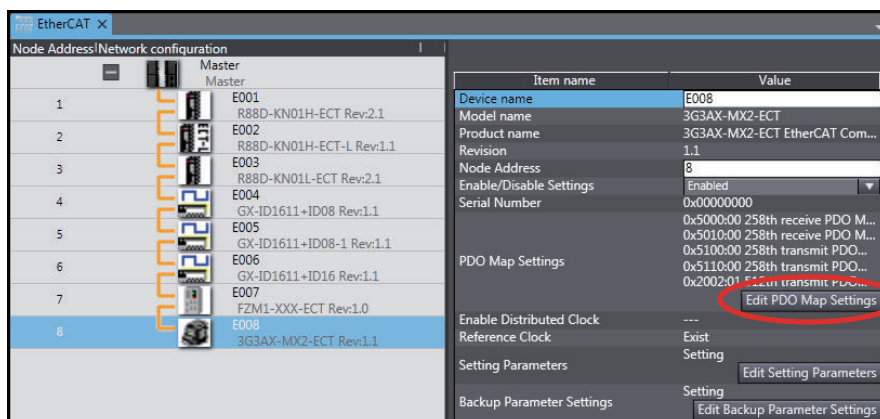

The **PDO Map Settings** Window is displayed.

- 3 Select the PDO mappings that contain the entries to exchange information for in the **PDO Map List Area**, and then click the **OK** Button.

You can add or delete **PDO** entries, change the order of **PDO** entries, or edit **PDO** entries for which **Editable** is displayed in the **Flag** Column. Refer to the *NJ/NX-series CPU Unit Built-in EtherCAT Port User's Manual (Cat. No. W505)* or *NY-series Industrial Panel PC / Industrial Box PC Built-in EtherCAT Port User's Manual (Cat. No. W562)* for details.

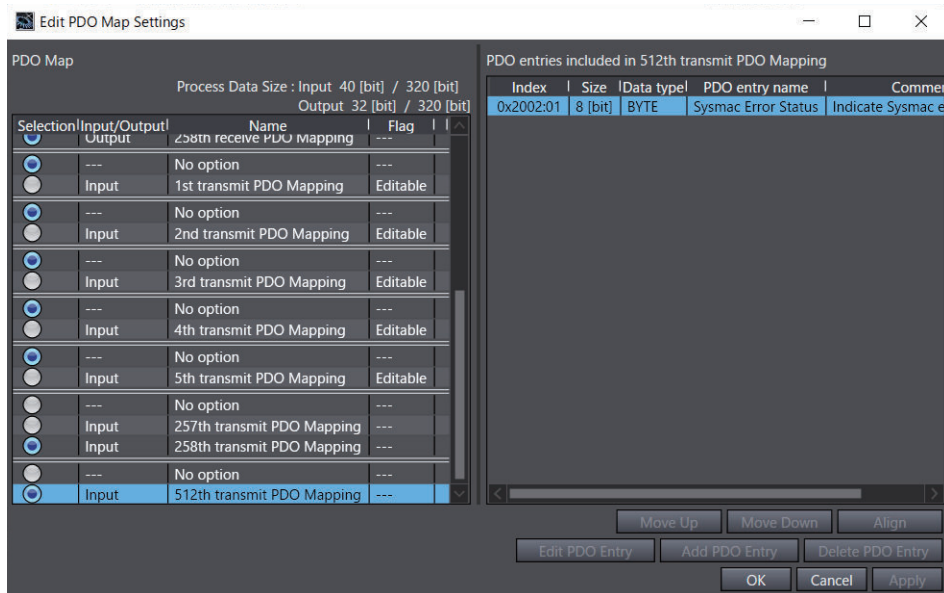

Additional Information

The default PDO mappings are selected for each slave. The display color is changed for any PDO mappings that are selected other than the default mappings and any PDO mappings for which the default PDO entries have been edited so that you can distinguish them from the default settings.

● Setting Parameter Settings

Of the parameters that are set in the slaves, the parameters that are saved in the CPU Unit are called setting parameters.

- 1 Click the **Edit Setting Parameters** Button in the Parameter Settings Area for the slave. The **Edit Setting Parameters** Dialog Box for the selected slave is displayed.

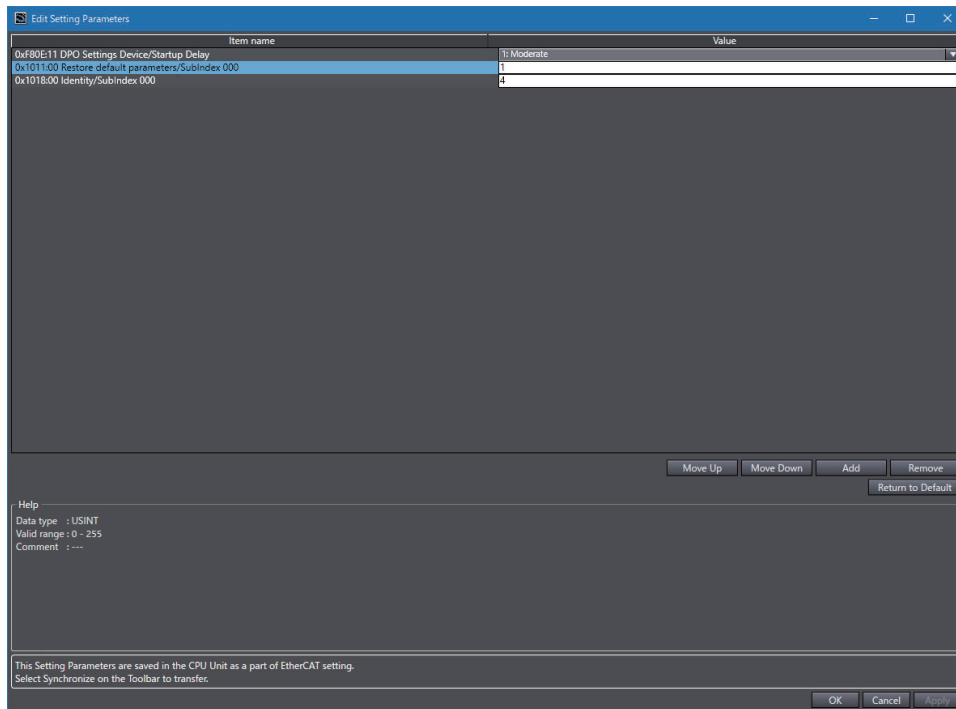

- 2 Edit the parameters, and then click the **OK** Button.



Additional Information

The parameters that are displayed in the **Edit Setting Parameters** Dialog Box are saved in the CPU Unit as part of the overall EtherCAT settings.

Default settings are defined for each slave. Items with set values that are different from the default values are displayed in a different color so that you can distinguish them.

You can click the **Return to Default** Button to restore all set values that have changed on the Sysmac Studio to the default values.



Precautions for Correct Use

The settings in the CPU Unit are not restored to the default settings as soon as you click the **Return to Default** Button.

● Backup Parameter Settings

Parameters that set for a slave and that are backed up in the slave are called backup parameters.

- 1 Click the **Edit Backup Parameter Settings** Button in the Parameter Settings Area for the slave.

The **Edit Backup Parameter Settings** Tab Page for the selected slave is displayed.

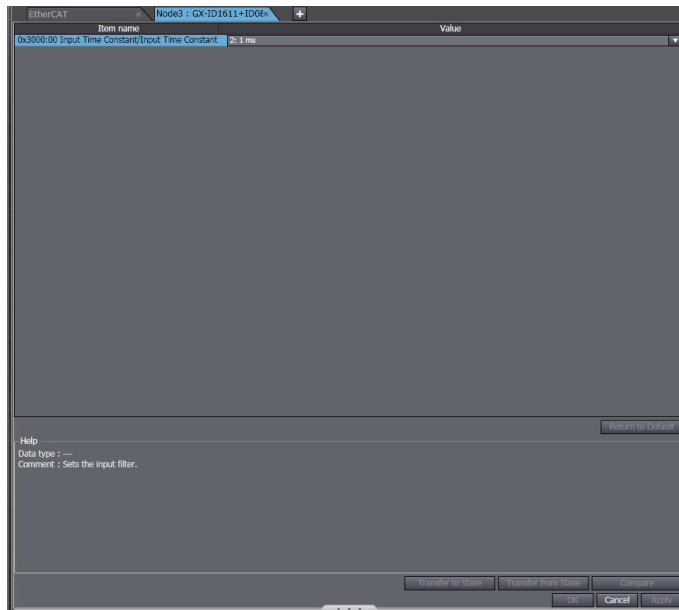

If the slave is an EtherCAT Drive, the EtherCAT Drive Tab Page is displayed. Refer to *5-4 Setting EtherCAT Drives* on page 5-37 for information on the slaves and EtherCAT Drive Tab Page.

- 2 Edit the parameters, and then click the **OK** Button.



Additional Information

The settings that are displayed in the **Edit Backup Parameter Settings** Tab Page are saved in non-volatile memory in the slaves. Refer to the manuals for the slaves for information on when these settings are actually applied to slave operation.

Default settings are defined for each slave. Items with set values that are different from the default values are displayed in a different color so that you can distinguish them.

You can click the **Return to Default** Button to restore all set values that have changed to the default values.



Precautions for Correct Use

The settings that are saved in the slaves are not restored to the default settings as soon as you click the **Return to Default** Button.

● Assigning Slaves to Axes

If you are using 1S-series or G5-series Servo Drives as slaves, you can assign them to the motion control axes that you added newly.

- 1 Right-click the master on the EtherCAT Tab Page and click **Assign Drives to Axes**.

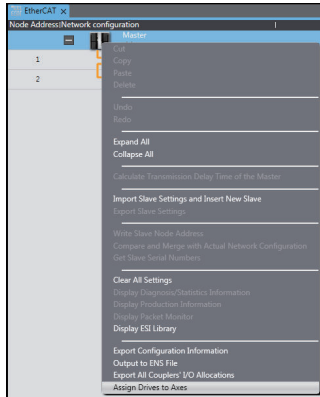

The following confirmation message is displayed.

- 2 Click the **Yes** Button.
The EtherCAT Drives that have been assigned to the added motion control axes are displayed.

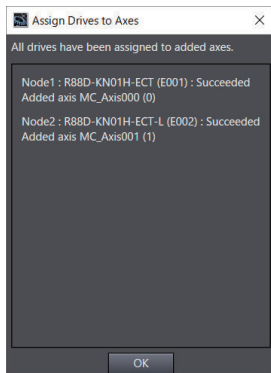

- 3 Check the display content and then click the **OK** Button.

5-2-6 Exporting Slave Settings

- 1 Right-click the slave to export settings for and select **Export Slave Settings** from the menu.

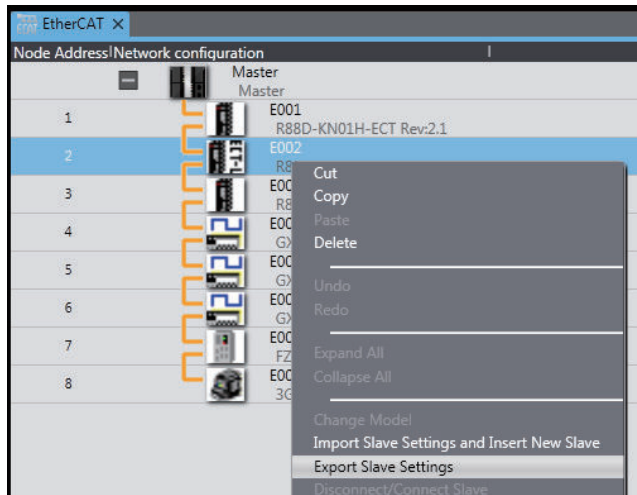

The **Save File** Dialog Box is displayed.

- 2 Enter a file name, and then click the **Save** Button.

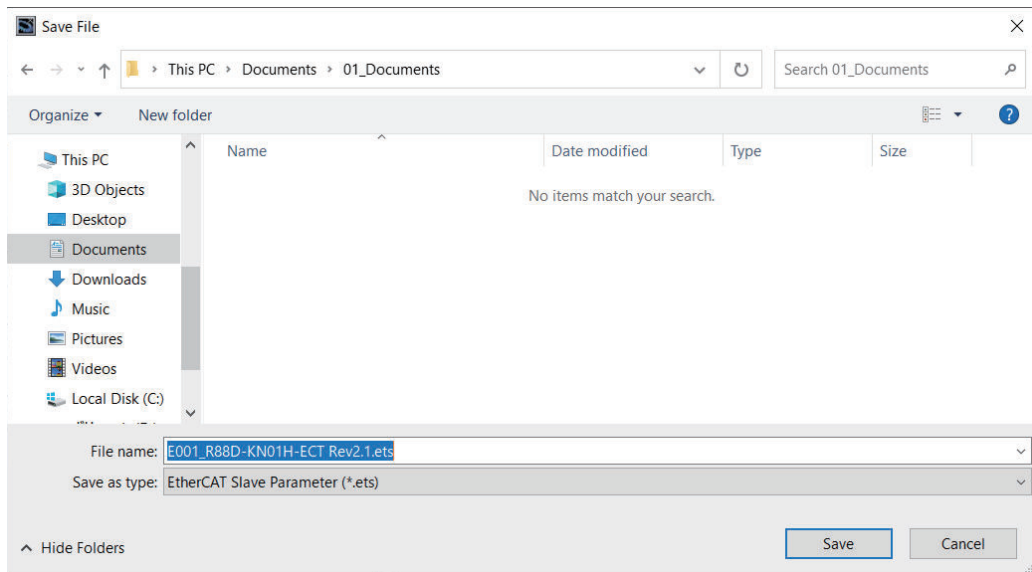

An EtherCAT slave parameter file with an .ets extension is saved.



Additional Information

All settings except for the device name and node address are saved in the EtherCAT slave parameter file. (That includes the settings that are made in the EtherCAT Drive Tab Page.)

● Importing Slave Settings

- 1 Right-click the master or slave and select **Import Slave Settings and Insert New Slave** from the menu.

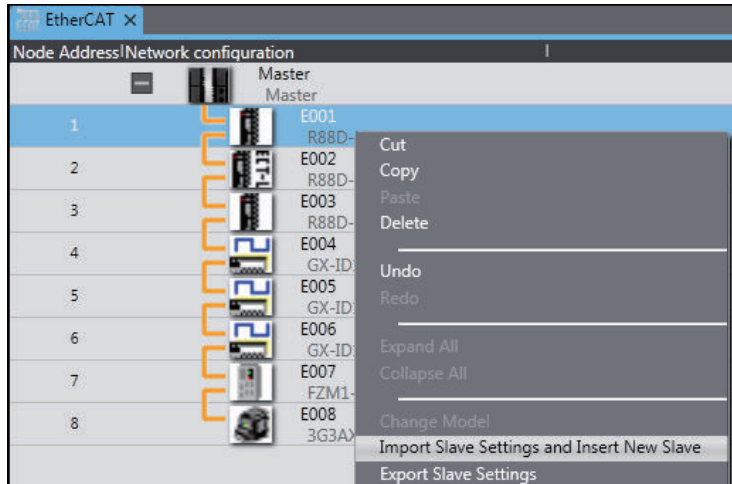

The **Open File** Dialog Box is displayed.

- 2 Select the EtherCAT slave parameter file, and then click the **Open** Button.
The slave is added to the selected master or slave according to the settings in the parameter file.

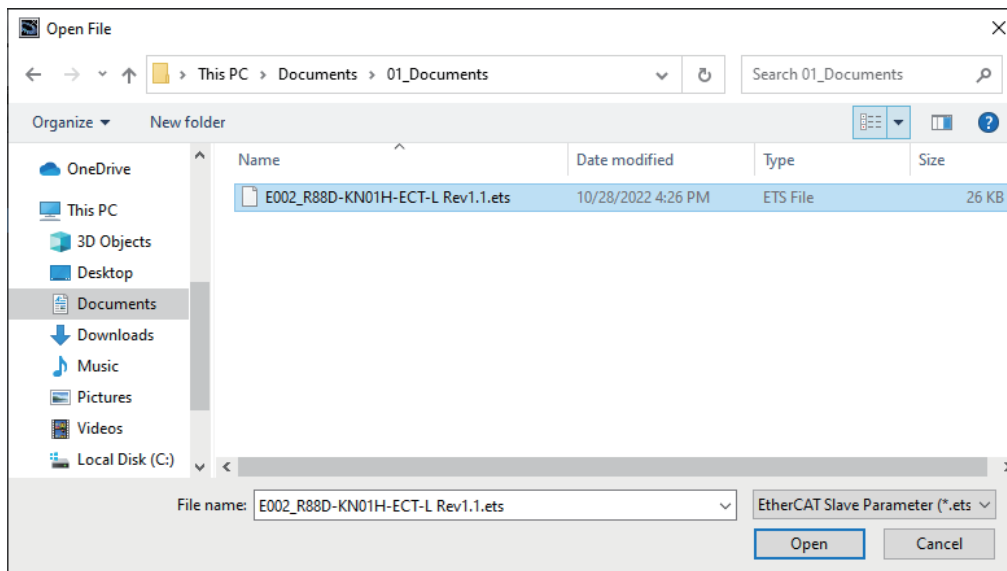

Precautions for Correct Use

You cannot import slave settings that are exported from a CPU Unit with unit version 1.40 or later into Sysmac Studio version 1.28 or lower.

5-2-7 Installing and Uninstalling ESI Files

Displaying the ESI Library

Display the installed ESI Library. You can check whether the slave definition file exists and the version.

- 1 Select the master in the EtherCAT Tab Page, right-click, and then select **Display ESI Library** from the pop-up menu.
The **ESI Library** Dialog Box is displayed.

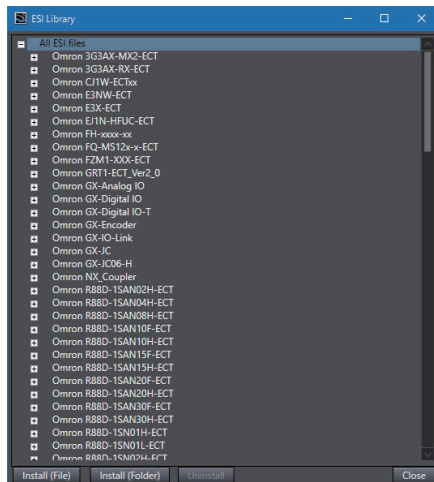

Installing ESI Files

Install the ESI files for using the slaves.

To connect to an EtherCAT slave from another manufacturer, obtain the ESI file that conforms to the most recent ETG ESI standards.

- 1 In the **ESI Library** Dialog Box, click the **Install (File)** Button or the **Install (Folder)** Button. To install an individual ESI file, select **Install (File)**, and to install all the ESI files in the folder at one time, select **Install (Folder)**.
The file selection dialog box or folder selection dialog box is displayed.
- 2 Select the ESI file or the folder in which ESI files are stored, and click the **Open** Button.
The ESI files are installed and the corresponding slaves are displayed in the **ESI Library** Dialog Box.

Uninstalling ESI Files

- 1 In the **ESI Library** Dialog Box, select the slave whose ESI file is to be uninstalled, and click the **Uninstall** Button.
The dialog box to confirm execution is displayed.

2 Click the **Yes** Button.

The ESI file is uninstalled and the corresponding slave is deleted from the **ESI Library** Dialog Box.



Precautions for Correct Use

To install and uninstall ESI files, you must log onto Windows as a user with administrator rights. If an access permission confirmation dialog box is displayed by Windows, permit access to the folder to continue.



Additional Information

- If you save or export a project that contains any EtherCAT slaves from other manufacturers with Sysmac Studio version 1.09 or higher, the ESI for the slaves is saved in the project file.*1 When you import this type of project, the creation dates/times on the source ESI files for the ESI saved in the project may be different from the creation dates/times of the ESI files installed on the computer. If they are different, a dialog box is displayed to ask you if you want to update the ESI saved in the project with the information from the ESI files on the computer.

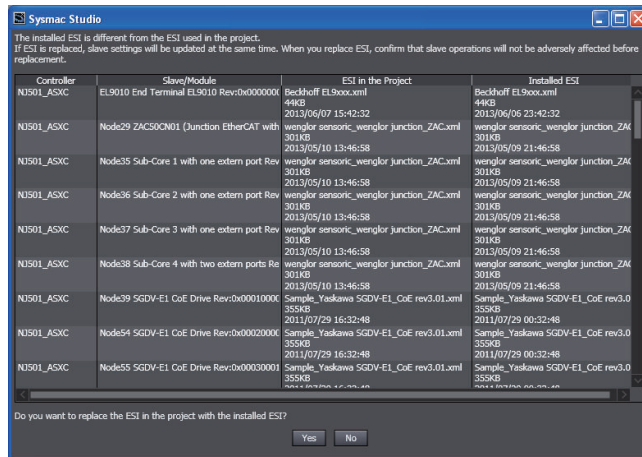

Confirm that there is no problem in overwriting the ESI saved in the project with the information from the ESI files installed on the computer. If there is no problem, update the information.

*1. Refer to 3-3-7 *Exporting a Project File* on page 3-19 for the export procedure.

- To apply any changes in an ESI file to the Controller, you must update the Configurations and Setup transfer data and then transfer it to the Controller. To update the transfer data, either edit the Configurations and Setup or use the *Update Configurations and Setup Transfer Data* menu command. You select **Update Configurations and Setup Transfer Data** from the **Tools** Menu. Refer to 8-24 *Updating the Configurations and Setup Transfer Data* on page 8-164 for details.

5-2-8 Transferring the Network Configuration Information

Use the synchronize operation to transfer the network configuration information.

Refer to *Synchronizing (Uploading/Downloading after Automatic Verification)* on page 7-127 for more information on synchronizing.

1 Go online and select **Synchronization** from the **Controller** Menu.

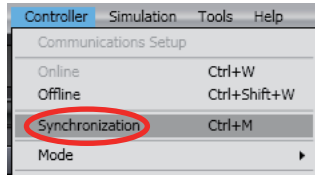

The Synchronization Window is displayed.

2 Click the **Transfer To Controller** Button.



The network configuration information is downloaded from the Sysmac Studio to the Controller.

5-2-9 Exporting EtherCAT Network Configuration Information

You can output the EtherCAT configurations to CSV files. You can use them to confirm that the EtherCAT configurations were created correctly.

● Procedure for Exporting Configuration Information

1 Right-click the master in the EtherCAT Tab Page and select **Export Configuration Information**.

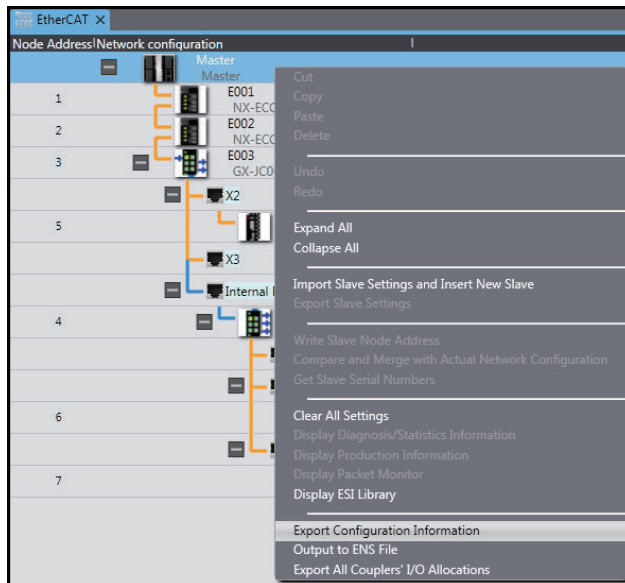

The **Browse For Folder** Dialog Box is displayed.

- 2 Select the folder in which to save the CSV files of configuration information and click the **OK** Button.

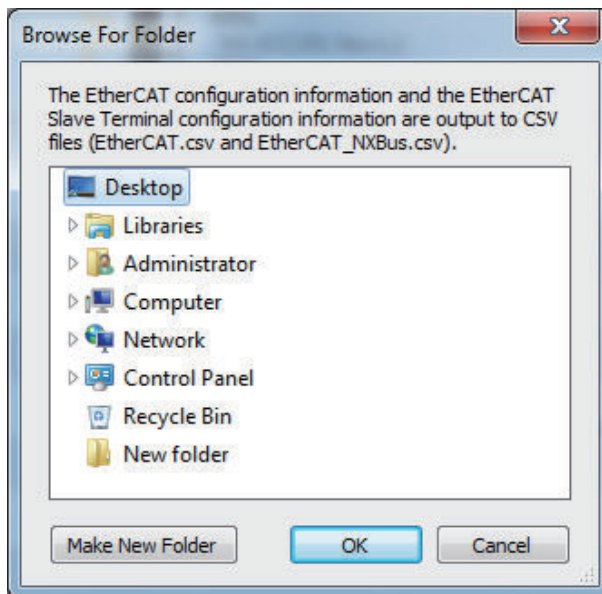

CSV files (comma delimited) that contain the EtherCAT network configuration information and the EtherCAT Slave Terminal configuration information are saved in the selected folder.

Refer to *5-3-3 Exporting the EtherCAT Slave Terminal Configuration Information* on page 5-35 for detailed information on the CSV file that contains the EtherCAT Slave Terminal configuration information.

● Interpreting the Configuration Information File Contents

This section describes how to interpret the CSV file that contains the EtherCAT network configuration information (EtherCAT.csv).

As an example, the contents of the CSV file that contains the following EtherCAT configuration is shown when opened with Excel or other spreadsheet software.

EtherCAT Configuration

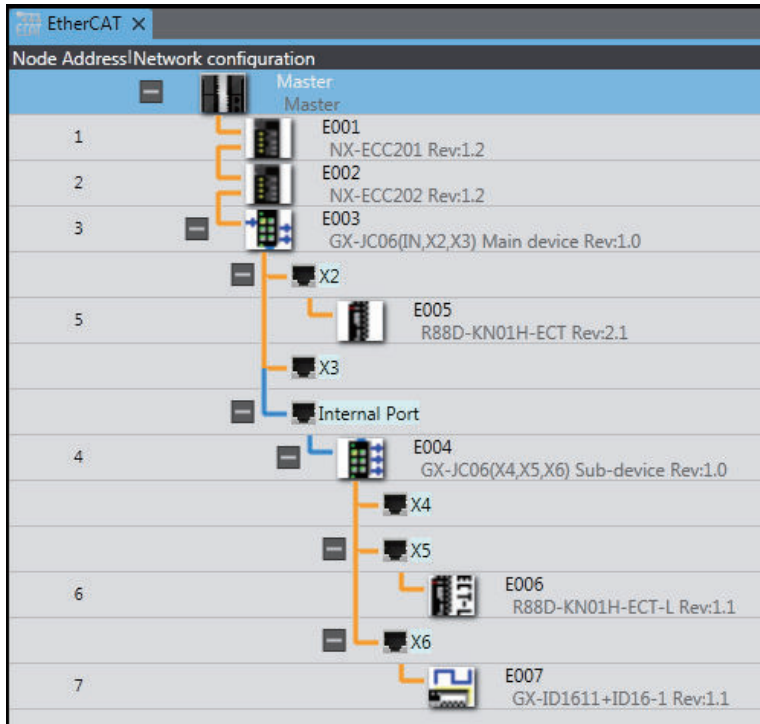

CSV File

Sysmac Studio I/O Configuration Export Format: Ver.1.0 Created: 2014-12-09T17:06:26 0308655-08.00												
Device						Path on tool		Connect from				
Node Address	Device name	Model name	Revision	Input PDO communications data size [bits]	Output PDO communications data size [bits]	Path	Node Address	Device name	Model name	Revision	Port name	
1	E001	NX-ECC201	Rev.1.2	496	96	/	Master	Master	Master	---	PortB	
2	E002	NX-ECC202	Rev.1.2	272	0	/		1	E001	NX-ECC201	Rev.1.2	PortB
3	E003	GX-JC06(N,X2,X3) Main device	Rev.1.0	0	0	/		2	E002	NX-ECC202	Rev.1.2	PortB
5	E005	R88D-KN01H-ECT	Rev.2.1	208	184	/Node3 : GX-JC06(N,X2,X3) Main device(E003)		3	E003	GX-JC06(N,X2,X3) Main device	Rev.1.0	X2
4	E004	GX-JC06(X4,X5,X6) Sub-device	Rev.1.0	0	0	/Node3 : GX-JC06(N,X2,X3) Main device(E003)		3	E003	GX-JC06(N,X2,X3) Main device	Rev.1.0	Internal Port
6	E006	R88D-KN01H-ECT-L	Rev.1.1	208	184	/Node3 : GX-JC06(N,X2,X3) Main device(E003) /Node4 : GX-JC06(X4,X5,X6) Sub-device(E004)		4	E004	GX-JC06(X4,X5,X6) Sub-device	Rev.1.0	X5
7	E007	GX-ID1611+ID16-1	Rev.1.1	40	0	/Node3 : GX-JC06(N,X2,X3) Main device(E003) /Node4 : GX-JC06(X4,X5,X6) Sub-device(E004)		4	E004	GX-JC06(X4,X5,X6) Sub-device	Rev.1.0	X6

The slave information on the EtherCAT Tab Page and the positions of the slaves in the EtherCAT configuration (paths and “connected from” slaves) are displayed. The items are described in the following table.

Item	Description	Remarks
Device	Displays information on the slaves.	
Node address	Displays the node address of the slave.	
Device name	Displays the device name of the slave.	
Model name	Displays the model number of the slave.	
Revision	Displays the revision of the slave.	
Input PDO communications data size [bits]	Displays the total input data size of the PDO mapping settings of the slave.	
Output PDO communications data size [bits]	Displays the total output data size of the PDO mapping settings of the slave.	
Path on tool	Displays the Junction Slaves through which the slaves are connected to the master on the EtherCAT Tab Page.	
Path	The Junction Slaves through which the slaves are connected are displayed as follows: /Node_address Junction_Slave_Model (Device_name) If there is no Junction Slave in the path, “/” is displayed.	If a slave is connected through more than one Junction Slave, they are displayed in order from the most upstream Junction Slave.
Connect from	Displays the slave to which a slave is connected on the EtherCAT Tab Page.	
Node address	Displays the node address of the slave to which the slave is connected.	If the slave is connected to the master, “Master” is displayed.
Device name	Displays the device name of the slave to which the slave is connected.	
Model name	Displays the model number of the slave to which the slave is connected.	
Revision	Displays the revision of the slave to which the slave is connected.	
Port name	Displays the port name of the slave to which the slave is connected.	The port name on the slave to which the slave is connected is displayed.

5-2-10 Printing an EtherCAT Configuration

You can print the EtherCAT configuration, master settings, and slave settings.

To do so, select the **EtherCAT Network Configuration and Unit Operation Settings** Check Box in the tab page to select the items to print. Refer to *8-5 Printing* on page 8-52 for the printing procedure.

If the EtherCAT configuration does not fit on one page, it will be printed on multiple pages as shown below.

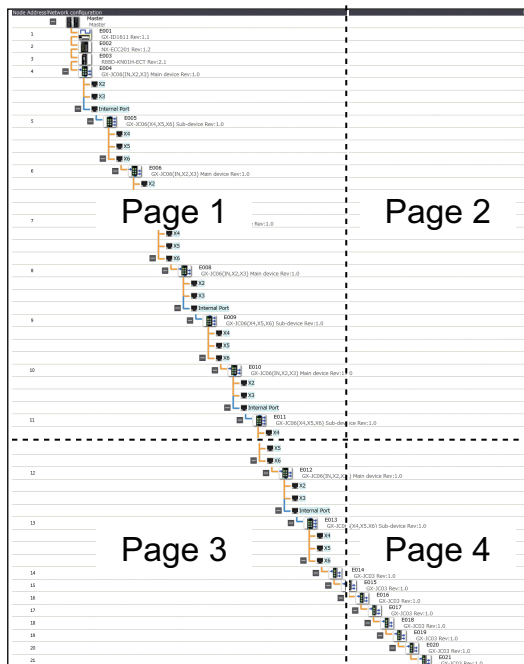

5-2-11 Starting Vision Sensor or Displacement Sensor Setup

You can display the tab page to set up a Vision Sensor or Displacement Sensor that is registered as a slave in the EtherCAT configuration.



Precautions for Correct Use

FQ-M-series Vision Sensors are not supported by the Sysmac Studio (64 bit).

Here, the procedure to set up a Vision Sensor is described as an example.

- 1 Right-click the Vision Sensor and select **Edit** from the menu.

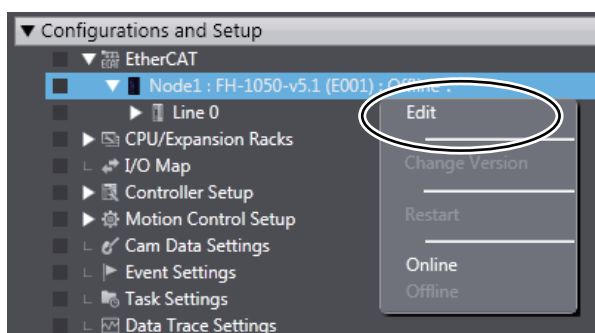

The **General Settings** view is displayed.



Additional Information

Refer to the *FQ-M-series Specialized Vision Sensor for Positioning User's Manual (Cat. No. Z314)* for the setup procedures for a FQ-M-series Vision Sensor.

Refer to the *Vision System FH/FHV Series Operation Manual for Sysmac Studio (Cat. No. Z343)* for the setting procedures for FH-series Vision Sensors.

Refer to the *ZW-series Confocal Fiber Type Displacement Sensor User's Manual (Cat. No. Z332)* for the setup procedure for a Displacement Sensor.

5-3 EtherCAT Slave Terminal Configuration and Setup

- EtherCAT Slave Terminal Configuration and Setup

The configuration of any Slave Terminal that is connected to an EtherCAT network is created on the Sysmac Studio. The NX Units that compose the Slave Terminal are set in the configuration.

A configuration in which an EtherCAT Coupler Unit, NX Units, and End Cover are connected is called an EtherCAT Slave Terminal. The Sysmac Studio is used to build the EtherCAT Slave Terminal just like you would assemble actual Units.

The EtherCAT Slave Terminal configuration is created by registering an EtherCAT Coupler Unit in the EtherCAT network configuration and then opening the Slave Terminal Tab Page from the registered EtherCAT Coupler Unit (a Communications Coupler Unit).

WARNING

If you set inappropriate parameters when you change the levels of NX Unit events, unexpected machine operation may result. Confirm that the machine will not be adversely affected before you transfer the data.



Precautions for Safe Use

- If any inappropriate parameters are set when you transfer the following settings, unexpected machine operation may result. Confirm that the machine will not be adversely affected before you transfer the data. Also, confirm that the Unit configuration, I/O allocations, and Unit operation settings are correctly set in the Slave Terminal before you start actual operation.
 - a) Communications Coupler Unit and NX Unit settings
 - b) Node address and Unit number settings for the Communications Coupler Unit and NX Units
 - c) PDO map settings for the Communications Coupler Unit and NX Units
- If inappropriate Unit configuration information is transferred to the Slave Terminal, unexpected machine operation may result. Even if appropriate Unit configuration information is set, confirm that the controlled system will not be adversely affected before you transfer the data.
- If you execute communications instructions for NX Units with inappropriate path information, unexpected machine operation may result. Confirm that the path information is correct before you start actual operation.
- After you import Communications Coupler Unit and NX Unit settings, confirm that the Unit configuration, I/O allocations, and Unit operation settings are correctly set in the Slave Terminal before you start actual operation.

Refer to the *NX-series EtherCAT Coupler Units User's Manual (Cat. No. W519)* for details on EtherCAT Slave Terminals.

5-3-1 Creating the EtherCAT Slave Terminal Configuration

Opening the Slave Terminal Tab Page to Edit the EtherCAT Slave Terminal Configuration

- 1 Double-click the EtherCAT Coupler Unit under **EtherCAT** in the Multiview Explorer. Or, right-click the EtherCAT Coupler Unit and select **Edit** from the menu. The Slave Terminal Tab Page is displayed in the Edit Pane.

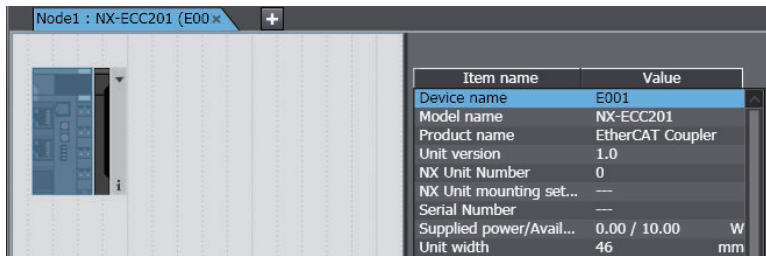

Additional Information

You can open the Slave Terminal Tab Page from the EtherCAT Tab Page in the Edit Pane with either of the following procedures.

- Right-click the EtherCAT Coupler Unit and select **Edit Slave Terminal Configuration** from the popup menu.
- Click the **Edit Slave Terminal Configuration** Button in the network setting item list.

Registering NX Units Offline (Building the Slave Terminal Configuration)

● Registering NX Units in a Slave Terminal

- 1 Drag an NX Unit from the **Toolbox** to the Slave Terminal Tab Page. The NX Unit is added.

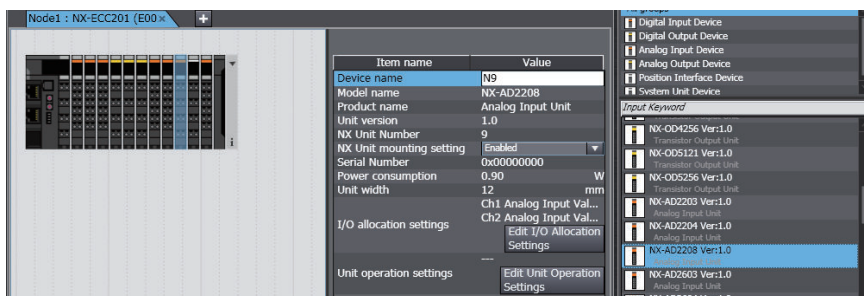

● Deleting Registered NX Units

- 1 Right-click the Unit to delete and select **Delete** from the menu. The Unit is deleted.

● Deleting all NX Units

- 1 Right-click at any location where there are no Units and select **Clear All** from the menu. All of the registered Units are deleted.

● Moving NX Units

- 1 Right-click the Unit to move and select **Cut** from the menu.
- 2 Right-click at the location where you want to insert the Unit and select **Paste** from the menu. The result is that the Unit is moved.



Precautions for Correct Use

If you delete an NX Unit that is assigned to an axis, the assignment to the axis is deleted. Also, if you move an NX Unit, the assignment to the axis may be deleted. If necessary, assign the NX Unit to the axis again.



Additional Information

You can also move the Unit by dragging it to the location where you want to insert it.

● Copying and Pasting NX Units

- 1 Right-click the Unit to copy and select **Copy** from the menu.
- 2 Right-click at the location where you want to insert the Unit and select **Paste** from the menu. The copied Unit is inserted.



Additional Information

When you copy and paste a Unit, all settings except for the device name and Unit number are copied with it. A unique device name and Unit number are set automatically.

● Switching NX Unit Displays

Use the following procedure to change between displaying Unit appearances and displaying model numbers and unit names.

- 1 Right-click in the Slave Terminal Tab Page and select **Show Model/Unit Name** from the menu. The model numbers and Unit names are displayed in boxes. To return to appearance displays, select **Show Model/Unit Name** from the menu again to remove the checkmark.

● Displaying the Slave Terminal Width

- 1 Click the  Button to the right of the Slave Terminal.

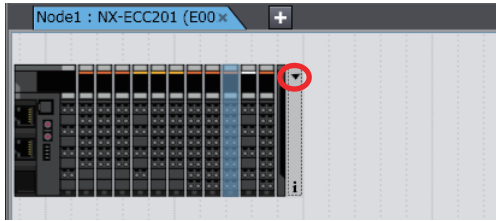

The width of the Slave Terminal is displayed.

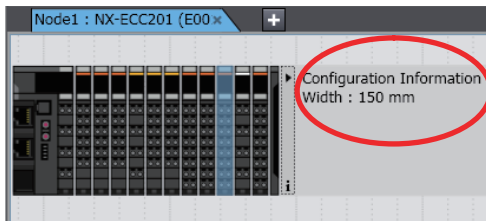

EtherCAT Coupler Unit and NX Unit Settings

This section describes the EtherCAT Coupler Unit and NX Unit settings that you can make on the Slave Terminal Tab Page.

The settings apply to both the EtherCAT Coupler Unit and the NX Units unless *NX Unit* is specified. Use the following procedure to set the Unit parameters in a Unit setting item list.

- 1 Select a Unit on the Slave Terminal Tab Page. The Unit setting item list is displayed. Use this list to allocate I/O and make the operation settings for the Unit.

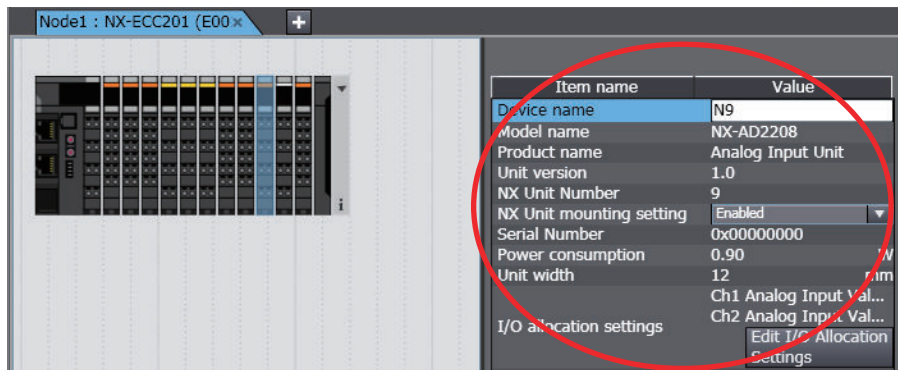

● I/O Allocation Settings

- 1 Click the **Edit I/O Allocation Settings** Button in the Unit setting item list. The I/O allocations are displayed so that you can edit them.

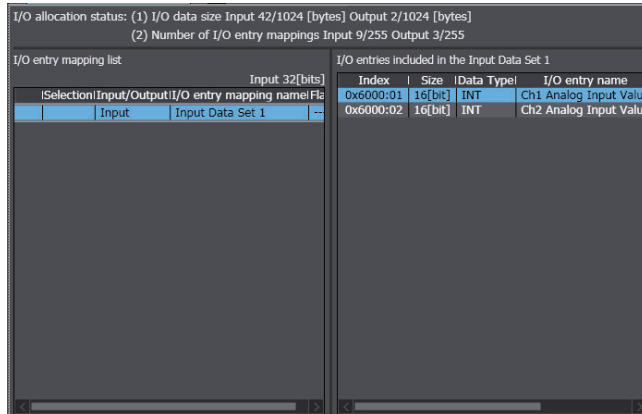

● NX Units Mounting Setting

If you disable an NX Unit that is scheduled to be added in the future, you can continue to perform Unit settings and debugging for other Units even if the disabled NX Unit does not actually exist in the Slave Terminal.

- 1 Select **Disabled** for the **NX Unit mounting setting** parameter in the Unit setting item list. An icon is displayed to show that the Unit is disabled.

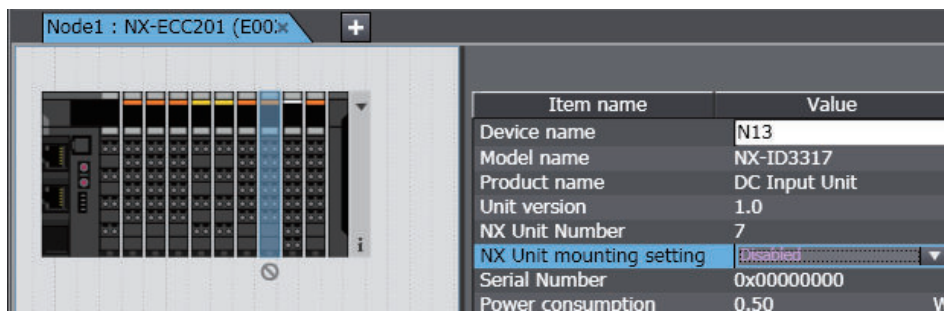

Change the setting to **Enabled** in the Unit setting item list to enable the Unit again.



Additional Information

Regardless of whether the NX Unit mounting setting parameter is set to Enabled or Disabled, the I/O allocation settings for the NX Unit are applied to the I/O data.

Operation changes as follows if the parameter is set to **Disabled**:

- If the NX Unit is not mounted, a Unit Configuration Verification Error does not occur, an NX Unit number is assigned, and the input value is locked at 0.
- If the NX Unit is mounted, a Unit Configuration Verification Error will occur.

● Unit Operation Settings

- 1 Double-click a Unit. Or, right-click the Unit and select **Edit Unit Operation Settings** from the menu.
The Edit Unit Operation Settings Tab Page is displayed.

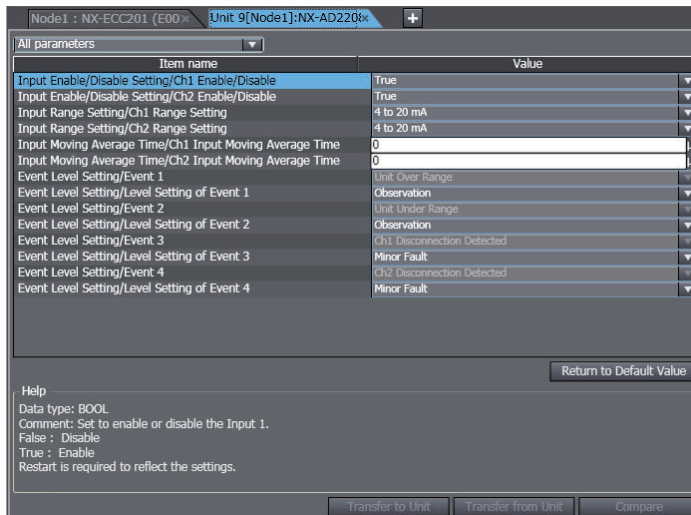

Additional Information

The specific parameters depend on the Unit. Refer to the user's manual for the specific Unit for details.

● Exporting NX Unit Settings

Use the following procedure to save the NX Unit settings in a file with an NSF file name extension.

- 1 Right-click an NX Unit on the Slave Terminal Tab Page and select **Export NX Unit Settings**. A Save File Dialog Box is displayed.
- 2 Enter the file name, and then click the **OK** Button. The file is saved.

● Importing NX Unit Settings to Insert a New Unit

Use the following procedure to import the settings from an NX Unit settings file with an NSF file name extension and use the settings to add a new NX Unit to the Slave Terminal.

- 1 Right-click a Unit on the Slave Terminal Tab Page and select **Import NX Unit Settings and Insert New Unit**. A Select File Dialog Box is displayed.
- 2 Select the file and then click the **OK** Button. An NX Unit is added to the Slave Terminal based on the settings in the file.

● Exporting All NX Unit Settings

Use the following procedure to save all the NX Unit settings in a file with an NSPF file name extension.

- 1 Right-click an EtherCAT Coupler Unit on the Slave Terminal Tab Page and select **Export All NX Unit Settings**. A Save File Dialog Box is displayed.

- 2 Enter the file name, and then click the **OK** Button.
The file is saved.

● Importing All NX Unit Settings

Use the following procedure to import all the NX Unit settings from a file with an NSPF file name extension and add newly all the NX Units included in the file.

You can import all NX Unit settings only when there is no NX Unit registered in the EtherCAT Coupler Unit.

- 1 Right-click an EtherCAT Coupler Unit on the Slave Terminal Tab Page and select **Import All NX Unit Settings**.
A Select File Dialog Box is displayed. An error message is displayed if there is any registered NX Unit. In this case, delete all the registered NX Units and select **Import All NX Unit Settings** again.
- 2 Select the file and then click the **OK** Button.
All the NX Units included in the file are added to the Slave Terminal.

Changing the Model of an EtherCAT Coupler Unit or NX Unit

Use the following procedures to change the model or unit version of an EtherCAT Coupler Unit or NX Unit that is already registered.

● EtherCAT Coupler Unit

Use the EtherCAT Tab Page to change the model of an EtherCAT Coupler Unit.

- 1 Right-click the EtherCAT Coupler Unit on the EtherCAT Tab Page and select **Change Model** from the menu.
The Units that you can change to are displayed in the Change Model Dialog Box.
- 2 Select the Unit to change to and then click the **OK** Button.
The Unit is changed to the selected model and unit version.



Precautions for Safe Use

Check the user program, data, and parameter settings for proper execution before you use them for actual operation.



Precautions for Correct Use

- If the unit version that you changed to is old and mounting an NX Unit registered in the Slave Terminal is not supported by the Sysmac Studio, an unsupported Unit error occurs for the NX Unit. Confirm that the model of the EtherCAT Coupler Unit after the change supports the NX Units on the Slave Terminal before you change the model.
- Any settings in the EtherCAT Coupler Unit before the change that are not supported by the EtherCAT Coupler Unit after the change will be lost when you change the model.
- If the performance of the EtherCAT Coupler Unit is different after changing the model, the timing of I/O may change.

● Changing NX Unit Models

- 1 Right-click the Unit for which to change the model in the Slave Terminal Tab Page and select **Change Model** from the menu.
The Units that you can change to are displayed in the Change Model Dialog Box.
- 2 Select the Unit to change to and then click the **OK** Button.
The Unit is changed to the selected model and unit version.



Precautions for Safe Use

Check the user program, data, and parameter settings for proper execution before you use them for actual operation.



Precautions for Correct Use

- If you change the model of an NX Unit that is assigned to an axis, the assignment to the axis is deleted. If necessary, assign the NX Unit to the axis again.
 - Any settings in the NX Unit before the change that are not supported by the NX Unit after the change will be lost when you change the model.
 - If the performance of the NX Unit is different after changing the model, the timing of I/O may change.
-

Registering NX Units Online (Building the Slave Terminal Configuration)

Use the following procedure to automatically create the configuration on the Sysmac Studio from the actual configuration of the Slave Terminal.

- 1 Go online, right-click in the Slave Terminal Tab Page and select **Compare and Merge with Actual Unit Configuration**.
The actual Unit configuration is read and compared with the Unit configuration on the Sysmac Studio. The results are displayed in the **Compare and Merge with Actual Unit Configuration** Dialog Box.

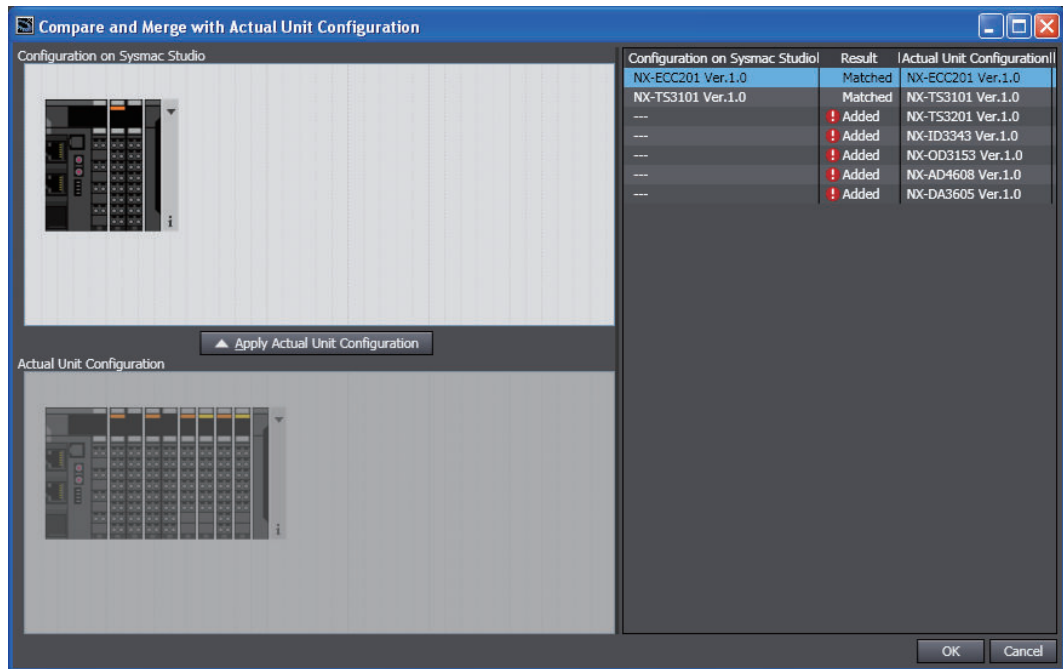

- 2 Click the **Apply actual Unit configuration** Button to synchronize with the actual Unit configuration with the Unit configuration on the Sysmac Studio.
- 3 Click the **OK** Button.
The Slave Terminal Tab Page is displayed again.



Precautions for Safe Use

Check the user program, data, and parameter settings for proper execution before you use them for actual operation.



Precautions for Correct Use

- If you automatically create the Slave Terminal configuration on the Sysmac Studio Sysmac Studio by clicking the **Apply actual Unit configuration** Button, any previously set Slave Terminal configuration, Communications Coupler Unit settings, and NX Unit settings are discarded.
To merge the Slave Terminal information without losing the current settings in the Sysmac Studio, do not use the **Apply actual Unit configuration** Button, and use the compare and merge operation to create the configuration. Refer to *7-5-1 Transferring/Comparing Data to/from the Controller* on page 7-127 for information on the compare and merge operation.
- When the **compare and merge operation** is performed for the actual Unit configuration, the synchronization between the Sysmac Studio and the Controller is lost. Synchronize the Sysmac Studio and Controller before you perform any online operations for the Slave Terminal. Refer to *7-5-1 Transferring/Comparing Data to/from the Controller* on page 7-127 for information on synchronization.
- If an NX Unit that is assigned to an axis is deleted as the result of a compare and merge operation with the actual Unit configuration, the assignment to the axis is also deleted. If necessary, assign the NX Unit to the axis again.

● Reading Serial Numbers

The serial numbers can be read from the Units in the actual Unit configuration and applied to the Slave Terminal configuration on the Sysmac Studio.

- 1 Go online, right-click in the Slave Terminal Tab Page, and select **Get Serial Numbers of All NX Units**.

A dialog box is displayed to confirm reading the serial numbers.

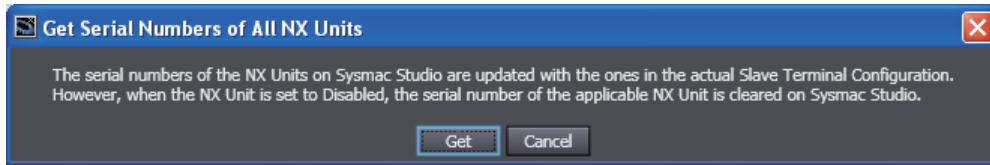

- 2 Click the **Get** Button.

The serial numbers are read from the Units in the actual Unit configuration and applied to the Units in the Slave Terminal on the Sysmac Studio.



Additional Information

If the NX Unit mounting setting parameter is set to **Disabled**, the serial number of the NX Unit is cleared to 0.

5-3-2 Transferring the Slave Terminal Configuration Information

Use the synchronize operation to transfer the Slave Terminal configuration information.

Refer to *Synchronizing (Uploading/Downloading after Automatic Verification)* on page 7-127 for details on the synchronization operation.

- 1 Go online and select **Synchronization** from the **Controller** Menu.
The Synchronization Window is displayed.
- 2 Select the EtherCAT Coupler Unit Check Box under **EtherCAT Slave Settings** in the Synchronization Window, and then click the **Transfer To Controller** Button.

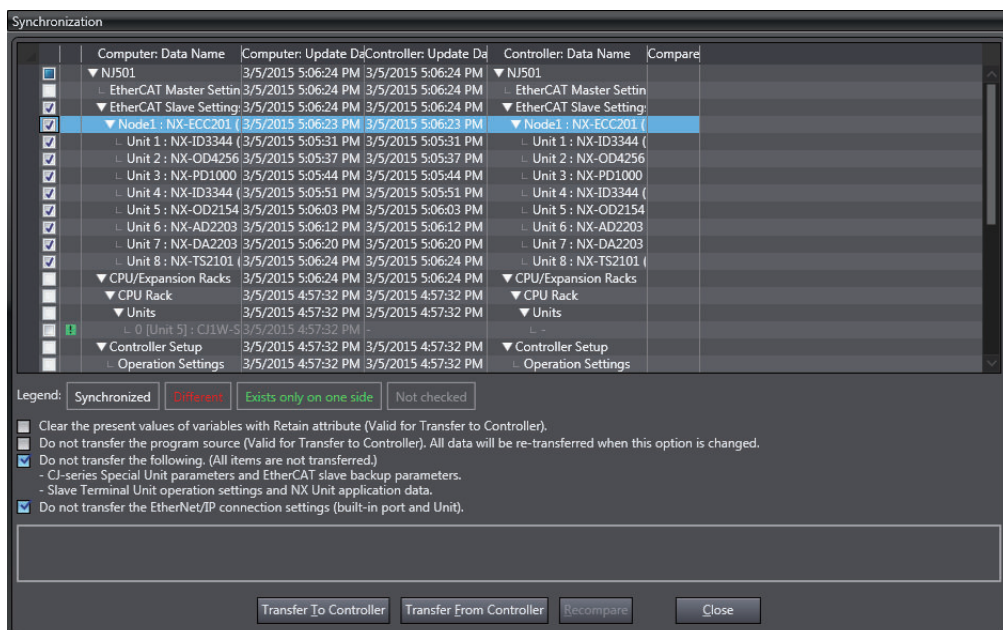

The Slave Terminal configuration information is downloaded from the Sysmac Studio to the Controller.

5-3-3 Exporting the EtherCAT Slave Terminal Configuration Information

You can output the Slave Terminal configuration to a CSV file. You can use it to confirm that the Slave Terminal configuration was created correctly.

● Procedure for Exporting Configuration Information

The Slave Terminal configuration information is exported from the EtherCAT Tab Page. Refer to *5-2-9 Exporting EtherCAT Network Configuration Information* on page 5-19 for the procedure. The Slave Terminal configuration information for all of the EtherCAT Coupler Units on the EtherCAT Tab Page is saved in the same CSV file.

● Interpreting the Configuration Information File Contents

This section describes how to interpret the CSV file that contains the Slave Terminal configuration information (EtherCAT_NXBus.csv).

As an example, the contents of the CSV file that contains the following Slave Terminal configuration is shown when opened with Excel or other spreadsheet software.

Slave Terminal Configuration

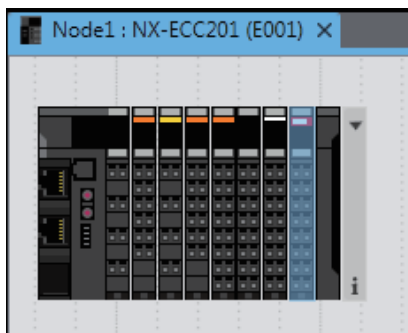

CSV File

Sysmac Studio I/O Configuration Export Format: Ver.1.0 Created: 2014-12-09T17:06:26.0464655-08:00							
UpperDevice	Device						
Node Address	Device name	NX Unit Number	Device name	Model name	Unit version	Input allocated data size [bits]	Output allocated data size [bits]
1	E001	0	E001	NX-ECC201	Ver.1.2	264	0
1	E001	1	N1	NX-ID3317	Ver.1.0	4	0
1	E001	2	N2	NX-OC2633	Ver.1.0	0	2
1	E001	3	N3	NX-AD3204	Ver.1.0	64	0
1	E001	4	N4	NX-TS3201	Ver.1.1	64	0
1	E001	5	N5	NX-PC0010	Ver.1.0	0	0
1	E001	6	N6	NX-SID800	Ver.1.0	80	80

The EtherCAT Coupler Unit information and NX Unit information in the Slave Terminal configuration are displayed.

The items are described in the following table.

Item	Description
Upper device	Displays the EtherCAT Coupler Unit information on the EtherCAT Tab Page.

Item	Description
Node address	Displays the node address of the EtherCAT Coupler Unit.
Device name	Displays the device name of the EtherCAT Coupler Unit.
Device	Displays information on the NX Units in the Slave Terminal configuration.
NX Unit number	Displays the unit number of the NX Unit.
Device name	Displays the device name of the NX Unit.
Model name	Displays the model number of the NX Unit.
Unit version	Displays the unit version of the NX Unit.
Input allocated data size [bits]	Displays the total input data size in the I/O allocation settings of the NX Unit.
Output allocated data size [bits]	Displays the total output data size in the I/O allocation settings of the NX Unit.

5-4 Setting EtherCAT Drives

● Setting EtherCAT Drives

You can set and monitor OMRON Drives (including Servo Drives/Servomotors and Inverters). Select the Servo Drive or Inverter from the EtherCAT Tab Page to set or monitor it.

The description below is related to the setup methods of MX2/RX/RX2-series Inverters. Refer to the *Sysmac Studio Drive Functions Operation Manual (Cat. No. I589)* for the setup methods and precautions for the Servo Drive.



Additional Information

The backup parameters of EtherCAT slaves are not subject to synchronization and are not downloaded to the slaves for the default settings. To transfer the backup parameters, clear the selection of the **Do not transfer Special Unit parameters and backup parameters of EtherCAT slaves (out of synchronization scope)** Check Box in the Synchronization Window before you click the **Transfer To Controller** Button.

5-4-1 Applicable EtherCAT Drives

You can set and monitor the following Drives.

Drive series	EtherCAT display	Slave models
1S Series	R88D-1SN□-ECT	R88D-1SN□-ECT
	R88D-1SN□-ECT-51	R88D-1SN□-ECT-51
	R88D-1SAN□-ECT	R88D-1SAN□-ECT
G5 Series	R88D-KN□-ECT(-L)	R88D-KN□-ECT(-L) (version 1.0 or later)
MX2 Series	3G3AX-MX2-ECT	3G3MX2-□-V1 (version 1.0 or later)
		3G3MX2-□-V2 (version 1.1 or later)
RX Series	3G3AX-RX-ECT	3G3RX-□-V1 (version 1.0 or later)
RX2 Series	3G3AX-RX2-ECT	3G3RX2-□ (version 1.0 or later)

5-4-2 Overview of the Structure of the EtherCAT Drive Tab Page

Register the EtherCAT Drive in the EtherCAT Tab Page and then right-click the Drive in the Multiview Explorer to set or monitor the Drive.

Also, the online/offline status of the Drive is displayed in the Multiview Explorer.

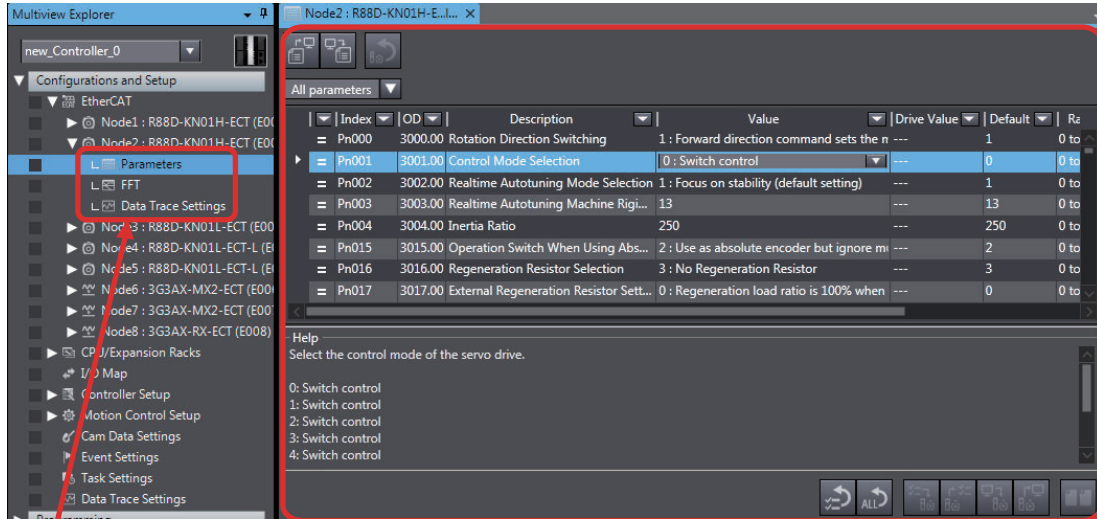

Display in the Multiview Explorer

Function Display Area (Configuration Area)

5-4-3 Setting EtherCAT Drives

Setting the Model

Set the Drive model and software number.

- 1 Double-click the Drive under **Configurations and Setup - EtherCAT** in the Multiview Explorer or right-click the Drive and select **Edit** from the menu.

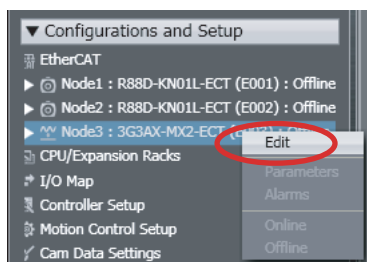

The Drive Settings Tab Page is displayed.

- 2 Click the **General** Button (📷) in the Drive Settings Tab Page.

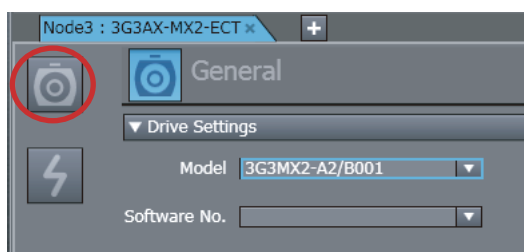

The **General** view appears in the Edit Pane.

- 3 Set the model and software number.

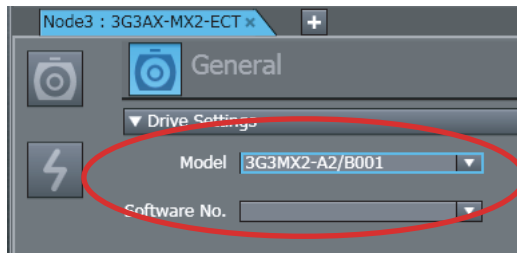

Additional Information

You can also display the Drive Settings Tab Page if you right-click the slave (3G3AX-MX2-ECT/3G3AX-RX-ECT/3G3AX-RX2-ECT) in the topology display and select **Drive Settings** from the menu.

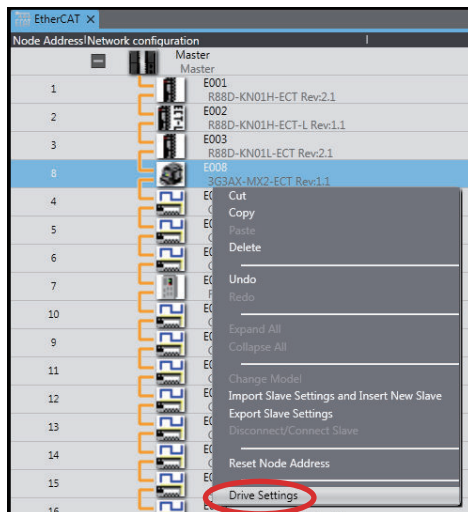

Setting the Parameters

Use the following procedure to set the Drive parameters.

- 1 Right-click the Drive under **Configurations and Setup - EtherCAT** in the Multiview Explorer and select **Parameters** from the menu.

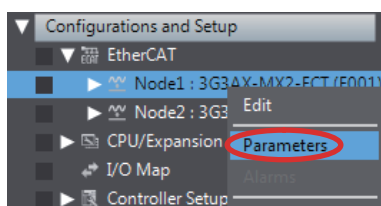





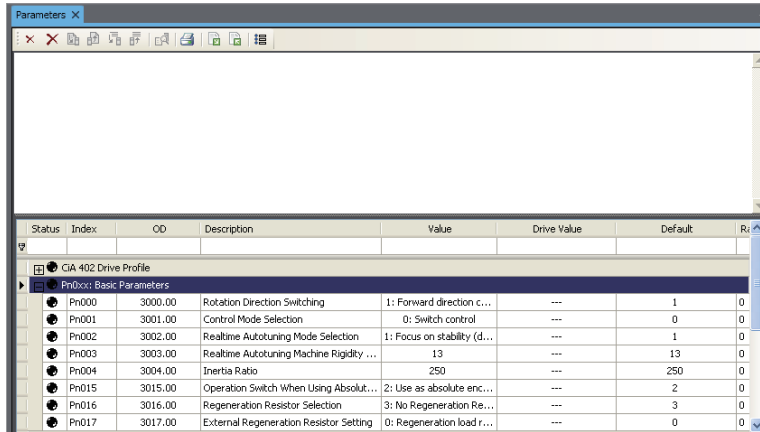



The Parameters Tab Page is displayed in the Edit Pane.

- 2 Set the axis parameters.



Toolbar in the Parameters tab page

You can perform the following operations with the buttons in the toolbar.

Button	Function
	Returns the selected parameter to the default setting.
	Returns all parameters to the default settings.
	Downloads all parameters to the Drive.
	Uploads all parameters from the Drive.
	Compares the parameters between the project and the Drive.
	Downloads the selected parameters to the Drive.
	Uploads the selected parameters from the Drive.
	Prints the parameters.
	Sets options for setting the parameters.

Going Online with a Drive

Use the following procedure to go online with a Drive.

You can use this procedure only when the Sysmac Studio is online.

- 1 Right-click the Drive under **Configurations and Setup - EtherCAT** in the Multiview Explorer and select **Online** from the menu.

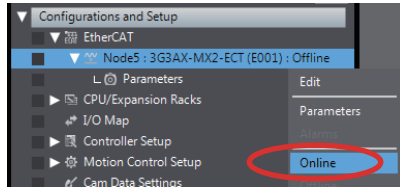

An online connection is made with the Drive.

Downloading the Parameters to the Drive

Use the following procedure to download the parameters to the Drive.
You can use this procedure only when the Sysmac Studio and Drive are online.

- 1 Click the  icon in the Toolbar on the Parameters Tab Page.

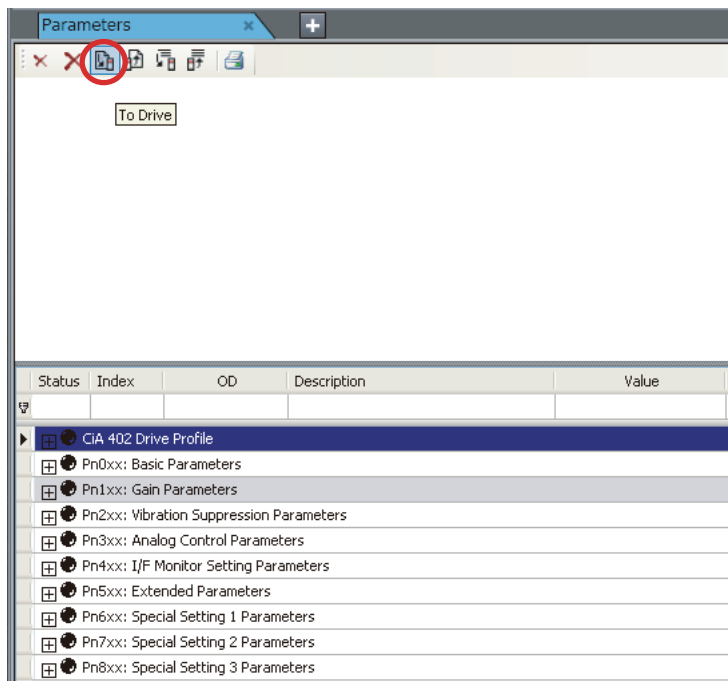

All parameters are downloaded to the Drive.



Additional Information

If you download the parameters to the Inverter in operation, the parameters will not be stored in the non-volatile memory. Note that no error will be displayed in this case. To store the parameters in the non-volatile memory, confirm that the Inverter is not in operation before you execute the download.

Comparing Drive Parameters

Use the following procedure to compare the parameters between the project and the Drive.

- 1 Click the  Button on the Parameters Tab Page.

The display of the drive values on the Parameters Tab Page are refreshed and the Comparison Results Dialog Box is displayed.

If there are no differences, click the **OK** Button. The Comparison Results Dialog Box is closed.

- 2 If parameters with differences are displayed, click the **Yes** Button in the Comparison Results Dialog Box.

The Comparison Results Dialog Box closes and only the parameters with differences are displayed.

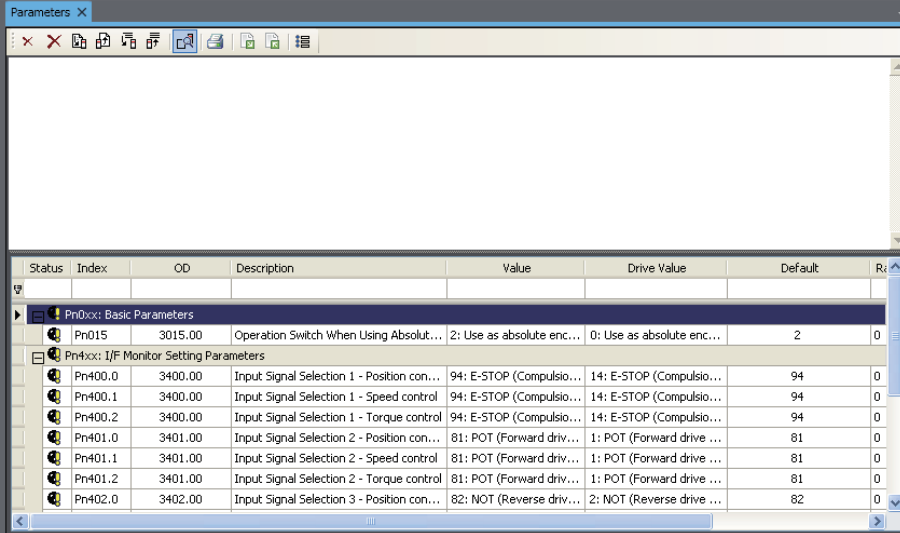

Status	Index	OD	Description	Value	Drive Value	Default	Rz
Pn0xx: Basic Parameters							
	Pn015	3015.00	Operation Switch When Using Absolut...	2: Use as absolute enc...	0: Use as absolute enc...	2	0
Pn4xx: I/F Monitor Setting Parameters							
	Pn400.0	3400.00	Input Signal Selection 1 - Position con...	94: E-STOP (Compulsio...	14: E-STOP (Compulsio...	94	0
	Pn400.1	3400.00	Input Signal Selection 1 - Speed control	94: E-STOP (Compulsio...	14: E-STOP (Compulsio...	94	0
	Pn400.2	3400.00	Input Signal Selection 1 - Torque control	94: E-STOP (Compulsio...	14: E-STOP (Compulsio...	94	0
	Pn401.0	3401.00	Input Signal Selection 2 - Position con...	81: POT (Forward driv...	1: POT (Forward drive ...	81	0
	Pn401.1	3401.00	Input Signal Selection 2 - Speed control	81: POT (Forward driv...	1: POT (Forward drive ...	81	0
	Pn401.2	3401.00	Input Signal Selection 2 - Torque control	81: POT (Forward driv...	1: POT (Forward drive ...	81	0
	Pn402.0	3402.00	Input Signal Selection 3 - Position con...	82: NOT (Reverse driv...	2: NOT (Reverse drive ...	82	0

In this status, you can transfer just the parameters with differences to the Drive or transfer them from the Drive.

If you click the **No** Button in the Comparison Results Dialog Box, all parameters are displayed and you can compare them again.

- 3 If only parameters with differences are displayed, click the Compare Button again. The Parameters Tab Page returns to the status in which you can compare the parameters again.

Option Settings

Use the following procedure to set the operation options for transferring parameters.

- 1 Click the Option Button () on the Parameters Tab Page. An **Option** Dialog Box is displayed.
- 2 Change the settings and click the **OK** Button. The settings are applied.

The option settings are listed in the following table.

Setting	Set value	Description
Transfer	Automatically transfer to drive updated parameters	Parameters that are changed online are immediately transferred to the drive.

Setting	Set value	Description
Confirmation	Confirm transfer operation	A confirmation dialog box is displayed when the button is clicked to transfer parameters.

5-4-4 Monitoring EtherCAT Drives

Displaying Drive Errors

You can display a list of errors that occurred in the Drive.

The errors are displayed only when the Sysmac Studio and Servo Drive are online.

- 1 Right-click the Drive under **Configurations and Setup - EtherCAT** in the Multiview Explorer and select **Alarms** from the menu.

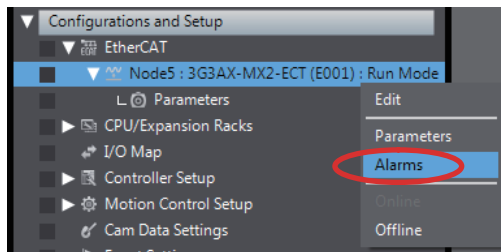

The Alarms Tab Page is displayed in the Edit Pane.

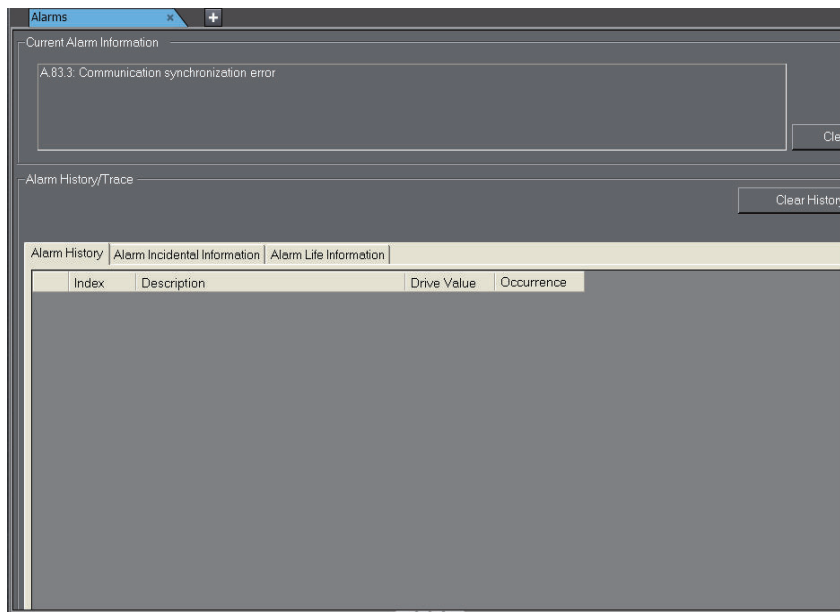

5-5 CPU/Expansion Rack Configuration and Setup

In the Sysmac Studio, you can construct a **CPU/Expansion Rack** Configuration just like you would put together with the actual physical Units.

Select **Configurations and Setup – CPU/Expansion Racks** in the Multiview Explorer to open the Edit Pane to create CPU/Expansion Racks Configuration. You can build a Rack by dragging Units from the device list displayed in the Toolbox Pane to the locations where you want to mount them.

The Units that can be mounted in the CPU/Expansion Racks depend on the CPU Unit. The following describes the configurations and setup of the CPU/Expansion Racks for the CPU Units listed below.

- NX502, NX102, or NX1P2 CPU Units
- NJ-series CPU Units

WARNING

- Check the parameters for proper execution before you use them for actual operation.
- If inappropriate parameters are set as a result of changing the event level of an NX Unit error, unexpected system operation may result. Confirm that the system will not be adversely affected before you transfer the parameters.



Precautions for Safe Use

- Always confirm safety before you reset components.
- Before you restart the EtherNet/IP Unit, make sure that doing so will not adversely affect the controlled system.



Additional Information

- For the NX701 CPU Unit and NY-series Industrial PCs, the CPU/Expansion Racks Tab Page is not displayed because there is no Unit that can be mounted on them.
- For NX-series CPU Units and NY-series Industrial PCs, you can display their production information from the Multiview Explorer. Go online with the Controller, right-click **CPU Rack** under **CPU/Expansion Racks** and select **Display Production Information**.

5-5-1 CPU/Expansion Racks for the NX502, NX102, or NX1P2 CPU Unit

The procedures to operate the CPU/Expansion Racks for the NX502, NX102 or NX1P2 CPU Unit are given below.

You can mount NX Units*¹ on an NX102 or NX1P2 CPU Unit.

You can mount X Bus Units and NX Units*¹ on an NX502 CPU Unit.

*1. There are NX Units that cannot be used with NX502, NX102, or NX1P2 CPU Units. Refer to the *NJ/NX-series CPU Unit Software User's Manual (Cat. No. W501)* for details.

In the following procedures, an NX502 CPU Unit is used as an example for the CPU/Expansion Racks for the X Bus. An NX1P2 CPU Unit is used as an example for the CPU/Expansion Racks for the NX bus.

Opening the CPU and Expansion Racks Tab Page

You can open the CPU and Expansion Racks Tab Page for the X Bus or NX bus.

● Opening the CPU and Expansion Racks Tab Page for the X Bus

- 1 Select **Configurations and Setup – CPU/Expansion Racks** and double-click **CPU Rack : X Bus** in the Multiview Explorer. Or, right-click **CPU Rack : X Bus** and select **Edit** from the menu.

The CPU and Expansion Racks Tab Page for the X Bus is displayed in the Edit Pane.

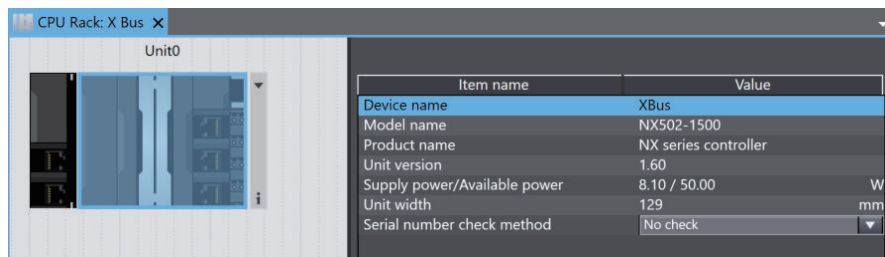

● Opening the CPU and Expansion Racks Tab Page for the NX Bus

- 1 Select **Configurations and Setup – CPU/Expansion Racks** and double-click **CPU Rack*¹** in the Multiview Explorer. Or, right-click **CPU Rack*¹** and select **Edit** from the menu.

The CPU and Expansion Racks Tab Page for the NX bus is displayed in the Edit Pane.

*1. For NX502 CPU Units, the tab title is **CPU Rack: NX Bus**.

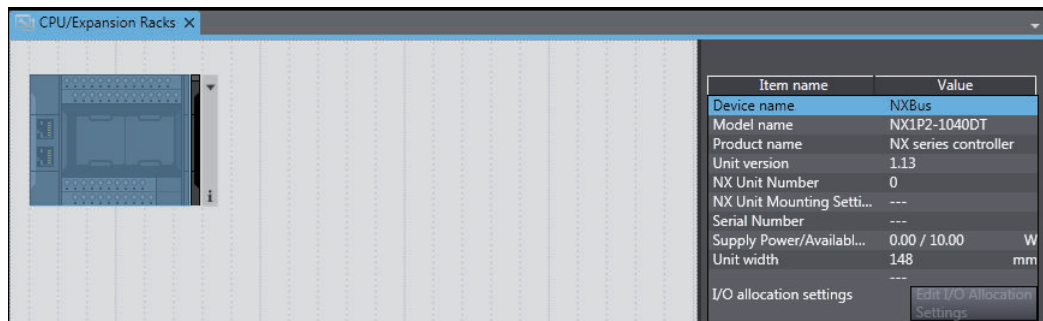

Registering X Bus Units and NX Units Offline (Building the CPU Rack Configuration)

● Registering X Bus Units and NX Units

- 1 Drag an X Bus Unit or NX Unit from the **Toolbox** to the location where you want to add it in the CPU and Expansion Racks Tab Page. Or, double-click an X Bus Unit or NX Unit.

The Unit is added.

Example for X Bus Units:

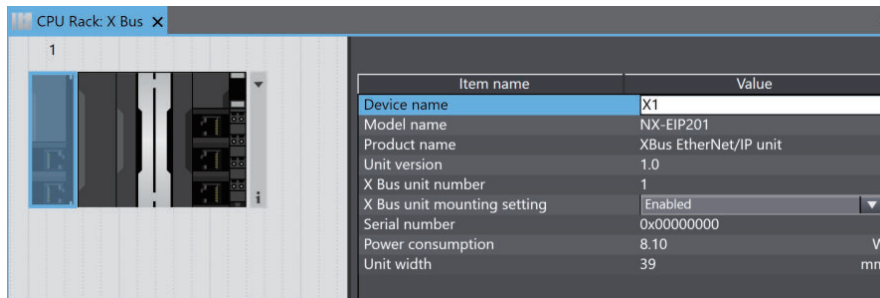

Example for NX Units:

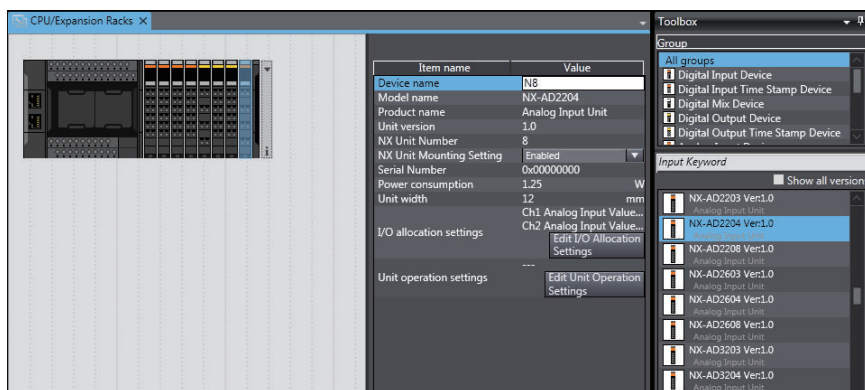

● Deleting Registered X Bus Units and NX Units

- 1 Right-click the Unit to delete and select **Delete** from the menu.
The Unit is deleted.

● Deleting All X Bus Units and NX Units

- 1 Right-click any location where there are no Units and select **Clear All** from the menu.
All of the registered Units are deleted.

● Moving X Bus Units and NX Units

- 1 Right-click the Unit to move and select **Cut** from the menu.
- 2 Right-click the location where you want to insert the Unit and select **Paste** from the menu.
The Unit is moved.



Precautions for Correct Use

If you delete an X Bus Unit or NX Unit that is assigned to an axis, the assignment to the axis is deleted. Also, if you move an X Bus Unit or NX Unit, the assignment to the axis may be deleted. If necessary, assign the Unit to the axis again.



Additional Information

You can also move the Unit by dragging it to the location where you want to insert it.

● Copying and Pasting X Bus Units and NX Units

- 1 Right-click the Unit to copy and select **Copy** from the menu.
- 2 Right-click the location where you want to insert the Unit and select **Paste** from the menu.
The copied Unit is inserted.



Additional Information

When you copy a Unit, all settings except for the device name and unit number are copied with it. The device name and unit number are automatically set to values that are not used by other Units.

Changing the Display Format for X Bus Units and NX Units

You can change how Units are displayed between the appearance diagram view and the model/Unit name view.

- 1 Right-click in the CPU and Expansion Racks Tab Page and select **Show Model/Unit Name** from the menu.
The model numbers and device names are displayed in boxes.
To restore the previous view, select **Show Model/Unit Name** again to clear the selection.

Displaying the CPU Rack Configuration Information for X Bus and NX Bus

The CPU/Expansion Rack configuration information (width and power consumption) is displayed.

- 1 Right-click **CPU/Expansion Racks** under **Configurations and Setup** in the Multiview Explorer and select **Display Composition Information**.
The width of all the Units in the CPU Rack configuration and the power consumption of each X Bus or NX bus is displayed.

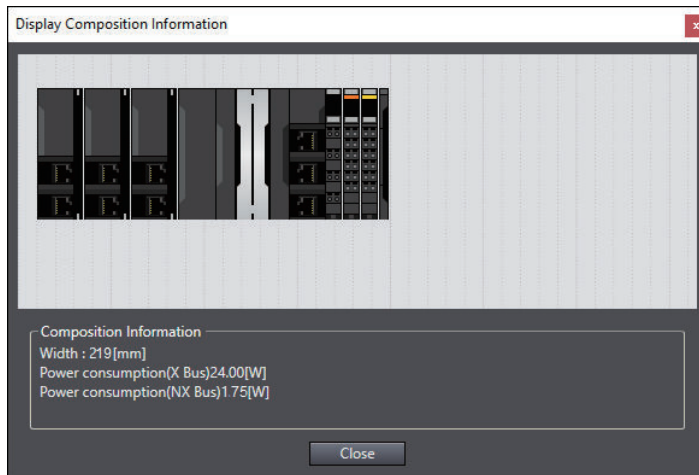

Displaying the Width of the CPU Rack Configuration

- 1 Click the  Button at the right end of the CPU Rack configuration.

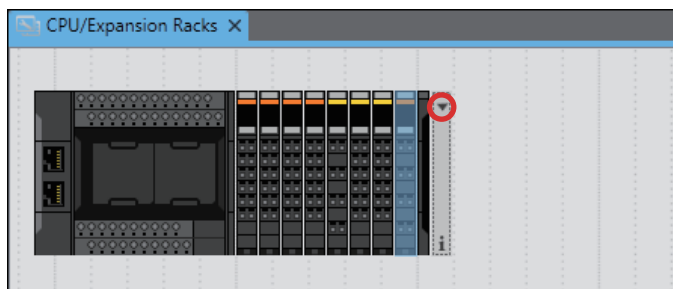

The width of the CPU Rack configuration is displayed.

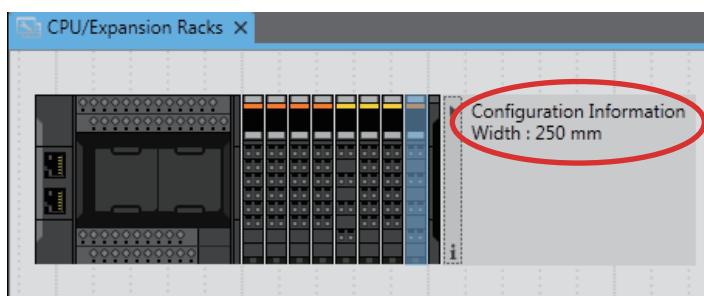

Setting X Bus Units and NX Units

The following describes the X Bus Unit and NX Unit setting items that you can configure in the CPU and Expansion Racks Tab Page.

Set the Unit parameters in the Unit setting item list.

- 1 Select the Unit to configure in the CPU and Expansion Racks Tab Page. The Unit setting item list is displayed.

Configure the I/O allocation and Unit operation settings.

Example for NX Units:

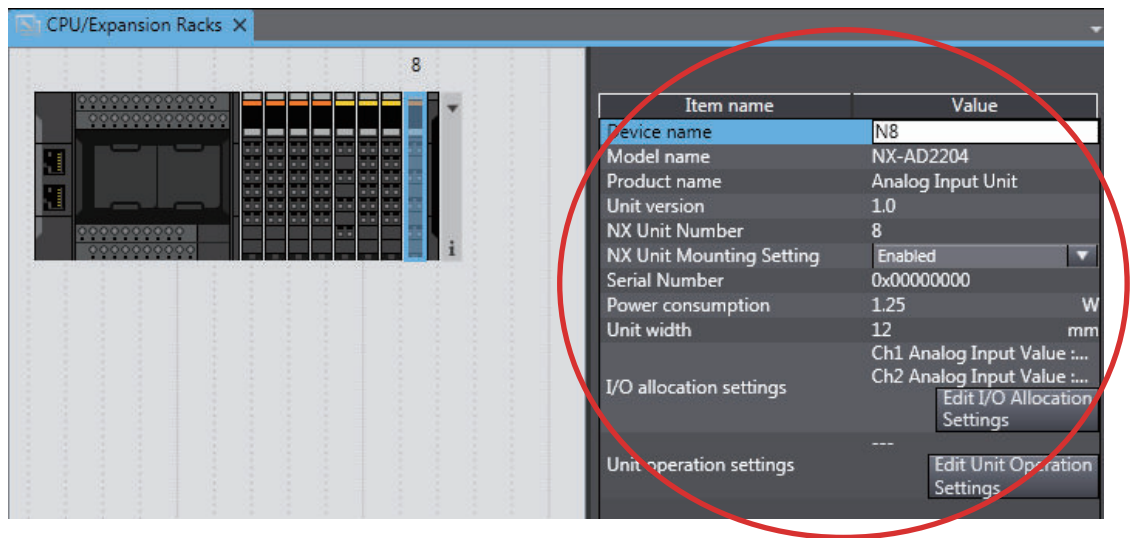

● I/O Allocation Settings

- 1 Click the **Edit I/O Allocation Settings** Button in the Unit setting item list. The I/O allocations are displayed so that you can edit them.

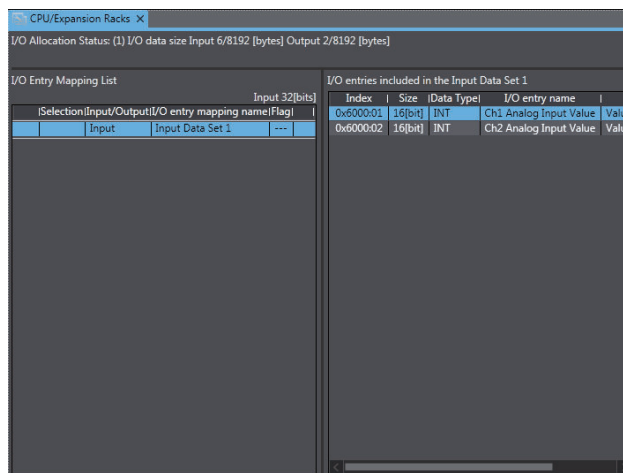

● X Bus Unit and NX Unit Mounting Settings

If you disable an X Bus Unit or NX Unit that is scheduled to be added in the future, you can continue to perform Unit settings and debugging for other Units even if the disabled Unit does not actually exist in the CPU Rack.

- 1 For X Bus Units, select **Disabled** for the **X Bus Unit Mounting Setting** parameter in the Unit setting item list. For NX Units, select **Disabled** for the **NX Unit Mounting Setting** parameter in the Unit setting item list.
An icon is displayed to show that the Unit is disabled.

Example for NX Units:

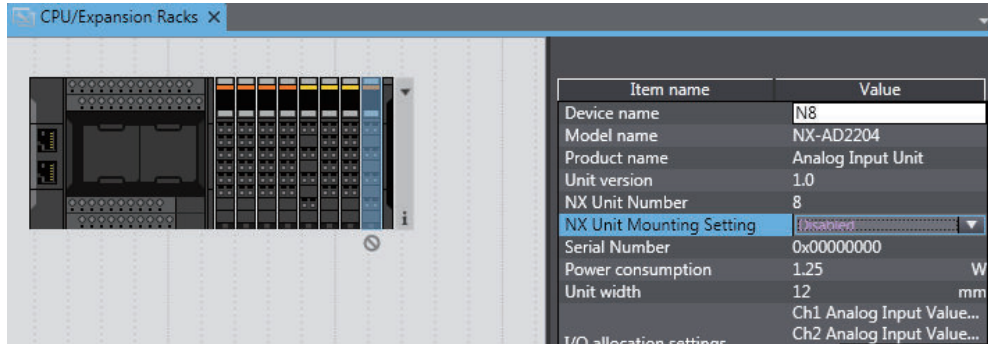

Change the setting to **Enabled** in the Unit setting item list to enable the Unit again.



Additional Information

Regardless of whether the Unit mounting setting parameter is set to Enabled or Disabled, the I/O allocation settings for the Unit are applied to the I/O data of the CPU Unit.

Operation changes as follows if the parameter is set to **Disabled**:

- If the Unit is not mounted, a Unit Configuration Verification Error does not occur, a Unit number is assigned, and the input value is locked at 0.
- If the Unit is mounted, a Unit Configuration Verification Error will occur.

● X Bus Unit EtherNet/IP Port Settings

- 1 Select **Configurations and Setup – CPU/Expansion Racks – CPU Rack: X Bus – Unit number: NX-EIP201()** and double-click **EtherNet/IP Port Settings** in the Multiview Explorer. Or, right-click **EtherNet/IP Port Settings** and select **Edit** from the menu. The EtherNet/IP Port Settings Tab Page is displayed in the Edit Pane.

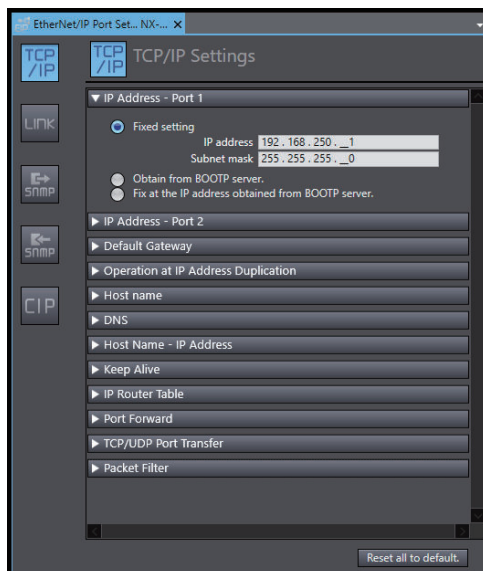

Additional Information

Refer to the *NX-series EtherNet/IP™ Unit User's Manual (Cat. No. W627)* for details on the EtherNet/IP Unit settings.

● NX Unit Operation Settings

- 1 Double-click a Unit. Or, right-click the Unit and select **Edit Unit Operation Settings** from the menu.

The Edit Unit Operation Settings Tab Page is displayed.

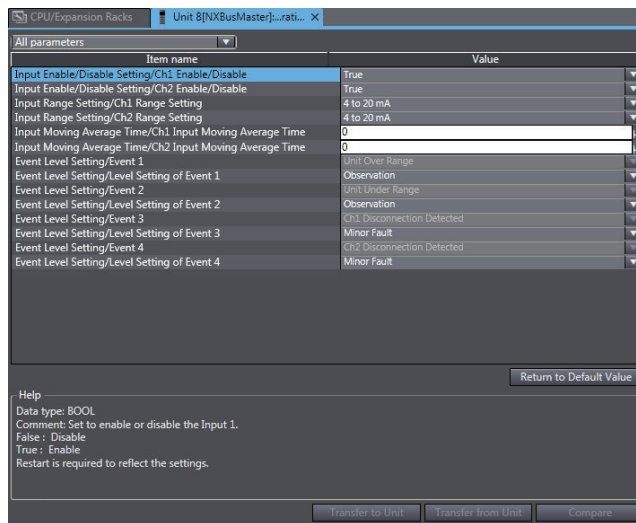

Additional Information

The specific parameters depend on the Unit. Refer to the user's manual for the specific Unit for details.

● Exporting NX Unit Settings

Use the following procedure to save the NX Unit settings in a file with an NSF file name extension.

- 1 Right-click an NX Unit in the CPU and Expansion Racks Tab Page and select **Export NX Unit Settings**.
A Save File Dialog Box is displayed.
- 2 Enter the file name, and then click the **OK** Button.
The file is saved.

● Importing NX Unit Settings to Insert a New Unit

Use the following procedure to import the settings from an NX Unit settings file with an NSF file name extension and use the settings to add a new NX Unit to the CPU Rack.

- 1 Right-click a Unit in the CPU and Expansion Racks Tab Page and select **Import NX Unit Settings and Insert New Unit**.
A Select File Dialog Box is displayed.
- 2 Select the file and then click the **OK** Button.
An NX Unit is added to the CPU Rack based on the settings in the file.

● Exporting All NX Unit Settings

Use the following procedure to save all the NX Unit settings in a file with an NSPF file name extension.

- 1 Right-click the CPU Unit in the CPU and Expansion Racks Tab Page and select **Export All NX Unit Settings**.

A Save File Dialog Box is displayed.

- 2 Enter the file name, and then click the **OK** Button.

The file is saved.

● Importing All NX Unit Settings

Use the following procedure to import all the NX Unit settings from a file with an NSPF file name extension and add newly all the NX Units included in the file.

You can import all NX Unit settings only when there is no NX Unit registered in the CPU Unit.

- 1 Right-click the CPU Unit in the CPU and Expansion Racks Tab Page and select **Import All NX Unit Settings**.

A Select File Dialog Box is displayed. An error message is displayed if there is any NX Unit. In this case, delete all the registered NX Units and select **Import All NX Unit Settings** again.

- 2 Select the file and then click the **OK** Button.

All the NX Units included in the file are added to the CPU Unit.

Changing the Model of X Bus Units and NX Units

The following procedure shows how to change the model or unit version of a registered X Bus Unit or NX Unit.

- 1 Right-click the Unit for which to change the model in the CPU and Expansion Racks Tab Page and select **Change Model** from the menu.

The Units that you can change to are displayed in the Change Model Dialog Box.

- 2 Select the Unit to change to and then click the **OK** Button.

The Unit is changed to the selected model and unit version.



Precautions for Safe Use

Check the user program, data, and parameter settings for proper execution before you use them for actual operation.



Precautions for Correct Use

- If you change the model of an NX Unit that is assigned to an axis, the assignment to the axis is deleted. If necessary, assign the NX Unit to the axis again.
- If a replaced X Bus Unit/NX Unit does not support the setting values of an original unit, the values will be lost after changing the model.
- Note that If the performance of a replaced X Bus Unit/NX Unit is not the same as the previous unit, the I/O timing may change.

Registering X Bus Units and NX Units Online (Building the CPU Rack Configuration)

Use the following procedure to automatically create the configuration in the Sysmac Studio from the actual CPU Rack configuration.

- 1 Go online, right-click in the CPU and Expansion Racks Tab Page, and select **Compare and Merge with Actual Unit Configuration**.
The actual Unit configuration is read and compared with the Unit configuration in the Sysmac Studio. The results are displayed in the **Compare and Merge with Actual Unit Configuration** Dialog Box.

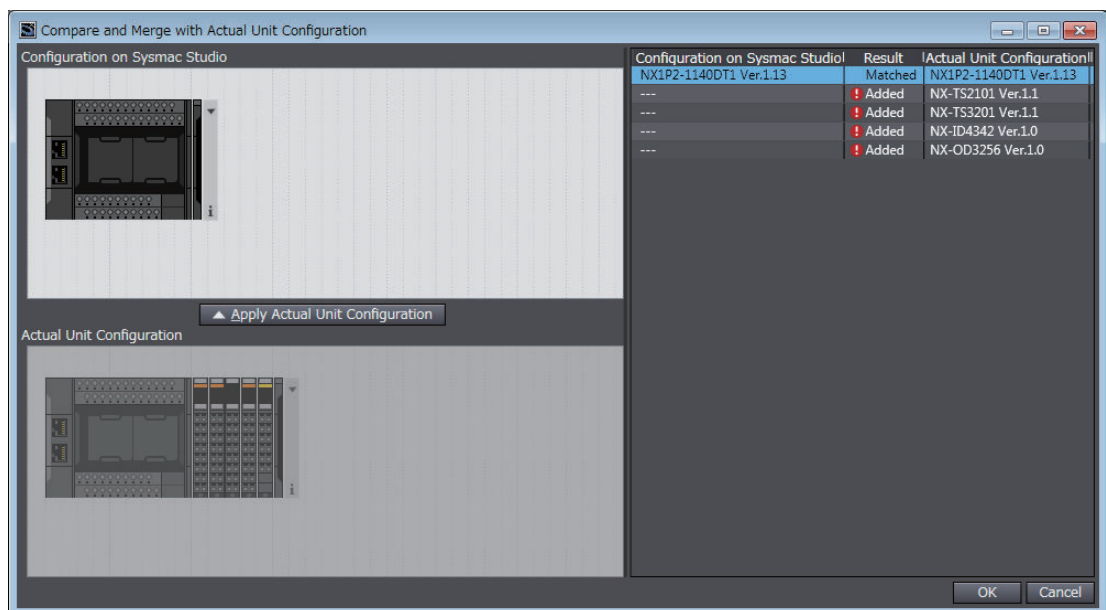

- 2 Click the **Apply actual Unit configuration** Button to synchronize the Unit configuration in the Sysmac Studio with the actual Unit configuration.
- 3 Click the **OK** Button.
The CPU and Expansion Racks Tab Page is displayed again.



Precautions for Safe Use

Check the user program, data, and parameter settings for proper execution before you use them for actual operation.



Precautions for Correct Use

- If you automatically create the CPU Rack configuration in the Sysmac Studio by clicking the **Apply actual Unit configuration** Button, any previously set CPU Rack configuration and NX Unit settings are discarded.
To merge the CPU Rack information without losing the current settings in the Sysmac Studio, do not use the **Apply actual Unit configuration** Button, and use the compare and merge operation to create the configuration. Refer to *7-5-1 Transferring/Comparing Data to/from the Controller* on page 7-127 for information on the operation to compare and merge with the actual network configuration in the Sysmac Studio.
- When the compare and merge operation is performed for the actual Unit configuration, the synchronization between the Sysmac Studio and the Controller is lost. Synchronize the Sysmac Studio and Controller before you perform any online operations for the CPU Rack. Refer to *7-5-1 Transferring/Comparing Data to/from the Controller* on page 7-127 for information on synchronization.
- If an X Bus Unit or NX Unit that is assigned to an axis is deleted as the result of **Compare and Merge with Actual Unit Configuration** operation, the assignment to the axis is also deleted. If necessary, assign the Unit to the axis again.

● Reading Serial Numbers

The serial numbers can be read from the Units in the actual Unit configuration and applied to the CPU configuration in the Sysmac Studio.

- 1 Go online, right-click in the CPU and Expansion Racks Tab Page. For X Bus Units, select **Get Serial Numbers of All X Bus Units**. For NX Units, select **Get Serial Numbers of All NX Units**.

The Get Serial Numbers of All NX Units Dialog Box is displayed.

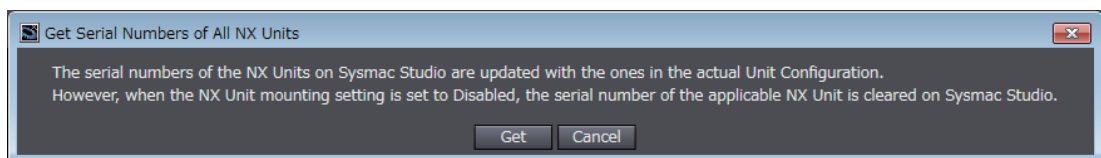

- 2 Click the **Get** Button.

The serial numbers are read from the Units in the actual Unit configuration and applied to the Units in the CPU Rack on the Sysmac Studio.



Additional Information

If the Unit mounting setting parameter is set to **Disabled**, the serial number of the Unit is cleared to 0.

Transferring the CPU/Expansion Rack Configuration Information

Use the synchronize operation to transfer the CPU/Expansion Rack configuration information. Refer to *Synchronizing (Uploading/Downloading after Automatic Verification)* on page 7-127 for details on synchronization.

- 1 Go online and select **Synchronization** from the **Controller** Menu.
The Synchronization Window is displayed.

- 2 Select the **CPU/Expansion Racks** Check Box in the Synchronization Window and then click the **Transfer To Controller** Button.

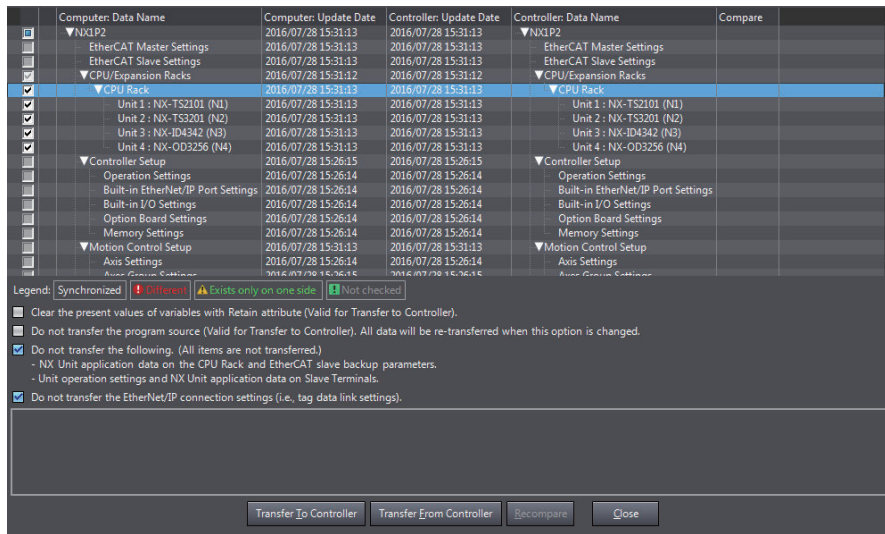

The CPU Rack configuration information is downloaded from the Sysmac Studio to the Controller.

5-5-2 CPU Rack and Expansion Racks for NJ-series CPU Units

The procedures to operate the CPU Rack and Expansion Racks for NJ-series CPU Units are given below.

You can mount CJ-series Units on an NJ-series CPU Unit.

Opening and Using the Unit Editor

- 1 Double-click **CPU/Expansion Racks** under **Configurations and Setup** in the Multiview Explorer. Or, right-click **CPU/Expansion Racks** under **Configurations and Setup** and select **Edit** from the menu.

The Unit Editor is displayed in the Edit Pane.

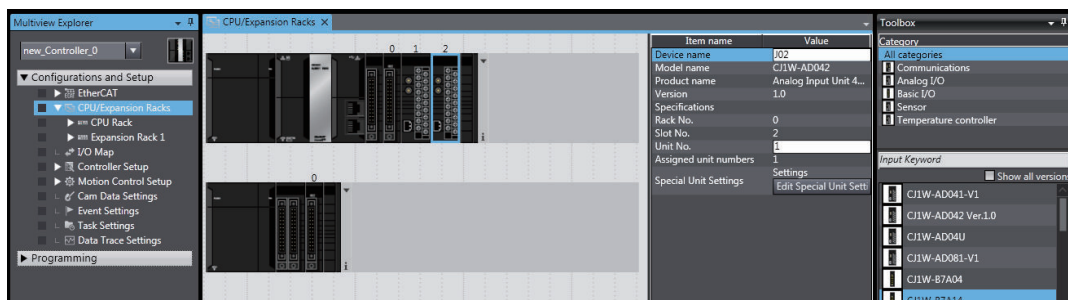

Unit Information	Displays device information for the selected Unit, such as the device name, model number, rack number, slot number, unit number, number of unit numbers assigned, response time, and error information.
Rack Information	Click the tab to the right of a Rack to view its power consumption and size.

Registering Units Offline to Create the Unit Configuration

● Procedure to Add Units

- 1** Drag the Unit selected in the Model Selection Pane to the Unit Editor. Or, double-click the Unit. The Unit is added.
- 2** If you add a Special Unit, set the unit number.

● Procedure to Delete Units

- 1** Right-click the Unit to delete and select **Delete** from the menu.
- 2** The Unit is deleted.

● Procedure to Move Units

- 1** Right-click the Unit to move and select **Cut** from the menu.
- 2** Right-click at the location where you want to insert the Unit and select **Paste** from the menu. The result is that the Unit is moved.



Additional Information

You can also move the Unit by dragging it to the location where you want to insert it.

● Procedure to Copy and Paste Units

- 1** Right-click the Unit to copy and select **Copy** from the menu.
- 2** Right-click at the location where you want to insert the Unit and select **Paste** from the menu. The Unit is pasted.



Additional Information

When you copy a Unit, all settings except for the device name and unit number (for a Special Unit) are copied with it. The device name and unit number (for a Special Unit) are automatically set to values that are not used by other Units. Each Rack can contain a maximum of 10 Units.

● Procedure to Change the Unit

- 1** Right-click the Unit and select **Change Model** from the menu. The Change Model Dialog Box is displayed.
- 2** Select the Unit and then click the **OK** Button. The Unit is changed to the selected model.

● Procedure to Change the Power Supply Unit Model

- 1 Right-click the Power Supply Unit and select **Change Model** from the menu.
The Change Model Dialog Box is displayed.
- 2 Select the Power Supply Unit, and then click the **OK** Button.

Creating Racks

● Procedure to Add Racks

- 1 Right-click at any location where there are no Units and select **Add Rack** from the menu.
The Rack is added.

● Procedure to Delete Racks

- 1 Select a Unit of the Rack to delete.
- 2 Right-click at any location where there are no Units and select **Delete Rack** from the menu.
The Rack is deleted.

● Procedure to Delete All Racks and Units

- 1 Right-click at any location where there are no Units and select **Clear All** from the menu.
All Racks and Units are deleted.

Changing How Units Are Displayed

Right-click at any location where there are no Units and select **Show Model/Unit Name** from the menu.

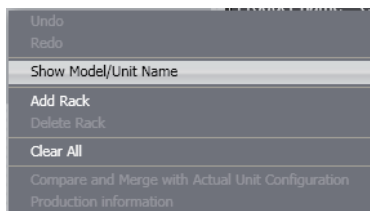

The unit numbers, model names, and device names are displayed.

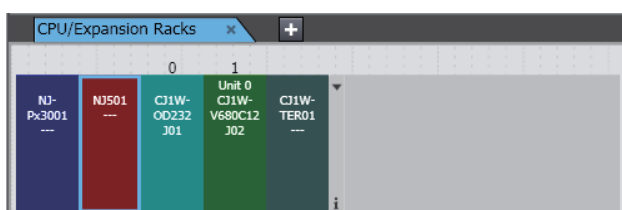

Displaying Rack Widths, Current Consumptions, and Power Consumptions

- 1 Click  Button at the right end of a Rack.



The rack width, current consumption, and power consumption are displayed.

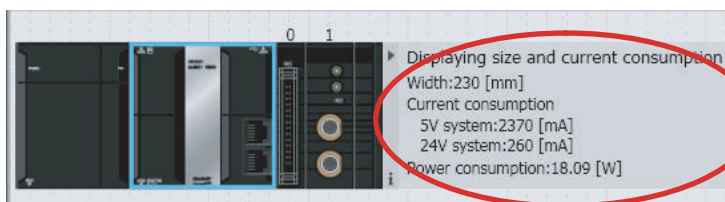

Setting Basic Input Units

● Editing the Settings of Basic Input Units

You can set the input response time of a Basic Input Unit in the Unit Information in the Unit Editor.

Setting Special Units

● Procedure to Edit the Special Unit Setup

- 1 Double-click a Unit. Or, right-click the Unit and select **Edit Special Unit Settings** from the menu.

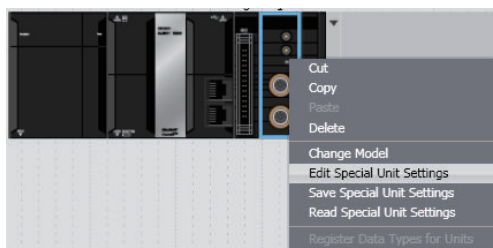

The **Edit Special Unit Settings** Tab Page for the selected Unit is displayed.

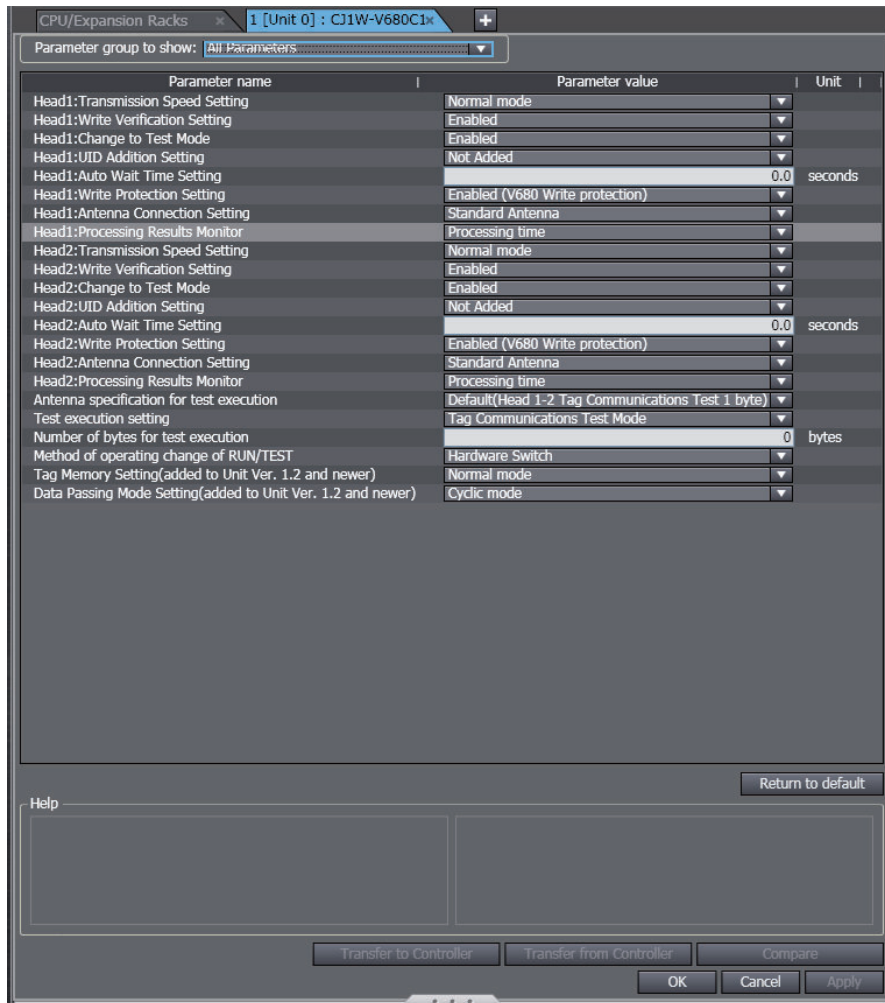

- 2 Edit the parameters, and then click the **OK** Button.



Additional Information

Default settings are defined for each Special Unit. Items with set values that are different from the default values are displayed in a different color so that you can distinguish them. You can click the **Return to default** Button to restore all set values that have changed on the Sysmac Studio to the default values.



Precautions for Correct Use

No checks are made to verify the logical consistency between data items in the Special Unit Setup. Therefore, always check the logical consistency between all settings before transferring the Special Unit Setup to the Controller and starting operation, especially when you perform tasks such as enabling or disabling a setting from another setting. Depending on the settings, logical inconsistencies could result in unintended operation.

For example, assume that setting item 1 specifies either *defaults* or *user settings* and that the user settings start from setting item 2. Here, even if you set the user settings from item 2 onward, the *setting* of setting item 1 will not be automatically changed to specify using the *user settings*. In this case, if you do not also change the *setting* of setting item 1 to specify using the *user settings*, the settings from items 2 onward will be ignored.

The settings for the Special Units in the CPU Unit are not restored to the default settings as soon as you click the **Return to default** Button.

● Procedure to Save the Special Unit Settings

- 1 Right-click a Unit and select **Save Special Unit Settings** from the menu.

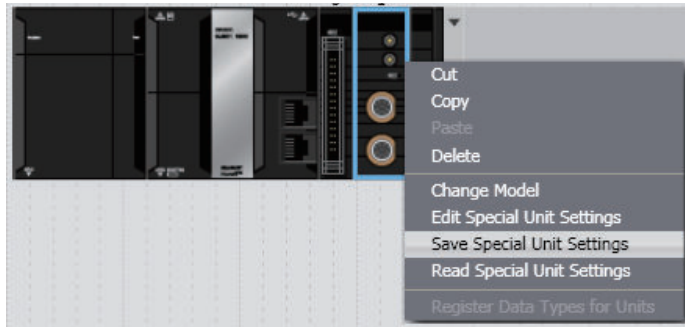

A **Save File** Dialog Box is displayed.

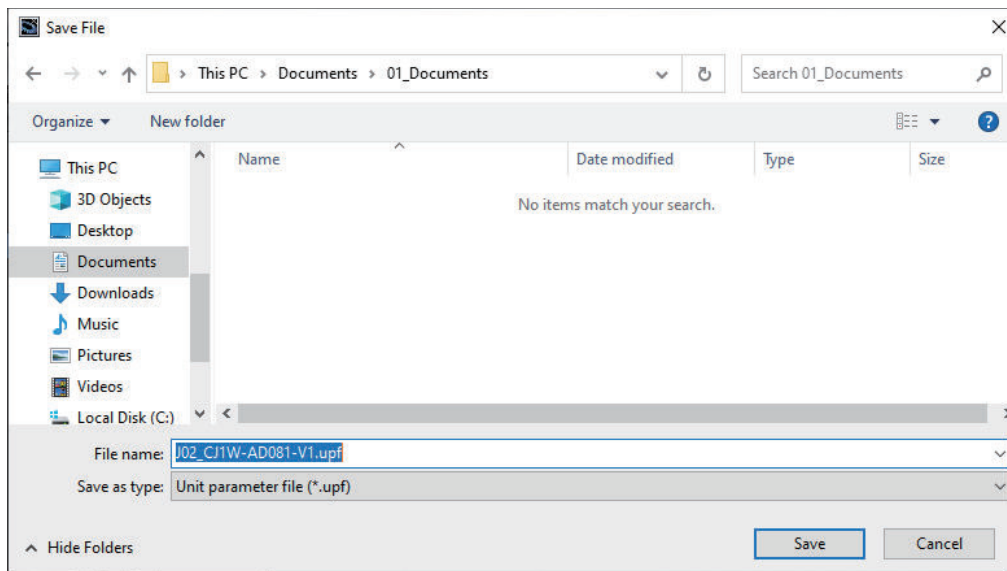

- 2 Enter a file name, and then click the **Save** Button.

A Unit parameter file is saved with a .upf or .upf2*1 extension.

*1. The extension is .upf2 if you are exporting Unit settings for a CJ-series EtherNet/IP Unit that is mounted on an NJ-series CPU Unit version 1.60 or later.



Additional Information

All settings except for the device name and unit number are saved in the Unit parameter file.

● Procedure to Read Special Unit Setting File

- 1 Right-click a Unit and select **Read Special Unit Settings** from the menu.

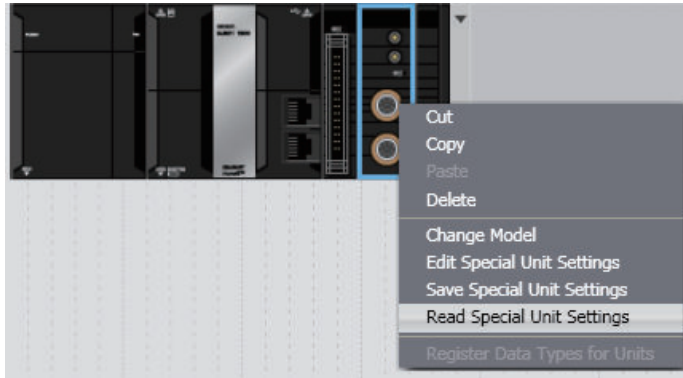

A **Open File** Dialog Box is displayed.

- 2 Select the Unit parameter file with a .upf or .upf2*¹ extension that you saved, and then click the **Open** Button.

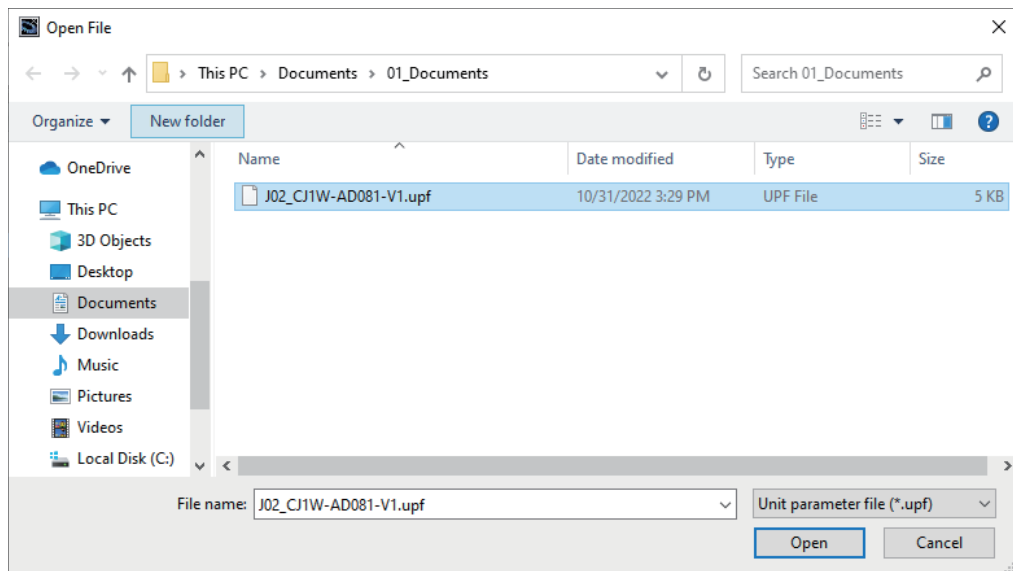

The parameters are read from the file.

*1. Unit parameter files with a .upf2 extension can be loaded when the project's Controller is an NJ-series CPU Unit version 1.60 or later.



Additional Information

- All settings except for the device name and unit number are saved in the Unit parameter file.
- You can import the unit parameter file for the CJ1W-EIP21 that you exported according to *Procedure to Save the Special Unit Settings* on page 5-60 above into the CJ1W-EIP21S. Any differences in data between the CJ1W-EIP21 and CJ1W-EIP21S will be converted before import. Refer to the *CJ-series EtherNet/IP Units Operation Manual for NJ-series CPU Unit (Cat. No. W495)* for details on replacing the CJ1W-EIP21 with the CJ1W-EIP21S.

Registering Units Online to Configure the CPU Rack and Expansion Racks

- **Procedure to Automatically Create the Configuration on the Sysmac Studio from the Actual Unit Configuration**

- 1 Go online, right-click anywhere in the Unit Editor where there is no Unit and select **Compare and Merge with Actual Unit Configuration**.

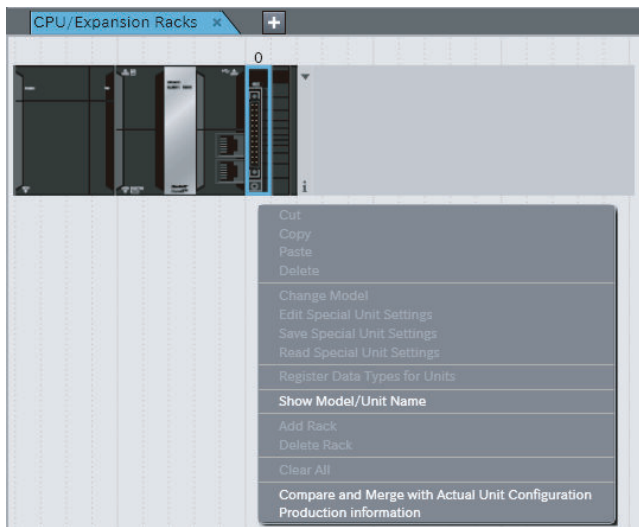

The actual Unit configuration is read and compared with the Unit configuration on the Sysmac Studio. The results are displayed in the **Compare and Merge with Actual Unit Configuration** Dialog Box.

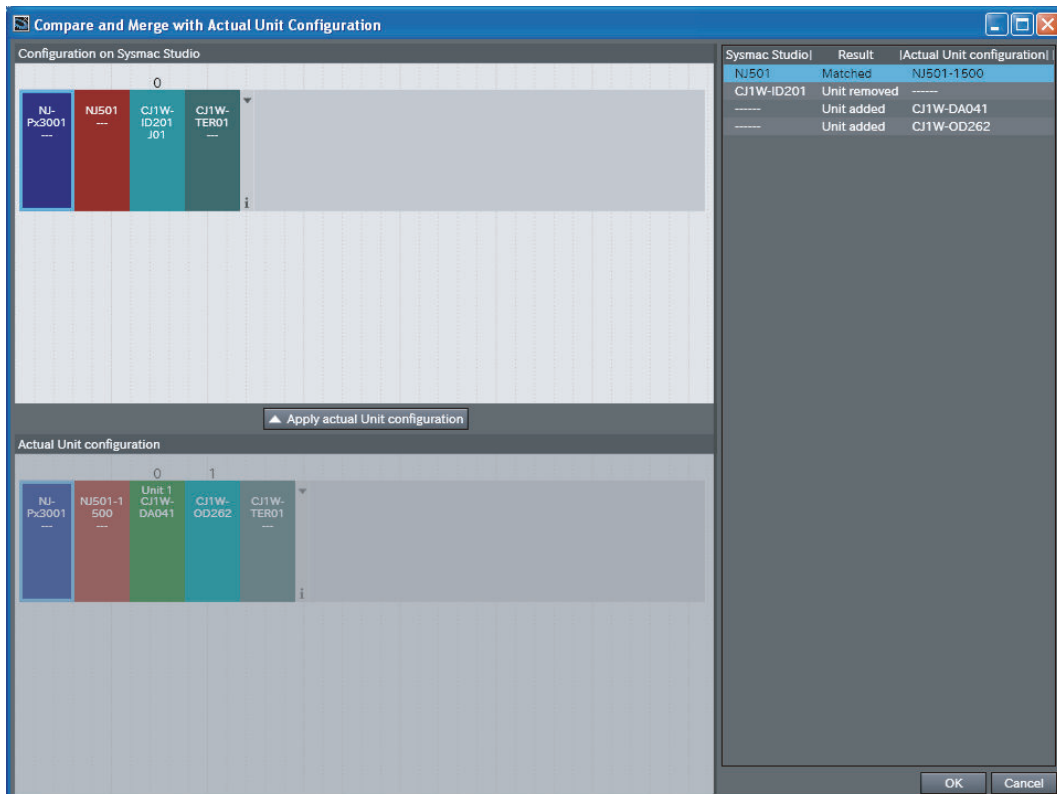

- 2 Click the **Apply actual Unit configuration** Button to synchronize with the actual Unit configuration.
- 3 Click the **OK** Button.
This returns you to the Unit Editor.

Transferring the CPU/Expansion Rack Configuration Information

Use the synchronize operation to transfer the CPU/Expansion Rack configuration information. Refer to *Synchronizing (Uploading/Downloading after Automatic Verification)* on page 7-127 for more information on synchronizing.

- 1 Go online and select **Synchronization** from the **Controller** Menu.

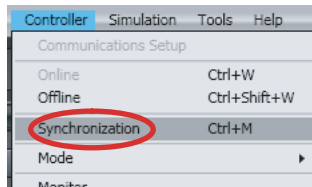

The Synchronization Window is displayed.

- 2 Select the **CPU/Expansion Racks** Check Box in the Synchronization Window and then click the **Transfer To Controller** Button.

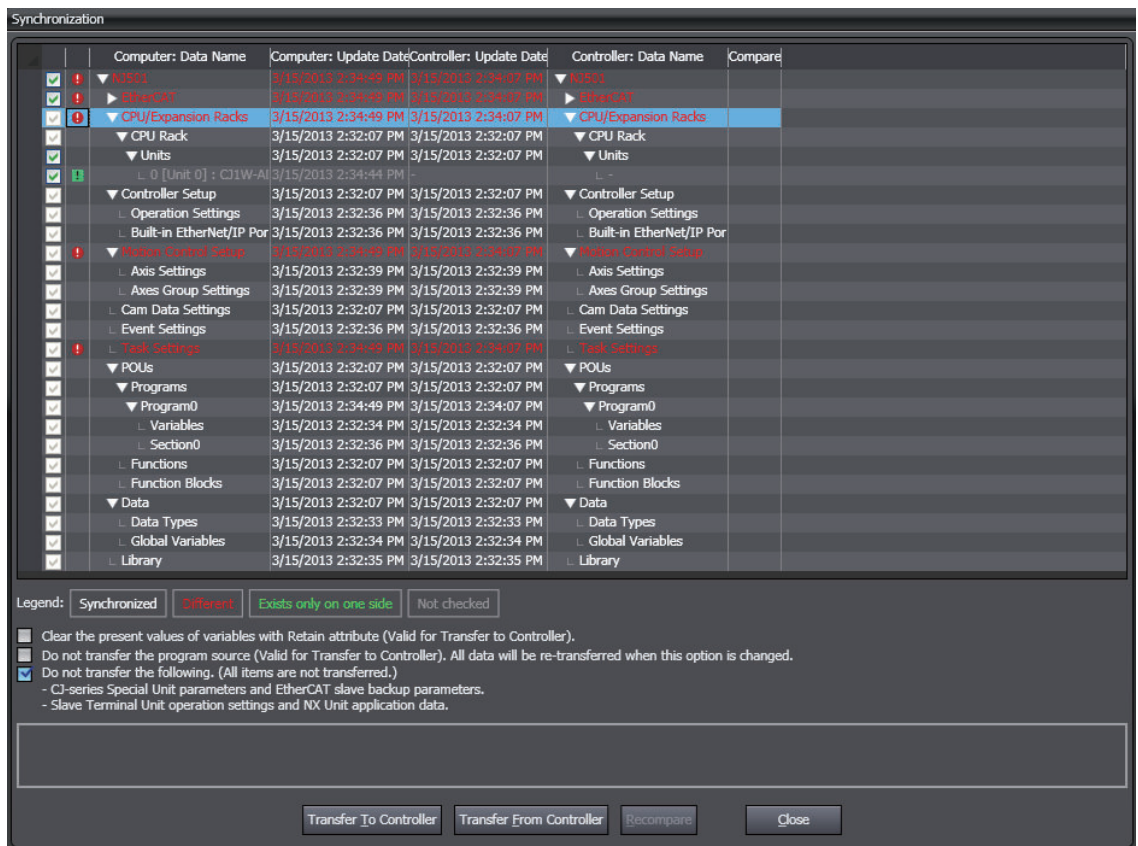

The CPU/Expansion Racks configuration information is downloaded from the Sysmac Studio to the Controller.



Additional Information

The parameters of the Special Units in the configuration information for the CPU/Expansion Racks are not subject to synchronization and are not downloaded to the CPU Unit for the default settings. To transfer the parameters of the Special Units in the configuration information for the CPU/Expansion Racks, clear the selection of the **Do not transfer the following. (All items are not transferred.) -CJ-series Special Unit parameters and EtherCAT slave backup parameters.** Check Box and select the check box for the CPU Rack and Expansion Racks in the Synchronization Window before you click the **Transfer To Controller** Button.

5-6 Controller Setup

Use the Controller Setup to change settings related to the operation of the Controller.

The Controller Setup contains PLC Function Module operation settings and built-in EtherNet/IP Function Module port settings.

Note that specific settings are required depending on the Controller.

5-6-1 Operation Settings

- Operation Settings

These settings are related to the operation of the PLC Function Module, such as the *Startup Mode*, the routing tables, and the event levels of Controller errors. There are basic settings, FINS settings, and event level settings.

The settable items vary with the Controller. Refer to the manuals for the specific Controllers for details.

- Procedure to Open the Operation Settings Tab Page

- 1 Double-click **Operation Settings** under **Configurations and Setup - Controller Setup** in the Multiview Explorer. Or, right-click Operation Settings and select **Edit** from the menu.

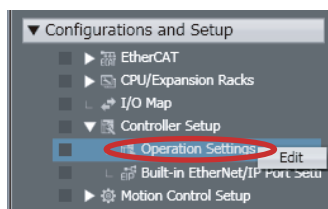

The **Operation Setting** Tab Page is displayed in the Edit Pane.

- Procedure to Open the Basic Settings View

- 1 Double-click **Operation Settings** under **Configurations and Setup - Controller Setup** in the Multiview Explorer. Or right-click Operation Settings and select **Edit** from the menu.
The **Basic Settings** view is displayed on the Operation Settings Tab Page in the Edit Pane.
- 2 If the **Basic Settings** view does not appear, click the **Basic Settings** Button (🔍).

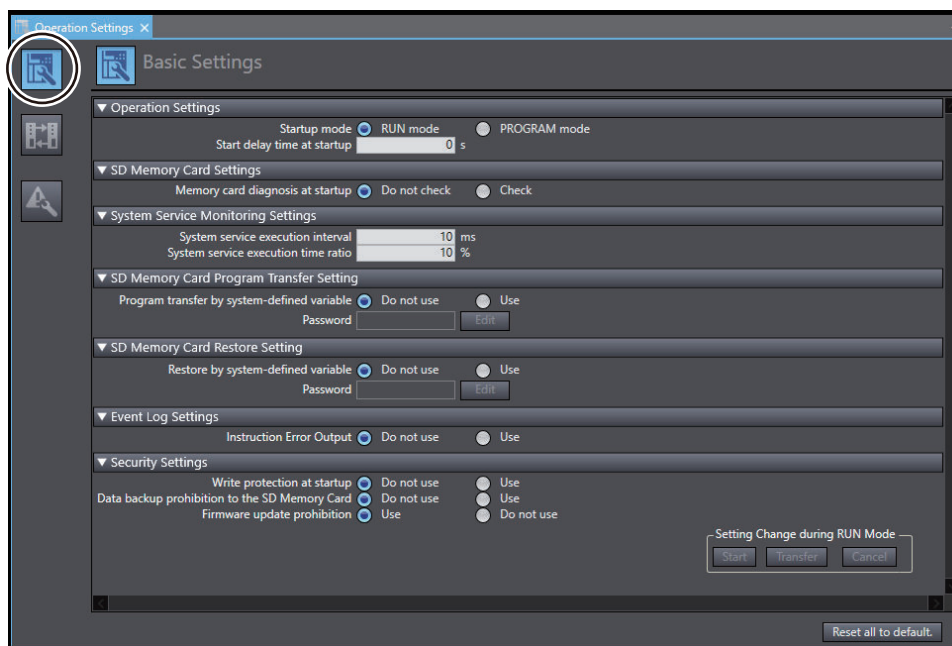

The basic settings are listed below.

Basic Settings

Category	Setting	Description
Operation Settings	Startup Mode	Sets the operating mode to enter when the power is turned ON.
	Start delay time at startup* ¹	Sets the time to wait for an NS-series PT to perform the tag verifications with priority during startup after the power supply is turned ON.
	Battery-related error detection* ²	Sets whether to perform battery-related error detection.
SD Memory Card Settings* ³	Memory Card Diagnosis at Startup	Sets whether to execute self-diagnosis (file system check and restoration) on the inserted SD Memory Card when the power is turned ON.
Virtual SD Memory Card Settings* ⁴	Virtual SD Memory Card	Sets whether to use the shared folder as a Virtual SD Memory Card.
	Computer name	Sets the Windows computer name.
	IP address	Sets the IP address of the Windows internal port.
	Shared folder name	Sets a shared folder name used as a Virtual SD Memory Card.
	User name	Sets a shared user name to use the shared folder as a Virtual SD Memory Card.
System Service Monitoring Settings* ⁵	Password	Sets a password to access the shared folder as a Virtual SD Memory Card.
	System service execution interval [ms]	Sets the interval to monitor system service execution.
	System service execution time ratio [%]	Sets the ratio to monitor execution of system services in relation to overall processing of the CPU Unit.

Category	Setting	Description
SD Memory Card Program Transfer Setting ^{*3*6}	Program transfer by systemdefined variable	Enables or disables the program transfer from the SD Memory Card.
	Password	Sets the password that is used for verification when you execute the program transfer from the SD Memory Card. Valid number of characters: 8 to 32 Valid type of characters: Single-byte alphanumeric characters (case sensitive)
SD Memory Card Restore Setting ^{*3*7}	Restore by system-defined variable	Enables or disables the restore of data from the SD Memory Card.
	Password	Sets the password that is used for verification when you execute the restore of data from the SD Memory Card. Valid number of characters: 8 to 32 Valid type of characters: Single-byte alphanumeric characters (case sensitive)
Shutdown Wait Time Setting ^{*4}	User Program	Sets the time spent waiting for the start of shutdown processing on the Controller after a backup signal output from the UPS turns ON or a shutdown instruction is given by the power supply button.
	OS	Sets the time spent waiting for the detection of shutdown completion on the Windows after a shutdown instruction is given by the Controller to the Windows.
Event Log Settings ^{*8}	Instruction Error Output	Sets whether to output instruction errors to a Controller event log when an error occurs in an instruction. Refer to <i>8-16 Troubleshooting</i> on page 8-120 for information on the event logs.
Security Settings	Write Protection at Startup	Sets whether to write-protect the CPU Unit when the power supply is turned ON.
	Data backup prohibition to the SD Memory Card ^{*9}	Sets whether to enable or disable SD Memory Card backups.
	Firmware update prohibition ^{*10*11}	Sets whether to enable or disable firmware updates.
Setting Change during RUN Mode	<ul style="list-style-type: none"> Start Transfer Cancel 	As long as the parameters match between the project and the Controller, you can write the following settings during RUN mode. <ul style="list-style-type: none"> Write protection at startup Disabling backups to SD Memory Cards Refer to <i>8-3-5 Write Protection of the CPU Unit</i> on page 8-37 for details on write protection.
---	Reset all to default.	Returns all of the basic settings and FINS settings to their default settings.

*1. This setting is supported by CPU Units with unit version 1.10 or later.

*2. This is displayed only for an NX502, NX102, or NX1P2 Controller.

*3. This is not displayed for an NY-series Controller.

*4. This is displayed only for an NY-series Controller.

*5. This is displayed only for an NJ-series CPU Unit.

*6. This setting is supported by NJ/NX-series CPU Units with unit version 1.11 or later.

*7. This setting is supported by NJ/NX-series CPU Units with unit version 1.14 or later.

- *8. This setting is supported by CPU Units with unit version 1.02 or later.
- *9. This setting is supported by CPU Units with unit version 1.03 or later.
- *10. Firmware update prohibition is displayed only for the following Controllers.
 - NJ-series, NX502, NX102, or NX1P2 CPU Unit: Version 1.60 or later
 - NX701 CPU Unit: Version 1.32 or later
- *11. For details on firmware updates, please contact OMRON sales representatives.

For details on the settings, refer to the *NJ/NX-series CPU Unit Software User's Manual (Cat. No. W501)* or *NY-series Industrial Panel PC / Industrial Box PC Software User's Manual (Cat. No. W558)*.



Precautions for Correct Use

You cannot undo or redo operations in the Basic Settings view.



Additional Information

If there is a mistake in any set value, it is highlighted in red. Move your mouse over any location for which an error is displayed to view the error message as a tooltip.

● Procedure to Open the FINS Settings View

You can use FINS networks and FINS communications with NX502, NX102, or NX1P2 Controller and NJ-series Controllers.

- 1** Double-click **Operation Settings** under **Configurations and Setup - Controller Setup** in the Multiview Explorer. Or right-click Operation Settings and select **Edit** from the menu. The **Basic Settings** view is displayed on the Operation Setting Tab Page in the Edit Pane.
- 2** Click the **FINS Settings** Button () displayed on the Operation Settings Tab Page in the Edit Pane.

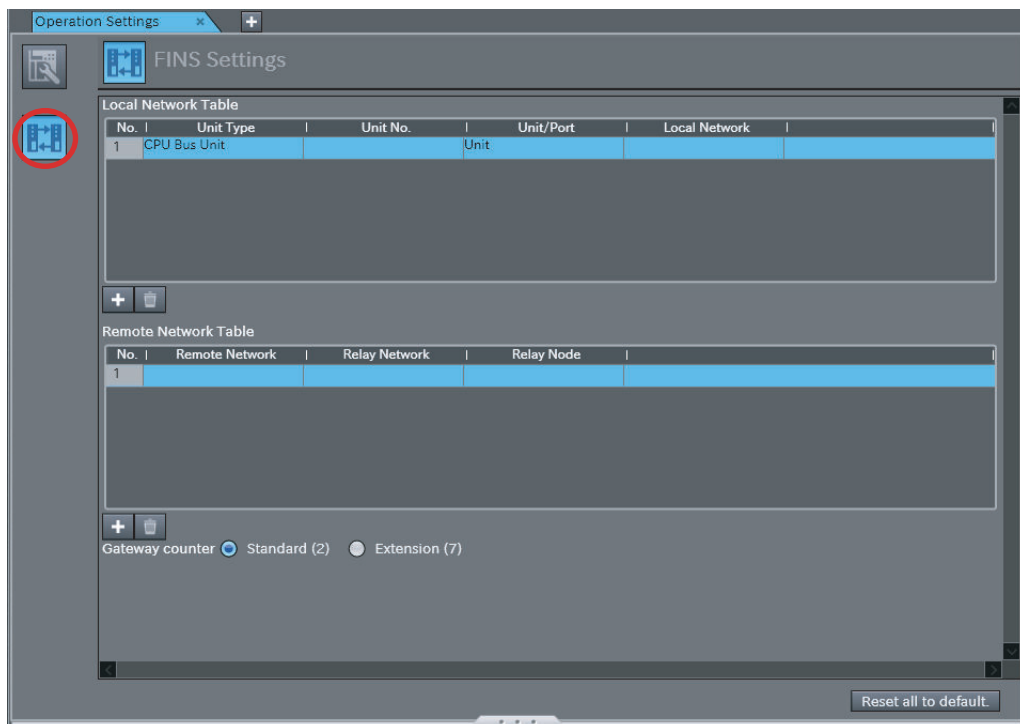

The **FINS Settings** view is displayed.

FINS Settings

Setting	Item or set value	Default	Description	
Local Network Table	Unit type	<ul style="list-style-type: none"> CPU Bus Unit*¹ Special I/O Unit*¹ Built-in EtherNet/IP port 	CPU Bus Unit* ¹	Select the Unit type.
	Unit number	<ul style="list-style-type: none"> CPU Bus Unit: 0 to 15 Special I/O Unit: 0 to 95 Built-in EtherNet/IP port: 250 	---* ²	If the Unit is a <i>CPU Bus Unit</i> or <i>Special I/O Unit</i> , set the unit number.
	Unit/Port	<ul style="list-style-type: none"> Unit Port 1 Port 2 	Unit* ³	If the Unit is a <i>CPU Bus Unit</i> , specify the Unit or port that connects to the network.
	Local network	1 to 127	---	Set the local network number.
Remote Network Table	Remote network	1 to 127	---	Set the number of the network to connect to.
	Relay network	1 to 127	---	Set the number of the relay network closest to the local network.
	Relay node	1 to 254	---	Set the node number that is connected to the relay network from the local network.
Gateway counter	Standard (2) or Extension (7)	Standard (2)	Set the GCT (gateway counter), which determines how many levels of the network to go through when a FINS command or FINS response is sent. Standard: Up to 3 levels (GCT = 02 hex) Extension: 4 to 8 levels (GCT = 07 hex)	
---	Reset all to default.	---	The Reset all to default Button resets all the settings to their default values.	

*1. Displayed only with the NJ-series CPU Unit.

*2. If the Unit is the built-in EtherNet/IP port, this value is always 250.

*3. If the Unit is a Special I/O Unit or built-in EtherNet/IP port, this value is always *Unit*.



Additional Information

If there is a mistake in any set value, it is highlighted in red. Move your mouse over any location for which an error is displayed to view the error message as a tooltip.

● Procedure to Open the Event Level Settings View

- 1 Click the Event Level Settings Button () in the Operation Settings tab page of the Edit Pane.

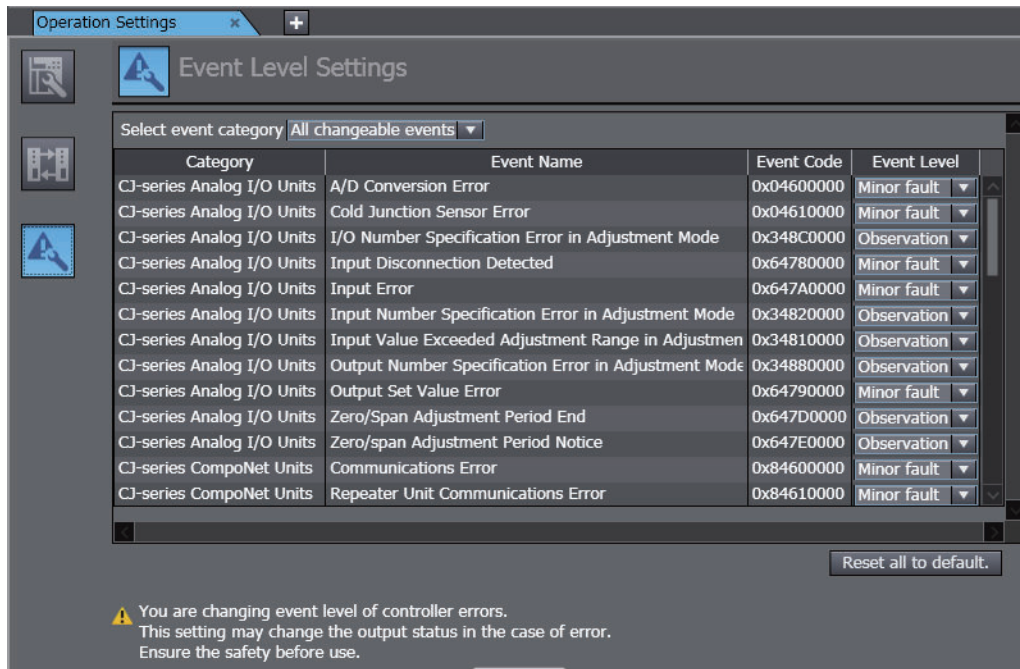

The event name and event code are displayed. You can change the event level.

Refer to the *NJ/NX-series CPU Unit Software User's Manual (Cat. No. W501)* or *NY-series Industrial Panel PC / Industrial Box PC Software User's Manual (Cat. No. W558)* for the Controller events for which you can change the event levels and the *NJ/NX-series Troubleshooting Manual (Cat. No. W503)* or *NY-series Troubleshooting Manual (Cat. No. W564)* for details on the events.



Version Information

A CPU Unit with unit version 1.03 or later and Sysmac Studio version 1.04 or higher are required to change the event levels.



Precautions for Correct Use

If you change the event level of a Controller error, the output status when the error occurs may change. Confirm safety before you change an event level.

● Transferring Operation Settings

Use the synchronize operation to transfer the operation settings to the Controller.

Refer to *Synchronizing (Uploading/Downloading after Automatic Verification)* on page 7-127 for more information on synchronizing.

- 1** Go online with the Controller.
- 2** Select **Synchronization** from the **Controller Menu**.
The Synchronization Window is displayed.
- 3** Select **Operation Settings** under the **Controller Setup** in the Synchronization Window and then click the **Transfer To Controller** Button.
The settings are transferred.

5-6-2 Built-in EtherNet/IP Port Settings

- Built-in EtherNet/IP Port Settings

These settings are made to perform communications using the built-in EtherNet/IP port of the Controller.





● Procedure to Open the Built-in EtherNet/IP Port Settings Tab Page

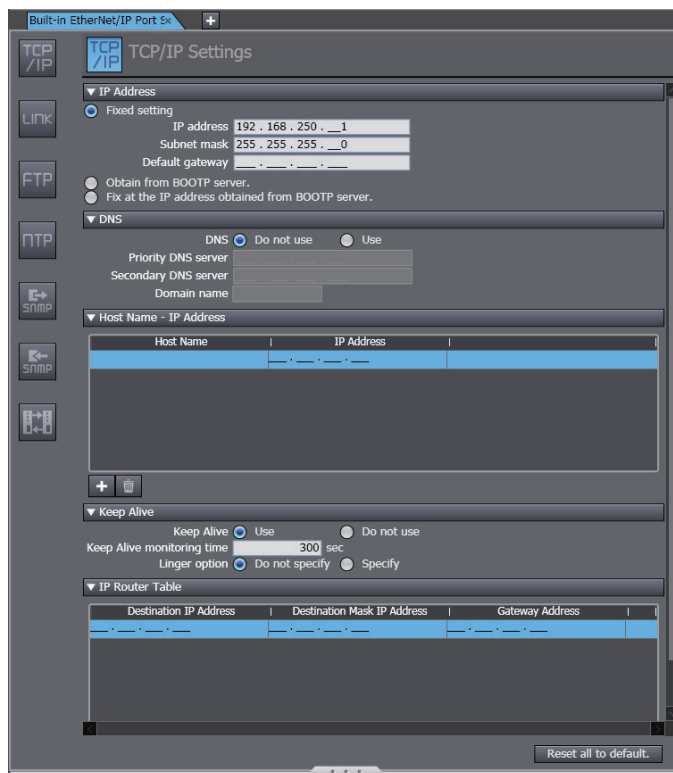



Double-click **Built-in EtherNet/IP Port Settings** under **Configurations and Setup - Controller Setup** in the Multiview Explorer. Or, right-click Built-in EtherNet/IP Port Settings and select **Edit** from the menu.

The **Built-in EtherNet/IP Port Settings** Tab Page is displayed.



Built-in EtherNet/IP Port Settings

Setting	Button	Description
TCP/IP Settings		Set the EtherNet/IP port TCP/IP settings.
Link Settings		Set the baud rate for the EtherNet/IP port.
		Select whether to use LLDP for the EtherNet/IP port. *1
FTP Settings		Select whether to use the FTP server, and set up the FTP server if it is required.
NTP Settings		Select whether to use NTP (automatic time setting), and set up NTP if it is required.

Setting	Button	Description
SNMP Set-tings		Select whether to use SNMP (Simple Network Management Protocol), and set up SNMP if it is required.
SNMP Trap Settings		Select whether to use SNMP traps (to detect network problems), and set up SNMP traps if they are required.
FINS Set-tings*2		Make the FINS communications settings for the built-in EtherNet/IP port. Refer to <i>FINS Settings</i> on page 5-63 for details.
CIP		Select whether to use the CIP message server. *3
		Select whether to use CIP routing. *4
		Select whether to use CIP Safety communications and whether to give priority to CIP Safety communications. *5
TCP/UDP Message Service*6		Select whether to use the TCP/UDP message service, and set up the TCP/UDP message service if it is used.

*1. This function can be used with the following CPU Unit versions.

NX102-□□00 and NX102-□□20: Ver. 1.68 or later
 NX502-1□00: Ver. 1.60 or later

*2. This is displayed only for an NJ-series Controller and NX102 or NX1P2 Controller.

*3. This function can be used with the following CPU Unit versions.

- NX102-□□00, NX102-□□20, NX1P2-□□□□DT, NX1P2-□□□□DT1
 NJ101-□□00, NJ101-□□20
 NJ301-1□00, NJ501-1□00, NJ501-1□20, NJ501-1340, NJ501-5300, NJ501-4□□□, NJ501-R□□□:
 Ver.1.49 or later
- NX502-1□00: Ver. 1.60 or later
- NX701-□□□□: Ver.1.29 or later

*4. This is displayed only for an NY-series Controller.

*5. This is displayed only for NX502-1□00 Ver. 1.64 or later.

*6. This is displayed only for an NX102 Controller.

Refer to the *NJ/NX-series CPU Unit Built-in EtherNet/IP Port User's Manual (Cat. No. W506)* or *NY-series Industrial Panel PC / Industrial Box PC Built-in EtherNet/IP Port User's Manual (Cat. No. W563)* for a list of the settings.

● Procedure to Open the Settings Views

The Built-in EtherNet/IP Port Settings Tab Page is used to configure settings. The TCP/IP Settings view is used as an example in the following procedure.

- 1** Click the TCP/IP Settings Button () on the Built-in EtherNet/IP Port Settings Tab Page. The TCP/IP Settings view is displayed.

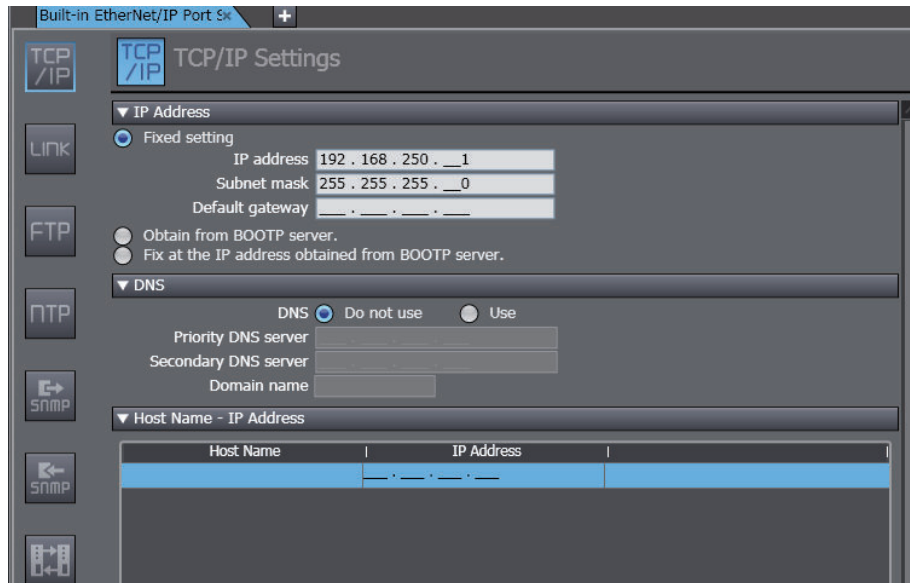

Use the same procedure to display the other settings views.

● Procedure to Download Built-in EtherNet/IP Port Settings

Use the synchronize operation to transfer the Built-in EtherNet/IP Port Settings to the Controller. Refer to *Synchronizing (Uploading/Downloading after Automatic Verification)* on page 7-127 for more information on synchronizing.

- 1** Go online with the Controller.
- 2** Select **Synchronization** from the **Controller** Menu.
The Synchronization Window is displayed.
- 3** Select **Built-in EtherNet/IP Port Settings** under the **Controller Setup** in the Synchronization Window and then click the **Transfer To Controller** Button.
The settings are transferred.



Precautions for Correct Use

You cannot undo and redo operations in the Built-in EtherNet/IP Port Settings Tab Page.



Additional Information

- If there is a mistake in any set value, it is highlighted in red. Move your mouse over any location for which an error is displayed to view the error message as a tooltip.
- If you select *Obtain from BOOTP Server* as the IP address acquisition method in the TCP/IP Settings, you can display the acquired IP address in the Controller Status Pane. Refer to the *Controller Status Monitor* on page 7-46 for the procedure to open the Controller Status Pane.

● Procedure to Open the FINS Settings View

- FINS Settings
Configure the FINS settings to perform FINS network communications from the built-in EtherNet/IP port of the NJ-series CPU Unit, or the NX502, NX102, or NX1P2 CPU Unit.

- 1 Click the FINS Settings Button () on the Built-in EtherNet/IP Port Settings Tab Page. The FINS Settings view is displayed.

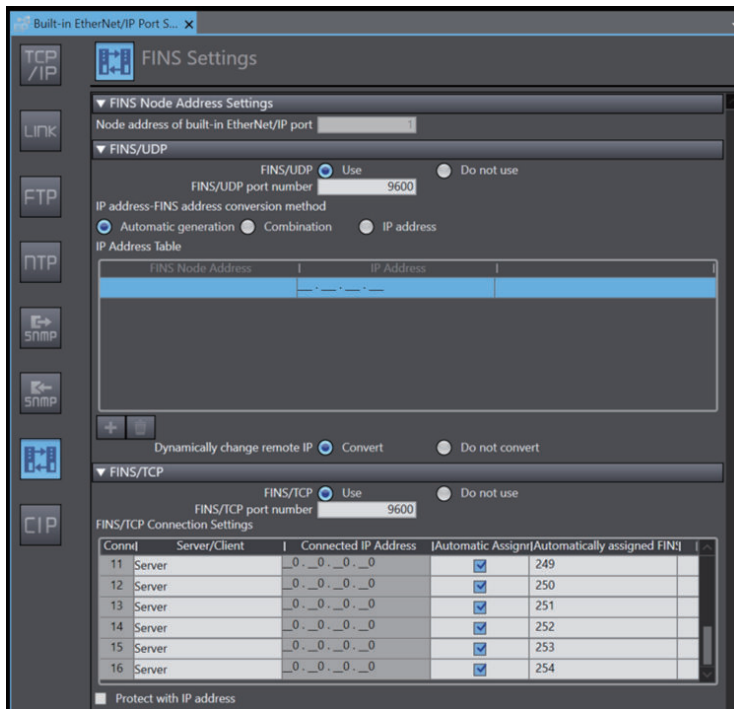

Category	Description
FINS Node Address Settings	Set the FINS node address.
FINS/UDP	Set FINS/UDP communications.
FINS/TCP*1	Set FINS/TCP communications.

*1. This is not displayed for an NX1P2 CPU Unit.

The settings are listed below for each setting category.

FINS Node Address Settings

Setting	Description	Set value	Default	Condition
Node address of built-in EtherNet/IP port*1	Set the FINS node address. The FINS node address is determined by the <i>IP Address-FINS Address Conversion Method</i> setting in the FINS/UDP settings.	1 to 254	1	The <i>IP Address- FINS Address Conversion Method</i> must be set to <i>Combination</i> or <i>IP Address</i> .

*1. The target port varies depending on the model. Refer to the *NJ/NX-series CPU Unit Built-in EtherNet/IP Port User's Manual (Cat. No. W506)* for details.

FINS/UDP

Setting	Description	Set value	Default	Condition
FINS/UDP*1	Set whether to use the communications protocol.	Use or Do not use	Use	---

Setting	Description	Set value	Default	Condition																					
FINS/UDP Port Number	Set the FINS/UDP port number.	1 to 65535 *2	9600	---																					
IP Address-FINS Address Conversion Method	<p>Select the conversion method to use when determining the FINS address from the IP address.</p> <ul style="list-style-type: none"> Automatic Generation The FINS node address is determined from the lower eight bits of the IP address as shown below. Lower 8 bits of subnet address are 0: The lower 8 bits of the IP address are set as the FINS node address. <p>Example:</p> <table border="1"> <thead> <tr> <th>IP address</th> <th>Subnet mask</th> <th>FINS node address</th> </tr> </thead> <tbody> <tr> <td>192.168.250.129</td> <td>255.255.255.0</td> <td>129</td> </tr> <tr> <td>192.168.250.129</td> <td>255.255.128.0</td> <td>129</td> </tr> <tr> <td>192.168.250.129</td> <td>255.255.0.0</td> <td>129</td> </tr> </tbody> </table> <ul style="list-style-type: none"> Lower 8 bits of subnet address are not 0: The host address that is created from the IP address and the subnet mask is set as the FINS node address. <p>Example:</p> <table border="1"> <thead> <tr> <th>IP address</th> <th>Subnet mask</th> <th>FINS node address</th> </tr> </thead> <tbody> <tr> <td>192.168.250.129</td> <td>255.255.255.128</td> <td>1</td> </tr> <tr> <td>192.168.250.129</td> <td>255.255.255.192</td> <td>1</td> </tr> </tbody> </table> <ul style="list-style-type: none"> Combination The address specified in the FINS node address setting or in the IP address table is used. IP Address The address set in the IP address table is used. 	IP address	Subnet mask	FINS node address	192.168.250.129	255.255.255.0	129	192.168.250.129	255.255.128.0	129	192.168.250.129	255.255.0.0	129	IP address	Subnet mask	FINS node address	192.168.250.129	255.255.255.128	1	192.168.250.129	255.255.255.192	1	Automatic Generation, Combination, or IP Address	Automatic Generation	---
IP address	Subnet mask	FINS node address																							
192.168.250.129	255.255.255.0	129																							
192.168.250.129	255.255.128.0	129																							
192.168.250.129	255.255.0.0	129																							
IP address	Subnet mask	FINS node address																							
192.168.250.129	255.255.255.128	1																							
192.168.250.129	255.255.255.192	1																							
IP Address Table	Set the table of corresponding IP addresses and FINS addresses to determine the FINS addresses.	FINS node address: 1 to 254	Blank	The <i>IP Address-FINS Address Conversion Method</i> must be set to <i>Combination</i> or <i>IP Address</i> .																					

Setting	Description	Set value	Default	Condition
Dynamically Change Remote IP	Set whether to dynamically change the IP address of the remote node.	Convert or Do Not Convert	Convert	---

*1. This is displayed if the unit version of the CPU Unit is 1.49 or later.

*2. Port numbers that are reserved by the system cannot be set. Refer to the *NJ/NX-series CPU Unit Built-in EtherNet/IP Port User's Manual (Cat. No. W506)* for details.

FINS/TCP

Setting	Description	Set value	Default	Condition	
FINS/TCP*1	Set whether to use the communications protocol.	Use or Do not use	Use	---	
FINS/TCP Port Number	Set the FINS/TCP port number.	1 to 65535* 2	9600	---	
FINS/TCP Connection Settings	Connection No.	Cannot be changed	No. 1 to No. 16	---	
	Server/Client	Set if this is a server or a client.	Server/Client	---	
	Connected IP address	Set the IP address to connect to.	*3	0.0.0.0	The <i>Protect with IP Address</i> Option must be selected or <i>Server/Client</i> must be set to <i>Client</i> .
	Automatic Assignment	Set whether to use automatic assignment.	Selected or not selected	Selected.	<i>Server/Client</i> must be set to <i>Server</i> .
	Automatically assigned FINS node address	Set the FINS address that corresponds to the IP address.	1 to 254	239 to 254 (line 1 to line 16)	<i>Server/Client</i> must be set to <i>Server</i> and <i>Automatic Assignment</i> must be selected.
	Protect with IP Address	When the Controller is the client, protection is provided with the destination IP address.	---	---	---

*1. This is displayed if the unit version of the CPU Unit is 1.49 or later.

- *2. Port numbers that are reserved by the system cannot be set. Refer to the *NJ/NX-series CPU Unit Built-in EtherNet/IP Port User's Manual (Cat. No. W506)* for details.
- *3. Refer to the *NJ/NX-series CPU Unit Built-in EtherNet/IP Port User's Manual (Cat. No. W506)* for details on the setting ranges of IP addresses.

5-6-3 Built-in I/O Settings

You can configure the built-in I/O port settings for an NX1P2 Controller.

● Procedure to Open the Built-in I/O Settings Tab Page

- 1 Double-click **Built-in I/O Settings** under **Configurations and Setup - Controller Setup** in the Multiview Explorer. Or, right-click Built-in I/O Settings and select **Edit** from the menu. The **Built-in I/O Settings** Tab Page is displayed.

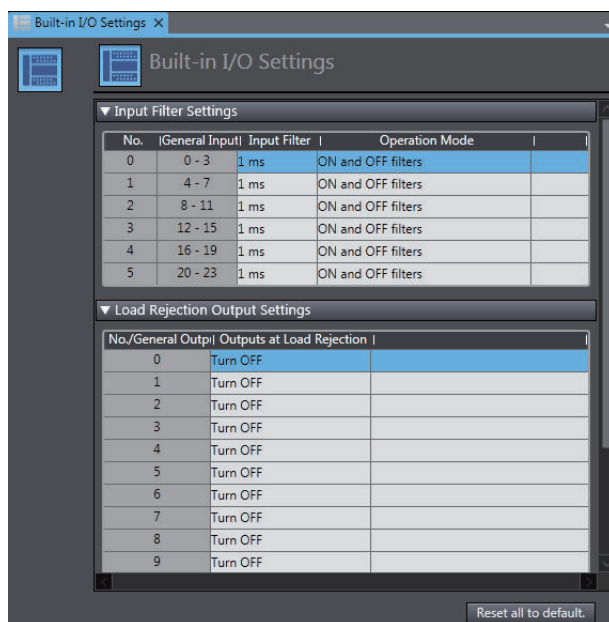

Refer to the *NX-series NX1P2 CPU Unit Built-in I/O and Option Board User's Manual (Cat. No. W579)* for details on the setting items.

5-6-4 Option Board Settings

You can configure the Option Board settings for an NX1P2 Controller.

● Procedure to Open the Option Board Settings Tab Page

- 1 Double-click **Option Board Settings** under **Configurations and Setup - Controller Setup** in the Multiview Explorer. Or, right-click Option Board Settings and select **Edit** from the menu. The **Option Board Settings** Tab Page is displayed.

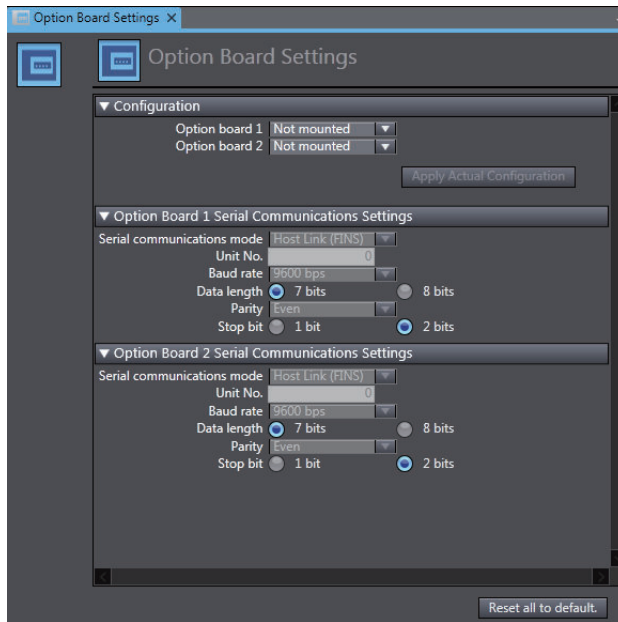

Refer to the *NX-series NX1P2 CPU Unit Built-in I/O and Option Board User's Manual (Cat. No. W579)* for details on the setting items.

● Reading the Actual Configuration

You can read the configuration of actually mounted Option Boards for display in the Sysmac Studio while online.

- 1 Go online and click the **Apply Actual Configuration** Button.
The current settings configured in the Sysmac Studio are compared with the actual configuration and the results are displayed.
- 2 To apply the actual configuration to the Sysmac Studio when the comparison results show a difference, click the **Yes** Button.
The actual configuration is applied to the Option Boards in the Sysmac Studio.

5-6-5 Memory Settings

You can configure the memory used for CJ-series Units for an NX502, NX102, or NX1P2 Controller.

● Procedure to Open the Memory Settings Tab Page

- 1 Double-click **Memory Settings** under **Configurations and Setup - Controller Setup** in the Multiview Explorer. Or, right-click Memory Settings and select **Edit** from the menu.
The **Memory Settings for CJ-series Units** Tab Page is displayed.

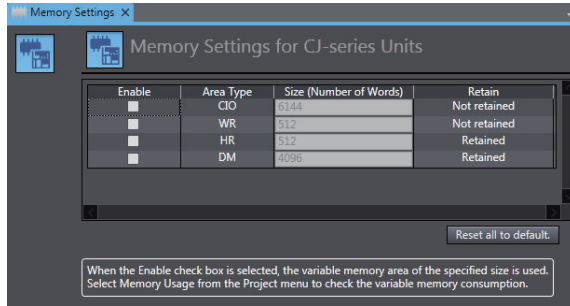

Refer to the *NJ/NX-series CPU Unit Software User's Manual (Cat. No. W501)* for details on the setting items.



Additional Information

Configuring the memory used for CJ-series Units allows the use of variable memory according to the set memory size. Refer to *8-4 User Memory Usage Monitor* on page 8-49 for the check procedure for the usage of variable memory.

5-7 Motion Control Setup

- Motion Control Setup

The Motion Control Setup is used to create the axes to use in motion control instructions, assign those axes to Servo Drives and encoders, and set axis parameters.

5-7-1 Setting Axes

- 1 Right-click **Axis Settings** under **Configurations and Setup – Motion Control Setup** in the Multiview Explorer and select **Add – Motion Control Axis** or **Single-axis Position Control Axis** from the menu.

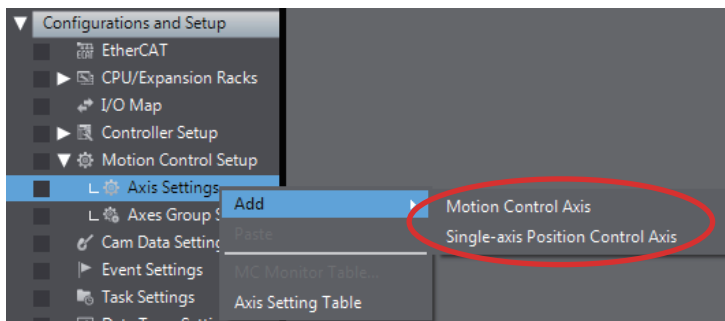

The axis *MC_Axis000(0)* is added under **Axis Settings**.

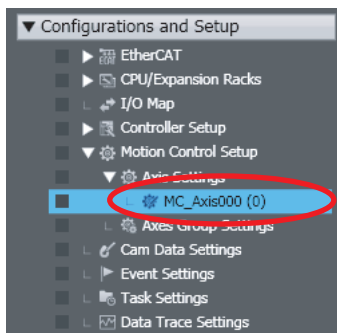

The number in parentheses in *MC_Axis000(0)* is the axis number.

For an NX/NY-series Controller, axes are displayed in the following form: *MC_Axis000(0,MC1)*.

The axis number and the task that executes the motion controls are in the parentheses.

*1. This is displayed only for an NX102 or NX1P2 Controller.

- 2 Double-click *MC_Axis000(0)*.

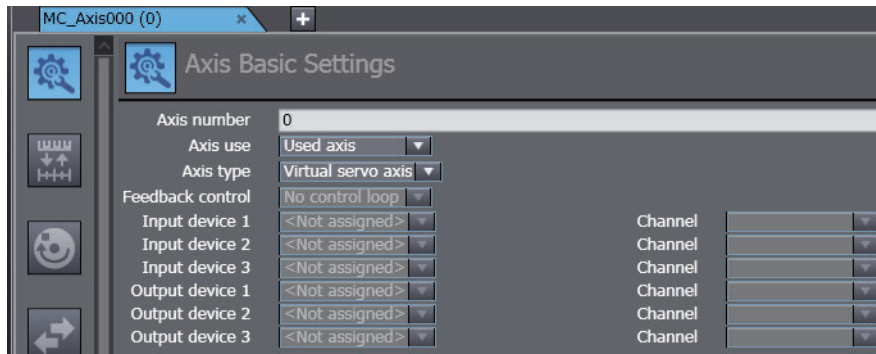

The Axis Parameter Settings tab page is displayed in the Edit Pane. The *basic parameters* are displayed on the initial display.

- 3 Select the following settings to use a servo axis.
 - a) *Axis Use*: *Used Axis* or *Unused axis (changeable to used axis)*
 - b) *Axis Type*: *Servo Axis*
- 4 Select a servo for the Output device 1 setting.

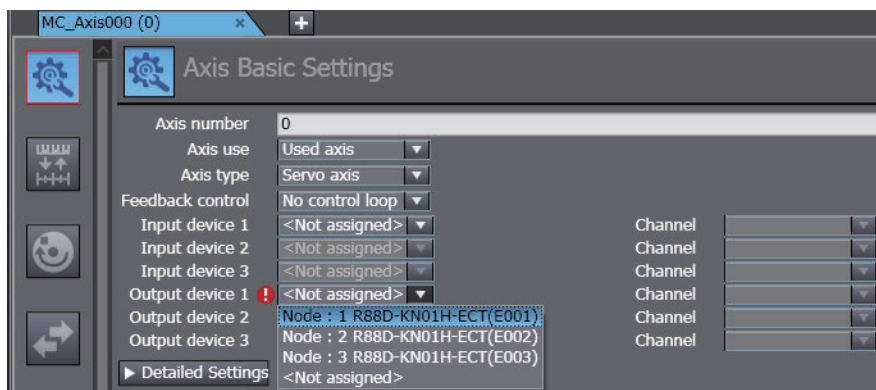

Note Refer to 5-2 *EtherCAT Configuration and Setup* on page 5-4 for the procedure to set slaves.









Additional Information

For an NJ-series CPU Unit with a unit version of 1.04 or earlier, select the Servo that is registered as the *input device*.

- 5 Click the buttons on the left side of the Axis Basic Settings Tab Page to complete different settings. The parameters you can set for each button are given below.

Settings Buttons and Axis Parameters

Button	Name	Description
	Axis Basic Settings	Set the task to execute motion controls, ^{*1} whether to use the axis, the axis type, the axis number, control function ^{*2} an input or output device, and the channel.
	Unit Conversion Settings	Set the unit of display and gear ratio of the electronic gear. Set number of command pulses and the travel distance per motor rotation. With a CPU Unit with unit version 1.11 or later, you can set items for using a reducer.

Button	Name	Description
	Operation Settings	Set the velocity, acceleration rate, deceleration rate, torque warning values, and other monitor parameters.
	Other Operation Settings	Set the I/O for the Servo Drive.
	Limit Settings	Set software limits and following error limits.
	Homing Settings	Set the homing operation.
	Position Count Settings	Set Count Mode of the Controller.
	Servo Drive Settings	Set the Servo Drive parameters.

- *1. This item is set for an NX701 Controller. The setting item is not displayed for an NJ-series Controller.
- *2. This is displayed only for an NX102 or NX1P2 Controller. In the default setting, **All** is selected if you added **Motion Control Axis** or **Single-axis position control only** is selected if you added **Single-axis Position Control Axis**.

Refer to the *NJ/NX-series CPU Unit Motion Control User's Manual (Cat. No. W507)* or *NY-series Industrial Panel PC / Industrial Box PC Motion Control User's Manual (Cat. No. W559)* for details on each setting.



Precautions for Safe Use

If you change the detailed settings of the **Axis Basic Settings** Tab Page, make sure that the device or machine performs the expected operation before you start actual operation. If the relationship between the functions of the Motion Control Function Module and the EtherCAT slave process data that is assigned to the axes are not correct, the device or machine may perform unexpected operation.



Additional Information

Parameters that you change in the Axis Parameter Settings Tab Page are automatically updated in the Axis Setting Table.

Setting the Task to Execute Motion Control

When you register an axis, the primary periodic task is set by default as the task to execute motion control.

With an NX701 Controller, you can set the task to execute motion control to either the primary periodic task or the priority-5 periodic task.

Use the following procedure to set the priority-5 periodic task as the task to execute motion control.

- 1** Register the priority-5 periodic task in the **Task Settings**. Refer to *5-9-1 Registering Tasks* on page 5-125 for the task registration procedure in the **Task Settings**.

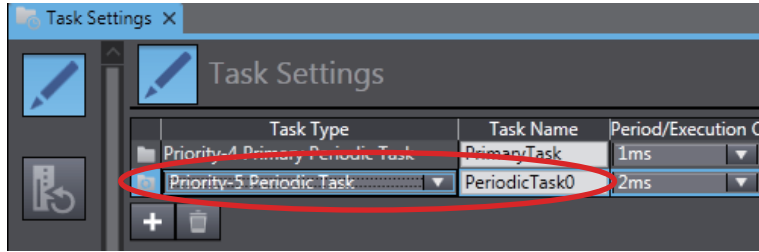

- 2** In the **I/O Control Task Settings** under the **Task Settings**, select the task for the priority-5 periodic task as the task for the slave/Unit assigned to the axis.

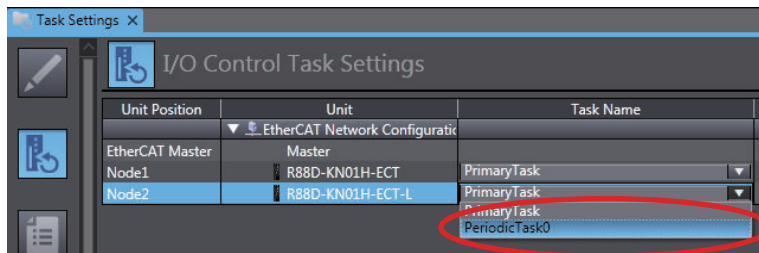

- 3** Select the slave/Unit to which you assigned the priority-5 periodic task for the input device or output device in the **Axis Basic Settings**.

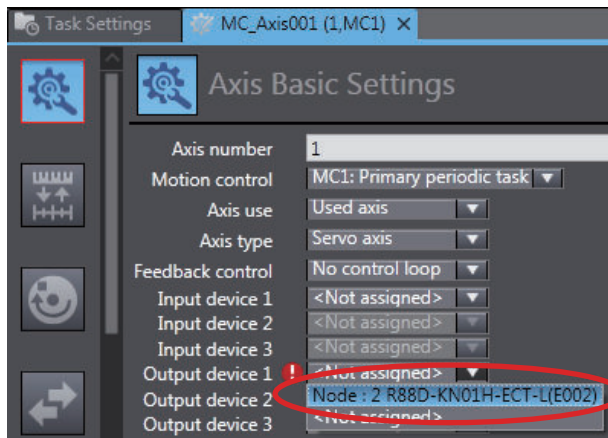

- 4** Select the priority-5 periodic task in the **Motion control** Box.

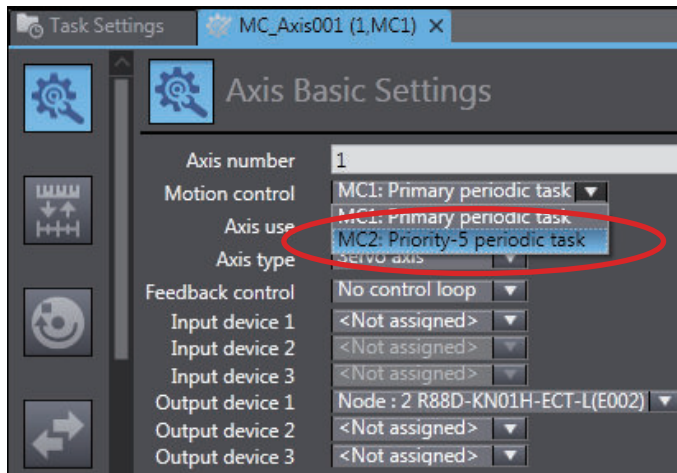

The priority-5 periodic task is set as the task to execute motion control.



Precautions for Correct Use

- If you assign a slave/Unit to an axis, the task that is set in the **Axis Basic Settings** is given priority over the task that is set in the **I/O Control Task Settings** under the **Task Settings** as the task assigned to that slave/Unit.
To change the task assignment for a slave/Unit that is assigned to a task for an NX701 Controller, change the task that is set for motion control in the **Axis Basic Settings**. The task in the **I/O Control Task Settings** in the **Task Settings** for the slave/Unit is automatically changed to the task that is set in the **Axis Basic Settings**.
- If you want to assign a different task in the **I/O Control Task Settings** in the **Task Settings** for a slave/Unit that is assigned to an axis, clear the slave/Unit selection for the input device or output device in the **Axis Basic Settings** first.

Axis Setting Table

● Axis Setting Table

The Axis Setting Table is a table of all registered axis parameters.

You can edit any axis parameters here just as you can on the Axis Settings Tab Page.

● Opening the Axis Setting Table

- 1 Right-click **Axis Settings** under **Configurations and Setup – Motion Control Setup** and select **Axis Setting Table** from the menu.

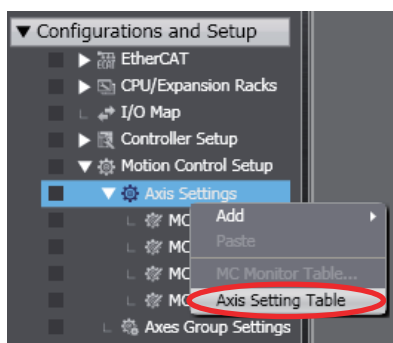

The Axis Setting Table is displayed.

Axis Name	1 MC_Axis000(0)	2 MC_Axis001(1)	3 MC_Axis002(2)	4 MC_Axis003(3)
Axis Basic Settings				
Axis use	Used axis	Used axis	Used axis	Used axis
Axis type	Servo axis	Servo axis	Servo axis	Servo axis
Feedback control	No control loop	No control loop	No control loop	No control loop
Input device 1	-	-	-	-
Channel	-	-	-	-
Input device 2	-	-	-	-
Channel	-	-	-	-
Input device 3	-	-	-	-
Channel	-	-	-	-
Output device 1	Node : 1	Node : 2	Node : 3	Node : 4
Channel	CH1	CH1	CH1	CH1
Output device 2	-	-	-	-
Channel	-	-	-	-
Output device 3	-	-	-	-
Channel	-	-	-	-
Unit Conversion Settings				
Unit of display	pulse	pulse	pulse	pulse
Command pulse count per rev	10000 pulse/rev	10000 pulse/rev	10000 pulse/rev	10000 pulse/rev
Work travel distance per rev	10000 pulse/rev	10000 pulse/rev	10000 pulse/rev	10000 pulse/rev

Note Each line represents an axis parameter, and each column is for one axis number. All registered axes are displayed. You can collapse the table by axis parameter category.

● Changing Axis Parameters

- 1 Click the parameter to change.
- 2 Enter the new setting for the parameter.

● Copying Axis Parameters

- 1 Right-click the cell to copy and select **Copy** from the menu.
- 2 Right-click the cell to paste in and select **Paste** from the menu.



Additional Information

Hold down the Ctrl or Shift Key and click cells to select more than one cell.

● Copying All of the Axis Parameters at the Same Time

- 1 Right-click the axis name of the axis parameters to copy and select **Copy Selected Columns** from the menu.
- 2 Right-click the axis name of the axis parameters to paste in and select **Paste** from the menu.

● Adding an Axis

Right-click the axis name and select **Add New Axis**. A new axis is added to the right side of the Axis Setting Table.



Additional Information

You can also copy an existing axis to add a new axis. Right-click the axis name from which to copy the parameters and select **Copy**, and then right-click and select **Add New Axis and Paste the Settings**.

● Filtering Axis Parameters

You can switch between displaying all axis parameters and only those that are used the most often.

- 1 Open the Axis Setting Table.
- 2 Select either **All** or **Basic Settings** under **Parameters** to show at the top of the Axis Setting Table.

● Selectively Displaying Axis Parameters

You can select the axis parameters to display.

- 1 Open the Axis Setting Table.
- 2 Right-click anywhere in the Axis Setting Table and select **Select Axes to Show** from the menu. The following Select Axes to Show Dialog Box is displayed.
NX701 Controllers



NJ/NY-series Controllers and NX502, NX102, or NX1P2 Controllers

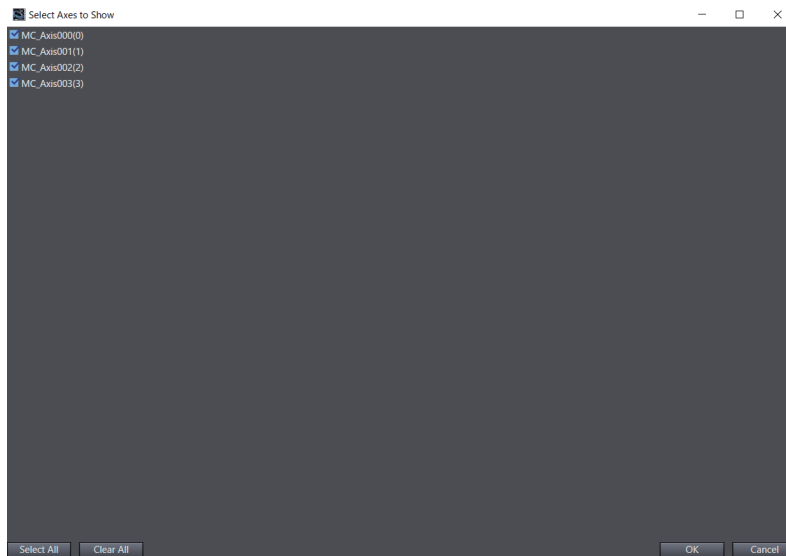

Button	Description	Remarks
Select MC1: Primary Periodic Task	Selects only the axes for which motion control processing is executed in the primary periodic task (MC1).	This is displayed only for an NX701 Controller.
Select MC2: Priority-5 Periodic Task	Selects only the axes for which motion control processing is executed in the priority-5 periodic task (MC2).	This is displayed only for an NX701 Controller.
Select All	Selects all of the axes.	
Clear All	Clears the selections of all of the axes.	

- 3** Select the axes to display and click the **OK** Button.
Only the selected axes are displayed in the Axis Setting Table.



Additional Information

Any changes made in the Axis Setting Table are automatically updated in the Axis Parameter Settings Tab Page.

Updating Axis Settings with Drive Information

If 1S-series or G5-series Servo Drives (excluding Linear Servo Drives) are assigned to axes whose axis type is set to Servo Axis, you can acquire information from the Servo Drives to update the axis settings.

The following axis settings will be updated.

Unit Conversion Settings: Command pulse count per motor rotation, travel distance per motor rotation, work travel distance per rotation

Operation Settings: Maximum velocity, maximum jog velocity

Other Operation Settings: Maximum positive torque limit, maximum negative torque limit

Position Count Settings: Encoder type

Perform the following procedure with the Sysmac Studio connected online with a Controller.

- 1 Right-click **Axis Settings** in the Multiview Explorer and select **Apply drive data to axis settings** from the menu.

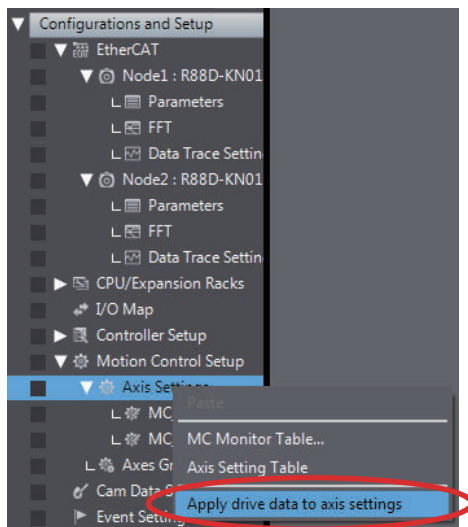

An update confirmation dialog box is displayed.

- 2 Click the **Yes** Button.
The results are displayed when the update of the axis settings is completed.

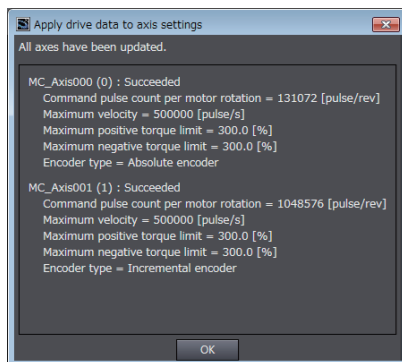

- 3 Check the values of the updated axis settings.

5-7-2 Exporting and Importing Axis Settings

You can export axis settings to an XML file and import the file into a different project. All items displayed in the Axis Parameter Settings tab page are subject to export and import.

To edit an exported file with Sysmac Studio or to create an import file using software other than Sysmac Studio, refer to the XML schema in the paths below. Help provides the information on the XML file format.

			Location (Default installation)	File
XML schema	For Sysmac Studio 32-bit application	For 32-bit OS	C:\Program Files\OMRON\Sysmac Studio\Sample\Motion Control Setup\Axis Settings	AxisSettingFileSchema_Rev{format version}.xsd
		For 64-bit OS	C:\Program Files (x86)\OMRON\Sysmac Studio\Sample\Motion Control Setup\Axis Settings	
	For Sysmac Studio 64-bit application		C:\Program Files\OMRON\Sysmac Studio\Sample\Motion Control Setup\Axis Settings	
Help	Sysmac Studio 32/64-bit application		C:\Program Files\OMRON\Sysmac Studio\Help	AxisSettingsXmlFileInformation.html



Version Information

The axis setting export and import functions are available in projects for the NJ/NX/NY series CPU Units with version 1.14 or later.

How to Export Axis Settings

- 1 Right-click **Axis Settings** under **Configurations and Setup - Motion Control Setup** in the Multiview Explorer and select **Export** from the menu.

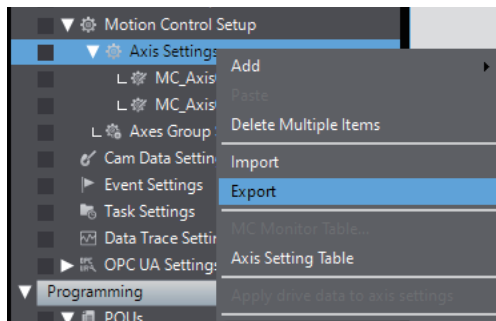

The **Axis setting Export** dialog box appears.

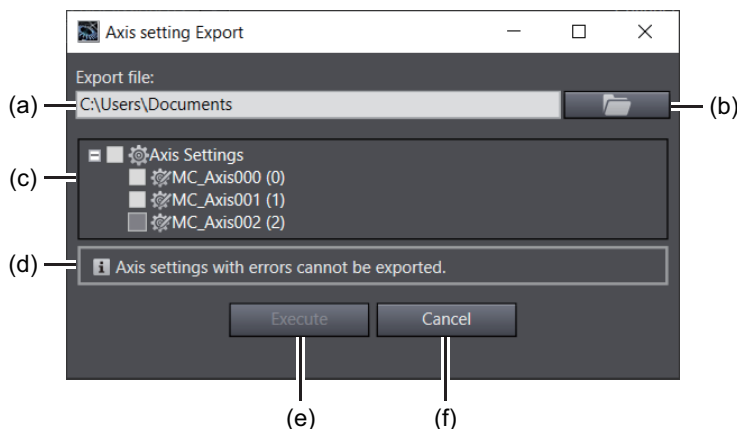

No.	Item	Description
(a)	Export file	This box shows the path of the file you export.

No.	Item	Description
(b)	File selection dialog box button	You can specify the path of the file to export.
(c)	Axis settings	You can select axes settings to export. If there is an error in an axis setting, you cannot select it.
(d)	Error message	This message will appear when there is an error in an axis setting.
(e)	Execute button	This button executes the export process for axis settings.
(f)	Cancel button	This button stops exporting axis settings and closes the dialog box.

2 Click the file selection dialog box button.

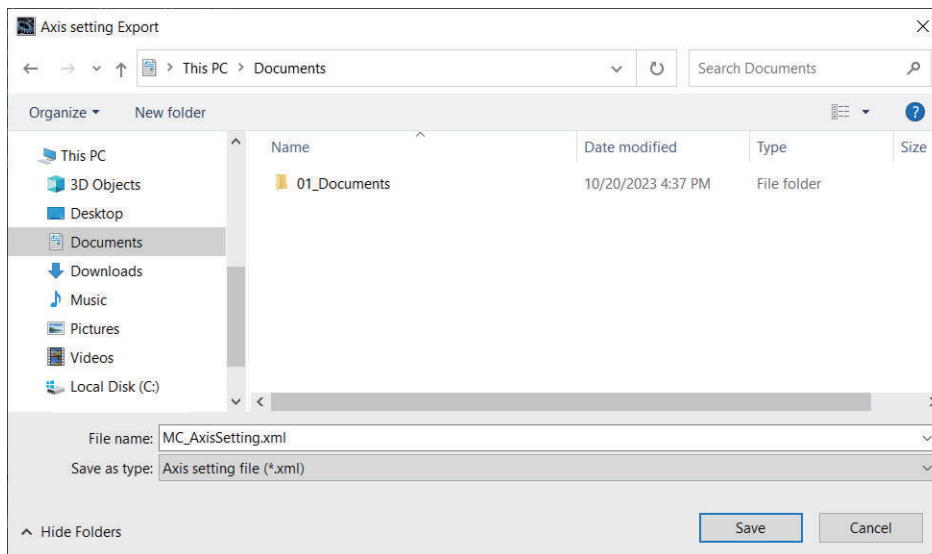

The file selection dialog box appears.

3 In the file selection dialog box, specify the path of the file you export, and then click the **Save** button.

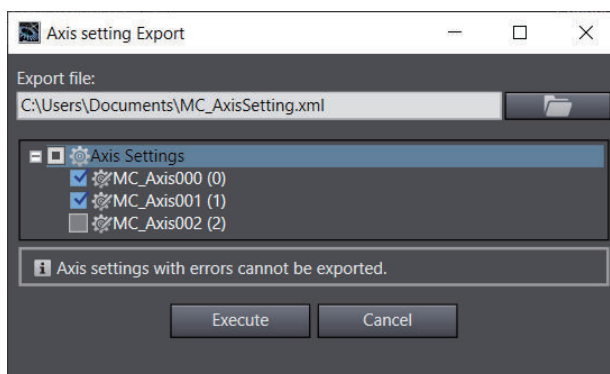

You will be back to the **Axis setting Export** dialog box. The **Export file** box shows the file path you have selected in the file selection dialog box.

4 Select an axis setting you export, and click the **Execute** button.

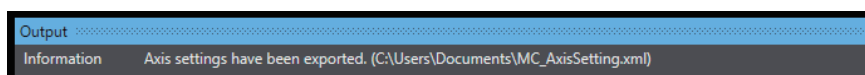

The Output tab page shows the export result.

How to Import Axis Settings

- 1 Right-click **Axis Settings** under **Configurations and Setup - Motion Control Setup** in the Multiview Explorer and select **Import** from the menu.

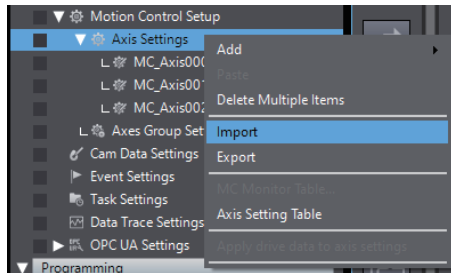

The confirmation message appears.

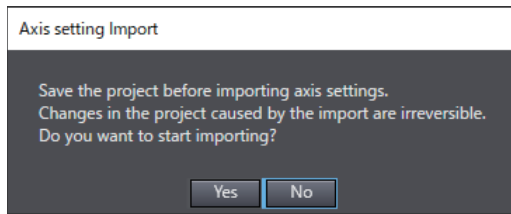

Clicking the **Yes** button displays the **Axis setting Import** dialog box.

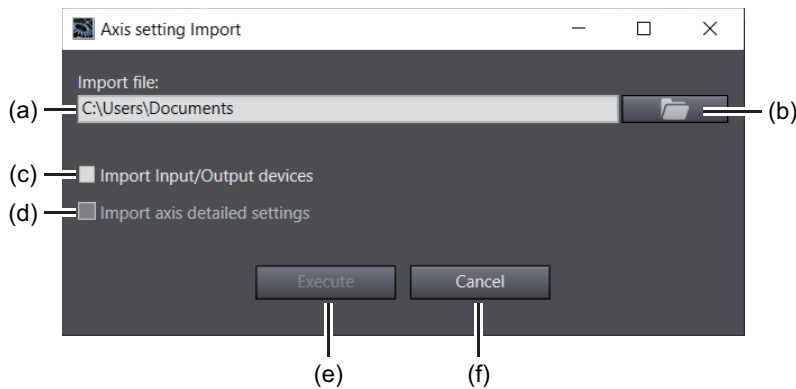

No.	Item	Description
(a)	Import file	This box shows the path of the file you import.
(b)	File selection dialog box button	You can specify the path of the file to import.
(c)	Import options*1	Selecting this option assigns devices to Input device 1 to 3 and Output device 1 to 3, respectively, according to the import file.
(d)	Import Input/Output devices	
(d)	Import axis detailed settings	Selecting this option imports the detailed axis settings according to the import file.
(e)	Execute button	This button executes the import process for axis settings.

No.	Item	Description
(f)	Cancel button	This button stops importing axis settings and close the dialog box.

*1. The import result depends on what you have selected in the dialog box. Refer to *Effects of Import Conditions on Results* on page 5-93 for details.

2 Click the file selection dialog box button.

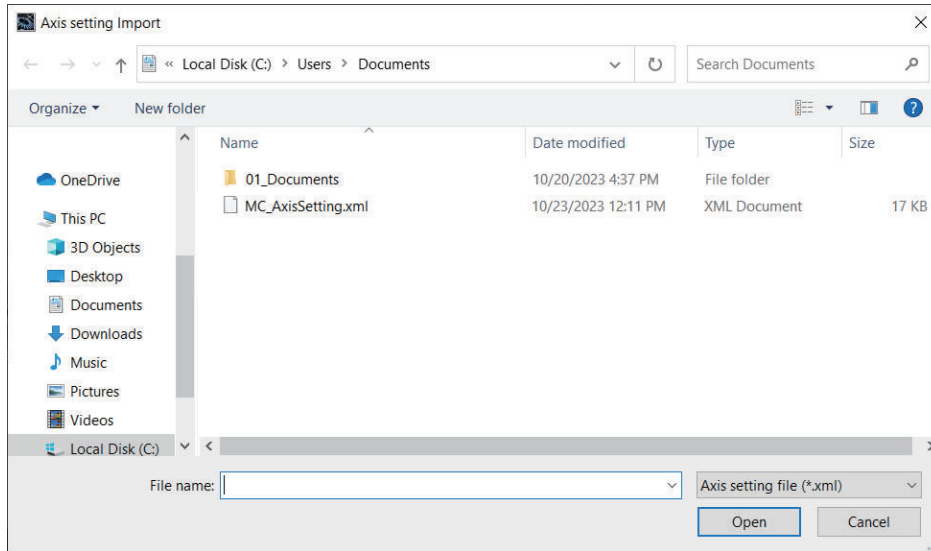

The file selection dialog box appears.

3 In the file selection dialog box, select the axis setting file you import, and then click the **Open** button.

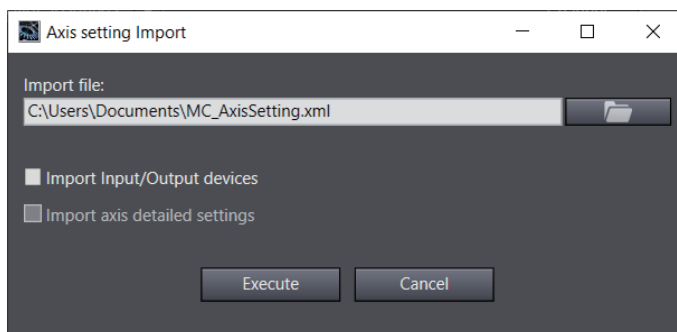

The **Import file** box shows the file path you have selected in the file selection dialog box.

4 Select import options and click the **Execute** button.

If the devices in the import file and the project are different, the following dialog box will appear. Refer to *Comparison Among Devices in Import File and Project* on page 5-94 for detailed information on the dialog box.

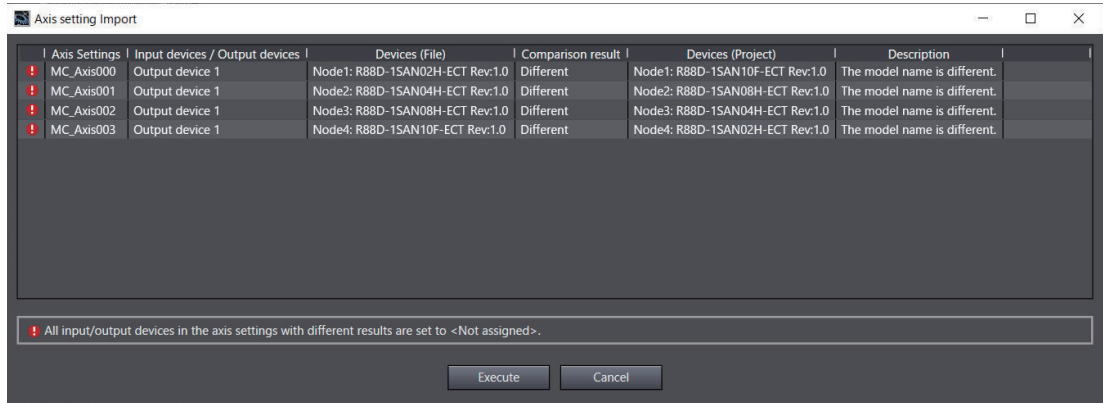

Review the differences, and if you want to apply the import file to the project, click the **Execute** button.

5 When the completion message appears, click the **OK** button.

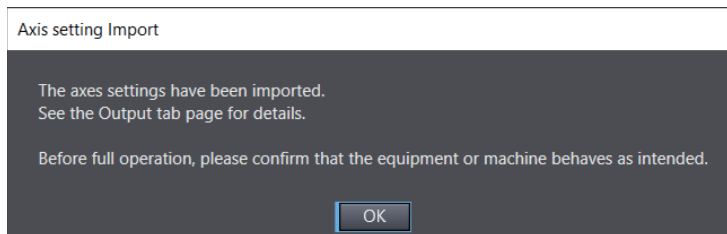

The Output tab page shows the import results.

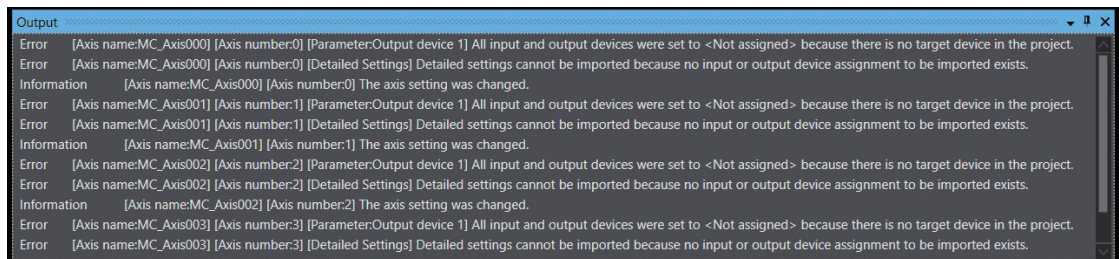

Precautions for Correct Use

Check the system operation with the imported axis settings carefully before the actual operation.

Effects of Import Conditions on Results

The table below shows differences in import results following to the import options in the **Axis setting Import** dialog box.

		Selection		
Import option	Import Input/ Output devices	No	Yes	Yes
	Import axis detailed settings	No (Selecting the Import Input/Output devices option disables this option)	No	Yes
Import result		The settings before import will be retained for Input devices 1 to 3/ Output devices 1 to 3 and the detailed axis settings.	Devices will be assigned to Input devices 1 to 3 and Output devices 1 to 3. Default values will be set for the detailed axis settings.	Devices will be assigned to Input devices 1 to 3 and Output devices 1 to 3. The detailed axis settings will be imported.
Note		When all of Input devices 1 to 3 and Output devices 1 to 3 are “<Not assigned>,” detailed axis settings will not be available.		



Additional Information

When the **Axis type** set in the import file is *Virtual servo axis* or *Virtual encoder axis*, in the import result, Input devices 1 to 3 and Output devices 1 to 3 will be set to <Not assigned> regardless of whether or not the check boxes are selected.

Comparison Among Devices in Import File and Project

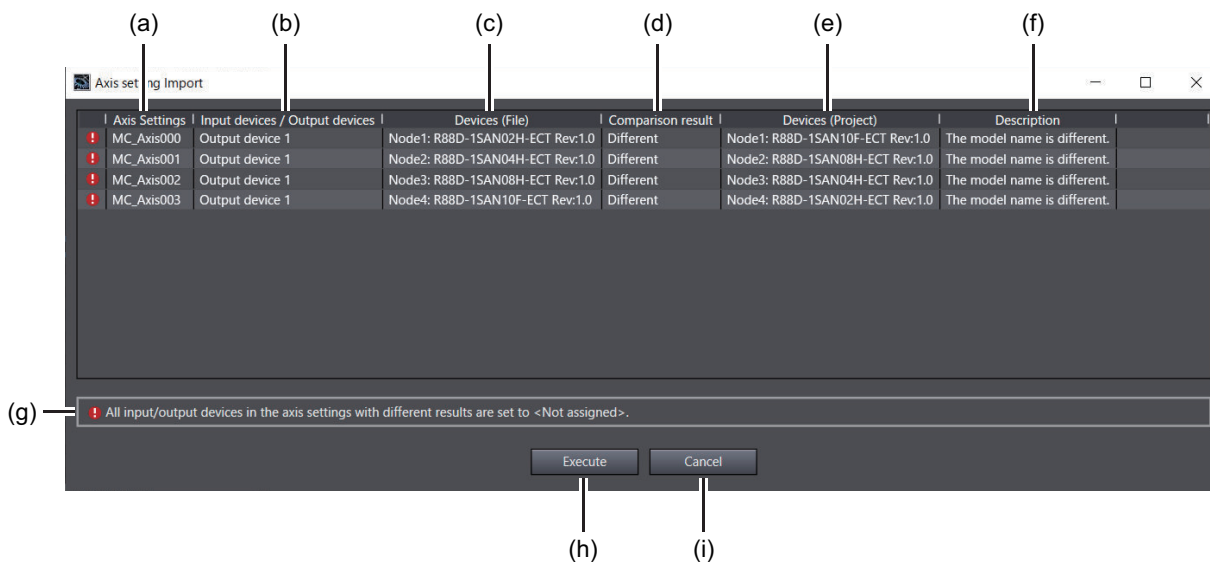

No.	Item	Description
(a)	Axis Settings	Displays axis names.
(b)	Input devices / Output devices	Displays either of Input Device 1 to 3 or Output Device 1 to 3, items of Axis Basic Settings.
(c)	Devices (File)	Displays the devices specified in the import file. The node number, model, version, revision, and other information for each device are included. The symbol, “---”, is displayed for an unidentified device.

No.	Item	Description
(d)	Comparison result	Displays comparison results of devices in the import file and the project. Refer to <i>Determination Criteria for Device Comparison</i> on page 5-96 for criteria in determining comparison results.
(e)	Devices (Project)	Displays the devices in the project, which correspond to the device node numbers in the import file. The node number, model, version, revision, and other information for each device are included. “---” means that the device specified in the import file does not exist in the project.
(f)	Description	Displays detailed information about the results.
(g)	Error/warning message	Displays detail information and notes about the import process.
(h)	Execute button	Executes the import process for axis settings.
(i)	Cancel button	Stops importing axis settings and close the dialog box.

● Determination Criteria for Device Comparison

○: Same, ×: Different

---: Indeterminable

	Node address	Model	Revision	Comparison result	Description*1
EtherCAT slave	○	○	○*2	Not displayed.	Not displayed.
	○	○	×	Different revision	Blank
	○	×	---	Different	The model name is different.
	×	---	---	Different	The device is not found in the project.
	Devices that should be included in the import file cannot be determined			Different	The device is not found in the file.

	Node address	Unit number	Model	Version	Comparison result	Description*1
NX Unit	○*3	○	○	○*2	Not displayed.	Not displayed.
	○*3	○	○	×	Different version	Blank
	○*3	○	×	---	Different	The model name is different.
	○*3	×	---	---	Different	The device is not found in the project.
	×*3	---	---	---	Different	The device is not found in the project.
	Devices that should be included in the import file cannot be determined				Different	The device is not found in the file.

	Node address	Slot number	Model	Comparison result	Description*1
MDP module	○	○	○	Not displayed.	Not displayed.
	○	○	×	Different	The model name is different.
	○	×	---	Different	The device is not found in the project.
	×	---	---	Different	The device is not found in the project.
	Devices that should be included in the import file cannot be determined			Different	The device is not found in the file.

*1. These are displayed in the **Description** column in the **comparison among devices in import file and project** dialog box.

*2. A device whose version or/and revision is/are omitted is considered as the same device.

*3. The node address of an NX Unit in CPU/Expansion Racks is not used for determination.

5-7-3 Deleting Multiple Axis Settings

You can delete multiple axis settings all at once by selecting them on the dialog box.



Version Information

This function is available in projects for the NJ/NX/NY series CPU Units with version 1.05 or later.

How to Delete Multiple Axis Settings

- 1 Right-click **Axis Settings** under **Configurations and Setup – Motion Control Setup** in the Multiview Explorer and select **Delete Multiple Items** from the menu.

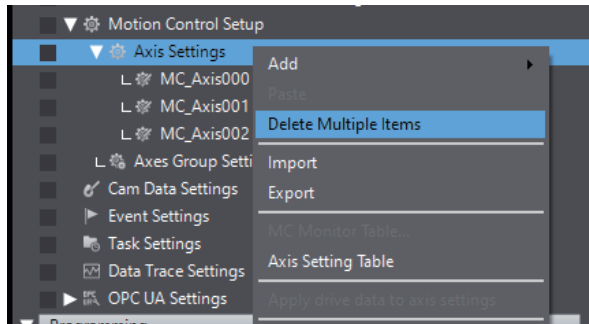

The **Delete Multiple Axis Settings** dialog box appears.

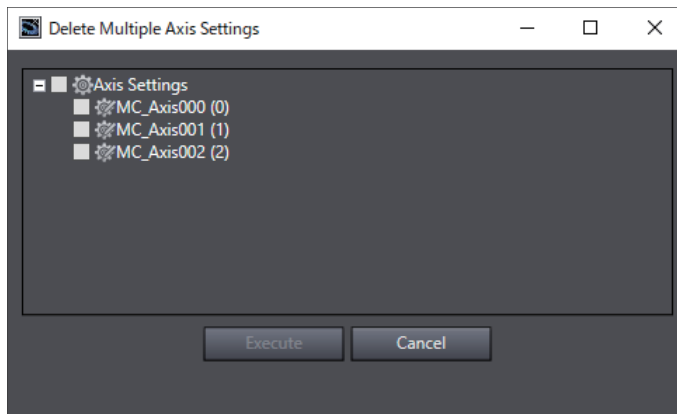

- 2 Select axis settings to delete and click the **Execute** button. The confirmation message appears.

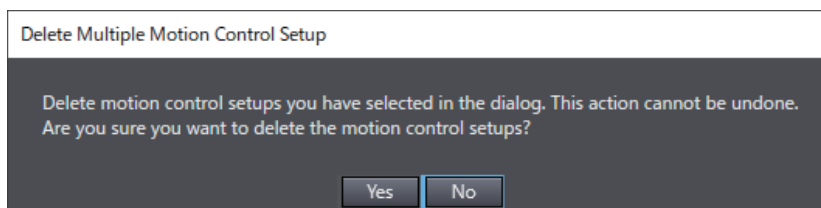

- 3 Click the **Yes** button. The selected axis settings are deleted.

5-7-4 Setting Axes Groups

- Setting Axes Groups
You can set axes to perform interpolated motions as an axes group.

● **Procedure to Set Axes Groups**

- Opening the Axes Group Settings Tab Page

1 Right-click **Axes Group Settings** under **Configurations and Setup - Motion Control Setup** in the Multiview Explorer and select **Add - Axes Group Settings** from the menu.

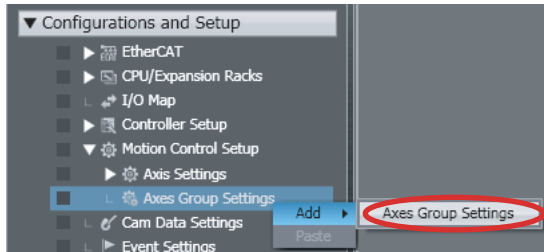

2 The axes group *MC_Group000(0)* is added under **Axes Group Settings**.



The number in parentheses in *MC_Group000(0)* is the axes group number. For an NX/NY-series Controller, axes groups are displayed in the following form: *MC_Group000(0,MC1)*. The axes group number and the task that executes the motion controls are in the parentheses.

3 Double-click *MC_Group000(0)*. The Edit Pane for Axes Group Basic Settings is displayed.

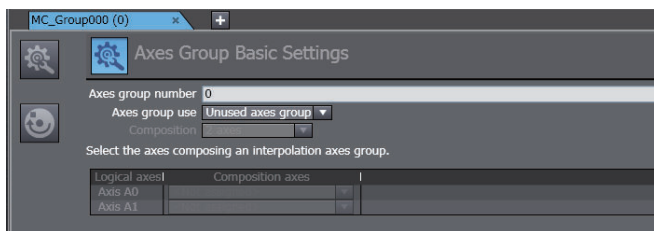

4 Click the buttons on the left side of the Axes Group Basic Settings Tab Page to change between different settings.

The parameters you can set for each button are given below.

Settings Buttons and Axes Group Parameters

Button	Name	Description
	Axes Group Basic Settings	Set the axes group number, the task to execute motion controls,*1 whether to use the axes group, or the axis composition.

Button	Name	Description
	Axis Group Operation Settings	Set the interpolated velocity, the maximum interpolated acceleration and deceleration, and the interpolated operation settings.

*1. This item is set for an NX701 Controller. The setting item is not displayed for an NJ-series Controller.

For details on each item, refer to the *NJ/NX-series CPU Unit Motion Control User's Manual (Cat. No. W507)* or *NY-series Industrial Panel PC / Industrial Box PC Motion Control User's Manual (Cat. No. W559)*.



Precautions for Correct Use

- If you are using an NX701 Controller, before selecting the priority-5 periodic task (MC2) for motion control in the **Axis Group Basic Settings**, register the priority-5 periodic task in the task settings. Refer to *5-9-1 Registering Tasks* on page 5-125 for the task registration procedure in the task settings.
- With an NX701 Controller, set the same task for motion control in the **Axis Basic Settings** for the configuration axes and for motion control in the **Axis Group Basic Settings**. An error will occur if they are not the same.
- With an NX701 Controller, if you need to change the tasks assigned for motion control in the **Axis Basic Settings** of the configuration axes and the tasks assigned to the slaves and Units that are assigned to the configuration axes, you can do so at the same time by changing the task assigned for motion control in the **Axis Group Basic Settings**.

When you change the task that is set for motion control in the **Axis Group Basic Settings**, a dialog box is displayed asking whether to change the tasks that are set for motion control in the **Axis Basic Settings** of the configuration axes.

Yes Button:	The tasks that are set for motion control for the configuration axes are automatically changed. In the same way, the tasks that are set in the task settings of the slaves and Units assigned to the configuration axes are also changed.
No Button:	Only the task that is set for motion control in the Axis Group Basic Settings is changed. In this case, a mismatch error will occur for the task that is set for motion control in the Axis Group Basic Settings and the tasks that are set for motion control in the Axis Basic Settings in the configuration axes.
Cancel Button:	The change is canceled.

5-7-5 Exporting and Importing Axes Group Settings

You can export axes group settings to an XML file and import the file into a different project. All items displayed in the Axes Group Parameter Settings tab page are subject to export and import.

To edit an exported file with Sysmac Studio or to create an import file using software other than Sysmac Studio, refer to the XML schema in the paths below. Help provides the information on the XML file format.

			Location (Default installation)	File
XML schema	For Sysmac Studio 32-bit application	For 32-bit OS	C:\Program Files\OMRON\Sysmac Studio\Sample\Motion Control Setup\Axes Group Settings	AxesGroupSettingFile-Schema_Rev{Format Version}.xsd
		For 64-bit OS	C:\Program Files (x86)\OMRON\Sysmac Studio\Sample\Motion Control Setup\Axes Group Settings	
	For Sysmac Studio 64-bit application		C:\Program Files\OMRON\Sysmac Studio\Sample\Motion Control Setup\Axes Group Settings	
Help	Sysmac Studio 32/64-bit application		C:\Program Files\OMRON\Sysmac Studio\Help	AxesGroupSettingsXmlFileInformation.html



Version Information

The axes group setting export and import functions are available in projects for the NJ/NX/NY series CPU Units with version 1.14 or later.

How to Export Axes Group Settings

- 1 Right-click **Axes Group Settings** under **Configurations and Setup – Motion Control Setup** in the Multiview Explorer and select **Export** from the menu.

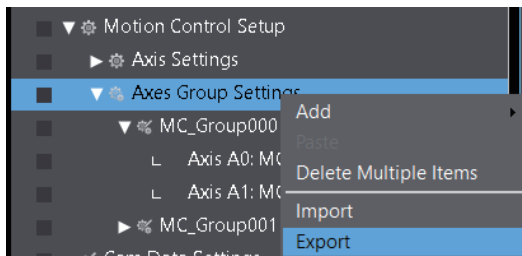

The **Axes group setting Export** dialog box appears.

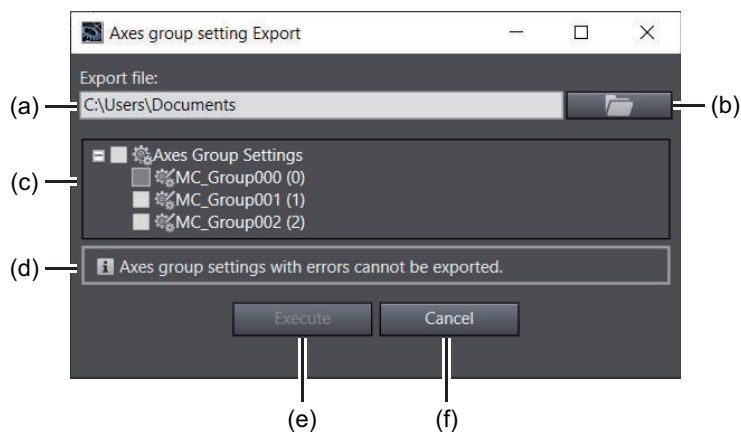

No.	Item	Description
(a)	Export file	This box shows the path of the file you export.

No.	Item	Description
(b)	File selection dialog box button	You can specify the path of the file to export.
(c)	Axes group settings	You can select axes group settings to export. If there is an error in an axes group setting, you cannot select it.
(d)	Error message	This message will appear when there is an error in an axes group setting.
(e)	Execute button	This button executes the export process for axes group settings.
(f)	Cancel button	This button stops exporting axes group settings and closes the dialog box.

2 Click the file selection dialog box button.

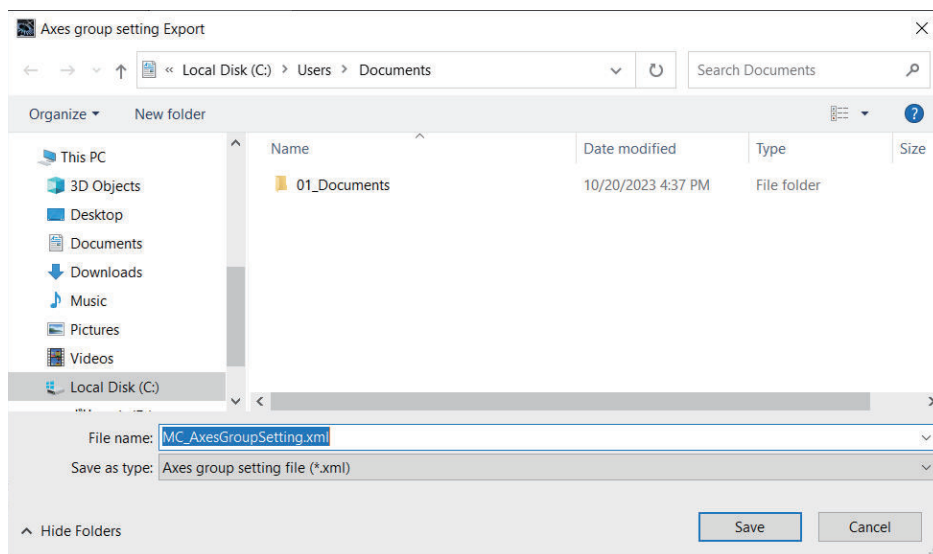

The file selection dialog box appears.

3 In the file selection dialog box, specify the path of the file you export, and then click the **Save** button.

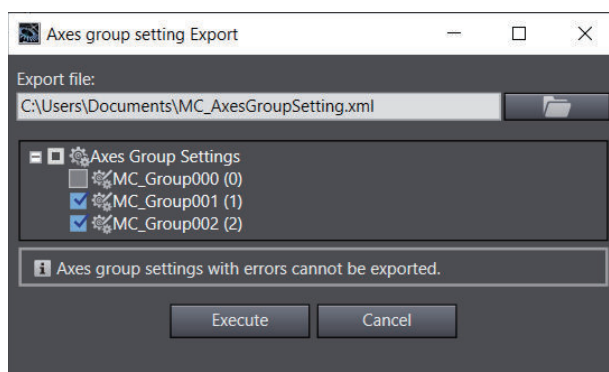

You will be back to the **Axes group setting Export** dialog box. The **Export file** box shows the file path you have selected in the file selection dialog box.

4 Select an axes group setting you export, and click the **Execute** button.

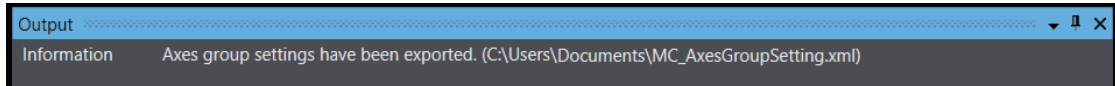

The Output tab page shows the export result.

How to Import Axes Group Settings

- 1 Right-click **Axes Group Settings** under **Configurations and Setup – Motion Control Setup** in the Multiview Explorer and select **Import** from the menu.

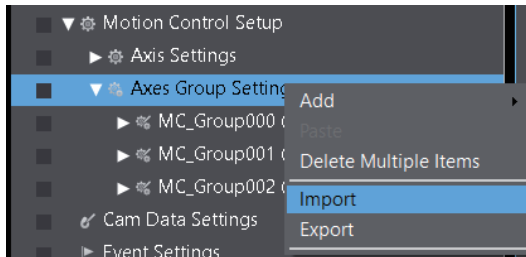

The confirmation message appears.

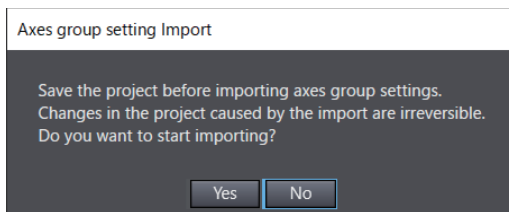

- 2 Click the **Yes** button to display the file selection dialog box.

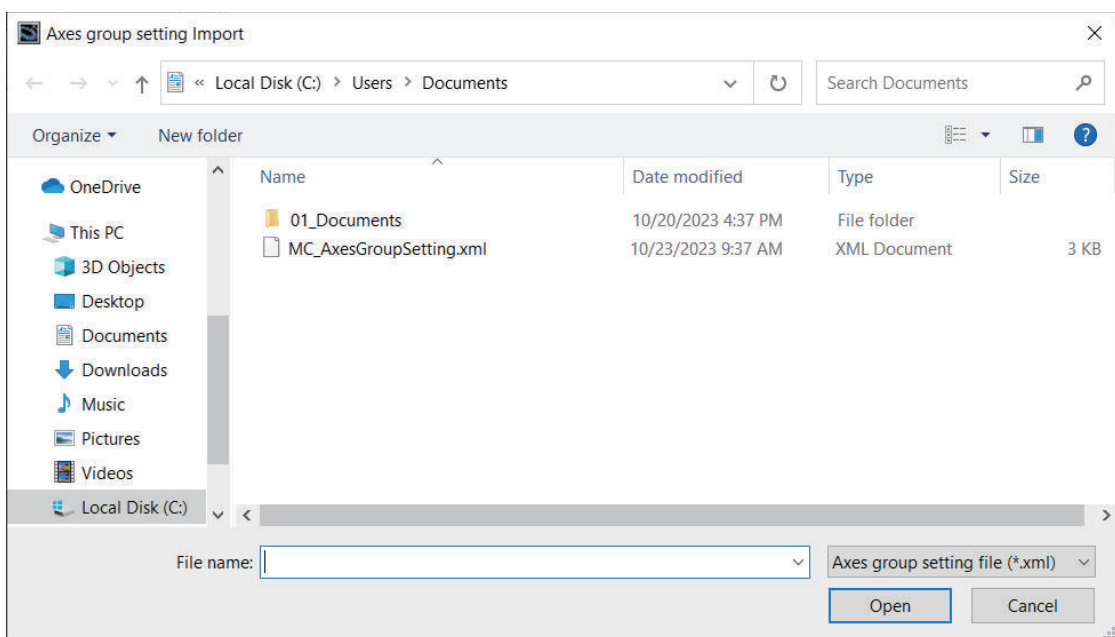

- 3 In the file selection dialog box, select the axes group setting file you import, and then click the **Open** button.
- 4 When the completion message appears, click the **OK** button.

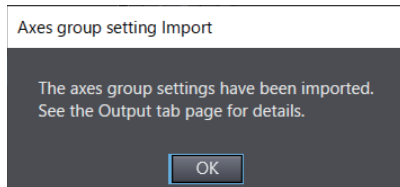

The Output tab page shows the import results.

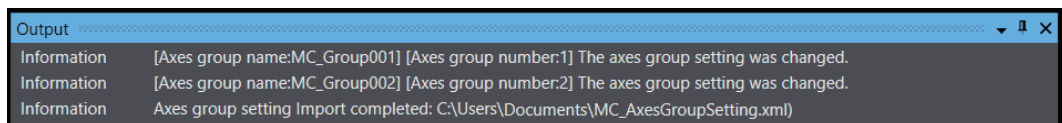

Precautions for Correct Use

Check the system operation with the imported axes group settings carefully before the actual operation.

5-7-6 Deleting Multiple Axes Group Settings

You can delete multiple axes group settings all at once by selecting them on the dialog box.



Version Information

This function is available in projects for the NJ/NX/NY series CPU Units with version 1.05 or later.

How to Delete Multiple Axes Group Settings

- 1 Right-click **Axes Group Settings** under **Configurations and Setup – Motion Control Setup** in the Multiview Explorer and select **Delete Multiple Items** from the menu.

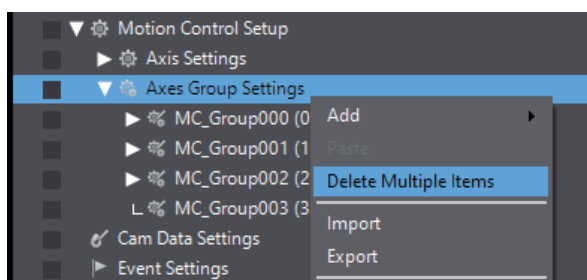

The **Delete Multiple Axes Group Settings** dialog box appears.

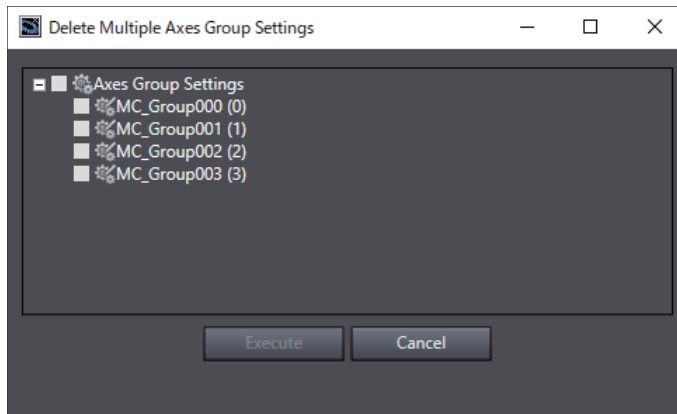

- 2** Select axes group settings to delete and click the **Execute** button.
The confirmation message appears.

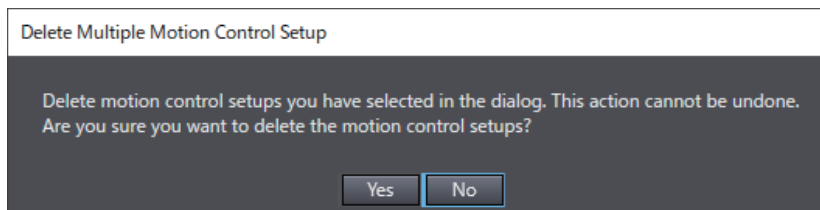

- 3** Click the **Yes** button.
The selected axes group settings are deleted.

5-8 Cam Data Settings

The cam data settings are used to create electronic cam data.

You can create more than one cam profile containing the cam data settings.

The cam table defines the relationship of the phases of the master axis and the corresponding displacements in the slave axis for the electronic cam. “Cam data” refers to one master axis phase and the corresponding slave axis displacement in the cam table.

When you build the project for the Controller, a cam table is created according to the cam data settings.

The cam profiles that you build from the cam data settings contain the cam data settings and a cam table.

Of the cam data settings in the cam profile, the data that is required for the Generate Cam Table instruction to create a cam table is called the cam definition.

5-8-1 Registering Cam Data Settings

- 1 Right-click **Cam Data Settings** under **Configurations and Setup** in the Multiview Explorer and select **Add - CamProfile** from the menu.

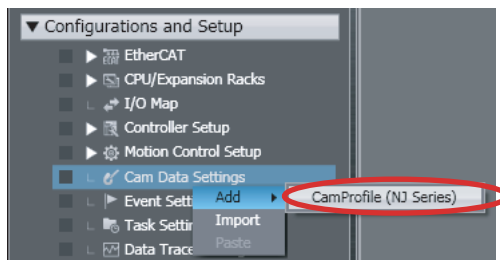

The *CamProfile0* cam profile is added under the Cam Data Settings.

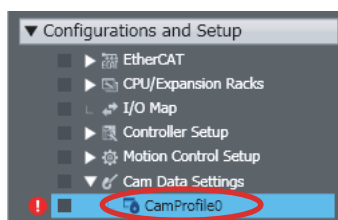

5-8-2 Editing Cam Data Settings

- 1 Starting the Cam Editor
Right-click the cam profile to edit and select **Edit** from the menu.

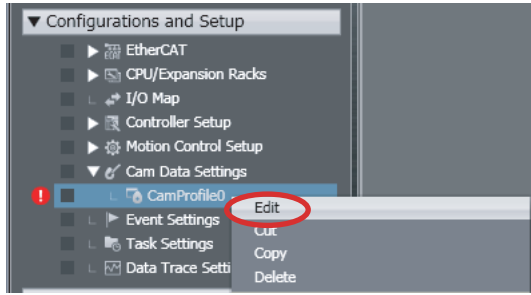

The Cam Editor starts.

You must use the Cam Editor to set the cam table properties and cam nodes that are necessary to create a cam table.

2 Setting Cam Table Properties

Set the properties of the cam table.

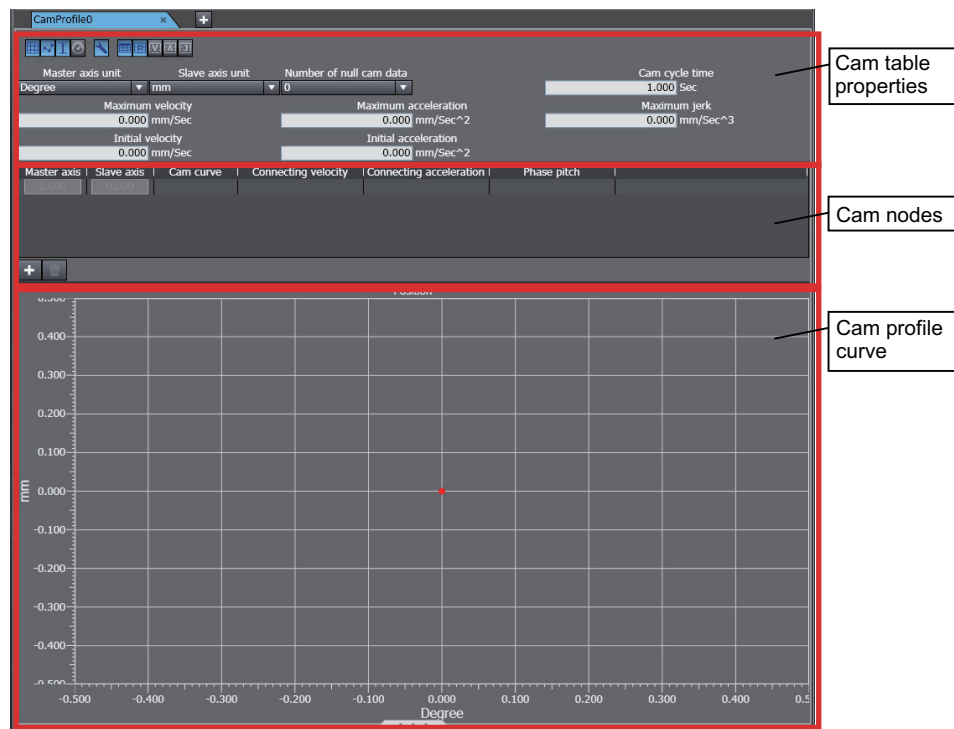

3 Registering Node Points (Defining Curves)

For the cam nodes, enter the node points that the cam operation must pass through. (Enter the master axis phase and the corresponding slave axis displacement for each node point.)

- Click the Add Button (+).



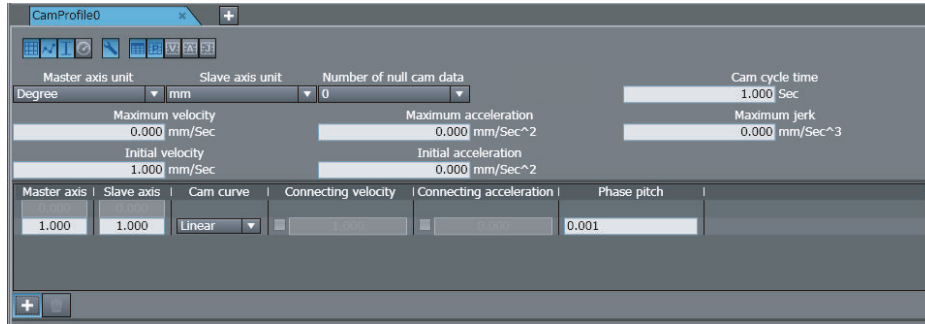

- A node point is added.

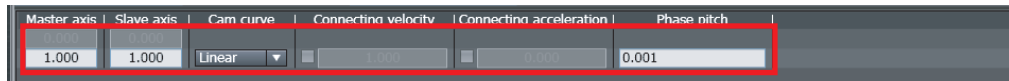

- Enter the phase of the master axis and the displacement of the slave axis and then specify the shape of the curve.

Note Enter the phase of the master axis and the displacement of the slave axis before you add the next node point.

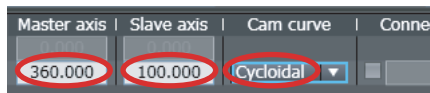

The cam profile curve is drawn on the graph.

The cam profile curve is displayed as a graph of the cam operation for the cam table properties and the cam nodes that you set.

The graphs that display the velocity, acceleration rate, and jerk for a cam operation when the master axis is at a constant velocity are called the velocity graph, acceleration graph, and jerk graph.

The velocity, acceleration rate, and jerk are calculated based on the settings of the cam cycle time, cam table properties, and cam nodes.

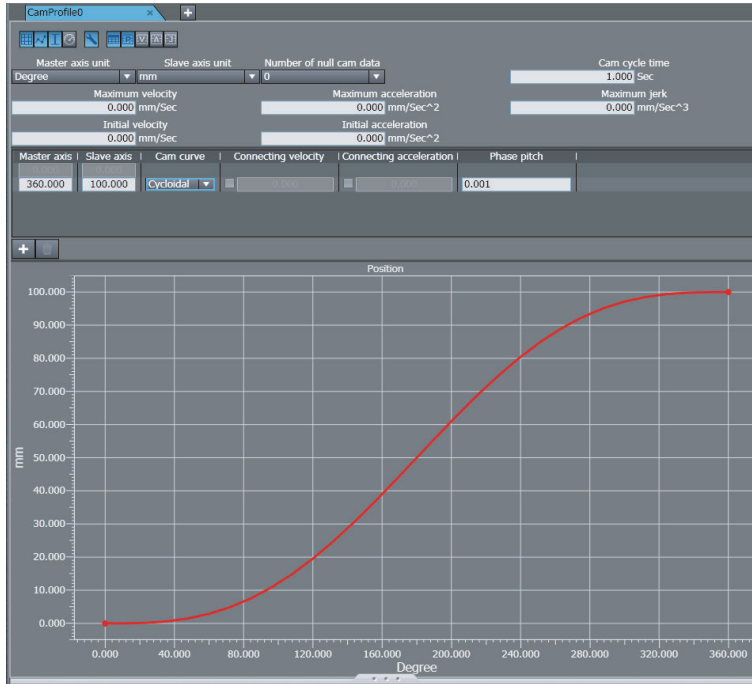

4 Editing Node Points

You can use the following two methods to edit node points.

- a) Entering the Phase and Displacement Directly
Enter the phase, displacement, curve, and phase pitch for the node.
- b) Moving the Points on the Graph with the Mouse

Enable the position graph display on the toolbar () to display the graph.

Click the pointers that represent the start and end points of the curve () and drag them to the positions you want.

Note 1 If you drag a point to a location where it cannot be moved, the curve is not changed and only the pointer moves.

2 You can perform this same operation for the velocity graph, acceleration graph, and jerk graph.



Additional Information

- Enter the phases of the master axis in ascending order.
- You can register up to 360 node points. This includes the 0.00 node point, which is registered by default.

The items that are set are described in the following tables.

● Cam Table Properties

Parameter	Range/unit	Description
Master axis unit	deg, inch, mm, pulse, μm , or nm	Set the unit to use for the master axis.
Slave axis unit	deg, inch, mm, pulse, μm , or nm	Set the unit to use for the slave axis.

Parameter	Range/unit	Description
Number of null cam data	0, 10, 50, 100, 500, 1000, 5000, or 10000	Set a value to insert data with the phase of the master axis and the displacement of the slave axis set to zero after the end point of the cam.
Cam cycle time	s	Set the time for one cam cycle.
Maximum velocity	mm/s	Set the maximum velocity for the slave axis. The set value is displayed on the velocity graph as a blue dotted line.
Maximum acceleration	mm/s ²	Set the maximum acceleration for the slave axis. The set value is displayed on the acceleration graph as a blue dotted line.
Maximum jerk	mm/s ³	Set the maximum jerk for the slave axis. The set value is displayed on the jerk graph as a blue dotted line.
Initial velocity	mm/s	Displays the velocity when the phase of the master axis is 0. If a phase of 0 is followed by a polynomial 3, polynomial 5, or free curve, you can specify the initial velocity.
Initial acceleration	mm/s ²	Displays the acceleration rate when the phase of the master axis is 0. You can specify the initial acceleration rate when a polynomial 5 curve is connected after a phase of 0.

● Cam Nodes

Item	Description
Master axis	Enter the phase of the master axis.
Slave axis	Specify the displacement of the slave axis for the master axis.
Cam curve	Specify the curve for the connection to the previous node point. Refer to <i>Cam Curves</i> under <i>Cam Nodes</i> on page 5-109, below, for the types of curves.
Connecting Velocity	You can specify the velocity for the connecting section between a polynomial 3, polynomial 5, or free curve and to the next curve. Use this setting for smooth connections between curves.
Connecting Acceleration	You can specify the acceleration rate for the connecting section between a polynomial 5 curve and the next curve. Use this setting for smooth connections between curves.
Phase Pitch	The phases of the cam profile curve are divided by the specified pitch to create the cam data. There must be no more than 65,535 nodes in the cam data. Division is performed when the project is built.

Cam Curves

Curve shape	Connection condition specification	Main applications
Constant	Not possible.	Used to create a dwell range between a block start point and block end point.
Straight Line	Not possible.	Used to move at a constant velocity.
Parabolic	Not possible.	Used to accelerate/decelerate at a constant rate or to restrict the maximum acceleration/deceleration rate.
Modified Constant Velocity	Not possible.	Used for medium-velocity, high-load equipment.
Modified Trapezoid	Not possible.	Used for high-velocity, low-load equipment.
Modified Sine	Not possible.	Used for high-velocity, medium-load equipment. Used to reduce the effect on the motor for load variations.
Cycloidal	Not possible.	Used to suppress residual vibration even for a high acceleration rate.
Trapezoid	Not possible.	Used to suppress residual vibration even for a high-velocity, high-load equipment.









Curve shape	Connection condition specification	Main applications
Reverse-Trapezoid	Not possible.	Used to accelerate smoothly.
Simple Harmonic	Not possible.	Used for low-velocity motion or non-stopping operation.
Double Harmonic	Not possible.	Used to accelerate relatively smoothly or for one-dwell motion.
Reverse-Double Harmonic	Not possible.	Used to decelerate relatively smoothly.
NC2 Curve	Not possible.	Used to reduce the effect on the motor for load variations. Used to suppress residual vibration.
Polynomic 3	Possible (Connecting Velocity).	Used to specify the velocity between a block start point and block end point.
Polynomic 5	Possible (Connecting Velocity and Connecting Acceleration).	Used to specify the velocity and acceleration rate between a block start point and block end point.
Free Curve	Possible (Connecting Velocity).	Used to accelerate/decelerate smoothly. Used to specify the velocity between a block start point and block end point.





Additional Information

- You can use only a free curve, straight line, or constant curve before and after a free curve.
- If free curves are connected to each other, you can specify a connection condition only for the last point.

● Graph View List

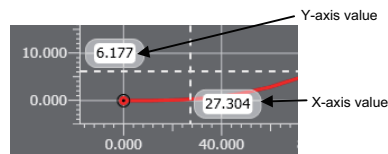
Icon	Description
	Shows or hides the grid on the graph.
	Shows or hides the marker at the end of the graph.
	Shows or hides the cursors and value-at-cursor display.
	Shows or hides the maximum values for the velocity, acceleration/deceleration rate, and jerk on the graph. These values are indicated by dotted blue lines.
	Shows or hides the properties.
	Shows or hides node points.
	Shows or hides the position graph.
	Shows or hides the velocity graph.
	Shows or hides the acceleration rate (deceleration rate) graph.



Icon	Description
	Shows or hides the jerk graph.
	Shows or hides the plot of the superimposed cam data when displaying superimposed graphs. This icon can be used only when superimposed graphs are displayed.

● Graph Operations

Rotate the mouse wheel to increase or decrease the scale.

- Rotate the mouse wheel in the center of the graph to zoom in or zoom out of the entire graph.
- Move your mouse over the X or Y axis and rotate the mouse wheel to increase or decrease the scale of only the X or Y axis.



Precautions for Correct Use

You can use a straight line or straight line with constant displacement only before and after a free form curve.

5-8-3 Procedure to Transfer Cam Data Settings

Use the synchronization operation to transfer the cam data settings to the Controller.

Refer to *Synchronizing (Uploading/Downloading after Automatic Verification)* on page 7-127 for more information on synchronizing.

Use the following procedure.

- 1 Go online with the Controller.
- 2 Select **Synchronization** from the **Controller** Menu.
The Synchronization Window is displayed.
- 3 Select the cam profile to transfer under **Cam Data Settings** in the Synchronization Window and then click the **Transfer To Controller** Button.
The transfer starts.

5-8-4 Importing Cam Data Settings

You can import cam data settings from a CSV file.

- 1 Right-click **Cam Data Settings** under **Configurations and Setup** in the Multiview Explorer and select **Import** from the menu.

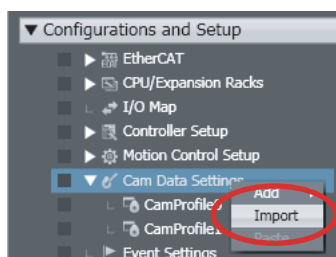

The **Open** Dialog Box is displayed.

- 2 Select the CSV file to import, and then click the **Open** Button.

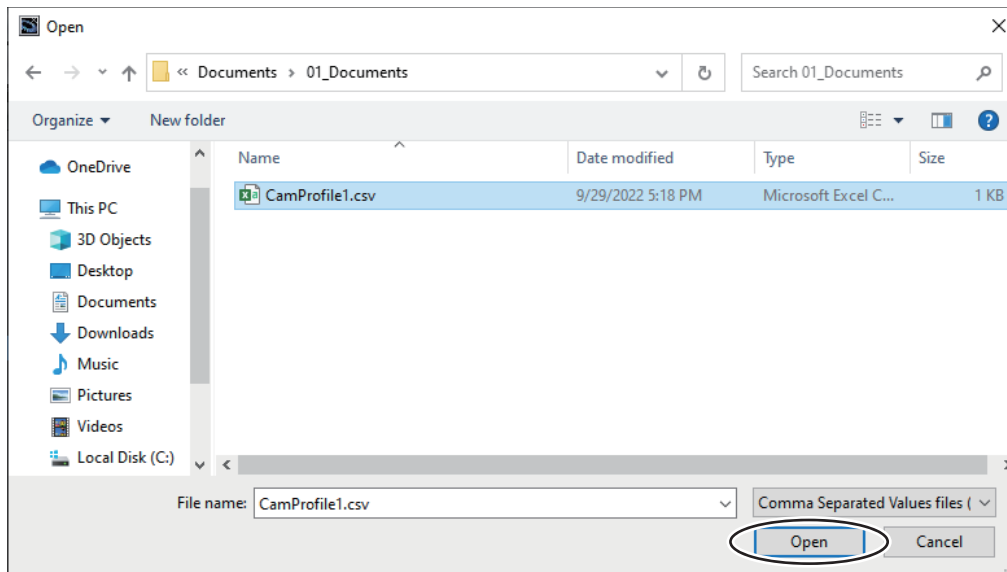

The imported cam profile is registered under **Cam Data Settings** with a serial number added.

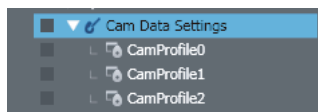

Precautions for Correct Use

To import cam data settings, use a CSV file encoded with UTF-8 character codes.

5-8-5 Exporting Cam Data Settings

You can export cam data settings to a CSV file.

- 1 Right-click the cam data settings to export and select **Export** from the menu.

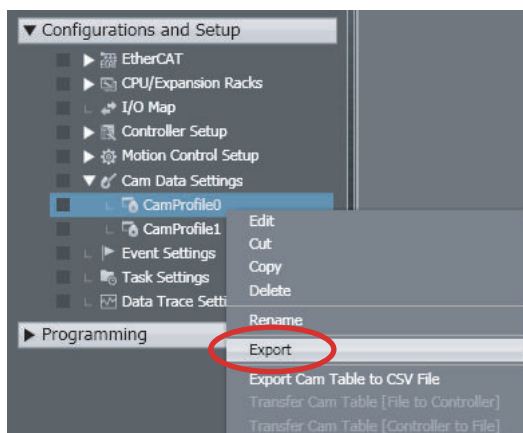

The **Save** Dialog Box is displayed.

- Specify the file location and name, and then click the **Save** Button.

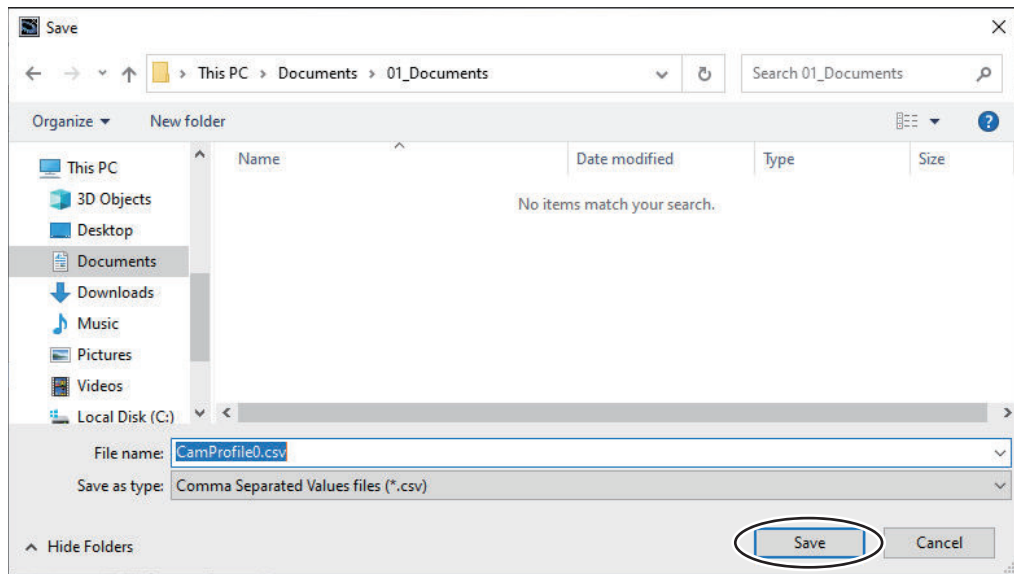

The cam data settings are saved in CSV format.



Precautions for Correct Use

The exported CSV file of cam data settings is encoded in UTF-8 character codes.

5-8-6 Exporting Cam Tables

You can export a cam table to a CSV file.

- Right-click the cam profile for the cam table to export and select **Export Cam Table to CSV File** from the menu.

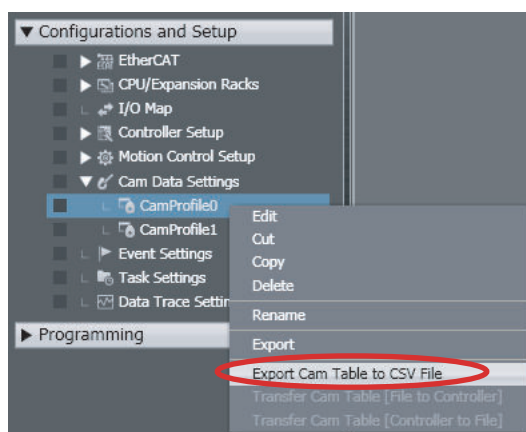

The **Save** Dialog Box is displayed.

- Specify the file location and name, and then click the **Save** Button.

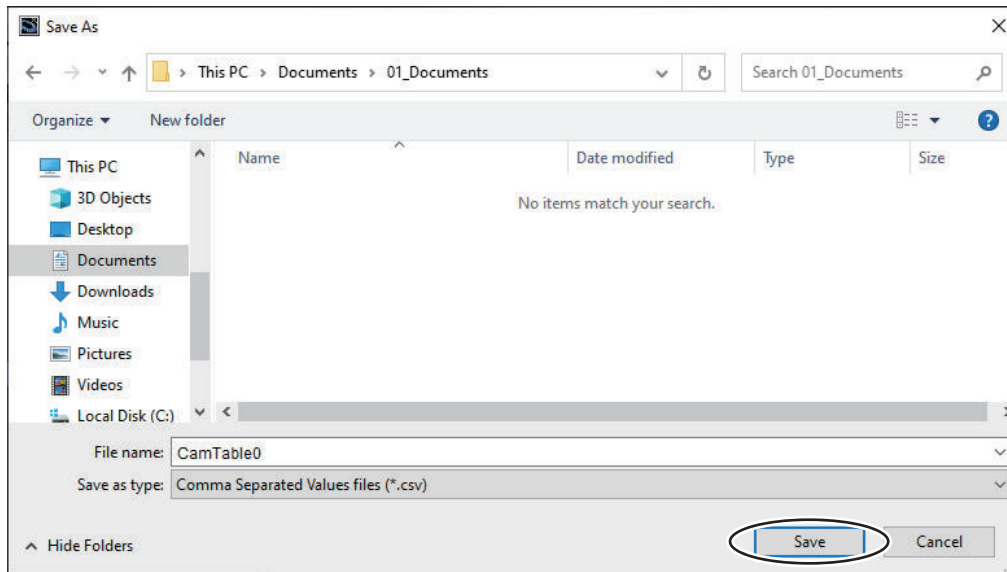

Precautions for Correct Use

To export a cam table, you must first build the project.

5-8-7 Transferring Cam Tables from the Controller to Files

You can save a cam table in the Controller to a CSV file.

- 1 Right-click the cam profile for the cam table to export and select **Transfer Cam Table [Controller to File]** from the menu.

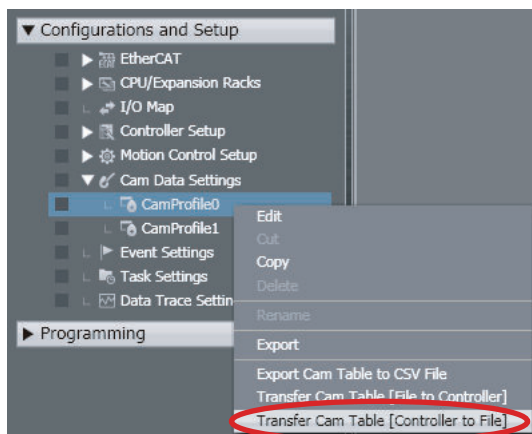

The **Save** Dialog Box is displayed.

- 2 Specify the file location and name, and then click the **Save** Button.

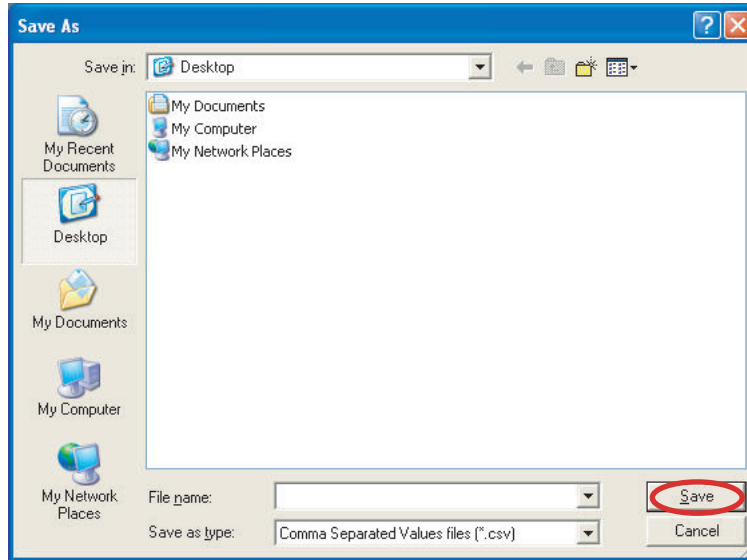

The cam table from the Controller is saved in a CSV file.

5-8-8 Transferring Cam Tables from Files to the Controller

You can transfer a cam table that is saved in a CSV file to update the contents of a cam table that is already in the Controller.

- 1 Right-click the cam profile for the cam table to import and select **Transfer Cam Table [File to Controller]** from the menu.
The **Open File** Dialog Box is displayed.
- 2 Specify the name of the file to transfer, and then click the **OK** Button.
- 3 To enable the cam table that was transferred, reset the Controller or cycle the power supply to the Controller after you transfer the cam table.



Precautions for Correct Use

- You must synchronize with the Controller before you can transfer a cam table from a file to the Controller. Refer to *Synchronizing (Uploading/Downloading after Automatic Verification)* on page 7-127 for more information on synchronizing.
- The number of cam data in the cam table that is transferred from a file to the Controller must be the same as the number of cam data in the cam table in the Controller.
- The cam table that is transferred from a file to the Controller is not saved in the project on the Sysmac Studio.
- You cannot use the Controller synchronization function to transfer to the project on the Sysmac Studio, a cam table that was transferred from a file to the Controller. To save a cam table in the Controller to a file, select **Transfer Cam Table [Controller to File]** from the menu.
- If you perform verification after transferring a cam table from a file to the Controller, an inconsistency is not detected even if the contents of the cam table differs from the cam data settings.
- If you synchronize the Controller data after you transfer a cam table from a file to the Controller, you will need to transfer the cam table again.
- You cannot transfer a cam table from a file to the Controller when performing a simulation for debugging.

5-8-9 Superimposing Cam Tables

You can superimpose the cam table from a CSV file on the cam profile curve position graph that is currently displayed. This allows you to visually confirm the differences between the cam profile curve and the cam table in the CSV file.

- 1 Right-click the cam profile that is currently displayed and select **Superimpose Cam Table** from the menu.

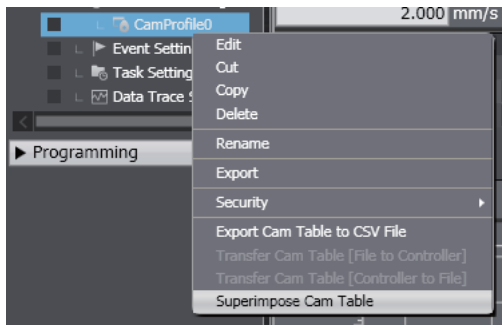

The **Open File** Dialog Box is displayed.

- 2 Select the CSV file that contains the cam table to superimpose, and then click the **Open** Button.

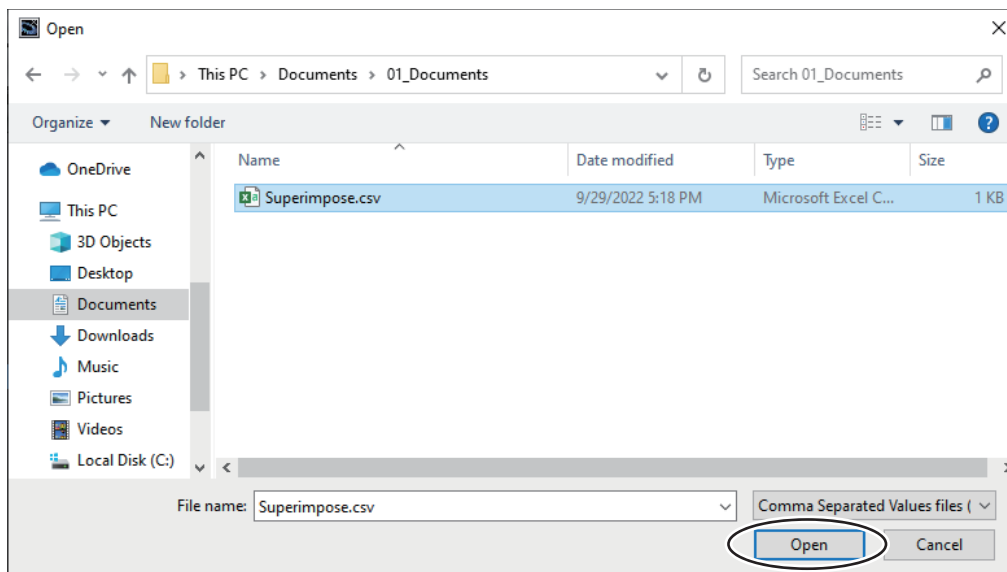

The cam table from the CSV file is superimposed on the currently displayed position graph.

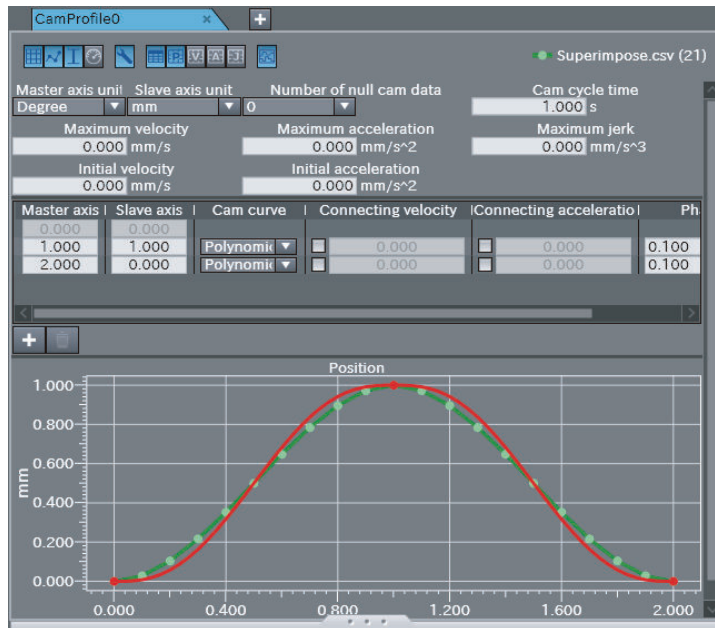

Red: Currently displayed cam profile curve

Green: Cam table from CSV file

5-8-10 Registering Cam Definitions

This section describes how to register and delete cam definitions.

A cam definition is the data that must be extracted from a cam profile in order to create a cam table. It is used to change a cam table from a program.

When you register the cam definition with a cam profile, the cam definition variables are automatically created. The cam definition variables are used by the Generate Cam Table instruction to enable a program to create a cam table.

“Cam definition variables” is a generic name for the cam property variable and cam node variable.

For an outline of creating cam tables, refer to the *NJ/NX-series CPU Unit Motion Control User's Manual (Cat. No. W507)* or *NY-series Industrial Panel PC / Industrial Box PC Motion Control User's Manual (Cat. No. W559)*.

For details on the cam definition variables and Generate Cam Table instruction, refer to the *NJ/NX-series Motion Control Instructions Reference Manual (Cat. No. W508)* or *NY-series Motion Control Instructions Reference Manual (Cat. No. W561)*.



Version Information

A CPU Unit with unit version 1.08 or later and Sysmac Studio version 1.09 or higher are required to use this function.

● Creating Cam Definitions

When you create a cam definition, it inherits the settings of the cam profile. The cam definition variables that are created from the cam definition are automatically added to the global variables.

The cam definition settings are stored separately from the cam profile settings in the project.

- 1 Right-click the cam profile under **Configurations and Setup - Cam Data Settings** in the Multi-view Explorer and select **Create Cam Definition** from the menu.

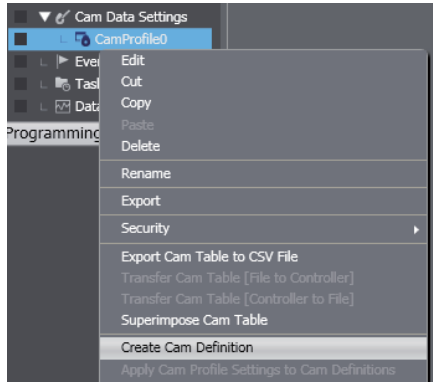

The cam definition is registered below the corresponding cam profile and displayed as follows:
`Cam_definition_name(Cam_property_variable_name,Cam_node_variable_name)`

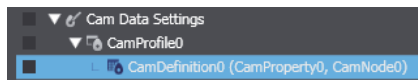

The cam property variable and cam node variable are registered in the global variable table. You can change the attributes of the cam property variable and cam node variable from the Cam Definition Tab Page. You cannot edit them in the global variable table.



Precautions for Correct Use

The cam definition variables are created with the Retain attribute set to *Retained*. This attribute cannot be changed for cam definition variables. If the Controller's limit for the number or data size of retained variables is exceeded when a cam definition is created, creating the cam definition fails. Refer to the *NJ/NX-series CPU Unit Software User's Manual (Cat. No. W501)* or *NY-series Industrial Panel PC / Industrial Box PC Software User's Manual (Cat. No. W558)* for information on the limits to the number or data size of retained variables.

● Editing Cam Definitions

Use the following procedure to edit the cam definition data for cam definition variables.

- 1 Right-click the cam definition to edit in the Multiview Explorer and select Edit from the menu.

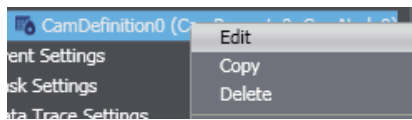

The Cam Definition Tab Page is displayed.

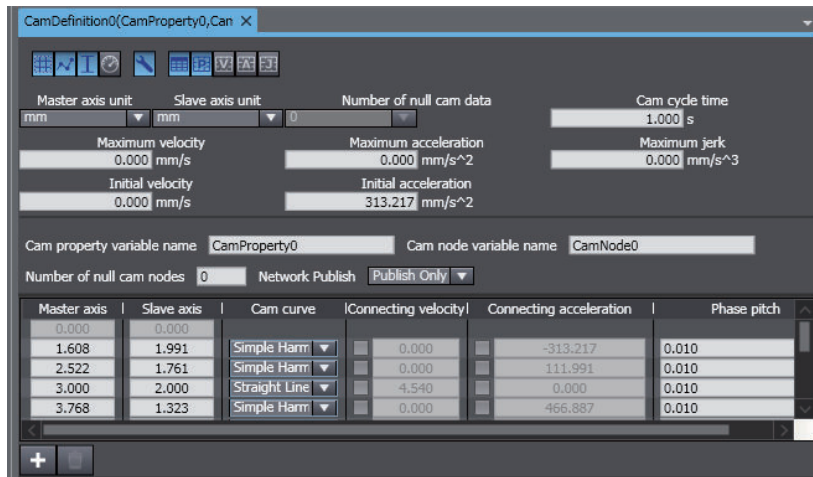

2 You can edit the settings of the cam property variable and cam node variable.

Here, we describe the settings for the cam definition variables.

For the items that have the same names as the settings in the cam profile, refer to *5-8-2 Editing Cam Data Settings* on page 5-105.

Cam Property Variable

Items That Correspond to Members

Item	Description	Set values	Remarks
Cam cycle time	Set the time for one cam cycle.	---	
Initial velocity	Displays the velocity when the phase of the master axis is 0.	---	You can specify the initial velocity if polynomial 3 or polynomial 5 is set as the curve for the next cam node after the start node. This item is set automatically for other curves.
Initial acceleration	Displays the acceleration rate when the phase of the master axis is 0.	---	You can specify the initial acceleration if polynomial 5 is set as the curve for the next cam node after the start node. This item is set automatically for other curves.

Items That Correspond to Attributes

Item	Description	Set values	Remarks
Cam property variable name	Set the name of the cam property variable.	---	You change the variable name here, and not in the global variable table.
Network publish	Set the Network Publish attribute of the cam property variable. The same setting is used for the cam node variable.	Do not publish. Publish Only (default) Input Output	You change this attribute here, and not in the global variable table.

Note You cannot change any attributes of the variables that are not given above.

Cam Node Variable

Items That Correspond to Members

Item	Description	Set values	Remarks
Cam node (node point)	Register a node point. The total of the number of null cam nodes and node points must be 360 or less.	---	Refer to <i>5-8-2 Editing Cam Data Settings</i> on page 5-105 for the procedure to register node points.
Master axis	Enter the phase of the master axis.	---	
Slave axis	Specify the displacement of the slave axis for the master axis.	---	
Cam curve	Specify the curve for the connection to the previous node point. Refer to <i>Cam Curves under Cam Nodes</i> on page 5-109 for the types of curves.	---	You cannot select a free curve for the cam curve in a cam definition.
Connecting velocity Check Box	Select this check box when polynomial 3 or polynomial 5 is selected to enable specifying the connecting velocity.	---	
Connecting velocity	You can specify the velocity for the connecting section between a polynomial 3 or polynomial 5 curve and the next curve. Use this setting for smooth connections between curves.	---	A value is set automatically for curves other than polynomial 3 or polynomial 5.
Connecting acceleration Check Box	Select this check box when polynomial 5 is selected to enable specifying the connecting acceleration.	---	
Connecting acceleration	You can specify the acceleration rate for the connecting section between a polynomial 5 curve and the next curve. Use this setting for smooth connections between curves.	---	A value is set automatically for curves other than polynomial 5.
Phase pitch	The phases of the cam profile curve are divided by the specified pitch to create the cam data. There must be no more than 65,535 nodes in the cam data.	---	

Items That Correspond to Attributes

Item	Description	Set values	Remarks
Cam node variable name	Set the cam node variable name.	---	You change the variable name here, and not in the global variable table.
Number of null cam nodes	Set the number of data elements that are reserved in the cam node variable. The total of the number of null cam nodes and node points must be 360 or less.	0 to 359	The total of the number of null cam nodes and node points determines the array size of the cam node variable.

Item	Description	Set values	Remarks
Network publish	Set the Network Publish attribute of the cam node variable. The same setting is used for the cam property variable.	Do not publish. Publish Only (default) Input Output	You change this attribute here, and not in the global variable table.

Note You cannot change any attributes of the variables that are not given above.

The master axis unit setting, slave axis unit setting, maximum velocity, and maximum acceleration are used only to display the cam profile curve graph.

The number of null cam data is always set to 0. You cannot change it in the cam definition. Use the cam profile settings to change the number of null cam data.



Precautions for Correct Use

The cam data that is created by the Generate Cam Table instruction is stored in the cam data variable. The array size of the cam data variable is determined by the settings of the cam profile.

Depending on the settings of the number of node points and phase pitch of the cam node variable, the size of the cam data that is created by the Generate Cam Table instruction may exceed the array size of the cam data variable that was set with the cam profile, resulting in an execution error for the instruction.

Ensure that there is a sufficient number of null cam data in the cam profile settings so that the cam data size created by the Generate Cam Table instruction does not exceed the size of the cam data variable.

● Deleting Cam Definitions

- 1** Right-click the cam definition to delete in the Multiview Explorer and select Delete from the menu.
A confirmation dialog box is displayed.
- 2** Click the Yes Button in the confirmation dialog box.
The cam definition is deleted and the cam definition variables registered in the global variable table are also deleted.

5-8-11 Transferring Cam Definitions

This section describes how to transfer cam definitions and how to read and write cam definition values.

● Transferring Cam Definitions

Use the synchronization operation to transfer a cam definition and cam definition variables to the Controller.

Refer to *Synchronizing (Uploading/Downloading after Automatic Verification)* on page 7-127 for details on synchronization.

Use the following procedure.

- 1** Go online with the Controller.

- 2 Select **Synchronization** from the **Controller** Menu.
The Synchronization Window is displayed.
- 3 Select the cam definition to transfer under **Cam Data Settings** in the Synchronization Window and then click the **Transfer To Controller** Button.
The transfer starts.
When the transfer is completed, a dialog box to transfer the cam definition settings is displayed.
- 4 Click the **Yes** Button in the dialog box.
The cam definition settings are written to the cam definition variables.



Precautions for Correct Use

The cam definition settings are not applied to the cam definition variables merely by transferring the cam definition and cam definition variables to the Controller. After you transfer the cam definition, you must perform the procedure in *Writing Cam Definition Values* on page 5-122.

● Writing Cam Definition Values

After you transfer the cam definition and cam definition variables to the Controller, you must write the cam definition settings to the cam definition variables in the Controller.

- 1 While the Controller is online, right-click the cam definition in the Multiview Explorer and select **Transfer Cam Definition Values to Controller** from the menu.

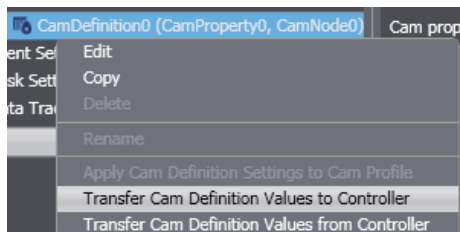

A confirmation dialog box is displayed.

- 2 Click the **Yes** Button in the confirmation dialog box.
The cam definition settings are written to the cam definition variables in the Controller.



Additional Information

If you right-click **Cam Data Settings** or a cam profile in the Multiview Explorer and select the transfer menu command, you can transfer all of the cam definition values under the selected item to the Controller at the same time.

● Reading Cam Definition Values

You can read cam definition variable values that were changed on the Controller to the cam definition.

- 1 While the Controller is online, right-click the cam definition in the Multiview Explorer and select **Transfer Cam Definition Values from Controller** from the menu.

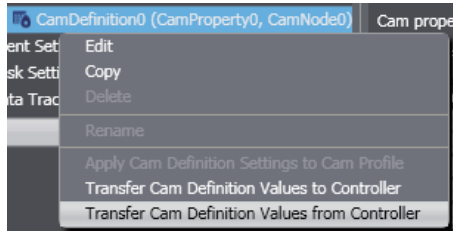

A confirmation dialog box is displayed.

- 2 Click the **Yes** Button in the confirmation dialog box.
The cam definition variable values on the Controller are read to the cam definition.



Additional Information

- If you right-click **Cam Data Settings** or a cam profile in the Multiview Explorer and select the transfer menu command, you can transfer all of the cam definition values under the selected item from the Controller at the same time.
- The values of the initial velocities, initial accelerations, connecting velocities, and connecting accelerations in the cam profile and cam definition are automatically calculated according to the cam node settings and curve types. If you read the values in the cam definition variables after you change from an HMI an initial velocity or initial acceleration in the cam property variable or a connecting velocity or connecting acceleration in the cam node variable in the Controller, a different value is sometimes displayed on the HMI and Sysmac Studio depending on the cam node settings and curve type.

5-8-12 Updating Cam Definition Settings

This section describes how to apply cam definition settings to the cam profile and how to apply the cam profile settings to the cam definition.

● Applying Cam Profile Changes to the Cam Definition

If you change the source cam profile settings after you create the cam definition, you can apply the changes to the cam definition.

- 1 Right-click the cam profile in the Multiview Explorer and select **Apply Cam Profile Settings to Cam Definitions** from the menu.

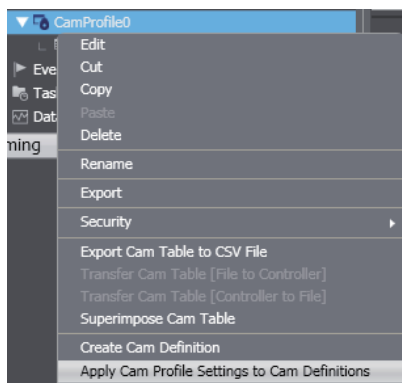

A confirmation dialog box is displayed.

- 2 Click the **Yes** Button in the confirmation dialog box.

The settings of the cam profile are applied to all cam definitions below the cam profile.

● Applying Cam Definition Changes to the Cam Profile

Use the following procedure to apply the cam definition settings to the cam profile.

- 1** Right-click the cam definition in the Multiview Explorer and select **Apply Cam Definition Settings to Cam Profile** from the menu.

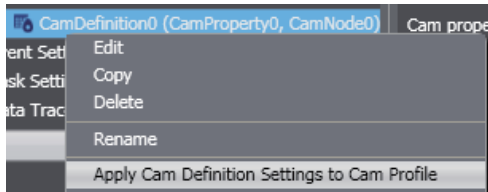

A confirmation dialog box is displayed.

- 2** Click the **Yes** Button in the confirmation dialog box.
The cam definition settings are applied to the cam profile.

5-9 Task Settings

- Task Settings

Programs are executed in tasks in an NJ/NX/NY-series Controller.

Task settings define the execution period, the execution timing, the programs executed by the task, the I/O refreshing performed by the task, and which variables to share between tasks.

5-9-1 Registering Tasks

Use the following procedure to register a task to execute programs.

1 Double-click **Task Settings** under **Configurations and Setup** in the Multiview Explorer.

2 Click the **Task Settings** Button () in the Edit Pane.

3 Click the **+** Button to add a task and enter the task type.

The primary periodic task (execution priority 4) is registered by default and cannot be deleted. You can register periodic tasks and event tasks.

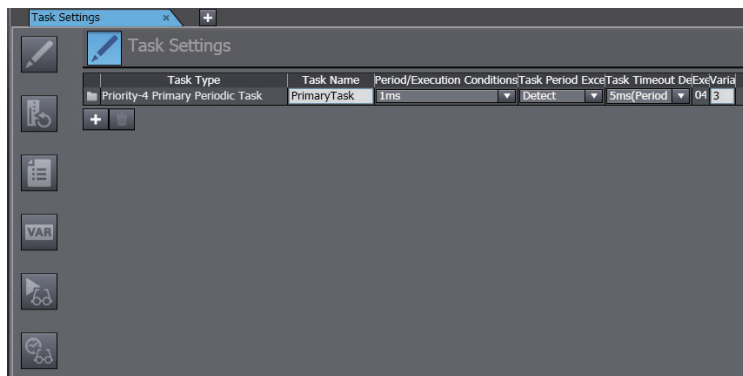

Selected item	Maximum number of tasks
Priority-5 periodic task* ¹	1
Priority-16* ² , -17, or -18 periodic task	1 periodic task with each priority
Priority-8 or -48 event task* ³	A total of 32 event tasks

*1. This can be used only for an NX701 Controller.

*2. This cannot be used for an NX102 or NX1P2 Controller.

*3. A CPU Unit with unit version 1.03 or later and Sysmac Studio version 1.04 or higher are required.

5-9-2 Procedure to Set Tasks

1 Double-click **Task Settings** under **Configurations and Setup** in the Multiview Explorer. The **Task Settings** Tab Page is displayed in the Edit Pane.

2 If the **Task Settings** view does not appear on the Task Settings Tab Page in the Edit Pane, click the **Task Settings** Button ().

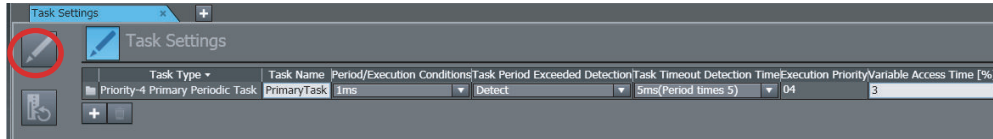

- 3** Select the task name, period/execution conditions, task period exceeded detection, task execution timeout detection time, and variable access time [%] from the lists for the registered task. For details on the settings, refer to the *NJ/NX-series CPU Unit Software User's Manual (Cat. No. W501)* or *NY-series Industrial Panel PC / Industrial Box PC Software User's Manual (Cat. No. W558)*.



Additional Information

Set the period of each periodic task to an integer multiple of the period of the primary periodic task.

If you set the task period of a periodic task and then change the period of the primary periodic task so that the task period of the periodic task is no longer an integer multiple, the period setting for the periodic task is automatically changed to the nearest integer multiple that can be set.

Example: If the period of the primary periodic task is set to 1 ms and the period of the priority-16 periodic task is set to 25 ms for an NJ-series CPU Unit and then the period of the primary periodic task is changed to 2 ms, the period of the priority-16 periodic task is automatically changed to 30 ms.

5-9-3 Task I/O Settings

- Task I/O Settings

The task I/O settings define what Units the task should perform I/O refreshing for.

Procedure to Set Task I/O Settings

- 1** Double-click **Task Settings** under **Configurations and Setup** in the Multiview Explorer.
- 2** Click the **I/O Control Task Settings** Button () on the Task Settings Tab Page in the Edit Pane.

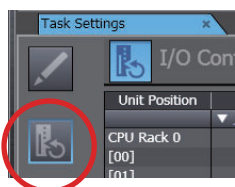

The **I/O Control Task Settings** is displayed.

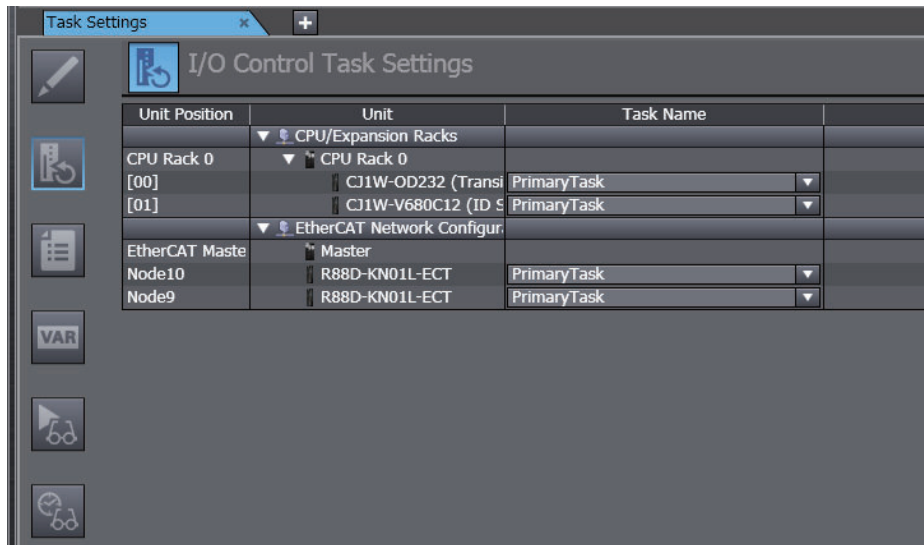

- 3 Select the task that should perform I/O refreshing for the registered Unit from the list.

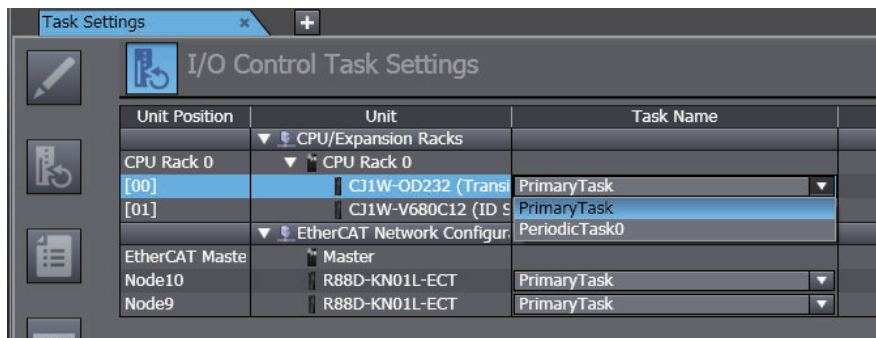

Task I/O settings can be defined only for the primary periodic task (priority 4), the priority-5 periodic task*¹, and the priority-16 periodic task*². You cannot define task I/O settings for priority-17 and priority-18 periodic tasks. Units specified in task I/O settings must already be registered under **Configurations and Setup – CPU/Expansion Racks** and **EtherCAT**.

*1. This can be used only for an NX701 Controller.

*2. This cannot be used for an NX102 or NX1P2 Controller.



Additional Information

You cannot change the task assignment for a slave/Unit that is assigned to an axis from the **I/O Control Task Settings** under the **Task Settings**. To change the task, change the task that is set for motion control in the **Axis Basic Settings** or clear the slave/Unit selection for the input device or output device in the **Axis Basic Settings** before you change the task.

5-9-4 Program Assignments

- Program Assignments

Program assignments define what programs a task will execute.

The programs that are assigned to a task are executed in the order that they are assigned.

With CPU Unit version 1.08 or later, you can set the startup operation for each program.

● Procedure to Assign Programs

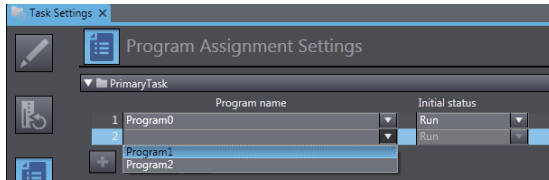

- 1 Double-click **Task Settings** under **Configurations and Setup** in the Multiview Explorer.
- 2 Click the **Program Assignment Settings** Button () in Task Settings Tab Page in the Edit Pane.
- 3 Select the programs to assign to the task from the list.



Any program you assign must already be registered under **Programming - POU**s.

● Adding, Reordering, and Deleting Assigned Programs

You can use the following buttons to add assigned programs, change the assigned order, or delete assigned programs.

Button	Description
	Adds a line for an assigned program.
	Moves the program on the line with the button up or down by one line to change the assigned order.
	Deletes the assigned program on the line with the button.



Additional Information

- You can also drag the program lines to change the order.
- When you change the assigned order or delete programs, you can select multiple continuous lines. Either hold down the Shift Key and press the Up or Down Key, or hold down the Shift Key and click the program lines with the mouse.
- You can expand and collapse the display of all of the programs that are registered in the tasks. Right-click the task title bar and select **Expand All** or **Collapse All** from the pop-up menu.

5-9-5 Settings for Exclusive Control of Variables in Tasks

You can use these settings to restrict tasks that refresh global variables and identify tasks that access global variables.

This ensures concurrency for global variable values from all tasks that reference them.

Configure the settings for exclusive control of variables in tasks from the task settings. You can register variables to the settings for exclusive control of variables in tasks from the global variable table or the POU displayed in the Ladder Editor.

● Procedure to Set Exclusive Control of Variables in Tasks

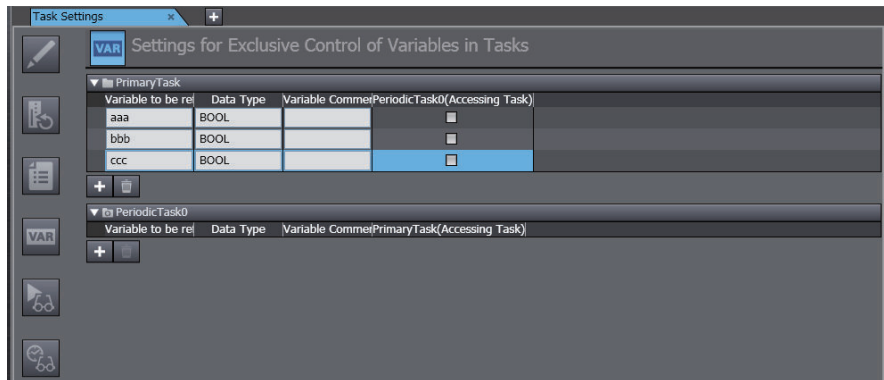

First, register the global variables to refresh in the primary periodic or periodic task (refreshing task). Then, specify tasks that only read the global variables (accessing tasks).

- 1 Double-click **Task Settings** under **Configurations and Setup** in the Multiview Explorer.
- 2 Click the Settings for Exclusive **Control of Variable in Tasks** Button () on the Task Settings Tab Page in the Edit Pane.
- 3 Register variables that require exclusive control between tasks. Select the global variables for which to specify a refreshing task. Then select the accessing task for the global variables.



● Adding or Deleting the Global Variables for Which to Specify the Refreshing Task

You can use the following buttons to add or delete the variables.

Button	Description
	Adds a line for the global variable that tasks refresh.
	Deletes the global variable of the selected line.

● Procedure to Quickly Register Variables to the Exclusive Control Settings from Global Variable Table

From the global variable table, register variables to the exclusive control settings.

You can change the settings of refreshing tasks and accessing tasks for multiple global variables at once.

- 1 Double-click **Global Variables** under **Programming** in the Multiview Explorer.

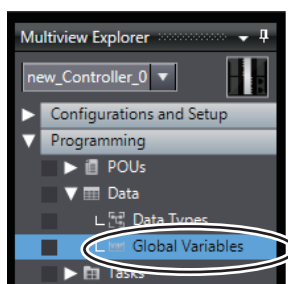

The global variable table is displayed.

- 2 Click the headers on the lines of the desired variables to select the entire lines and then right-click to select **Register to Settings for Exclusive Control of Variable in Tasks**.

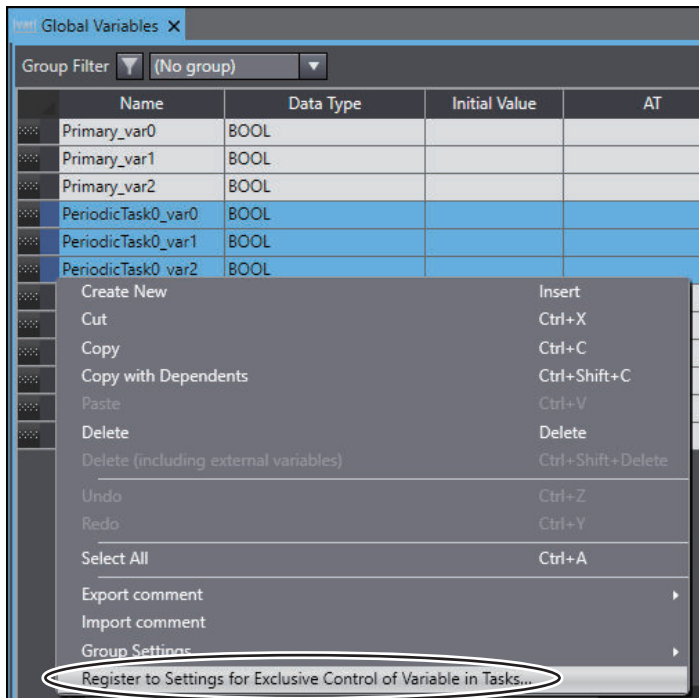

The **Register to Settings for Exclusive Control of Variables in Tasks** Dialog Box is displayed.

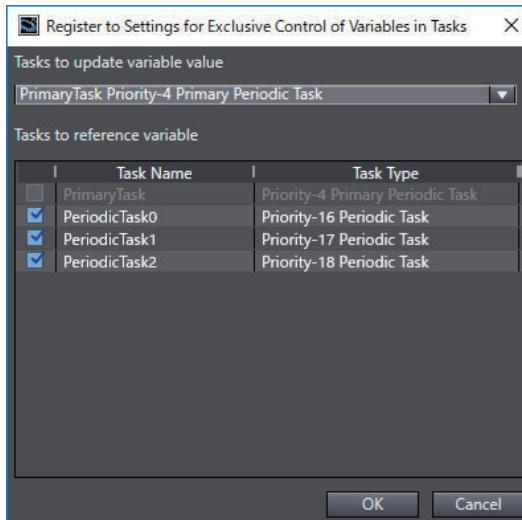

- 3 Click the combo box of tasks to update variable value to select a task that refreshes the variables.

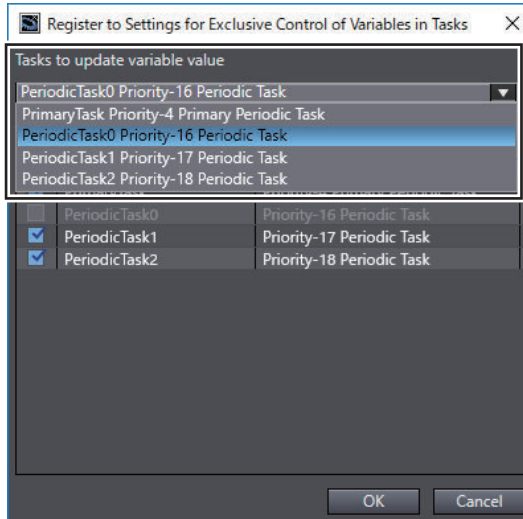

- 4** The check boxes of tasks to reference variable are checked by default. To prohibit a task from reading the variables, uncheck the check box.

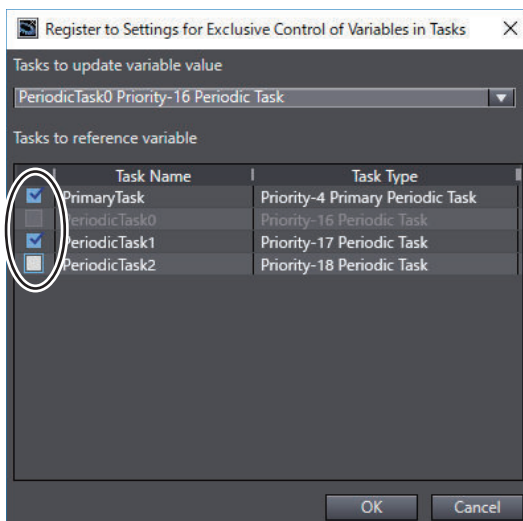

- 5** Click the **OK** Button.

When the registration is completed, the variables are registered to settings for exclusive control of variables in tasks and the registration results are displayed in the Output Tab Page.

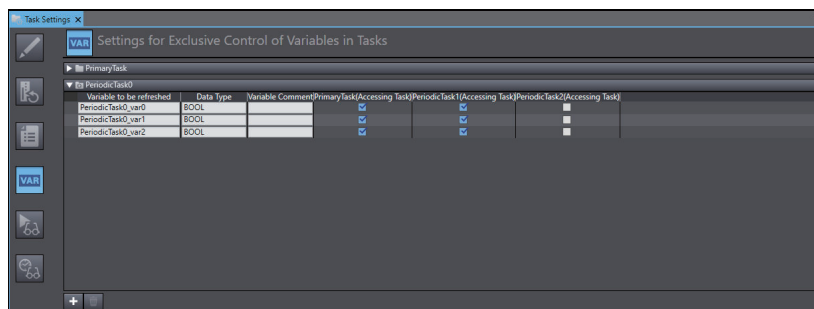

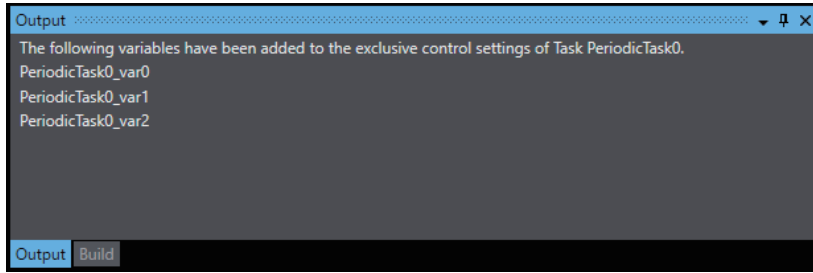

You can deregister a registered variable from the exclusive control settings through the **Settings for Exclusive Control of Variables** in Tasks Page.



Additional Information

- If you apply this function to a variable already registered to the exclusive control settings, a dialog box is displayed to confirm whether to overwrite the variable settings.
- You can detect network-published variables that are not registered in the settings for exclusive control of variables in tasks during the program check or when the user program is built. Refer to *8-26 Sysmac Studio Option Settings* on page 8-166 for detail.

● Procedure to Quickly Register Variables to the Exclusive Control Settings from the Ladder Editor

From the POU displayed in the Ladder Editor, register variables assigned to circuit parts to the exclusive control settings. The variables that you can register are as follows.

- Variables assigned to coils
- Variables assigned to output parameters of functions and function blocks

You can specify tasks that refresh or reference these variables.

- 1** In the Ladder Editor, right-click a coil or an output parameter of a function or function block, and then select **Register to Settings for Exclusive Control of Variable in Tasks**.

When the following conditions are met, **Register to Settings for Exclusive Control of Variable in Tasks** of the pop-up menu is enabled.

- The circuit part variable is registered to both the global variable table and local variable table, and is also not a system-defined variable,
- The POU is assigned to tasks, and
- The status is offline.

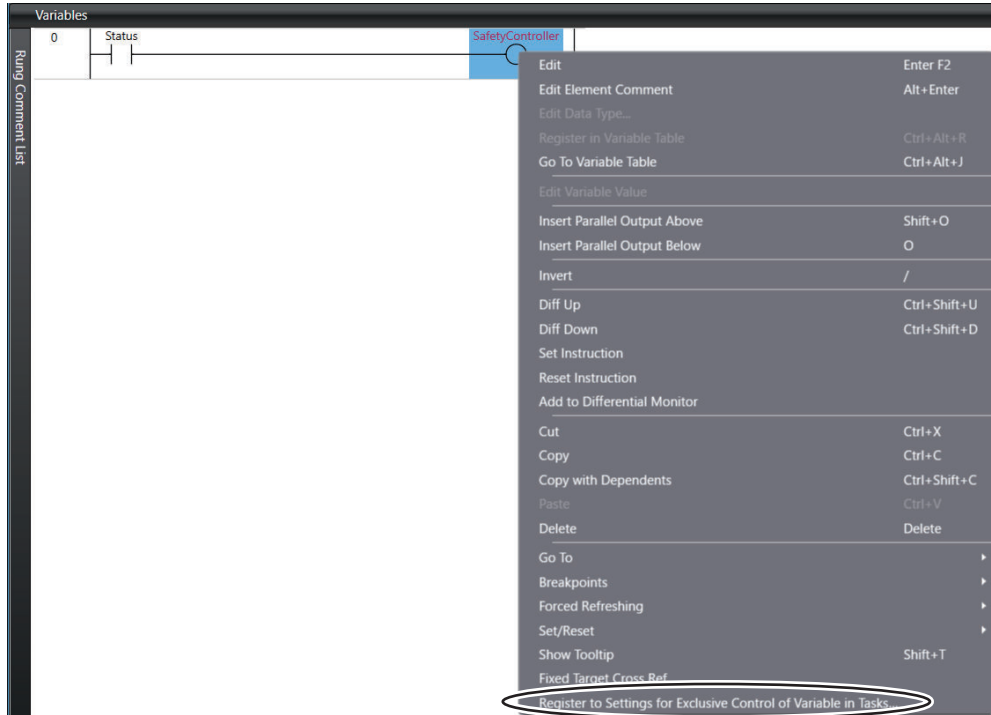

The **Register to Settings for Exclusive Control of Variables in Tasks** Dialog Box is displayed.

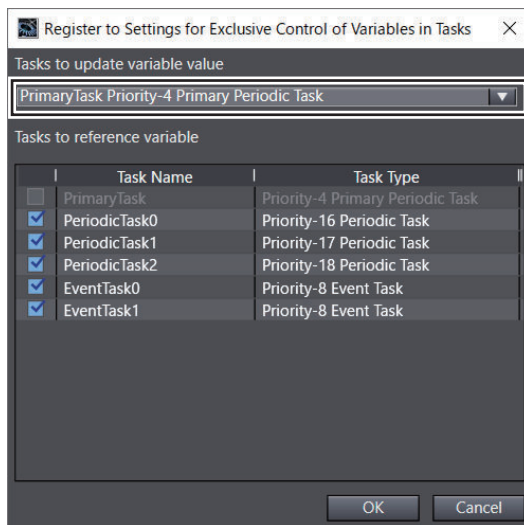

In **Tasks to update variable value**, a task to which the POU containing the specified circuit part is assigned is displayed.

- The check boxes of tasks to reference variable are all checked by default. To prohibit a task from reading the variable, uncheck the check box.

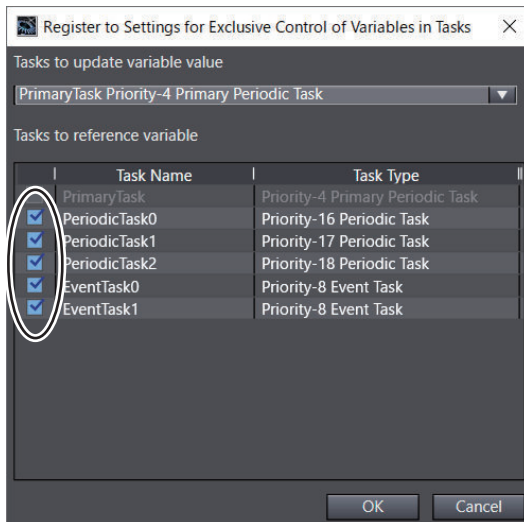

3 Click the **OK** Button.

When the registration is completed, the variable is registered to **Settings for Exclusive Control of Variables in Tasks** and the registration results are displayed in the Output Tab Page.

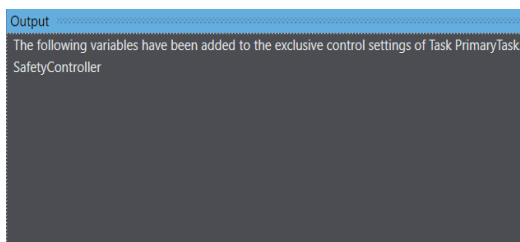
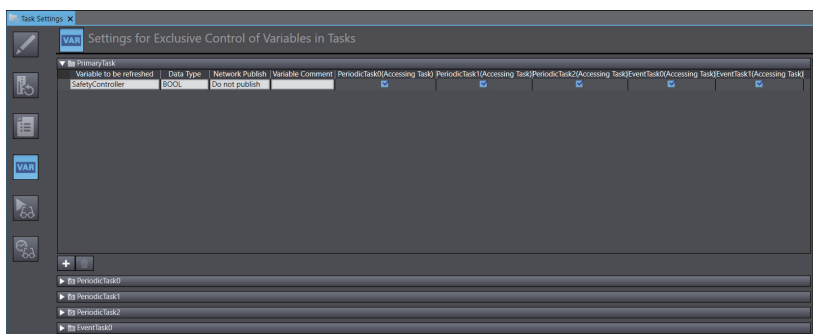

You can deregister a registered variable from the exclusive control settings through the **Settings for Exclusive Control of Variables in Tasks** Page.

6

Online Connections to a Controller

This section describes how to go online with a Controller.

6-1	Overview	6-2
6-2	Going Online with a Controller	6-3
6-2-1	Overview	6-3
6-2-2	Setting the Connection Method	6-5
6-2-3	Going Online	6-6
6-2-4	Going Online after Checking the Connection Method	6-7
6-2-5	Going Offline	6-7
6-2-6	Confirming the Serial ID	6-8
6-2-7	Checking for Forced Refreshing.....	6-9
6-2-8	Going Online without a Project.....	6-9

6-1 Overview

● Online Connections to a Controller

You must go online with the Controller or connect to the Simulator to communicate with them from the Sysmac Studio.

The Sysmac Studio supports the following online connections for different applications.

Online connection	Connection made to	Application
Online connection	Controller	To perform debugging, startup, or normal maintenance, the same project file as in the Controller is opened on the Sysmac Studio and then an online connection is made. An online connection is made based on the Communications Setup in the project file.
Simulator connection	Simulator	The Simulator is used to debug the user program offline. The Communications Setup in the project file is not used.



Additional Information



Refer to *7-3 Offline Debugging* on page 7-86 for information on connecting to the Simulator and debugging operations.

6-2 Going Online with a Controller

You can simultaneously go online with more than one Controller in a project from the Sysmac Studio. The operations that are described in this section apply to the currently selected Controller. If there is more than one Controller that is registered in the project, confirm the Controller to manipulate before connecting to it.

6-2-1 Overview

To go online with a Controller, there are four types of hardware connections that can be used. These are described in the following table.

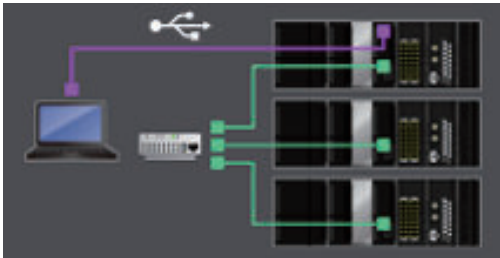
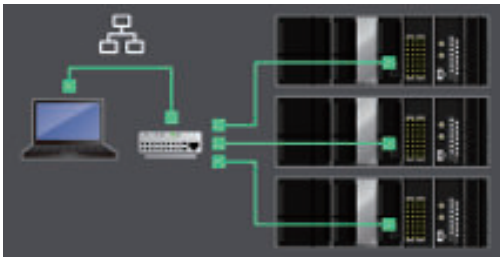
Connection method	Connection diagram	Description
Direct connection via USB* ¹		The USB port on the computer is connected directly to the peripheral USB port on the Controller.
Direct connection via Ethernet		The Ethernet port on the computer is connected directly to the built-in EtherNet/IP port on the Controller.
Remote connection via USB		The USB port on the computer is connected directly to the peripheral USB port on a Controller and then a connection is made through the Ethernet network to the built-in EtherNet/IP port on another Controller.* ²
Ethernet connection via a hub		The Ethernet port on the computer is connected through the Ethernet network to the built-in EtherNet/IP port on a Controller.* ²

*1. This is not displayed for NY-series Controllers and NX502, NX102, or NX1P2 Controllers.

*2. You cannot go online with a Controller through the port on a CJ-series EtherNet/IP Unit.



Precautions for Correct Use

For the following Controllers, use a computer with Windows 10 version 1803 or later. With Windows 10 version 1709 or earlier, you cannot go online with the Controller.

- NX701 Controllers with unit version 1.29 or later
- NX502 Controllers with unit version 1.60 or later
- NX102, NX1P2, or NJ-series Controllers with unit version 1.49 or later

Refer to the *NJ/NX-series CPU Unit Software User's Manual (Cat. No. W501)* for details on Windows versions supported by the CPU Units. Refer to the *NJ/NX-series Troubleshooting Manual (Cat. No. W503)* for information on what to do if you cannot go online.

6-2-2 Setting the Connection Method

You must set the connection method, IP address to connect to, and other parameters for communications between the computer and Controller.

- 1 Select **Communications Setup** from the **Controller Menu**.
The **Communications Setup** Dialog Box is displayed.

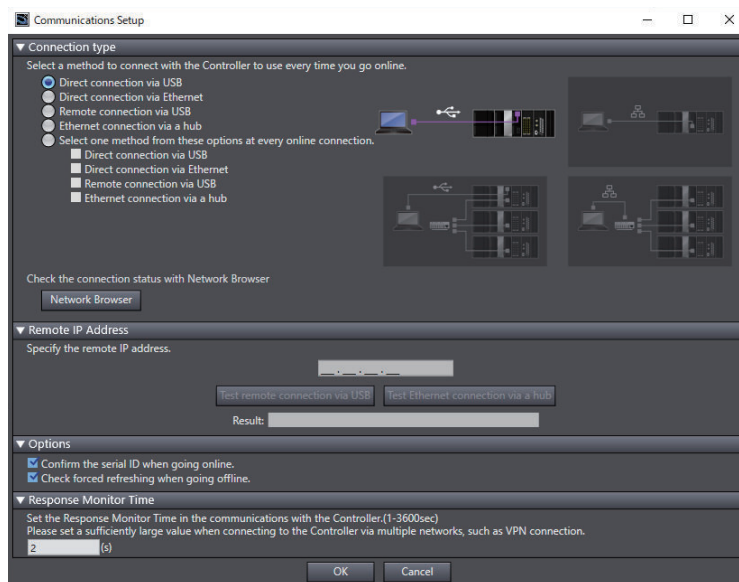

- 2 Select the connection method in the **Connection Type** Field.
For a remote USB connection or Ethernet hub connection, enter the IP address of the Controller to which you need to connect in the **Remote IP Address** Field.
Select any required options and enter the response timeout time if required.
Refer to **Communications Setup Dialog Box Settings** on page 6-5 for information on the settings.
- 3 Click the **OK** Button.
This completes the settings.

● Communications Setup Dialog Box Settings

Item	Description	
Connection Type	Select the connection port to use to go online. The selected method is normally used to go online.	
	Network Browser	This button displays the Network Browser dialog box to check the status of the connection to a Controller.
Remote IP Address	If you specify a USB remote or Ethernet hub connection, set the IP address of the Controller that you normally will connect to.	
	Test remote connection via USB Test Ethernet connection via a hub	These buttons perform a communications test with the Controller at the specified remote IP address. The result is displayed in the Result field as follows: <ul style="list-style-type: none"> • Normal: <i>Communications test successful.</i> • Error: <i>The Controller was not found, There is more than one Controller with the specified IP address, or a communications error occurred.</i>

Item	Description	
Options	Confirm the serial ID when going online.	If you select this option, the names and the Serial ID are compared between the project and the Controller when you go online to make sure that a connection is made to the intended Controller.
	Check forced refreshing when going offline.	When this option is selected, a check is made when breaking the connection for inputs or outputs that have forced refreshing.
Response Monitor Time	<p>You can set the response monitoring time for communications with the Controller.</p> <p>An error is displayed if a response is not received before this time expires.</p> <ul style="list-style-type: none"> The time can be set to between 1 and 3,600 s. <p>You can change the default value of the response monitoring time in the Option Dialog Box.</p>	



Additional Information

To connect to a Controller via two or more networks such as when using a VPN connection, a response timeout may occur because it takes long time to establish communication. In such a case, set a sufficiently large value for the response monitoring time.

6-2-3 Going Online

Use the following procedure to place the Sysmac Studio online with the Controller.

- 1 Select **Online** from the **Controller** Menu. Or, click the Go Online Button () in the toolbar. The following message is displayed the first time you go online. After you write the project name, this message is not displayed.

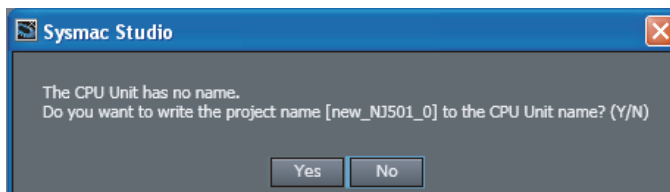

- 2 Click the **Yes** Button. The Sysmac Studio goes online and the color of the top of the Edit Pane changes to yellow.

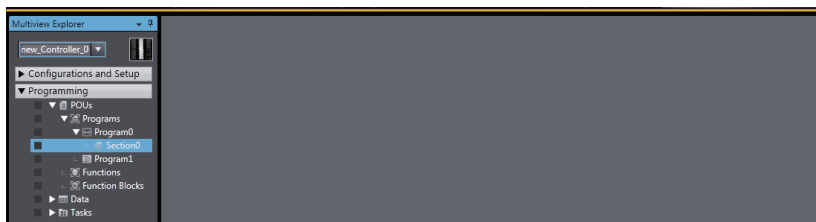

Precautions for Correct Use

Do not reconnect the USB for at least 10 seconds after you disconnect it. After you connect the USB cable, do not disconnect it until Windows detects the connection. It may become impossible for Windows to detect when the cable is connected or disconnected, which would effectively disable the USB port. If that occurs, restart the computer. Otherwise, you will not be able to use the USB device until Windows recovers from the suspended status.



Additional Information

If the Windows firewall is enabled, a dialog box is sometimes displayed to confirm the connection the first time you go online with a Controller after you install the Sysmac Studio. In this case, click the **Allow access** Button with the **Public networks** Check Box selected. If you do not allow access, you cannot transfer EtherNet/IP connection settings or monitor EtherNet/IP connections. Refer to the *NJ/NX-series CPU Unit Built-in EtherNet/IP Port User's Manual (Cat. No. W506)* or *NY-series Industrial Panel PC / Industrial Box PC Built-in EtherNet/IP Port User's Manual (Cat. No. W563)* for details.

6-2-4 Going Online after Checking the Connection Method

Use the following procedure to go online if you selected the option to select the connection method whenever you connect the computer with the Controller in the **Communications Setup** Dialog Box.

- 1 Select **Online** from the **Controller** Menu. Or, click the Go Online Button () in the toolbar. The **Communication Settings** Dialog Box is displayed.

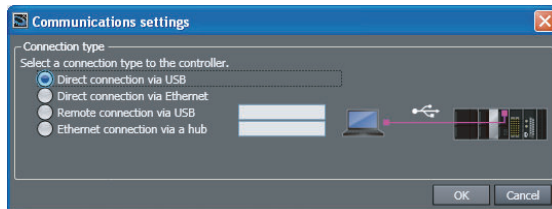

The IP address that is set in the Communications Setup Dialog Box is displayed to the right of the remote connection methods.

- 2 Select the connection method and then click the **OK** Button. The Sysmac Studio goes online.



Precautions for Correct Use

Do not reconnect the USB for at least 10 seconds after you disconnect it. After you connect the USB cable, do not disconnect it until Windows detects the connection. It may become impossible for Windows to detect when the cable is connected or disconnected, which would effectively disable the USB port. If that occurs, restart the computer. Otherwise, you will not be able to use the USB device until Windows recovers from the suspended status.

6-2-5 Going Offline

Use the following procedure to go offline.

- Select **Offline** from the **Controller** Menu. Or, click the Go Offline Button () in the toolbar. The Sysmac Studio goes offline.

6-2-6 Confirming the Serial ID

The Serial ID

When the Sysmac Studio first connects online, you can obtain the serial ID from the CPU Unit's production information and store it in the project.

After that, when the Sysmac Studio connects online, both the CPU Unit name and the serial ID are compared. This enables stricter verification of the CPU Unit.

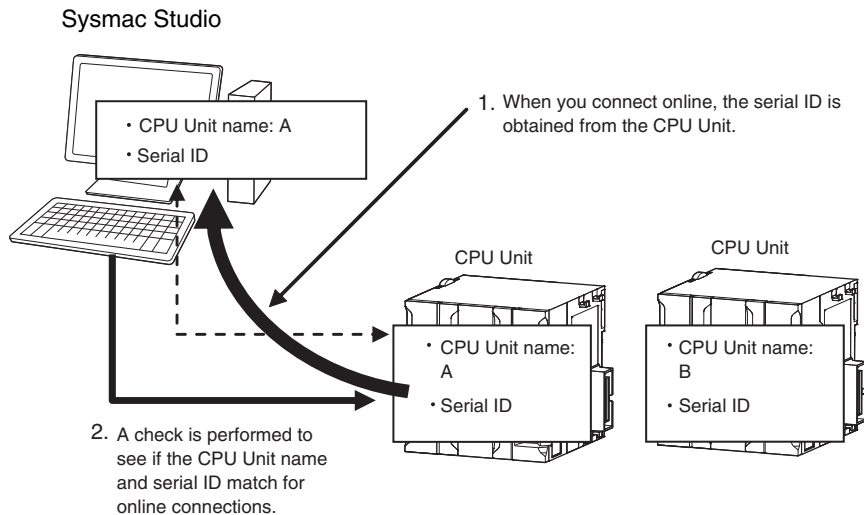

Procedure to Confirm the Serial ID

The serial ID is verified when going online if the option to do so was selected in the Communications Setup Dialog Box. If the serial ID of the project on the Sysmac Studio is different from that of the Controller, the following confirmation dialog box is displayed when you attempt to go online.

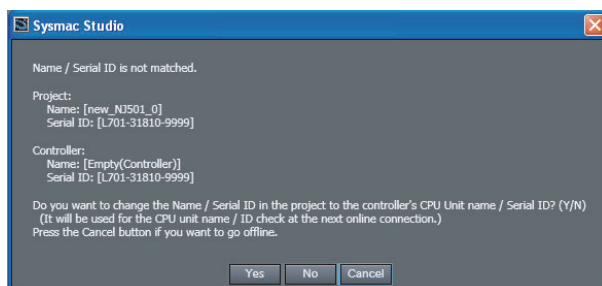

1 Click the **Yes** Button.

The serial ID of the project on the Sysmac Studio is rewritten to the same value as that of the Controller.

6-2-7 Checking for Forced Refreshing

Forced refreshing is checked when going offline if the option to do so was selected in the **Communications Setup** Dialog Box. If there are any variables that have been forced refreshed, the following confirmation dialog box is displayed after you go online.

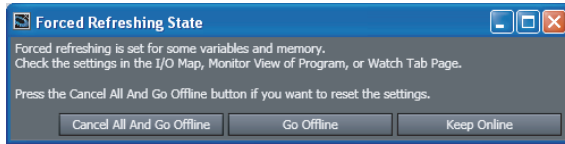

- 1 Click the **Cancel All And Go Offline** Button.
All of the forced refreshing is released.
- 2 Click the **Go Offline** Button.
The Sysmac Studio goes offline.



Precautions for Correct Use

- If a direct or remote USB connection is used, an Ethernet IP address of *192.168.255.xxx* is used internally. When using a USB connection, do not use an IP address of *192.168.255.xxx* for the Ethernet interface card in the computer, or do not remotely connect to a Controller with an IP address of *192.168.255.xxx*.
- Socket ports *9600* and *2224* are used for Ethernet UDP/IP communications. When using Ethernet UDP/IP communications, do not use these ports for any other application.
- When using *Direct connection via Ethernet* and there is more than one Ethernet interface card mounted in the computer, you must select the Ethernet interface card to use. Refer to *A-2 Specifying One of Multiple Ethernet Interface Cards* on page A-11 for the selection procedure.
- If the NJ/NX-series Controller has the following settings, you might not be able to go online with it by using **Direct connection via Ethernet**, **Remote connection via USB**, or **Ethernet connection via a hub**.
 - a) **CIP Message Server** in Built-in EtherNet/IP Port Settings is set to **Do not use**.
 - b) **Packet Filter** in Built-in EtherNet/IP Port Settings is set to **Use**.
Refer to the *NJ/NX-series CPU Unit Built-in EtherNet/IP Port User's Manual (Cat. No. W506)* for details on the settings.
- If you select *Direct connection via Ethernet* to connect to the NX701, NX502, or NX102 Controller, or the NX-CSG320 Communication Control Unit, connect the cable to Port 1 on the Controller. You cannot go online if you connect the cable to Port 2.



Additional Information

- Refer to *11-4 Error Messages for Sysmac Studio Operation* on page 11-11 for corrections for errors that occur when you go online.
- If operation authority is set in the Controller, a Verification Dialog Box is displayed when you go online. Refer to *8-3-2 Operation Authority Verification* on page 8-11 for details.
- If user authentication is set in the Controller, a user authentication dialog box is displayed when you go online. Refer to *8-3-3 User Authentication* on page 8-19 for details on the user authentication.

6-2-8 Going Online without a Project

You can go online with the Controller without creating or opening a project.

When you are online, you can upload the project data or perform troubleshooting.

- 1 Start the Sysmac Studio and click **Connect to Device** on the Start page. Settings are displayed.

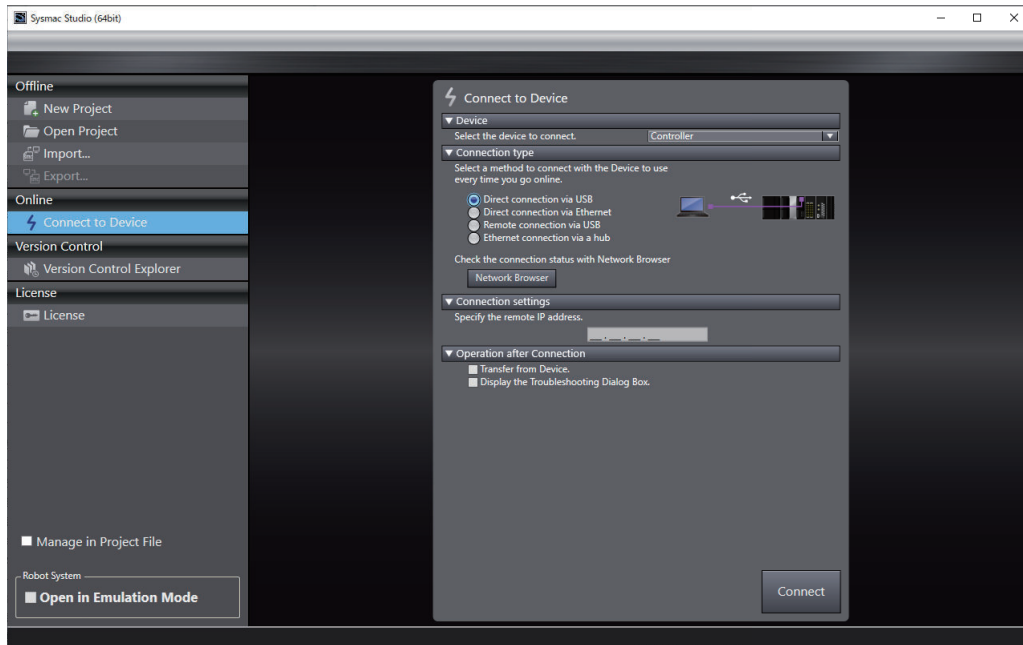

Item	Description		
Device	Select the type of device to connect to.		
Connection type	Select the method to use to connect to the Controller.		
	Network Browser	This button displays the Network Browser dialog box to check the status of the connection to a Controller.	
Connection settings	If you selected a remote connection via USB or an Ethernet connection via a hub, set the destination IP address.		
Operation after Connection	Select the operation to perform after connecting.		
	<ul style="list-style-type: none"> • Transfer from Device 	<ul style="list-style-type: none"> • CPU Unit The data is uploaded from the Controller if there is a project in the Controller. If you select this check box, check boxes to select the items to upload are displayed. <p>The data in the CPU Unit, such as the programs, configurations, and settings, are uploaded.</p> This data includes the EtherCAT connection settings (i.e., the tag data link settings), but it does not include the data from the CJ-series Units or EtherCAT slaves. This data is always uploaded.	
		<ul style="list-style-type: none"> • CJ-series Units (NJ-series only)/ EtherCAT slaves/NX Units 	If you select this check box, the data from the CJ-series Units, EtherCAT slaves, and NX Units is uploaded.
		<ul style="list-style-type: none"> • Display the Troubleshooting Dialog Box: 	The Troubleshooting Dialog Box is displayed.

2 Click the **Connect** Button.

A new project is created automatically and the Sysmac Studio goes online with the Controller according to the settings made in step 1, above.

A project named *Auto Connect Project* is created. To save the project, either select **Save As** from the **File** Menu or click the **Yes** Button on the Save Confirmation Dialog Box that appears when you close the project.



Additional Information

For the *author* of the created project, the author name that is set in the option settings is set automatically. Refer to 8-26 *Sysmac Studio Option Settings* on page 8-166 for details on the option settings.



Debugging

This section describes how to debug the programs online on the Controller or debug it offline with the Simulator.

7-1	Debugging Operations on the Simulator and Controller.....	7-2
7-2	Operations Used for Both Online and Offline Debugging.....	7-4
7-2-1	Monitoring.....	7-4
7-2-2	Differential Monitor	7-21
7-2-3	Changing Present Values and Set/Reset Using Forced Refreshing	7-24
7-2-4	Cross References.....	7-36
7-2-5	Online Editing.....	7-41
7-2-6	Changing the Operating Mode	7-45
7-2-7	Monitoring Controller Status.....	7-46
7-2-8	Task Execution Status Monitor	7-50
7-2-9	Task Execution Time Monitor	7-50
7-2-10	Axis Status Monitor (MC Monitor Table).....	7-51
7-2-11	Data Tracing	7-53
7-2-12	Output Factor Search	7-80
7-3	Offline Debugging	7-86
7-3-1	Debugging with Program Simulation	7-86
7-3-2	Offline Debugging of Sequence and Motion Control Programs	7-106
7-3-3	Offline Debugging for Sequence Control and Vision Sensor.....	7-109
7-3-4	Offline Debugging for Sequence Control and Displacement Sensor	7-113
7-3-5	Offline Debugging with Sequence Control and NA-series PT Simulator (Simultaneous Simulation of Controller with NA-series PT).....	7-115
7-3-6	Integrated NS-series PT Simulation for Offline Debugging of Sequence Control and NS-series PTs	7-118
7-3-7	Offline Debugging for Sequence Control and Safety CPU Units.....	7-120
7-3-8	3D Simulation	7-120
7-3-9	Executing OPC UA Server on the Simulator	7-121
7-4	Preparations for Online Debugging.....	7-122
7-4-1	Assigning Variables and Real I/O	7-122
7-4-2	Assigning Axis Variables and I/O Devices.....	7-124
7-5	Performing Online Debugging	7-126
7-5-1	Transferring/Comparing Data to/from the Controller	7-127
7-5-2	Testing Axis Operation (MC Test Run)	7-149
7-5-3	Checking I/O Wiring	7-153
7-5-4	Checking I/O Assignments	7-154
7-5-5	Resetting the Controller.....	7-155
7-5-6	Restarting Units.....	7-156

7-1 Debugging Operations on the Simulator and Controller

The operations that can be used to debug the programs on the Sysmac Studio are listed below. Debugging can be performed online on the Controller or offline with the Simulator.

Operations for Debugging	Controller	Simulator	Reference
Monitoring	Supported.	Supported.	7-2-1 <i>Monitoring</i> on page 7-4
Monitoring in a Watch Tab Page	Supported.	Supported.	7-2-1 <i>Monitoring</i> on page 7-4
Monitoring in the I/O Map	Supported.	Supported.	7-2-1 <i>Monitoring</i> on page 7-4
Differential monitoring	Supported.	Supported.	7-2-2 <i>Differential Monitor</i> on page 7-21
Controlling BOOL variables	Supported.	Supported.	7-2-3 <i>Changing Present Values and Set/Reset Using Forced Refreshing</i> on page 7-24
Forced Refreshing (TRUE/FALSE/Cancel)	Supported.	Supported.	7-2-3 <i>Changing Present Values and Set/Reset Using Forced Refreshing</i> on page 7-24
Changing present values of data	Supported.	Supported.	7-2-3 <i>Changing Present Values and Set/Reset Using Forced Refreshing</i> on page 7-24
Clear All Memory operation	Supported.	Not supported.	8-6 <i>Clearing Memory</i> on page 8-58
Cross-references	Supported.	Supported.	7-2-4 <i>Cross References</i> on page 7-36
Online editing	Supported.	Supported.	7-2-5 <i>Online Editing</i> on page 7-41
Monitoring Controller information	Supported.	Not supported.	7-2-7 <i>Monitoring Controller Status</i> on page 7-46
Monitoring task execution status	Supported.	Supported.	7-2-8 <i>Task Execution Status Monitor</i> on page 7-50
Monitoring axis status	Supported.	Supported.	7-2-10 <i>Axis Status Monitor (MC Monitor Table)</i> on page 7-51
Changing the operating mode	Supported.	Supported.	7-2-6 <i>Changing the Operating Mode</i> on page 7-45
Resetting the Controller	Supported.	Not supported.	7-5-5 <i>Resetting the Controller</i> on page 7-155
Data tracing	Supported.	Supported.	7-2-11 <i>Data Tracing</i> on page 7-53
Setting triggers	Supported.	Supported.	7-2-11 <i>Data Tracing</i> on page 7-53
Setting variables to sample	Supported.	Supported.	7-2-11 <i>Data Tracing</i> on page 7-53

Operations for Debugging	Controller	Simulator	Reference
Starting and stopping tracing	Supported.	Supported.	7-2-11 <i>Data Tracing</i> on page 7-53
Displaying trace results	Supported.	Supported.	7-2-11 <i>Data Tracing</i> on page 7-53
Saving trace results	Supported.	Supported.	7-2-11 <i>Data Tracing</i> on page 7-53
Setting the 3D equipment model	Supported.	Supported.	7-2-11 <i>Data Tracing</i> on page 7-53
Displaying timing charts	Supported.	Supported.	7-2-11 <i>Data Tracing</i> on page 7-53
Displaying 3D axis paths	Supported.	Supported.	7-2-11 <i>Data Tracing</i> on page 7-53
Monitoring task execution times	Supported.	Supported.	7-2-9 <i>Task Execution Time Monitor</i> on page 7-50
Estimating execution processing times	Not supported.	Supported.	7-3-1 <i>Debugging with Program Simulation</i> on page 7-86
Debugging with program simulations	Not supported.	Supported.	7-3-1 <i>Debugging with Program Simulation</i> on page 7-86
Setting what to simulate	Not supported.	Supported.	7-3-1 <i>Debugging with Program Simulation</i> on page 7-86
Changing the simulation speed	Not supported.	Supported.	7-3-1 <i>Debugging with Program Simulation</i> on page 7-86
Setting breakpoints	Not supported.	Supported.	7-3-1 <i>Debugging with Program Simulation</i> on page 7-86
Step execution	Not supported.	Supported.	7-3-1 <i>Debugging with Program Simulation</i> on page 7-86
Troubleshooting	Supported.	Supported.	8-16 <i>Troubleshooting</i> on page 8-120
Monitoring error information	Supported.	Supported.	8-16 <i>Troubleshooting</i> on page 8-120
Displaying error logs	Supported.	Supported.	8-16 <i>Troubleshooting</i> on page 8-120
Event Setting Table	Supported.	Supported.	8-16 <i>Troubleshooting</i> on page 8-120
User Memory Usage Monitor	Supported.	Supported.	8-4 <i>User Memory Usage Monitor</i> on page 8-49
Clock Information Settings	Supported.	Not supported.	8-2 <i>Clock Information Settings</i> on page 8-8
Releasing access rights	Supported.	Not supported.	8-7 <i>Releasing Access Rights</i> on page 8-64

Note For the functional differences between the Controller and Simulator, refer to *A-4 Differences between the Simulator and the Physical Controller* on page A-15.

7-2 Operations Used for Both Online and Offline Debugging

7-2-1 Monitoring

- **Overview**

You can monitor the TRUE/FALSE status of program inputs and outputs and the present values of variables in the Controller. You can monitor operation on the Ladder Editor, ST Editor, Watch Tab Page, or I/O Map.

Monitoring on the Ladder Editor

- **Monitoring on the Ladder Editor**

You can check the execution status of a ladder diagram on the Ladder Editor.

- **Procedure to Monitor on the Ladder Editor**

- 1 Double-click the ladder program or ladder function block under **Programming** in the Multiview Explorer.

The rungs are displayed on the Ladder Editor in monitor status.

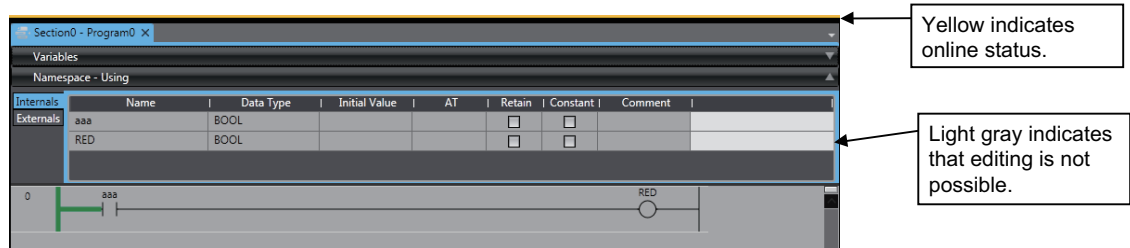

The TRUE/FALSE status of the connecting lines is displayed while the task is executed in RUN mode.

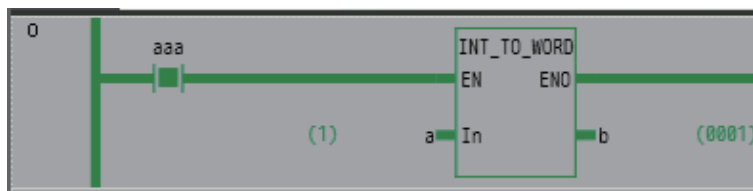

Circuit parts are displayed as follows during monitoring:
You can change the display color in the option settings.

Input and Output Bits

Circuit part	TRUE	FALSE
Program input		
Program output		

Functions and Function Blocks

Circuit part	Being executed	Not being executed	When the execution status cannot be monitored *3
Functions and function blocks *1	<p>*2</p>		

- *1. While the task is in execution in RUN mode, a function block is always displayed in *execution in progress status* regardless of the TRUE/FALSE status of the connecting line before it.
- *2. The present values are displayed in parentheses to the left of input variables and to the right of output variables.
The present values are displayed in parentheses to the left and right of in-out variables.
- *3. The execution status cannot be displayed under the following conditions. In these cases, the circuit part and the connecting lines after it are displayed in yellow.
 - Inputs, functions, and function block instances from immediately after going online until the monitored values are displayed
 - Function block instances for which arrays with subscript variables are specified
 - Inputs, functions, and function block instances that do not exist in the Controller when synchronization is not consistent
 - Functions that meet the following conditions:
 - a) Some instructions that do not have an ENO output
Examples of instructions for which execution status cannot be monitored:
Timer (Hundred-ms Timer), Get**Clk (Get Clock Pulse Group), and comparison instructions, such as LT, EQ, and NE, when the comparison data is duration data, date data, time of day data, or STRING data.
Examples of instructions for which execution status can be monitored:
TestABit (Test A Bit), TestABitN (Test A Bit Not), and comparison instructions such as LT, EQ, and NE when the comparison data is BOOL data, bit string data, integer data, or REAL data
 - b) All instructions in regions that are defined with the MC and MCR instructions
 - c) All user-defined functions
 - A POU using the P_PRGER (Instruction error flag) variable
 - A program in which the value of the P_PRGER (Instruction error flag) variable is TRUE
P_PRGER is a flag that remains TRUE when an instruction error occurs in a program, function block/ function called from the program. Refer to *NJ/NX-series CPU Unit Software User's Manual (Cat. No. W501)* for details on P_PRGER.



Additional Information

- If you use a variable for a subscript to specify an array element or member in an array variable, structure array variable, or union array variable, the present value is displayed as follows (example for a two-dimensional array): *Value_of_variable_element_or_member, [subscript_value, subscript_value]*.

Variable name entry format example for global variables	Present value display
ArrayVar[index1,index2,index3]	Value_of_ArrayVar[index1,index2,index3],[value_of_index1, value_of_index2, value_of_index3]
StructArrayVar[index1,index2].member	Value_of_StructArrayVar[index1,index2].member,[value_of_index1, value_of_index2]
StructArrayVar[index1,index2].member [0,index3]	Value_of_StructArrayVar[index1,index2].member [0,value_of_index3],[value_of_index1, value_of_index2], [0, value_of_index3]

You can set an option so that the present values of array subscripts are not displayed. Refer to *8-26 Sysmac Studio Option Settings* on page 8-166 for details.

- If the value of the P_PRGER variable changes to TRUE and monitoring is disabled, change the value of the P_PRGER variable to FALSE from a Watch Tab Page to enable monitoring again.

Monitoring on the ST Editor

● Monitoring on the ST Editor

You can confirm the present values of variables in structured text in the ST Editor. Use the following procedure to monitor present values.

- Double-click the ST program or ST function block under **Programming** in the Multiview Explorer. The ST Editor is displayed.

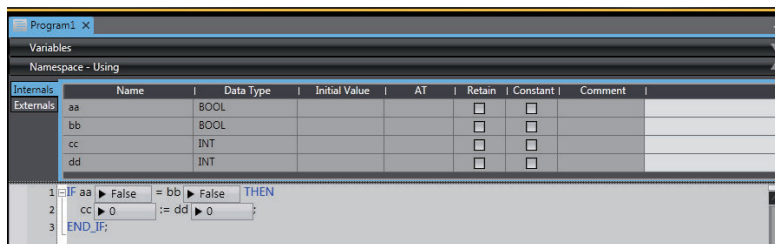



Additional Information

If you use a variable for a subscript to specify an array element or member in an array variable, structure array variable, or union array variable, the present value is displayed as follows (example for a two-dimensional array): *Value_of_variable_element_or_member, [subscript_value, subscript_value]*.

Variable name entry format example for global variables	Present value display
ArrayVar[index1,index2,index3]	Value_of_ArrayVar[index1,index2,index3],[value_of_index1, value_of_index2, value_of_index3]
StructArrayVar[index1,index2].member	Value_of_StructArrayVar[index1,index2].member,[value_of_index1, value_of_index2]
StructArrayVar[index1,index2].member [0,index3]	Value_of_StructArrayVar[index1,index2].member [0,value_of_index3],[value_of_index1, value_of_index2],[0, value_of_index3]

You can set an option so that the present values of array subscripts are not displayed. Refer to *8-26 Sysmac Studio Option Settings* on page 8-166 for details.

Monitoring Function Block Instances

You can monitor the execution status of ladder diagrams or ST programs for individual function block instances.

- 1 Go online and then double-click the function block definition on the Multiview Explorer. Or, double-click the function block definition in the Edit Pane.
The Choose Instance Dialog Box is displayed.

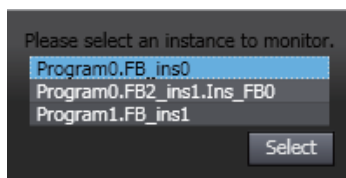

- 2 Select the function block instance to monitor and click the **Select** Button.
The contents of the selected instance are displayed. The name of the selected instance is displayed on the tab.

● Monitoring the Present Values of In-Out Variables in Function Block Instances

The operation of monitoring the present values of in-out variables in function block instances differs depending on the combination of the Sysmac Studio version and the project unit version of the model.

The combinations that allow you to monitor the present values of in-out variables in the function block instances are as follows. Except for the following combinations, you cannot monitor the present values. A hyphen is displayed for the present value.

Sysmac Studio version 1.41 or higher

Model	Project unit version
NX701-1□00, NX701-1□20	Version 1.23 or later
NX102-1□20, NX102-9□20	Version 1.35 or later
NJ501-1□20, NJ501-4320	Version 1.23 or later
NJ101-□020	Version 1.23 or later

Sysmac Studio version 1.43 or higher

Model	Project unit version
NX1P2	Version 1.42 or later
NX102-1□00, NX102-9□00	Version 1.42 or later
NJ501-1□00	Version 1.42 or later
NJ301-1□00	Version 1.42 or later
NJ101-□000	Version 1.42 or later

Sysmac Studio version 1.44 or higher

Model	Project unit version
NJ501-R□00, NJ501-R□20	Version 1.43 or later

Sysmac Studio version 1.45 or higher

Model	Project unit version
NY512-1□00, NY512-Z□00, NY532-1□00, NY532-Z□00	Version 1.24 or later

Sysmac Studio version 1.46 or higher

Model	Project unit version
NX701-Z□□□, NJ501-4□□□, NJ501-1340, NJ501-5300	Version 1.24 or later

Sysmac Studio version 1.54 or higher

Model	Project unit version
NX502-1□00	Version 1.60 or later

Monitoring in a Watch Tab Page

● Monitoring in a Watch Tab Page

You can check the present value of one or more variables in the Watch Tab Page.

There are the following types of Watch Tab Pages.

- Watch (Project)

This Watch Tab Page contains information for devices that are registered in the project. You can check the current values for more than one device at the same time.

- Watch (Table)

This Watch Tab Page contains information for Controllers that are registered in the project. You can use it to check the present values of array variable elements and structure members in tabular form.

● Displaying a Watch Tab Page

- 1 Select **Watch Tab Page** from the **View** Menu. To display the Watch (Table), select **Watch Tab Page (Table)**.

The Watch (Project) 1 or Watch (Table) 1 is displayed.

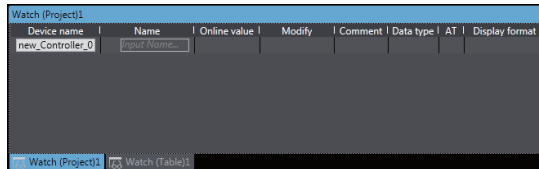

To close a Watch Tab Page, click the Close Button for the tab page. To display a Watch Tab Page, select **Watch Tab Page** from the **View** Menu again.



Additional Information

You can change the tab title for Watch Tab Pages. Select **Edit Title** from the pop-up menu for the tab.

● Contents of the Watch Tab Page

- Watch Tab Page (Project)

Item	Meaning	Editing	Remarks
Device name	The device name is displayed.	Supported.	
Name	The variable name is displayed.	Supported.	
Online value	The present values of the device are displayed.	---	
Modify	The new value is displayed.	Supported.	
Comment* ¹	A comment for the variable is displayed.	---	
Data type* ¹	The data type is displayed.	---	Refer to <i>Format to Register Variables on Registering Variables in the Watch Tab Page</i> on page 7-11 for the data types that you can register.
AT* ¹	The address of an AT specification in memory for CJ-series Units or an I/O port is displayed.	---	
Display format* ¹	The display format (decimal, hexadecimal, etc.) of the present value and modify value is displayed.	Supported.	Refer to <i>Changing the Display Format of a Present Value in the Watch Tab Page</i> on page 7-15 for the data formats that you can select.

*1. You can right-click the title row cell for the column to show and hide columns.

- Watch Tab Page (Table)

This tab page is described using the following figure as an example.

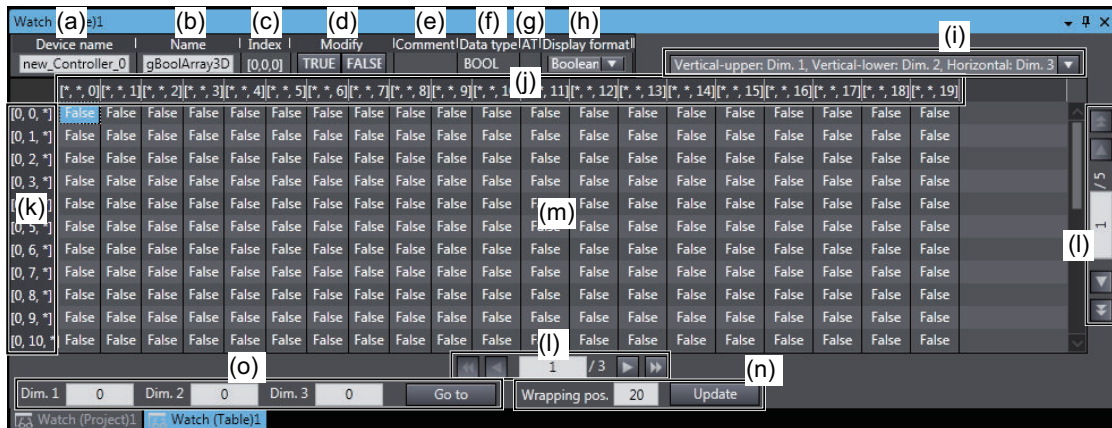

No.	Item	Meaning	Editing	Remarks
(a)	Device name	The Controller name is displayed.	Supported.	
(b)	Name	The variable name is displayed.	Supported.	
(c)	Index	The subscript of the structure member or array element that is selected in the present value table is displayed. If a member is selected, the member name is also displayed.	---	
(d)	Modify	The new value is displayed.	Supported.	
(e)	Comment	The comment for the variable is displayed.	---	
(f)	Data type	The data type is displayed.	---	
(g)	AT	The address of an AT specification in memory for CJ-series Units or an I/O port is displayed.	---	
(h)	Display format	The display format used for both the present values in the present value table and the Modify value is displayed.	Supported.	<ul style="list-style-type: none"> Refer to <i>Changing the Display Format of a Present Value in the Watch Tab Page</i> on page 7-15 for the display formats that you can select. For structure variables or structure array variables, the present values displayed in the present value table will not change even if you change the display format.
(i)	Array display direction selection list	Used to select the directions in which to display the array dimensions from a list.	Supported.	A list is displayed only for an array variable with a basic data type or a structure array variable with two or more dimensions.

No.	Item	Meaning	Editing	Remarks
(j)	Horizontal subscript display area	The subscripts of the specified dimension are displayed horizontally in order from 0. The array elements of the structure members are all expanded on the display.	---	
(k)	Vertical subscript display area	The subscripts for the dimension that is not displayed in the horizontal subscript display area are displayed vertically in order from 0. For a three-dimensional array, the subscripts for the two dimensions that are not displayed in the horizontal subscript display area are displayed in combinations in order.	---	
(l)	Change Page	You can scroll the page either vertically or horizontally. Each page displays 26 items vertically and 20 items horizontally. To change the page, enter the page number and press the Enter Key. You can click the Change Page Buttons to change the page by half pages (▶) or whole pages (◀).	Supported.	
(m)	Present value table	The present values of the structure members or array elements are displayed. If a structure variable or structure array variable is displayed, you can select the members to display in the present value table. Right-click in the present value table and select Select Structure Members to Display .	Supported.	
(n)	Wrapping position	You can set the position at which to wrap the present value table for a one-dimensional array. Enter the wrapping position, and click the Update Button.	Supported.	This item and button are displayed only for a one-dimensional array variable with a basic data type or a one-dimensional array variable that is an enumeration.
(o)	Array element jump settings	Used to jump to a specified element. Enter the array subscripts and click the Go to Button to move to the specified element.	Supported.	

● Registering Variables in the Watch Tab Page

There are two ways to register variables.

Method (1) Enter the variable name in the name cell in the Watch Tab Page.

Method (2) Drag the variable to the Watch Tab Page from an editor or variable table.

● Method (1) Entering the Variable Name in the Name Cell in the Watch Tab Page

- 1 Specify the *device name* and click the cell that says *Input Name* at the bottom of the Watch Tab Page.
- 2 Enter the variable name to display the present value.
- 3 As you enter characters, a list of candidate variable names is displayed. Select the variable name from the list.
The variable name is registered.

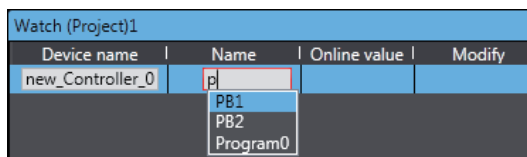

● Method (2) Dragging Variables to the Watch Tab Page from an Editor or Variable Table

The procedure to register variables from the ST Editor is given below. Go offline to perform this procedure.

- 1 Select the required variable in the ST Editor and drag it to the cell that says *Input Name* at the bottom of the Watch Tab Page.

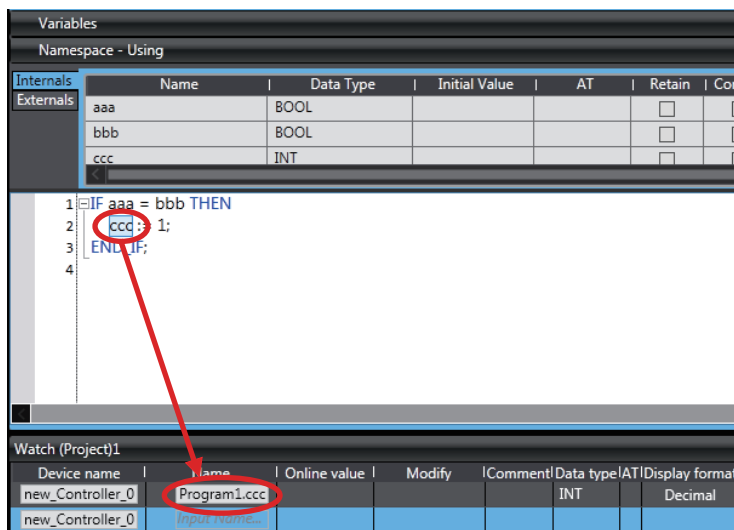

The variable name is registered.

Dragging Variables to the Watch Tab Page

Source	Item	Operation
Ladder Editor	Program input or output	The variable name that is assigned to the input or output is registered.
	Function or function block	The function block instance variable and the input, output, and in-out variables that are assigned in the function or function block are registered.

Source	Item	Operation
ST Editor	Variable name	The specified variable name is registered.
Global variable table or local variable table	Variable or function block instance name in the variable table	The specified variable name or function block instance name is registered.

Format to Register Variables

The formats that you use to enter *variable names* are given below.

(1) Formats for Global and Local Variables

Variable	Format to enter	Example
Global variables	Variable name	Start_SW1
Local variable for program	Program_name.variable_name	Program1.Start_SW1

(2) Formats for Different Data Types

Variable data type	Format to enter	Display
Basic data types	Variable name	The specified variable is displayed.
Arrays	array_variable_name	If you register an array variable in a Watch Tab Page (Table), the array elements are displayed in a tabular format.
	array_variable_name[number]	The specified element is displayed.
	array_variable_name[number-number] or array_variable_name[number..number] (range specification)	The elements in the specified range are compressed on the display.
	array_variable_name[integer_variable_name] ^{*1*2}	The specified element is displayed.
Structures	structure_variable_name	The structure members are compressed on the display. ^{*3} In the Watch Tab Page (Table), the members are displayed in a tabular format.
	structure_variable_name.member_name	The specified member is displayed. ^{*3}
Unions	union_variable_name	The union members are compressed on the display. ^{*3}
	union_variable_name.member_name	The specified member is displayed. ^{*3}
POU instance of function or function block	POU_instance_variable_name	The variables in the POU are compressed on the display.
	POU_instance_variable_name.variable_name_in_POU ^{*4*5}	The specified variable is displayed.
Enumerations	variable_name	The specified variable is displayed.

*1. You can use a variable for an array subscript to specify an element for up to a three-dimensional array. Example for a Three-dimensional Array: Array/Var[index1,index2,index3] (The following are integer variables: index1 to index3.)

*2. You can also use variables for subscripts to specify array elements and members in structure array variables and union array variables.

Example for the Member of a Structure/Union Two-dimensional Array Variable: StructArrayVar[index1,index2].member (The following are integer variables: index1 and index2.)

- *3. The member variable comments are displayed for structure variable and union variable members. If the member variable comment is empty, the data type comment for the member is displayed. If both the member variable comment and the data type comment are empty, the variable comment for the structure variable or union variable to which the member belongs is displayed.
- *4. For input variables in function blocks, you cannot monitor the present values of the input variables for which default initial values are not applied. A *hyphen* is displayed for the present value. Refer to the *NJ/NX-series Instructions Reference Manual (Cat. No. W502)* or *NY-series Instructions Reference Manual (Cat. No. W560)* for information on input variables for which default initial values are not applied.
- *5. The operation of monitoring the present values of in-out variables in function block instances differs depending on the combination of the Sysmac Studio version and the project unit version of the model. Refer to *Monitoring the Present Values of In-Out Variables in Function Block Instances* on page 7-7 for the version combinations.

● Changing the Display Format of a Present Value in the Watch Tab Page

If the Sysmac Studio is online with a Controller in Monitor Mode, the present value of a variable is displayed when the variable name is registered. You can use the *Display format* Column to change the display format of the present value. The *display formats* that you can select depend on the *data type*.

Display Formats

Display format	Description
Boolean	TRUE or FALSE
Binary	Groups of four digits are displayed. The groups are separated by single-byte spaces.
Decimal	For signed decimal, "+x_xxx_xxx" is displayed. ("x_xxx_xxx" is the present value. If the value is negative, "-" is displayed instead of "+".) For unsigned decimal, "x_xxx_xxx" is displayed. ("x_xxx_xxx" is the present value. There is no sign.)
Hexadecimal	The value is displayed in hexadecimal.
Real (floating-point)	Zero: 0.0 Subnormal Number: The conversion results based on display specifications for normalized numbers is displayed. Normalized Number: (sign) decimal_mantissa e decimal_exponent (with no spaces) (The mantissa is 17 digits for a LREAL number and 9 digits for a REAL number.) Example: +1.2345678901234567e-17 Infinity: The conversion results based on display specifications for normalized numbers is displayed.
String	The text string for the UTF-8 text is displayed.
Duration	(- negative value) xxx d yy h zz m uu s vvv.vvvv ms (with no spaces) xxx is the number of days, yy is the number of hours, zz is the number of minutes, uu is the number of seconds, and vvv.vvv is the number of milliseconds. Leading zeros are not displayed. If a number for one of the units is 0, 0 is displayed with the unit. However, if there are no numbers on the left of a 0 number that are not 0, then 0 and the unit are not displayed. Example for 5 minutes, 0 seconds, and 23 milliseconds 5m0s23ms
Date	yyyy-mm-dd Leading zeros are displayed. Example for August 17, 2010 2010-08-17-13:00:05.00
Time of day	hh:nn:ss.ss Leading zeros are displayed.
Date and time	yyyy-mm-dd-hh:nn:ss.ss Leading zeros are displayed.
ASCII	The values of variables are displayed in ASCII values.

Data Types and Supported Display Formats

Data type	Display format (The default formats are set in bold text.)
BOOL	Boolean , Decimal, Hexadecimal, String, or Binary
SINT	Decimal , Boolean, Hexadecimal, or Binary
USINT	Decimal , Boolean, Hexadecimal, or Binary
INT	Decimal , Boolean, Hexadecimal, or Binary
UINT	Decimal , Boolean, Hexadecimal, or Binary
DINT	Decimal , Boolean, Hexadecimal, or Binary
UDINT	Decimal , Boolean, Hexadecimal, or Binary
LINT	Decimal , Boolean, Hexadecimal, or Binary
ULINT	Decimal , Boolean, Hexadecimal, or Binary
BYTE	Hexadecimal , Boolean, Decimal, Binary, or ASCII
WORD	Hexadecimal , Boolean, Decimal, Binary, or ASCII
DWORD	Hexadecimal , Boolean, Decimal, or Binary
LWORD	Hexadecimal , Boolean, Decimal, or Binary
REAL	Real
LREAL	Real
TIME	String (Time)
DATE	String (Date)
TIME_OF_DAY	String (Time of day)
DATE_AND_TIME	String (Date and time)
STRUCT	Depends on the data type of the members.
UNION	Depends on the data type of the members.
STRING	String
ENUM	Decimal, String

Changing the Display Format

Select the **display format** from the Display format Column on the Watch Tab Page.

The present value changes to the specified **display format**.

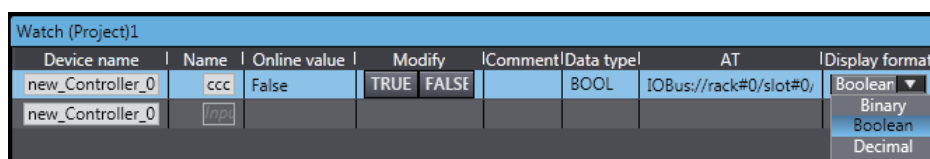

Present Value Displays When Using a Variable for a Subscript to Specify an Array Element

If you use a variable for a subscript to specify an array element or member in an array variable, structure array variable, or union array variable, the present value is displayed as follows (example for a two-dimensional array): *PV_of_variable_element_or_member, [subscript_value, subscript_value]*.

Variable name entry format example for global variables	Present value display
ArrayVar[index1,index2,index3]	Value_of_ArrayVar[index1,index2,index3], [value_of_index1, value_of_index2, value_of_index3]
StructArrayVar[index1,index2].member	Value_of_StructArrayVar[index1,index2].member, [value_of_index1, value_of_index2]

Variable name entry format example for global variables	Present value display
StructArrayVar[index1,index2].member[0,index3]	Value_of_StructArrayVar[index1,index2].member[0,value_of_index3], [value_of_index1, value_of_index2],[0, value_of_index3]

● Deleting Variable Names from the Watch Tab Page

- 1 Right-click the line of a variable name to delete on the Watch Tab Page and select **Delete** from the menu. Or, press the Backspace Key to delete the device name for the variable to delete.

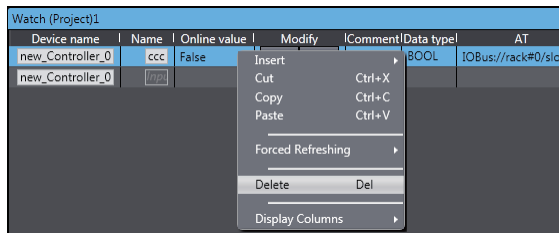

The variable name and the row it was displayed on are deleted.

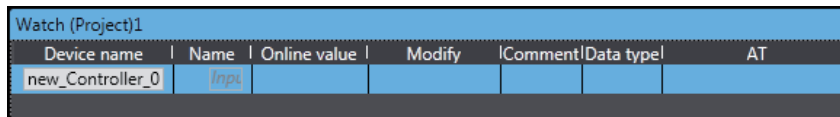

● Copying and Pasting Variable Names from the Watch Tab Page

- 1 Right-click the variable name to copy on the Watch Tab Page and select **Copy** (or press the Ctrl + C Keys).
- 2 Right-click the row at which to insert the copied row on the Watch Tab Page and select **Paste** from the menu (or press the Ctrl + V Keys).
The copied variable name is registered.

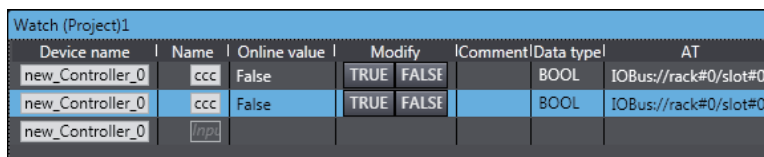

Additional Information

You can copy variable names from a Watch Tab Page and paste them into a spreadsheet (e.g., Excel).

● Adding a Watch Tab Page

You can add one or more Watch Tab Pages to the Watch (Project) or Watch (Table).

- 1 Right-click the tab of a Watch Tab Page and select **Add Watch Tab Page** from the menu.

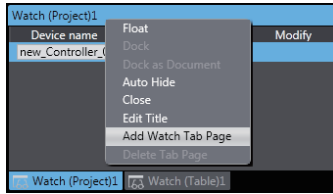

A new Watch Tab Page is added.

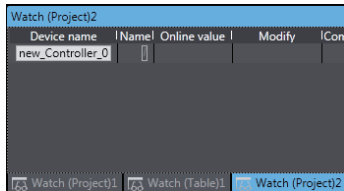

For the Watch (Project), you can add up to 20 Watch Tab Pages, for the Watch (Table), you can add up to 10 Watch Tab Pages.

- 2** To delete a Watch Tab Page, right-click the tab of the Watch Tab Page and select **Delete Tab Page** from the menu.

The specified Watch Tab Page and all variable names that are registered in it are deleted.



Precautions for Correct Use

The display behavior of the Watch Tab Pages differs between Sysmac Studio version 1.19 or lower (between version 1.10 and version 1.19) and Sysmac Studio version 1.20 or higher.

- Maximum number of tab pages

	Watch (Project)	Watch Tab Page	Watch (Table)
Version 1.19 or lower	1 max.	9 max.	9 max.
Ver.1.20 or Ver.1.21	10 max.	Not provided	10 max.
Version 1.22 or later	20 max.		

- If you open a project that was saved in a different version of Sysmac Studio, the data that is registered in a Watch Tab Page is displayed as follows.

If a project that was saved in Sysmac Studio version 1.19 or lower is opened in version 1.20, 1.21, 1.22 or higher

Registration location of data	Display location in version 1.20 or 1.21	Display location in version 1.22 or higher
Watch (Project)	The data is displayed in the <i>Watch (Project) 1</i> .	
Watch Tab Page for each device - Watch Tab Page 1, Watch Tab Page 2, ...	The data registered in the Watch Tab Pages for all the devices are displayed in the <i>Watch (Project) 1</i> .	Data registered in the Watch Tab Pages for devices are displayed in the <i>Watch (Project) 2</i> , <i>Watch (Project) 3</i> , When variables are not registered in the Watch (Project) for a project saved using version 1.19 or lower, data in the Watch Tab Pages such as the Watch Tab Page 1 and Watch Tab Page 2 are displayed in the <i>Watch (Project) 1</i> , <i>Watch (Project) 2</i> , In the order in which the devices were registered and the Watch Tab Pages were added in a project saved using version 1.19 or lower, data for a maximum of 20 Watch Tab Pages including the Watch (Project) are displayed. Additional data after the maximum number of Watch Tab Pages is reached will be all displayed in the 20th page - the <i>Watch (Project) 20</i> .
Watch (Table)	The data that is registered in the <i>Watch Tab Pages</i> for each Controller is displayed in the <i>Watch (Table) 1</i> , <i>Watch (Table) 2</i> ,	

If a project that was saved in version 1.20 or higher is opened in version 1.19 or lower

Registration location of data	Display location in version 1.19 or higher
Watch (Project) 1, Watch (Project) 2, ...	Only the data that is registered in the <i>Watch (Project) 1</i> (the first Watch (Project) that was created) is displayed in the <i>Watch (Project)</i> . Data in the <i>Watch (Project) 2</i> and later is not displayed.
Watch (Table) 1, Watch (Table) 2, ...	No data is displayed.

Monitoring in the I/O Map

● Monitoring in the I/O Map

You can monitor the present values of Unit I/O ports in the I/O Map when the Sysmac Studio is online with a Controller.

● Monitor Displays in the I/O Map

- 1 Double-click **I/O Map** under **Configurations and Setup** on the Multiview Explorer. The I/O Map is displayed. The present values of the registered Unit I/O ports are displayed in the **Variable** Column.

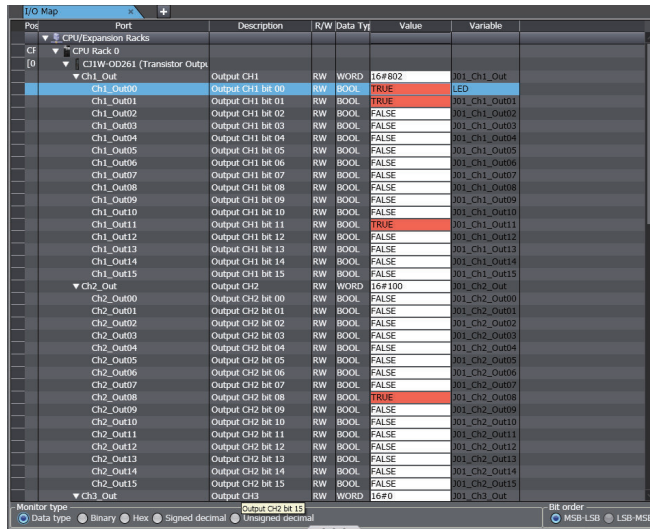

The data types that are given in the following table can be monitored in the I/O Map.

- Data Types and Present Value Displays in the I/O Map

Data type	Number of bytes	Range
BOOL	2	0 or 1
BYTE	1	16#00 to FF
WORD	2	16#0000 to FFFF
DWORD	4	16#00000000 to FFFFFFFF
LWORD	8	16#0000000000000000 to FFFFFFFFFFFFFFFF
SINT	1	-128 to +127
INT	2	-32768 to +32767
DINT	4	-2147483648 to +2147483647
LINT	8	-9223372036854775808 to +9223372036854775807
USINT	1	0 to +255
UINT	2	0 to +65535
UDINT	4	0 to +4294967295
ULINT	8	0 to +18446744073709551615
REAL	4	-3.40282347e+38 to 3.40282347e+38
LREAL	8	-1.7976931348623157e+308 to 1.7976931348623157e+308

● Changing the Display Format in the I/O Map

- 1 Select the display format from the Monitor Type Area in the I/O Map.

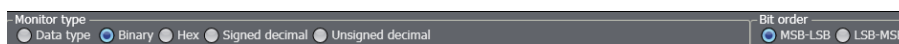

The present value in the **Value** Column changes to the specified display format.

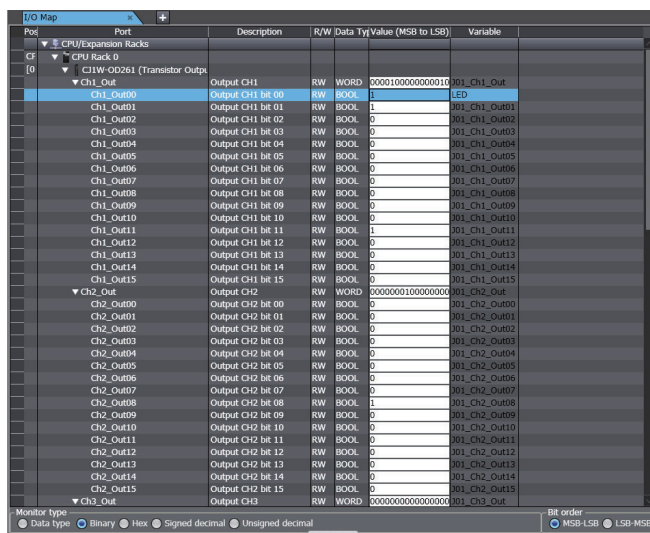

The display formats that you can select for each data type are given in the following table.

Display format	Description	Remarks
Data type	The present value is displayed in the format for the data type.	
Binary	The present value is displayed in binary.	The bit order can also be specified (<i>MSB-LSB</i> or <i>LSB-MSB</i>). (The default bit order is <i>MSB-LSB</i> .)
Hexadecimal	The present value is displayed in hexadecimal.	
Signed decimal	The present value is displayed in signed decimal.	
Unsigned decimal	The present value is displayed in unsigned decimal.	



Additional Information

- Structures and arrays cannot be monitored.
- REAL and LREAL data are displayed in the REAL and LREAL data formats even if the monitor type is changed.

7-2-2 Differential Monitor

With the Differential Monitor, you can detect the number of times a specified BOOL variable or BOOL member changes to TRUE or changes to FALSE and display the count in the Differential Monitor. You can check if bits turn ON and OFF and the number of times that they turn ON and OFF.



Version Information

A CPU Unit with unit version 1.03 or later and Sysmac Studio version 1.04 or higher are required to use differential monitoring.

Refer to the *NJ/NX-series CPU Unit Software User's Manual (Cat. No. W501)* or *NY-series Industrial Panel PC / Industrial Box PC Software User's Manual (Cat. No. W558)* for information on differential monitoring.

Opening the Differential Monitor Tab Page

- 1 Right-click the BOOL variable to register in the Differential Monitor in the Ladder Editor and select **Add to Differential Monitor** from the menu. Or, select **Differential Monitor** from the **View** Menu or click the Differential Monitor Button () on the toolbar.

The Differential Monitor is displayed.

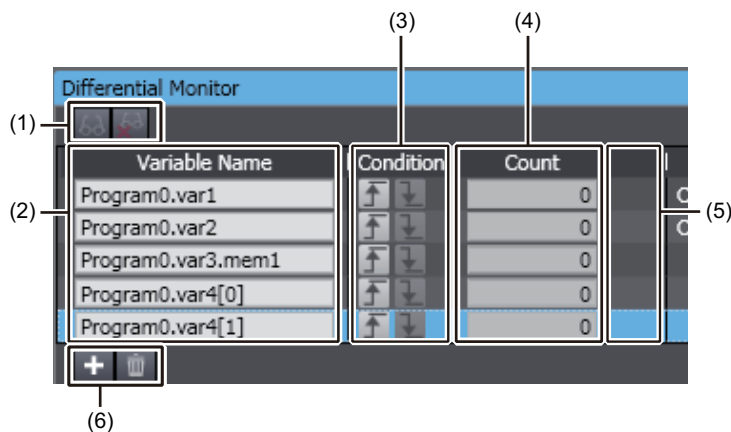

Parts of the Pane

No.	Part	Description
1	Start Differential Monitor and Stop Differential Monitor Buttons	Click these buttons to start and stop differential monitoring.
2	Variable Name	Enter the variables for differential monitoring.
3	Differentiation Condition Buttons	Click these button to specify whether to detect changes to TRUE (rising) or changes to FALSE (falling).
4	Count	This column displays the number of times the condition for the variable was met (change to TRUE or change to FALSE).
5	Condition Satisfied Indicators	These indicators flash when the conditions for the variables are met (change to TRUE or change to FALSE).
6	Add Item and Delete Item Buttons	Click these buttons to add and delete selected variables for differential monitoring.

Entering Differentiation Conditions

- 1 You can drag variables from the Ladder Editor, the ST Editor, or a variable table to the Differential Monitor. You can also right-click the variables to monitor in the Ladder Editor and select **Add to Differential Monitor** from the pop-up menu.
The variables for differential monitoring are registered.

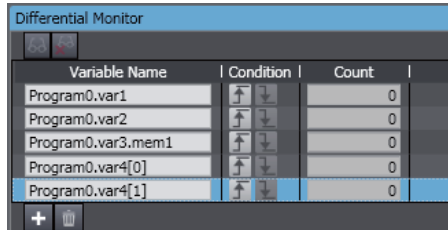

You can register up to eight variables for differential monitoring.



Additional Information

You can also click the *Add Variable* Button in the Differential Monitor Tab Page to add variables.

Executing Differential Monitoring

- 1 Click the Start Differential Monitor Button () in the Differential Monitor Tab Page. Differential monitoring is started and the number of times the condition (change to TRUE or change to FALSE) is met is displayed in the count list for each variable.

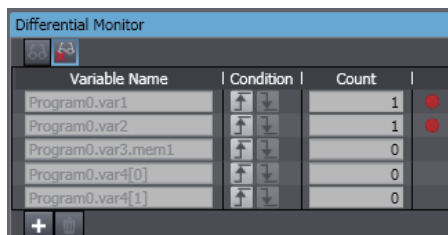

Additional Information

- The values in count list are reset to zero every time the Start Differential Monitor Button is clicked.
- You can add variables for differential monitoring while differential monitoring is under execution. To monitor the variables that you add, stop differential monitoring and then start it again.

Stopping Differential Monitoring

- 1 Click the Stop Differential Monitor Button in the Differential Monitor Tab Page during differential monitoring. Differential monitoring stops.

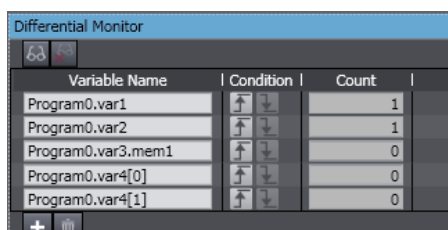

**Precautions for Correct Use**

You can register variables for another Controller in the same project for differential monitoring. However, only the variables for the Controller that is currently selected are actually monitored when differential monitoring is executed.

7-2-3 Changing Present Values and Set/Reset Using Forced Refreshing

● Changing Present Values and Set/Reset Using Forced Refreshing

You can change the values of variables that are used in the user program and settings to any desired value, and you can use the Set/Reset command to change program inputs and outputs to TRUE or FALSE. This allows you to check the operation of the user program and settings.

WARNING

Sufficiently confirm safety before you change the values of I/O ports or variables on the I/O Map when the Sysmac Studio is online with the CPU Unit. Incorrect operation may cause the devices that are connected to Output Units to operate regardless of the operating mode of the Controller.



CAUTION

- Always confirm the safety at the destination node before you transfer a user program to a node or perform an operation that changes device variables. Not doing so may result in injury.
- Sufficiently confirm safety before you change the values of variables on a Watch Tab Page when the Sysmac Studio is online with the CPU Unit. Incorrect operation may cause the devices that are connected to Output Units to operate regardless of the operating mode of the Controller.

**Precautions for Safe Use**

Always confirm the safety of the system before you perform forced refreshing.

Controlling BOOL Variables

● Controlling BOOL Variables

You can change the value of any BOOL variable to TRUE or FALSE. The specified value is then overwritten by the execution results of the user program. If the operating mode is changed or the power supply is cycled, the initial value is restored.

You can control BOOL variables in the Ladder Editor, Watch Tab Page, or I/O Map.

**Additional Information**

- Go online and select **Monitor** from the **Controller** Menu to enter monitor status before you perform the following procedure.
- On the ST Editor, the procedure that is given below in *Changing the Present Values of Variables* on page 7-27 is used to set/reset BOOL variables.

● Controlling BOOL Variables in the Ladder Editor (Set/Reset)

- Controlling BOOL Variables in the Ladder Editor (Set/Reset)

You can use the Set and Reset menu commands to change program inputs and outputs in the Ladder Editor to TRUE or FALSE.

- Procedure

1 Double-click the ladder program, ladder function, or ladder function block under **Programming** in the Multiview Explorer.

The rungs are displayed on the Ladder Editor in monitor status.

2 Right-click the input or output and select **Set/Reset – Set** to change the input or output to TRUE. Or, right-click the input or output and select **Set/Reset – Reset** to change the input or output to FALSE.

The input or output in the Ladder Editor changes to TRUE or FALSE and the execution condition changes accordingly.

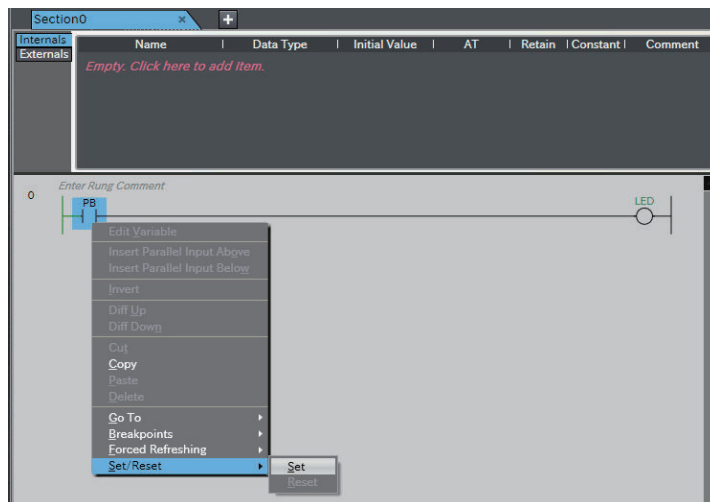

● Controlling BOOL Variables in the Watch Tab Page (Set/Reset)

Controlling BOOL Variables in the Watch Tab Page (Set/Reset)

You can change the status of BOOL variables that are registered in a Watch Tab Page to TRUE or FALSE.

The monitor values in the Watch Tab Page change to TRUE or FALSE.

Procedure

1 Select **Watch Tab Page** from the **View** Menu to display a Watch Tab Page.

The rungs are displayed on the Ladder Editor in monitor status.

2 Select a BOOL variable in the Watch Tab Page.

3 Select **TRUE** in the **Modify** Column to change the variable to TRUE. Select **FALSE** in the **Modify** Column to change the variable to FALSE.

The value in the Online value Column changes to **TRUE** or **FALSE**.

Name	Online value	Modify	Comment	Data type	AT	Display format
Program0.LED	True	TRUE FALSE		BOOL	IOBus://rack#0	Boolean
Program0.PB	False	TRUE FALSE		BOOL	IOBus://rack#0	Boolean
<input type="text" value="Input Name..."/>						



Additional Information

If the status of a BOOL variable that is used in a ladder diagram is changed, the execution status in the Ladder Editor changes accordingly.

● Controlling Boolean I/O Ports in the I/O Map

Controlling Boolean I/O Ports in the I/O Map

You can change the status of the BOOL I/O ports in the I/O Map.

Procedure

- 1 Double-click **I/O Map** under **Configurations and Setup** on the Multiview Explorer. The I/O Map is displayed.
- 2 Select the BOOL I/O port in the I/O Map.
- 3 Enter TRUE in the **Value** Column to change the variable to TRUE. Enter FALSE in the **Value** Column to change the variable to FALSE.

Pos	Port	Description	R/W	Data Type	Value	Variable
CF	CPU/Expansion Racks					
	CPU Rack 0					
[0]	CJ1W-OD261 (Transistor Output)					
	Ch1_Out	Output CH1	RW	WORD	16#0	J01_Ch1_Out
	Ch1_Out00	Output CH1 bit 00	RW	BOOL	FALSE	J01_Ch1_Out00
	Ch1_Out01	Output CH1 bit 01	RW	BOOL	FALSE	J01_Ch1_Out01
	Ch1_Out02	Output CH1 bit 02	RW	BOOL	FALSE	J01_Ch1_Out02
	Ch1_Out03	Output CH1 bit 03	RW	BOOL	FALSE	J01_Ch1_Out03
	Ch1_Out04	Output CH1 bit 04	RW	BOOL	FALSE	J01_Ch1_Out04
	Ch1_Out05	Output CH1 bit 05	RW	BOOL	FALSE	J01_Ch1_Out05
	Ch1_Out06	Output CH1 bit 06	RW	BOOL	FALSE	J01_Ch1_Out06
	Ch1_Out07	Output CH1 bit 07	RW	BOOL	FALSE	J01_Ch1_Out07
	Ch1_Out08	Output CH1 bit 08	RW	BOOL	FALSE	J01_Ch1_Out08
	Ch1_Out09	Output CH1 bit 09	RW	BOOL	FALSE	J01_Ch1_Out09
	Ch1_Out10	Output CH1 bit 10	RW	BOOL	FALSE	J01_Ch1_Out10
	Ch1_Out11	Output CH1 bit 11	RW	BOOL	FALSE	J01_Ch1_Out11
	Ch1_Out12	Output CH1 bit 12	RW	BOOL	FALSE	J01_Ch1_Out12
	Ch1_Out13	Output CH1 bit 13	RW	BOOL	FALSE	J01_Ch1_Out13
	Ch1_Out14	Output CH1 bit 14	RW	BOOL	FALSE	J01_Ch1_Out14
	Ch1_Out15	Output CH1 bit 15	RW	BOOL	FALSE	J01_Ch1_Out15

The status of the BOOL device variable changes to TRUE or FALSE and the value in the **Value** Column in the I/O Map changes to TRUE or FALSE.

Pos	Port	Description	R/W	Data Type	Value	Variable
CF	CPU/Expansion Racks					
	CPU Rack 0					
[0]	CJ1W-OD261 (Transistor Output)					
	Ch1_Out	Output CH1	RW	WORD	16#1	J01_Ch1_Out
	Ch1_Out00	Output CH1 bit 00	RW	BOOL	TRUE	J01_Ch1_Out00
	Ch1_Out01	Output CH1 bit 01	RW	BOOL	FALSE	J01_Ch1_Out01
	Ch1_Out02	Output CH1 bit 02	RW	BOOL	FALSE	J01_Ch1_Out02
	Ch1_Out03	Output CH1 bit 03	RW	BOOL	FALSE	J01_Ch1_Out03
	Ch1_Out04	Output CH1 bit 04	RW	BOOL	FALSE	J01_Ch1_Out04

Changing the Present Values of Variables

● Changing the Present Values of Variables

You can change the present values of user-defined variables, system-defined variables, and device variables as required. You can do this in the Ladder Editor, ST Editor, Watch Tab Page, or I/O Map.

● Changing Present Values on the Ladder Editor

Changing Present Values on the Ladder Editor

You can change the present values of variables directly on the Ladder Editor.

Procedure

- 1 On the Ladder Editor, right-click a variable and select **Edit Variable Value** or double-click the present value that is displayed for a variable.

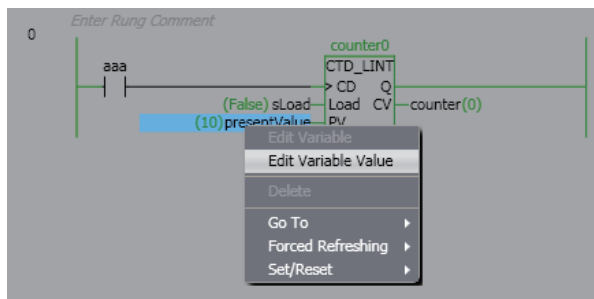

You can now change the present value.

- 2 Enter the new value and press the Enter Key.

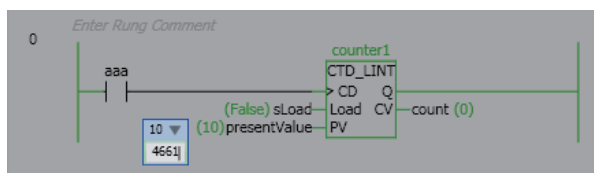

The present value is changed.

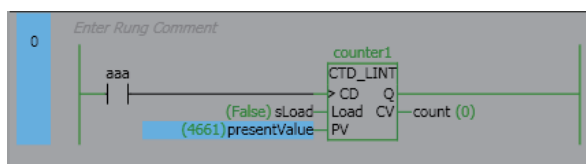

Precautions for Correct Use

If you use a variable for a subscript to specify an array element, a confirmation dialog box is displayed for the element for which the present value is to be changed. Check the present values of the variable for the subscript to make sure that the present value of the correct element will be changed before you click the **OK** Button.

● Changing Present Values on the ST Editor

Changing Present Values on the ST Editor

You can change the present values of variables directly on the ST Editor.

Procedure

- 1 On the ST Editor, click the drop-down arrow for the present value of a variable.
A text box or combo box is displayed below the present value according to the data type of the variable.

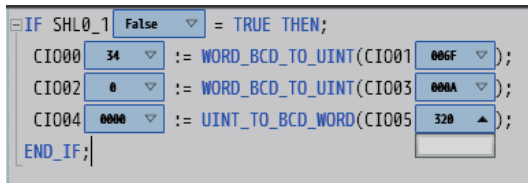

- 2 Enter the new value and press the Enter Key.
The present value is changed.



Precautions for Correct Use

If you use a variable for a subscript to specify an array element, a confirmation dialog box is displayed for the element for which the present value is to be changed. Check the present values of the variable for the subscript to make sure that the present value of the correct element will be changed before you click the **OK** Button.

● Changing Present Values on a Watch Tab Page

Changing Present Values on a Watch Tab Page

You can change the present value of variables that are registered in a Watch Tab Page.

Procedure

- 1 Select **Watch Tab Page** from the **View** Menu to display a Watch Tab Page.
- 2 Move the cursor to the cell in the *Modify* Column on the Watch Tab Page, enter a value that is compatible with the format that is given in the *Display format* Column, and then press Enter Key. Press the Esc Key to cancel entering a value.
The present value is changed.

Watch1						
Name	Online value	Modify	Comment	Data type	AT	Display format
Program0.LED	False	TRUE FALSE		BOOL	IOBus://rack#0	Boolean
Program0.PB	False	TRUE FALSE		BOOL	IOBus://rack#0	Boolean
Program0.a	1	1		INT		Decimal
Program0.b	0001	0001		WORD		Hexadecimal
<input type="text" value="Input Name..."/>						

The format for entering a value in the *Modify* Column depends on the format that is given in the *Display format* Column.

For details, refer to *Display Formats* under *Changing the Display Format of a Present Value in the Watch Tab Page* on page 7-15.

- Examples of Entries in the *Modify* Column:

Display format	Example
Boolean	TRUE or FALSE
Decimal	10, -100
Real (floating-point)	123.4 1.234e2, 1.234E2, -1.23e-3
Hexadecimal	1001, FFFF8000
Binary	11110000
String	abc, ABC
Duration	12345.678, -12345.678
Date	2030-04-05



Precautions for Correct Use

If you use a variable for a subscript to specify an array element, a confirmation dialog box is displayed for the element for which the present value is to be changed. Check the present values of the variable for the subscript to make sure that the present value of the correct element will be changed before you click the **OK** Button.



Additional Information

If you enter an illegal value in the *Modify* Column, an error is detected and the cell is highlighted in red.

● Changing Present Values in the I/O Map

Changing Present Values in the I/O Map

You can change the present value of I/O ports in the I/O Map.

Procedure

- 1** Double-click **I/O Map** under **Configurations and Setup** on the Multiview Explorer. The I/O Map is displayed.
- 2** Select the I/O ports in the I/O Map.
- 3** Enter a value in the *Value* Column.
The present value is changed.

Pos	Port	Description	R/W	Data Type	Value	Variable
CF	CPU Expansion Racks					
	CPU Rack 0					
[0]	CJ1W-OD261 (Transistor Output)					
	Ch1_Out					
	Ch1_Out00	Output CH1 bit 00	RW	WORD	16#1	D01_Ch1_Out
	Ch1_Out00	Output CH1 bit 00	RW	BOOL	TRUE	LED
	Ch1_Out01	Output CH1 bit 01	RW	BOOL	FALSE	D01_Ch1_Out01
	Ch1_Out02	Output CH1 bit 02	RW	BOOL	FALSE	D01_Ch1_Out02
	Ch1_Out03	Output CH1 bit 03	RW	BOOL	FALSE	D01_Ch1_Out03
	Ch1_Out04	Output CH1 bit 04	RW	BOOL	FALSE	D01_Ch1_Out04
	Ch1_Out05	Output CH1 bit 05	RW	BOOL	FALSE	D01_Ch1_Out05
	Ch1_Out06	Output CH1 bit 06	RW	BOOL	FALSE	D01_Ch1_Out06
	Ch1_Out07	Output CH1 bit 07	RW	BOOL	FALSE	D01_Ch1_Out07
	Ch1_Out08	Output CH1 bit 08	RW	BOOL	FALSE	D01_Ch1_Out08
	Ch1_Out09	Output CH1 bit 09	RW	BOOL	FALSE	D01_Ch1_Out09
	Ch1_Out10	Output CH1 bit 10	RW	BOOL	FALSE	D01_Ch1_Out10
	Ch1_Out11	Output CH1 bit 11	RW	BOOL	FALSE	D01_Ch1_Out11
	Ch1_Out12	Output CH1 bit 12	RW	BOOL	FALSE	D01_Ch1_Out12
	Ch1_Out13	Output CH1 bit 13	RW	BOOL	FALSE	D01_Ch1_Out13
	Ch1_Out14	Output CH1 bit 14	RW	BOOL	FALSE	D01_Ch1_Out14
	Ch1_Out15	Output CH1 bit 15	RW	BOOL	FALSE	D01_Ch1_Out15
	Ch2_Out	Output CH2	RW	WORD	16#0	D01_Ch2_Out
	Ch2_Out00	Output CH2 bit 00	RW	BOOL	FALSE	D01_Ch2_Out00
	Ch2_Out01	Output CH2 bit 01	RW	BOOL	FALSE	D01_Ch2_Out01
	Ch2_Out02	Output CH2 bit 02	RW	BOOL	FALSE	D01_Ch2_Out02
	Ch2_Out03	Output CH2 bit 03	RW	BOOL	FALSE	D01_Ch2_Out03
	Ch2_Out04	Output CH2 bit 04	RW	BOOL	FALSE	D01_Ch2_Out04
	Ch2_Out05	Output CH2 bit 05	RW	BOOL	FALSE	D01_Ch2_Out05
	Ch2_Out06	Output CH2 bit 06	RW	BOOL	FALSE	D01_Ch2_Out06

Refer to *Monitoring in the I/O Map* on page 7-19 for the formats to enter.



Additional Information

If the value is entered in the wrong format, an error occurs. The illegal values are highlighted in red and an error icon is displayed. Place the mouse over the error icon to view the error details.

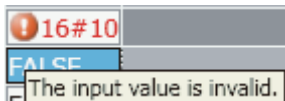

Forced Refreshing

● Forced Refreshing

Forced refreshing allows the user to refresh external inputs and outputs with user-specified values from the Sysmac Studio to debug the system.

Forced refreshing is executed not for the specified device variables, but for the I/O ports that are assigned to the device variables.

The state that is specified with forced refreshing is retained until forced refreshing is cleared from the Sysmac Studio. Refer to the *NJ/NX-series CPU Unit Software User's Manual (Cat. No. W501)* or *NY-series Industrial Panel PC / Industrial Box PC Software User's Manual (Cat. No. W558)* for details on holding and clearing status changes in the CPU Unit.

All forced refreshing is cancelled when a fatal error occurs, when a Clear All Memory operation is performed, when the operating mode is changed, when power is interrupted, or when the project is downloaded.

CAUTION

Sufficiently confirm safety at the connected slave or Unit before you change the value of an I/O port or device variable.
Not doing so may result in injury.





Precautions for Safe Use

- Confirm that no adverse effect will occur in the system before you use forced refreshing.
- Forced refreshing ignores the results of user program execution and refreshes I/O with the specified values.
If forced refreshing is used for program inputs for which it is not supported, the program inputs will first take the specified values, but they will then be overwritten by the user program.
- Discrepancies in the forced status may cause unexpected operation of the controlled system.



Precautions for Correct Use

If you use a variable for a subscript to specify an array element, a confirmation dialog box is displayed for the element for which the forced status is to be changed. Check the values of the variable for the subscript to make sure that the correct element will be changed before you click the OK Button.

● Forced Refreshing and Canceling Forced Refreshing in the Ladder Editor

Forced Refreshing and Canceling Forced Refreshing in the Ladder Editor

Forced refreshing forces a program input or output to TRUE or FALSE in the Ladder Editor. Canceling forced refreshing removes the forced TRUE/FALSE values of the inputs and outputs.

Procedure for Forced Refreshing in the Ladder Editor

- 1 Double-click the ladder program or ladder function block under **Programming** in the Multiview Explorer.

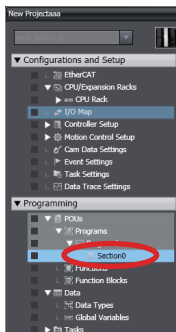

The rungs are displayed on the Ladder Editor.

- 2 Right-click the program input or output and select **Forced Refreshing - TRUE**. The input or output is forced to TRUE. Right-click the program input or output and select **Forced Refreshing - FALSE**. The input or output is forced to FALSE.

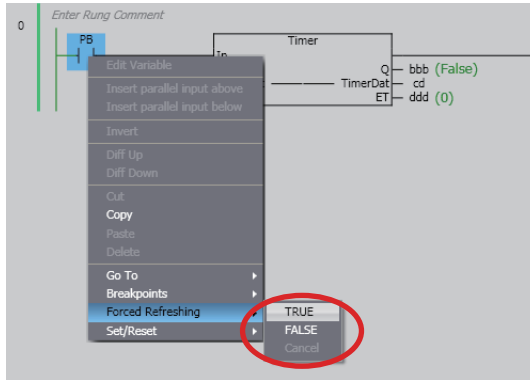

The input or output in the Ladder Editor changes to TRUE or FALSE and the execution condition changes accordingly.

An icon also appears by the input or output that represents its current forced value.

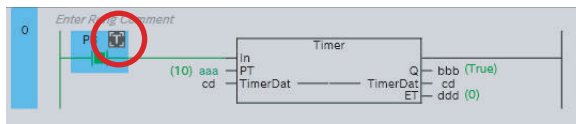

● Procedure to Cancel Forced Refreshing from the Ladder Editor

- 1 Right-click the program input or output to clear in the Ladder Editor and select **Forced Refreshing - Cancel**.

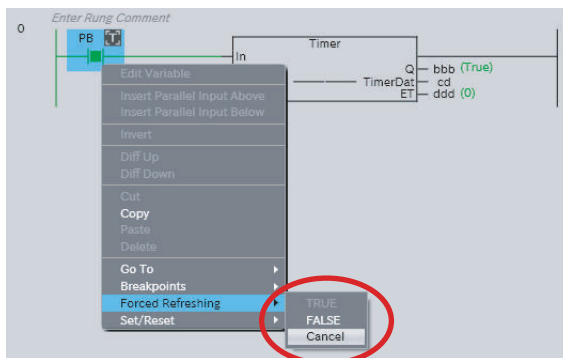

The forced value for the selected input or output is cleared and the forced value icon disappears.

The TRUE/FALSE value does not change.

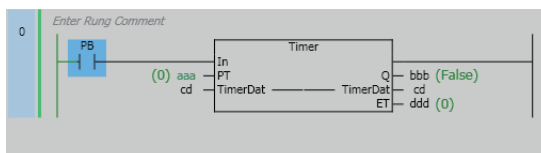

Additional Information

To cancel the forced status of all inputs and outputs, right-click and select **Forced Refreshing - Cancel All**.

● **Forced Refreshing and Clearing Forced Refreshing on a Watch Tab Page**

Forced Refreshing and Clearing Forced Refreshing on a Watch Tab Page

You can force the I/O ports or memory addresses for CJ-series Units that are assigned to BOOL variables that are registered on a Watch Tab Page to TRUE or FALSE and clear the forced values on the Watch Tab Page.

Procedure for Forced Refreshing on a Watch Tab Page

- 1 Select **Watch Tab Page** from the **View** Menu.

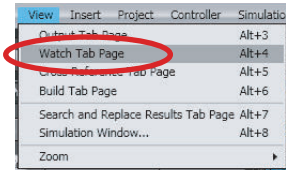

A Watch Tab Page is displayed.

- 2 Select a BOOL variable in the Watch Tab Page.

Name	Online value	Modify	Comment	Data type	AT	Display format
Program0.LED	False	TRUE FALSE		BOOL	IOBus://rack#0	Boolean
Program0.PB	False	TRUE FALSE		BOOL	IOBus://rack#0	Boolean
Program0.a	1	1		INT		Decimal
Program0.b	0001	0001		WORD		Hexadecimal

- 3 Right-click the BOOL variable and select **Forced Refreshing – TRUE** from the menu. The I/O port or memory address is forced to TRUE. Right-click the BOOL variable and select **Forced Refreshing - FALSE** from the menu. The I/O port or memory address is forced to FALSE.

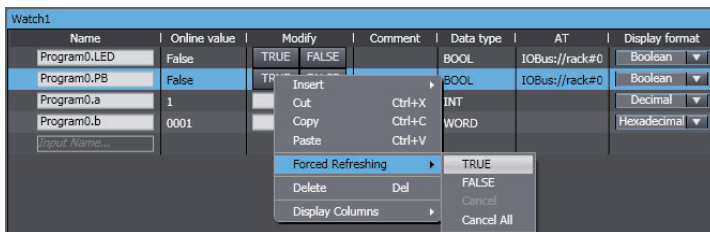

The present value is displayed in the Watch Tab Page as shown below.

- When you select **TRUE: True**
- When you select **FALSE: False**

An icon also appears by the BOOL variable that represents its current forced value.

Name	Online value	Modify	Comment	Data type	AT	Display format
Program0.LED	True	TRUE FALSE		BOOL	IOBus://rack#0	Boolean
Program0.PB	True	TRUE FALSE		BOOL	IOBus://rack#0	Boolean
Program0.a	1	1		INT		Decimal
Program0.b	0001	0001		WORD		Hexadecimal

● Procedure for Canceling Forced Refreshing in a Watch Tab Page

- 1 Right-click the BOOL variable on the Watch Tab Page, and then select **Forced Refreshing - Cancel**.

The forced value for the selected BOOL variable is canceled and the forced value icon disappears.

The TRUE/FALSE value does not change.

Name	Online value	Modify	Comment	Data type	AT	Display format
Program0.LED	True	TRUE FALSE		BOOL	IOBus://rack#0	Boolean
Program0.PB	True	TRUE FALSE		BOOL	IOBus://rack#0	Boolean
Program0.a	1	1		INT		Decimal
Program0.b	0001	0001		WORD		Hexadecimal



Additional Information

To cancel the forced status of all BOOL variables, right-click and select **Forced Refreshing - Cancel All**.

● Forced Refreshing and Canceling Forced Refreshing in the I/O Map

Forced Refreshing and Canceling Forced Refreshing in the I/O Map

You can force the I/O ports of BOOL device variables to TRUE or FALSE in the I/O Map.

Procedure for Forced Refreshing in the I/O Map

- 1 Double-click I/O Map under **Configurations and Setup** in the Multiview Explorer or right-click **I/O Map** and select **Edit** from the menu.

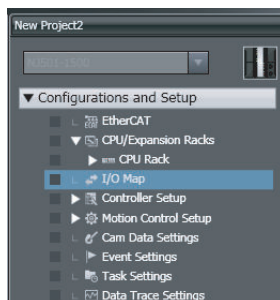

The I/O Map is displayed.

- 2 Select the BOOL device variable in the I/O Map.

Pos	Port	Description	R/W	Data Ty	Variable	Variable Comment	Variable Type
01		CPU/Expansion Racks					
02		CPU Rack 0					
03		Q11W-00222 (Transistor Outp					
		Ch1_Out					
		Output CH1	RW	WORD			
		Ch1_Out00	RW	BOOL	Out_00		
		Output CH1 bit 00	RW	BOOL	Out_00		
		Ch1_Out01	RW	BOOL	Out_01		
		Output CH1 bit 01	RW	BOOL	Out_01		
		Ch1_Out02	RW	BOOL	Out_02		
		Output CH1 bit 02	RW	BOOL	Out_02		
		Ch1_Out03	RW	BOOL	Out_03		
		Output CH1 bit 03	RW	BOOL	Out_03		
		Ch1_Out04	RW	BOOL	Out_04		
		Output CH1 bit 04	RW	BOOL	Out_04		
		Ch1_Out05	RW	BOOL	Out_05		
		Output CH1 bit 05	RW	BOOL	Out_05		

- 3 Right-click the BOOL variable and select **Forced Refreshing - TRUE** from the menu. The I/O port is forced to TRUE.

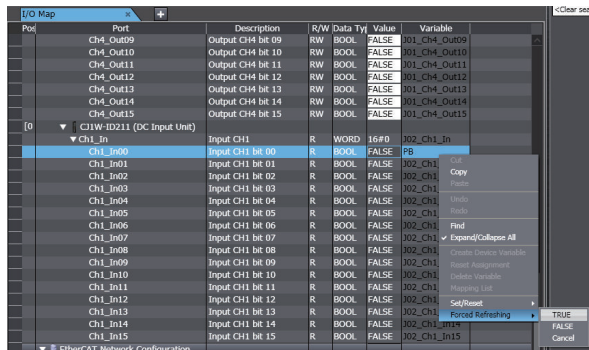

Or, right-click the BOOL variable and select **Forced Refreshing - FALSE** from the menu. The I/O port is forced to FALSE.

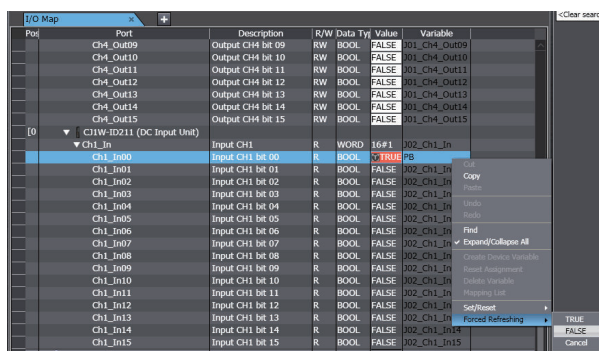

After you force the BOOL device variable to TRUE or FALSE, the value in the **Value** column in the I/O Map changes to TRUE or FALSE to reflect that change.

An icon also appears by the BOOL device variable that represents its current forced value.

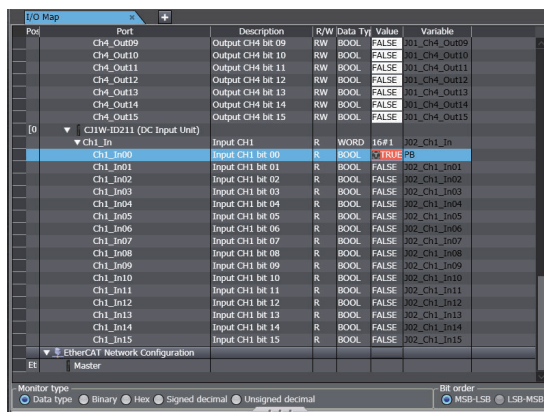

● Procedure for Canceling Forced Refreshing from the I/O Map

- 1 Right-click the BOOL I/O ports in the I/O Map, and then select **Forced Refreshing - Cancel**.

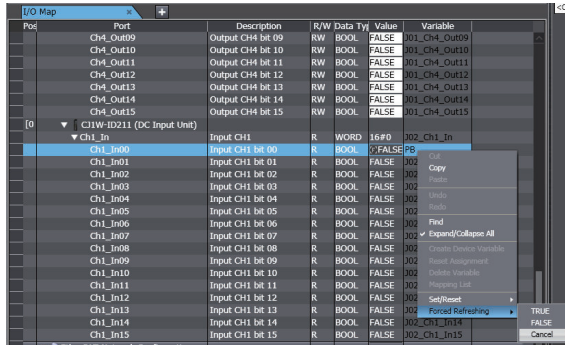

The forced value for I/O port of the selected BOOL device variable is cleared and the forced value icon disappears.

The TRUE/FALSE value does not change.

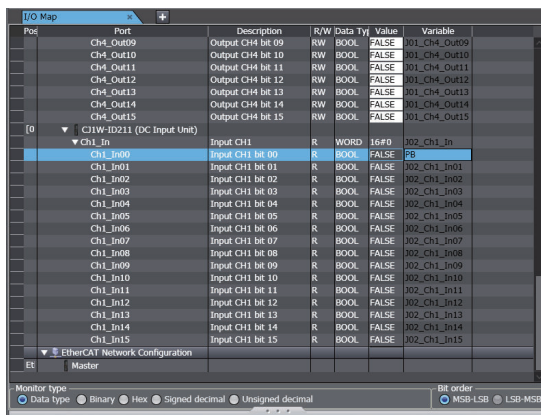

● Procedure to Clear All Forced Refreshing

- 1 Select **Forced Refreshing - Cancel All** from the **Controller** Menu to clear all of the forced refreshing.

7-2-4 Cross References

Cross References

Cross references allow you to see the programs and locations where program elements of the Controller are used.

You can view all locations where an element is used from this list.

The following elements can be cross-referenced.

- Variables
- Data types
- I/O ports
- Functions
- Function blocks

Displaying and Manipulating Cross References

- 1 Select **Cross Reference Tab Page** from the **View** Menu.
The Cross Reference Tab Page is displayed.
- 2 Select a referenced element.
The name of the selected referenced element is displayed in the Reference Target field, and the locations where the element is used are listed under Cross Reference.
If the referenced element is a variable or a member of a variable, you can directly enter the variable name or member name in the Reference Target field.
Refer to *Referenced Element You Can Select* on page 7-38 for the elements you can select for reference.
For the areas where cross reference can be performed, refer to *Areas for Cross Reference* on page 7-39.

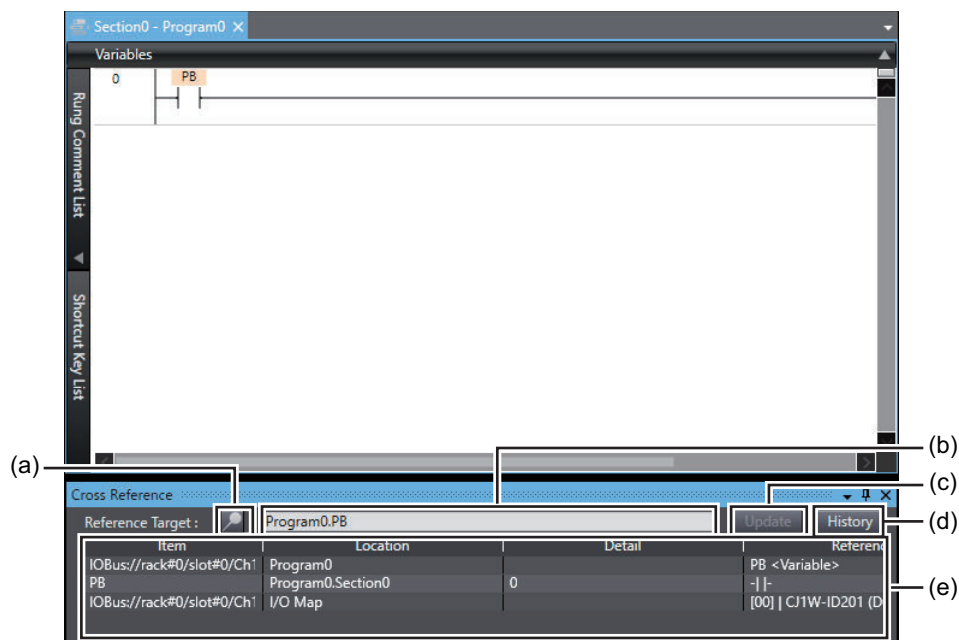

	Item	Description
(a)	Lock Button	Click this button to lock the display of the referenced element and cross reference list. Click the button again to release the lock.
(b)	Reference Target field	The referenced element that is currently selected is displayed. Or, you can directly enter a variable name or variable member name as the reference target in this field.*1
(c)	Update Button	This button is enabled only after the lock button is clicked and the display is locked. When the Update Button is clicked, the cross reference list is updated.
(d)	History Button	Click the History Button to display a dialog box that displays the history of the referenced element. In the Reference History Dialog Box, you can select referenced elements that you previously searched for.

	Item	Description
(e)	Cross reference list	The locations in which the referenced element is used are displayed. Refer to <i>Cross Reference List Details</i> on page 7-39, below, for details on items in the list.

- *1. Note that an error occurs if the following variables are entered. Also, an error occurs if the directly entered element is not a variable.
- A variable in a POU that is protected with the display prohibition setting
 - A variable in a library for which the Disable Source Display setting is used
 - A variable in a library for which the Do Not Publish setting is used

Referenced Element You Can Select

The following table shows the referenced elements you can select and the locations from which you can select the referenced elements. You can select only the elements displayed with a focus in the following locations.

	Element	Location
Variable	Global variable, axis variable, axes group variable, cam data variable, and external variable	<ul style="list-style-type: none"> • Global variable table • External variable tab in local variable tables (when you select external variables) • Input, output, I/O parameter of functions, or I/O parameter of function blocks on the Ladder Editor • ST Editor • Axis or axes group in the Multiview Explorer (when you select axis or axes group variables) • Cam profile in the Multiview Explorer (when you select cam data variables) • Trace target variable table for data tracing
	System-defined variable	<ul style="list-style-type: none"> • Input, output, I/O parameter of functions, or I/O parameter of function blocks on the Ladder Editor • ST Editor • Trace target variable table for data tracing
	Internal variable, input variable, output variable, and inout variable	<ul style="list-style-type: none"> • Internal variable tab and in-out variable tab in local variable tables • Input, output, I/O parameter of functions, or I/O parameter of function blocks on the Ladder Editor • ST Editor • Trace target variable table for data tracing (Note: Variables for functions are excluded.)
	Return value for functions	<ul style="list-style-type: none"> • Return value tab in local variable tables • Input, output, I/O parameter of functions, or I/O parameter of function blocks on the Ladder Editor • ST Editor
	I/O port	I/O Map
	Function	<ul style="list-style-type: none"> • Ladder Editor • ST Editor • Function in the Multiview Explorer
	Function block	<ul style="list-style-type: none"> • Function block instance variable in local variable tables • Ladder Editor • ST Editor • Function block in the Multiview Explorer
	Data type	Data Type Editor

Areas for Cross Reference

The following table shows the areas where the usage locations of referenced element are detected. The areas vary depending on the type of the referenced element you select. The following areas are displayed in the cross reference list if the referenced element is used in the areas.

Referenced element	Areas where usage locations are detected
Variable	<ul style="list-style-type: none"> Input, output, I/O parameter of functions, or I/O parameter of function blocks on the Ladder Editor Text in ST Editor
I/O port	<ul style="list-style-type: none"> I/O Map Global variable table Internal variable tab in local variable tables
Function	<ul style="list-style-type: none"> Ladder Editor ST Editor
Function block	<ul style="list-style-type: none"> Ladder Editor ST Editor
Data type	<ul style="list-style-type: none"> Data Type Editor Global variable table External variable tab, internal variable tab, and in-out variable tab in local variable tables

Cross Reference List Details

The following tables describe the contents of items displayed in the cross reference list. The title of the displayed items differs depending on the type of the referenced element.

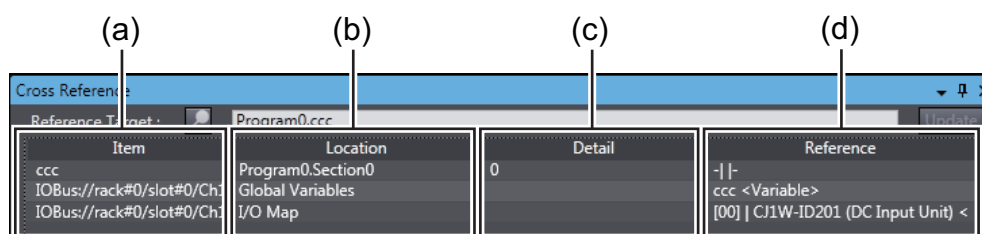

Titles of items

Referenced element	(a)	(b)	(c)	(d)
Variable or I/O port	Item	Location	Detail	Reference
Function	Function	POU	Rung/Line number	Reference
Function block	Function Block	POU	Rung/Line number	Reference
Data type	Data Type	POU/Definition	Not displayed.	Reference

Contents of items

	Description
(a)	The name of the referenced element is displayed.
(b)	Locations where the element is used (POU name, global variable, and I/O Map) are displayed. The data type is displayed if the referenced element is a data type.

	Description
(c)	If the referenced element is used in the Ladder Editor or ST Editor, the rung numbers or line numbers of the usage locations are displayed.
(d)	The specific location where the referenced element is used is displayed.

List Display Example for Data Type Cross References

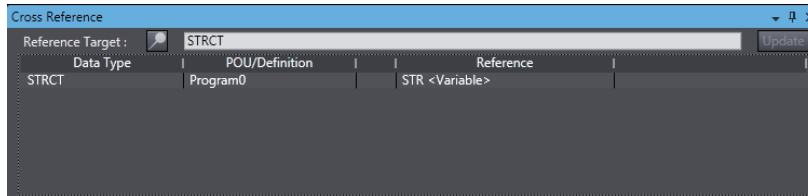

Additional Information

- If the cross references are for a structure variable member, union variable member, or array variable element, the variable that contains the member or element is displayed in the cross reference list in addition to the specified member or element.
- If a cross reference is for an input variable or output variable of a function block instance, the function block instance is also displayed in the cross reference list.
- You can select **Fixed Target Cross Ref.** from the pop-up menu on the Ladder Editor or ST Editor to lock the cross reference items and display the cross reference list.
- If the same variable is used in the Controller and an NA-series PT, after you display the NA-series PT, the usage locations of the NA-series PT are also displayed in the cross reference list for the Controller.

Viewing Usage Locations from the Cross Reference List

You can view where elements are used from the cross reference list.

Select the item you want to find references for from the list. The locations where that item is used appear in the Edit Pane.

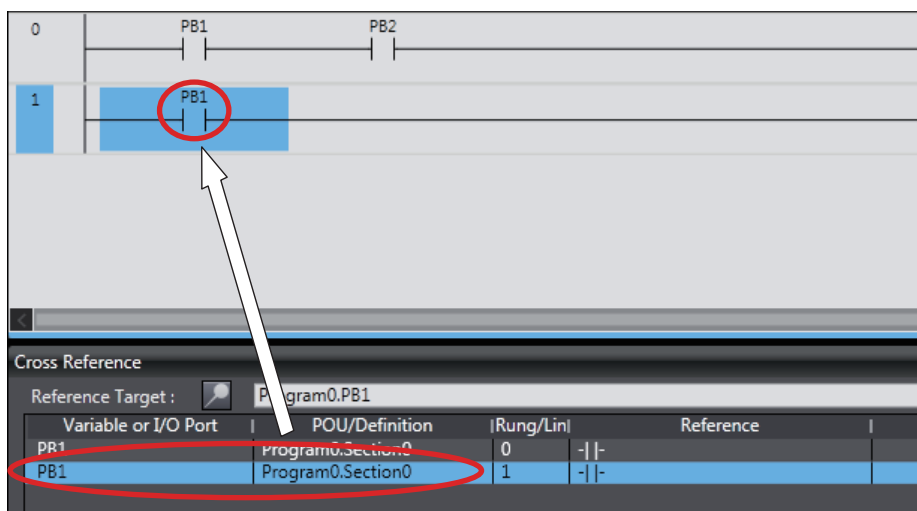

7-2-5 Online Editing

Online Editing

The online editing function is used to add to or change part of a program in the CPU Unit directly from the Sysmac Studio.

You can select any of the following to perform online editing.

- Section and POU (function or function block) written in ladder diagrams
- POU (program, function, or function block) written in ST
- Global variable



Additional Information

You can change the set values of timers and counters during online editing.

WARNING

- Check the user program for proper execution before you use it for actual operation.
- Execute online editing only after you confirm that no adverse effects will be caused to the operation of the master and slave axes if the synchronized control processing time is extended.
- Before you perform online editing for a function or a function block, check the locations where the function or function block is used and confirm the range that will be affected.



What Online Editing Can Do

The following table lists what you can and cannot do with online editing.

Item to edit	You can	You cannot
Section or POU (function or function block) written in ladder diagrams	<ol style="list-style-type: none"> Do the following for all rungs in the selected section or POU: Change the logic, add or change variables, add rungs, or delete rungs. Add or change rung comments. Add local variables (only internal variables (VAR) and external variables (VAR_EXTERNAL)) to the selected section or POU. Change global or local variable attributes for the selected section or POU.*1 Add or delete calls to POUs (functions or function blocks). Add or change element comments. 	<ol style="list-style-type: none"> Delete global or local variables. Add global variables and change global variable attributes.*1 Add local variables (except for internal and external variables) to the selected section or POU.

Item to edit	You can	You cannot
A POU written in ST	a. Change all of the logic in the selected POU. b. Add local variables (only internal variables (VAR) and external variables (VAR_EXTERNAL)) to the selected POU. c. Change local variable attributes in the selected POU.*1 d. Add or delete calls to POUs (functions or function blocks).	a. Delete global or local variables. b. Add global variables and change global variable attributes. c. Add local variables to the selected POU (except for internal and external variables).
Global variables	a. Add variables. b. Change the attributes of the selected variable.*1	a. Delete variables.

*1. Refer to *Variable Attribute Change Supported/Not supported* on page 7-42 for details.

● Variable Attribute Change Supported/Not supported

The following table shows which attribute of local and global variables can be changed or cannot be changed with online editing.

For global variables, whether changing is supported or not depends on the edit target for online editing.

Variable attribute	Description	Online edit changing supported/not supported		
		Local variable	Global variable	
			Edit target: global variable	Edit target: section or POU written in ladder diagram
Name	Changing the variable name	Not supported.	Not supported.	Not supported.
Data Type	Changing to a variable of a different type	Not supported.	Not supported.	Not supported.
	Changing to a different size	Not supported.	Not supported.	Not supported.
AT	Enabling/disabling the AT specification	Not supported.	Not supported.	Not supported.
	Changing the allocated addresses	Not supported.	Not supported.	Not supported.
Initial Value	Changing the initial value	Supported.	Supported.	Not supported.
Retain	Enabling/disabling the retain attribute	Not supported.	Not supported.	Not supported.
Constant	Enabling/disabling the constant attribute	Not supported.	Not supported.	Not supported.
Network Publish	Specifying/not specifying Network Publish	Not supported.	Not supported.	Not supported.

Variable attribute	Description	Online edit changing supported/not supported		
		Local variable	Global variable	
			Edit target: global variable	Edit target: section or POU written in ladder diagram
Edge	Changing the edge detection condition of the input variable	Not supported.	Not supported.	Not supported.
Comment	Changing the comment	Supported.	Supported.	Supported.* ¹

*1. When the *Use global variable comment* check box is selected under *External variable comments* in *Ladder/ST Editors* in the option settings, you can select external variables in the Ladder Editor to change global variable comments.

Starting Online Editing

Go online with the Controller or Simulator and select **Online Edit - Start** from the **Project** Menu. Or, right-click while the object to edit online is displayed and select **Online Edit - Start**.

This allows you to edit programs.

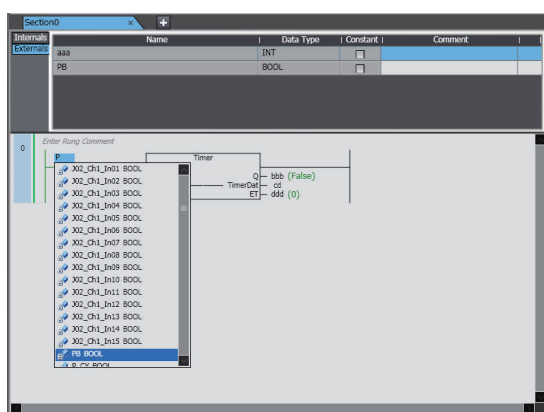

- To perform online editing, the data in the NJ/NX/NY-series Controller you are connected to must be the same as the project data in the Sysmac Studio. If they are not the same, an error occurs and online editing does not start.
- When online editing begins, you can edit the items that are displayed in the Edit Pane.
 - Example: To edit global variables, display the global variable table first and then start online editing.
- If there is no data to edit displayed in the Edit Pane, you can edit the selected item in the Multiview Explorer. When you begin online editing, the selected data is displayed in the Edit Pane.
- You cannot start online editing unless editable data is selected in the Multiview Explorer or displayed in the Edit Pane.
- You cannot change the item to edit during online editing. You must first stop online editing, change the item to edit, then start online editing again.

Transferring Changes Made during Online Editing

Perform online editing, and then select **Online Edit - Transfer** from the **Project** Menu. Or, right-click while the location that you are currently editing online is displayed and select **Online Edit - Transfer**. The results of online editing are transferred to the Controller or Simulator.

- If the item you changed during online editing is modified by any other Support Software (i.e., if Controller data is modified after you start online editing), you cannot transfer the changes made during online editing. If that happens, end the current online editing session and start online editing again.
- You can transfer changes made during online editing even if other items are modified by other Support Software.



Precautions for Correct Use

After you transfer the changes made during online editing, they are applied to the CPU Unit. Do not turn OFF the power supply to the Controller while the changes are being applied. While the changes are being applied, confirmation dialog boxes for the items that are transferred and non-volatile memory backup dialog boxes are displayed. If you turn OFF the power supply to the Controller while the changes are being applied, a major fault level Controller error will occur when the power supply is restored. If an error occurs, download the user program again.

Canceling Online Editing

Perform online editing, and then select **Online Edit - Cancel** from the **Project** Menu. Or, right-click while the location that you are currently editing online is displayed and select **Online Edit - Cancel**. All changes that were made after the online editing was started are canceled and the display before the online editing was started is restored.

Displaying the Current Online Edit Pane

You can jump to the current online Edit Pane.

- 1 Select **Online Edit - Go to Edit Pane** from the **Project** Menu. Or, right-click and select **Online Edit - Go to Edit Pane**.

The section or ST program for which online editing is currently in progress is displayed in the Edit Pane.

Simultaneous Online Editing by More Than One User

More than one user can perform online editing simultaneously under the following restrictions with an NJ/NX/NY-series Controller and the Sysmac Studio.

Operation	Editing condition	Restrictions	Details
Starting online editing	---	None	If the conditions of the above Starting Online Editing are satisfied, each user can start online editing even when one or more users already started online editing.

Operation	Editing condition	Restrictions	Details
Transferring changes made with online editing	Users editing different POU's	None	---
	Users editing the same POU or global variable	Only the user who transfers the changes first can perform the transfer.	Other users must cancel their changes and perform synchronization before they start online editing again.
Canceling online editing	None	None	---

Restrictions in Online Editing

- You cannot delete variables from variable tables during online editing.
- You cannot change the attributes of variables during online editing.

7-2-6 Changing the Operating Mode

● Operating Modes

There are two operating modes for NJ/NX/NY-series Controllers, depending on if control programs are executed or not. These are RUN mode and PROGRAM mode.



Precautions for Safe Use

Always confirm the safety of the system before you change the operating mode of the Controller.

● Procedure for Changing the Operating Mode

Use the following procedure to change the operating mode of the connected Controller.

- 1 Select **Mode - RUN Mode** or **PROGRAM Mode** from the **Controller Menu**.
One of the following confirmation dialog boxes is displayed.

Changing from PROGRAM to RUN Mode

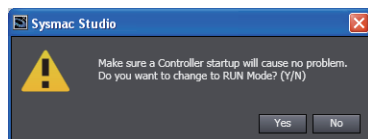

Changing from RUN to PROGRAM Mode

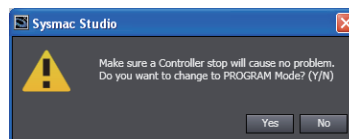

- 2 Confirm that no problem will occur even if you change the operating mode, and then click the **Yes Button**.
 - When you change the operating mode, the values of all I/O devices except for those for variables with a Retain attribute are cleared.
 - I/O devices are refreshed even in PROGRAM mode.

Check for any external influences on I/O device operations before you change the operating mode.

7-2-7 Monitoring Controller Status

Controller Status Monitor

● Controller Status Monitor

You can monitor the connected Controller and displays the results in the Controller Status Pane. You can view the Controller Status Pane only when online with the Controller or connected to the Simulator.

● Displaying the Controller Status Pane

The Controller Status Pane is displayed in the same area as the Toolbox when online with the Controller or connected to the Simulator.



Online with the Controller

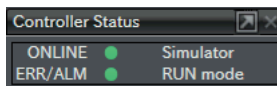

Connected to the Simulator



● Controller Status Pane Extended Operations

Use the buttons ( ) in the title bar of the Controller Status Pane to switch between the basic and detailed views.

Detailed View When Connected to a Controller

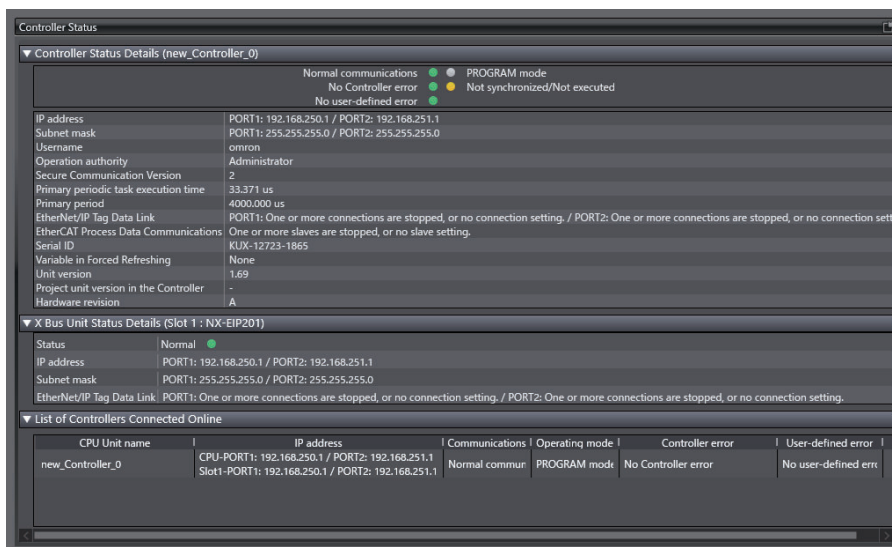

Detailed View When Connected to the Simulator

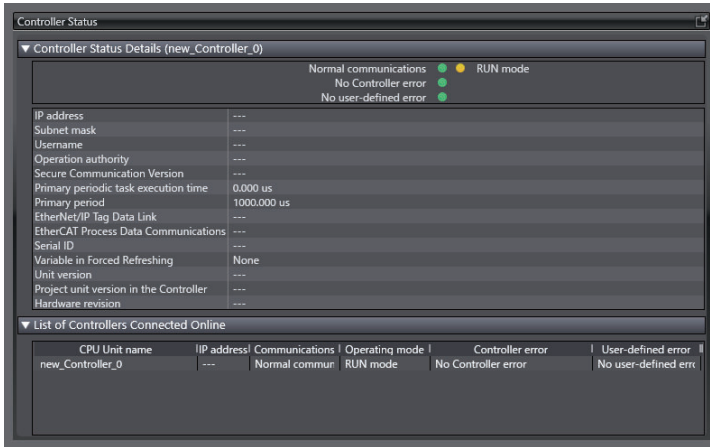

● **Controller Status Information**
Detailed View

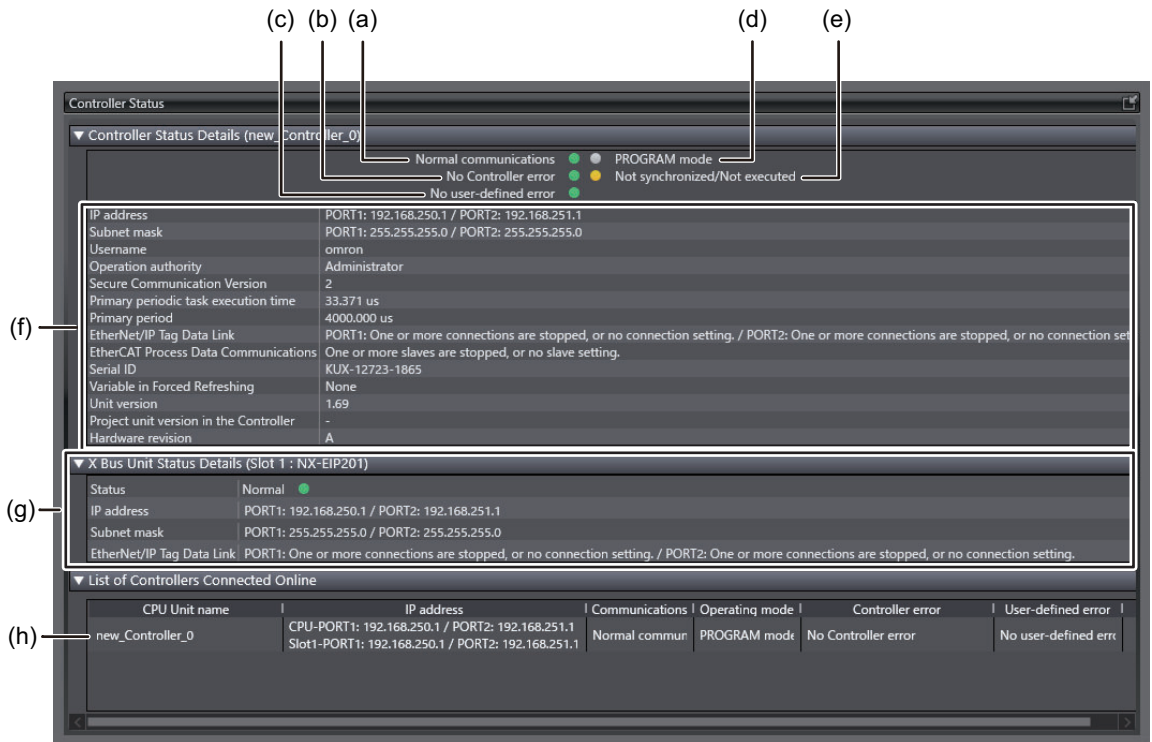

Basic View

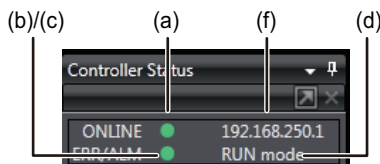

	Display item	Displayed information and indicator colors	Remarks
(a)	Communications state	<ul style="list-style-type: none"> Normal communications: Green Communications error: Flashing red 	On the Basic View, only the color of the indicator is displayed.

	Display item	Displayed information and indicator colors	Remarks
(b)	Errors, Controller error	<ul style="list-style-type: none"> No Controller error: Green Partial or minor fault level Controller error: Yellow Major fault level Controller error: Red NX502 Controller: This is displayed in red if there is an error in either the CPU Unit or X Bus Units.	On the Basic View, only the color of the indicator is displayed.
(c)	Errors, User-defined error*1	<ul style="list-style-type: none"> No user-defined error: Green User-defined error: Red NX502 Controller: This is displayed in red if there is an error in either the CPU Unit or X Bus Units.	On the Basic View, only the color of the indicator is displayed.
(d)	Controller operating mode*1	<ul style="list-style-type: none"> RUN mode: Yellow PROGRAM mode: Not lit 	On the Basic View, only the mode is displayed.
(e)	Synchronization status	<ul style="list-style-type: none"> Synchronized: Green Not synchronized/Not executed: Yellow 	Nothing is displayed for the Simulator.
(f)	IP address	IP address <ul style="list-style-type: none"> NX701, NX502, or NX102 Controller, or NX-CSG Communication Control Unit: <ol style="list-style-type: none"> IP address of Port 1 IP address of Port 2 NY-series Controller: <ol style="list-style-type: none"> IP address of Port 1 IP address of Internal Port 1 	If the Controller has two EtherNet/IP ports, both addresses are displayed. For the Simulator, <i>Simulator</i> is displayed on the Basic View and --- is displayed on the Detailed View.
	Subnet mask	Subnet mask <ul style="list-style-type: none"> NX701, NX502, or NX102 Controller, or NX-CSG Communication Control Unit: <ol style="list-style-type: none"> Subnet mask of Port 1 Subnet mask of Port 2 NY-series Controller: <ol style="list-style-type: none"> Subnet mask of Port 1 Subnet mask of Internal Port 1 	If the Controller has two EtherNet/IP ports, both subnet masks are displayed. --- is displayed for the Simulator.
	Username	User name that is currently connected online	--- is displayed when the user authentication function of the Controller is disabled.
	Operation authority	Administrator, Designer, Maintainer, Operator, Observer, or unused	--- is displayed for the Simulator.
	Secure Communication Version	Secure Communication Version	--- is displayed if the Controller does not support the Secure Communication Version. --- is displayed for the Simulator.
	Primary periodic task execution time*1	Execution time (μs)	---

	Display item	Displayed information and indicator colors	Remarks
	Primary period* ¹	Period time (μs)	---
	EtherNet/IP Tag Data Link	<ul style="list-style-type: none"> Communicating One or more connections are stopped, or no connection setting. 	--- is displayed for the Simulator.
	EtherCAT Process Data Communications* ¹	<ul style="list-style-type: none"> Communicating One or more slaves are stopped, or no slave setting. 	--- is displayed for the Simulator.
	Serial ID	Serial ID	--- is displayed for the Simulator.
	Variable in Forced Refreshing	Yes/None	---
	Unit version	Unit version of CPU Unit	--- is displayed for the Simulator.
	Project unit version in the Controller	The unit version set in the Sysmac Studio project stored in the CPU Unit	--- is displayed for the Simulator.
	Hardware revision	The hardware revision of the CPU Unit	- is displayed if the hardware revision is in blank. --- is displayed for the Simulator.
(g)* ²	Status	<ul style="list-style-type: none"> No error: Green Error: Red 	Nothing is displayed for the Simulator.
	IP address	<ul style="list-style-type: none"> IP address of EtherNet/IP Port 1 on X Bus Unit IP address of EtherNet/IP Port 2 on X Bus Unit 	Nothing is displayed for the Simulator.
	Subnet mask	<ul style="list-style-type: none"> Subnet mask of EtherNet/IP Port 1 on X Bus Unit Subnet mask of EtherNet/IP Port 2 on X Bus Unit 	Nothing is displayed for the Simulator.
	EtherNet/IP Tag Data Link	<ul style="list-style-type: none"> Communicating One or more connections are stopped, or no connection setting. 	Nothing is displayed for the Simulator.
(h)	List of Controllers Connected Online	CPU Unit name, Controller IP address, Communications, Operating mode* ¹ , Controller error, and User-defined error* ¹	The Controller status is displayed for all online Controllers. The items are the same as those in the Controller Status Details and X Bus Unit Status Details .

*1. This is not displayed when an NX-CSG Communication Control Unit is connected.

*2. This is displayed only when X Bus Units are mounted on an NX502 CPU Unit.

7-2-8 Task Execution Status Monitor

● Task Execution Status Monitor

You can monitor the execution status of the tasks that execute programs on an NJ/NX/NY-series Controller or in the Simulator.

● Displaying the Task Execution Status Monitor

- 1 Double-click **Task Settings** under **Configurations and Setup** in the Multiview Explorer.
- 2 Click the Task Execution Status Monitor Button (🔍) in the Edit Pane.
The names of all tasks/programs that are currently in execution and their execution status are displayed.

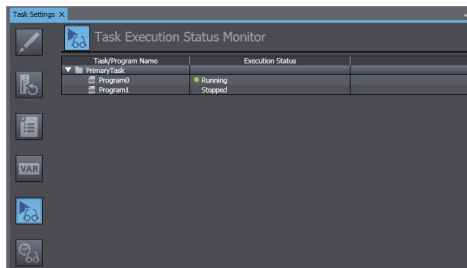

7-2-9 Task Execution Time Monitor

● Task Execution Time Monitor

You can monitor the execution time of each task when the user program is executed on an NJ/NX/NY-series Controller or in the Simulator. When the Simulator is connected, you can also monitor the real processing time of tasks.*1

This allows you to perform a Controller performance test.

*1. For an NY-series Controller, you cannot monitor the task execution time when the Simulator is connected.

● Contents of the Task Execution Time Monitor

Connected to the Controller

Go online with the Controller and then perform the following procedure.

- 1 Double-click **Task Settings** under **Configurations and Setup** in the Multiview Explorer.
- 2 Click the Task Execution Time Monitor Button (📊) in the Edit Pane.

You can view the following information for all executing tasks: minimum values, average values, maximum values, set periods, exceeded periods, task execution times, and task period exceeded counts.*1

With an NJ-series Controller, you can also monitor the task execution time ratio for the entire Controller.

*1. The task period exceeded count is the number of times that the task execution time exceeded the task period. This is not the same as the number of times a Task Period Exceeded Error occurred.

For details on the settings, refer to the *NJ/NX-series CPU Unit Software User's Manual (Cat. No. W501)* or *NY-series Industrial Panel PC / Industrial Box PC Software User's Manual (Cat. No. W558)*.

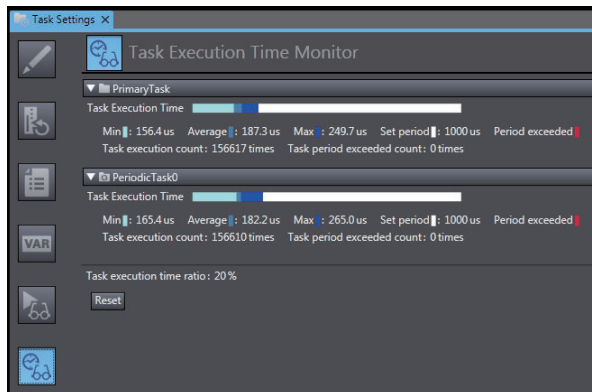

Connected to the Simulator

When connected to the Simulator, the time required from the beginning of task execution until it ends is estimated through a simulation.

- You can display the estimated average execution time, maximum task execution time, and CPU usage*¹ for both the execution of periodic tasks and system services*¹ that are executed from when task execution is started until it is completed.
- You can use the estimated times as a guide in determining task periods.
- You can run the Simulator in Execution Time Estimation Mode.

*1. This is displayed only for an NJ-series Controller.

Refer to *Estimating Task Execution Times* on page 7-92 for details.



Precautions for Correct Use

- The estimated times are not necessarily the same as the actual task execution times on the physical Controller. Depending on the user program and I/O configuration, the execution times on the physical control may exceed the estimated maximum value. Use the estimated times as a guide in determining task periods.
- If you use tag data links, the execution times on the physical control may exceed the estimated values.

7-2-10 Axis Status Monitor (MC Monitor Table)

Axis Status Monitor

The Axis Status Monitor is used to monitor the error status, input signal status, command values, and current values.

Note To monitor axis status, the axis must be registered and transferred to the Controller.

- 1** Go online.
- 2** Right-click **Axis Settings** under **Configurations and Setup - Motion Control Setup** on the Multiview Explorer and select **MC Monitor Table** from the menu.
The Axis Status Monitor is displayed.

Axis Name	1 MC_Axis000(0)	2 MC_Axis001(1)	3 MC_Axis002(2)	4 MC_Axis003(3)
▼ Cfg				
AxisNo	0	1	2	3
Actuable	Used axis	Used axis	Used axis	Used axis
AxisType	Servo axis	Servo axis	Virtual servo axis	Virtual servo axis
NodeAddress	9	10		
▼ Status				
Ready	0	0	1	1
Disabled	1	1	0	0
StandStill	0	0	1	1
Decresta	0	0	0	0
Continuous	0	0	0	0
Synchronized	0	0	0	0
Homing	0	0	0	0
Stopping	0	0	0	0
ErrorStop	0	0	0	0
Coordinated	0	0	0	0
▼ Details				
Idle	1	1	1	1
InPosWaiting	0	0	0	0
Homed	0	0	0	0
InHome	0	0	0	0
VelLimit	0	0	0	0
▼ Dir				
Pos	1	1	1	1
Neq	0	0	0	0
▼ DrvStatus				
ServoOn	0	0		
Ready	0	0		
MainPower	0			
P_OT	0			
N_OT	0			
HomeSw	0			
Home	0			
ErrdStop	0			
Latch1	0			
Latch2	0			
DrvAlarm	0			
DrvWarning	0			
ILA	0			
CSP	0			

● Changing the Axis

Use the following procedure to change the axis to monitor.

- 1 Open the Axis Status Monitor.
- 2 Right-click anywhere in the pane and select **Select the Axes to Show** from the menu. The following dialog box is displayed.

NX701 Controllers

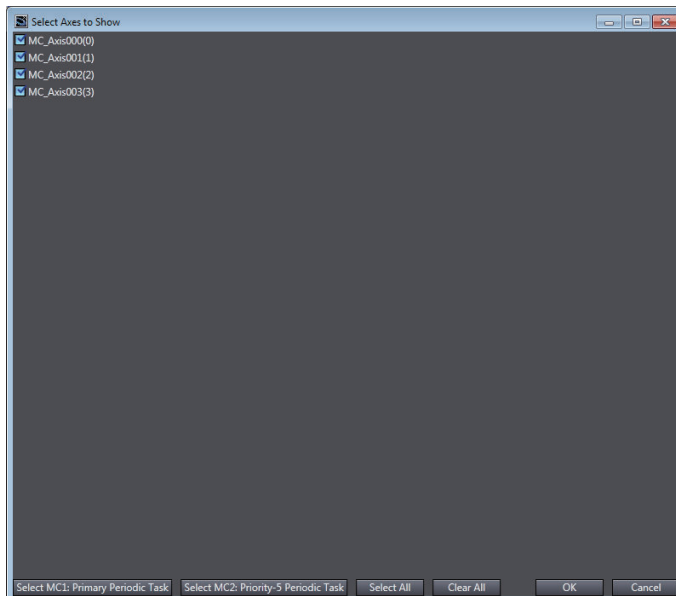

NJ/NY-series Controllers and NX502, NX102, or NX1P2 Controllers

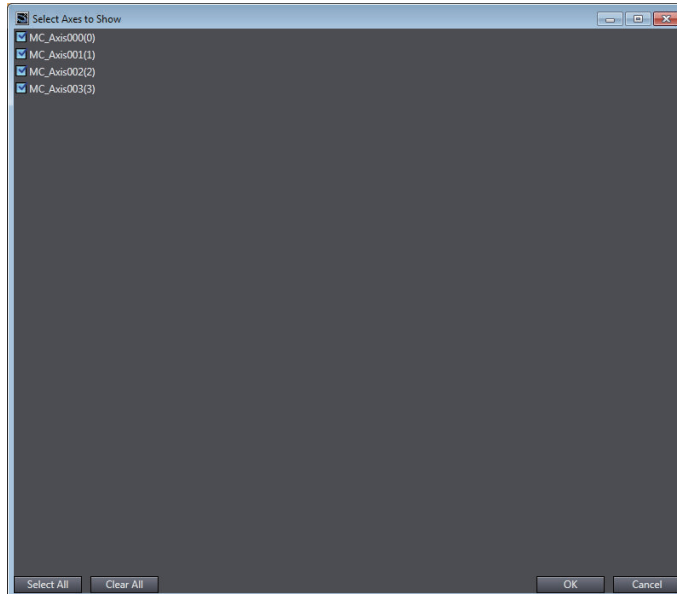

Button	Description	Remarks
Select MC1: Primary Periodic Task	Selects only the axes for which motion control processing is executed in the <i>primary periodic task (MC1)</i> .	This is displayed only for an NX701 Controller.
Select MC2: Priority-5 Periodic Task	Selects only the axes for which motion control processing is executed in the <i>priority-5 periodic task (MC2)</i> .	This is displayed only for an NX701 Controller.
Select All	Selects all of the axes.	
Clear All	Clears the selections of all of the axes.	

- 3 Select the axis you want to display in the Axis Status Monitor, and then click the **OK** Button. Only the selected axes are displayed in the Axis Status Monitor.

7-2-11 Data Tracing

Data Tracing

● Data Tracing

You can use data tracing to sample variables without any additional programming.

You can choose between two trace methods: a triggered trace, where you set a trigger condition and data is saved before and after that condition is met, or a continuous trace, in which continuous sampling is performed without any trigger and the results are stored in a file on your computer. However, you can still display data retrieved on the Sysmac Studio and save those results to a file even if you use a triggered trace.

These same functions can be used with the Simulator as well.

● Executing a Data Trace

- 1 Right-click **Data Trace Settings** under **Configurations and Setup** in the Multiview Explorer and select **Add - Data Trace** from the menu.

DataTrace0 is added to the Multiview Explorer.

- 2 Double-click DataTrace0 or right-click DataTrace0 and select **Edit** from the menu. The Data Trace Tab Page is displayed.

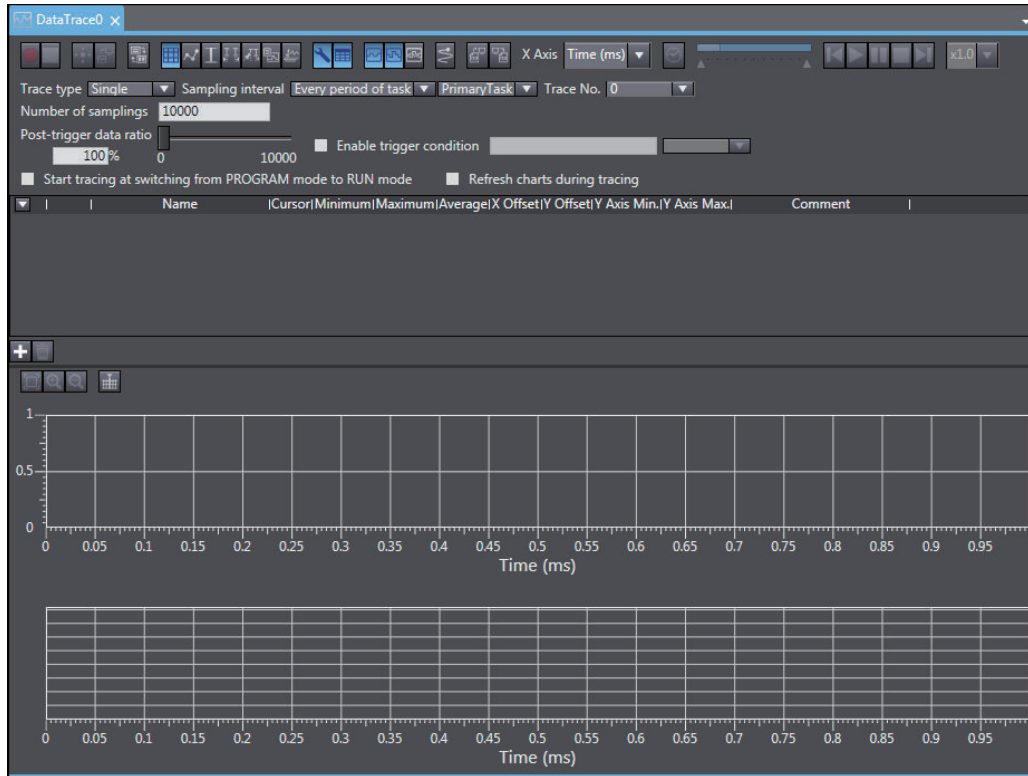

Additional Information

If there are previous trace results, a confirmation dialog box is displayed to ask whether to load the previous trace results when the Data Trace Tab Page is displayed. When you click the **No** Button, the previous trace results are not loaded and the Data Trace Tab Page is displayed faster than when the **Yes** Button is clicked. To display the trace results after displaying the Data Trace Tab Page without loading the previous trace results, close the Data Trace Tab Page, open it again, and click the **Yes** Button to confirm loading the previous results.

● Trace Type Setting

Select from the following two different trace types.

- Single Trace

Set a trigger condition to start sampling. Data from before and after the condition is met is saved. Sampling stops automatically when the specified number of samples is reached. The setting range of the number of samples is 100 to 10,000 per variable.
- Continuous Trace

Sampling starts without any trigger and continues on even after 10,000 data points are collected. Sample data is transferred to a computer as it is collected and saved to a file.

Procedure

- 1 Click the Trace type Box and select either *Single* or *Continuous*.

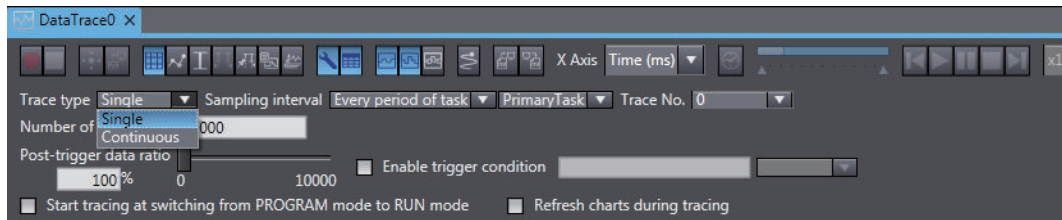

Precautions for Correct Use

Some data may not be sampled when using a continuous trace depending on your sampling interval and communications status.

● Setting Sampling Intervals

You can set the interval to perform sampling on the target data. You can set the sampling interval with any of the three methods described below.

- Every Period of Task
Specify a task. The period of that task is set as the sampling period.
- Time
The time you enter is set as the sampling period. However, the time you enter is rounded off to an integer multiple of the primary periodic task.
- Use Sampling Instruction
With this method, sampling is performed whenever the TraceSamp instruction is executed in the user program.

Procedure

- 1 Click the sampling interval selection box and select *Every period of task*, *Time*, or *Use sampling instruction*.

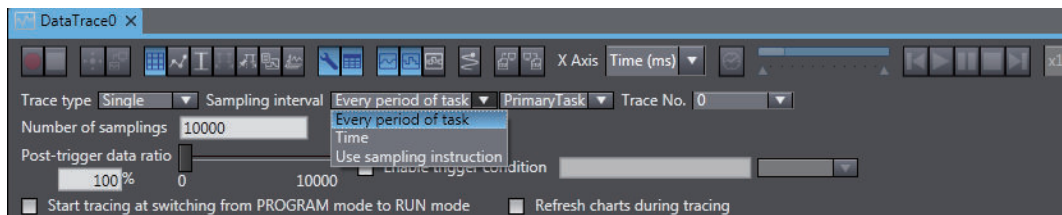

- 2 If you select *Every period of task*, select the task you want to use as the sampling period in the task box.
If you chose *Time*, enter a time in the Time field. The time you entered is automatically rounded off to the nearest integer multiple of the period of the primary period task. (The maximum value is 65,535 times the task period of the primary periodic task.)

● Setting Number of Samplings

When you select *Single* for the trace type, set the number of samplings per variable to 100 to 10,000.

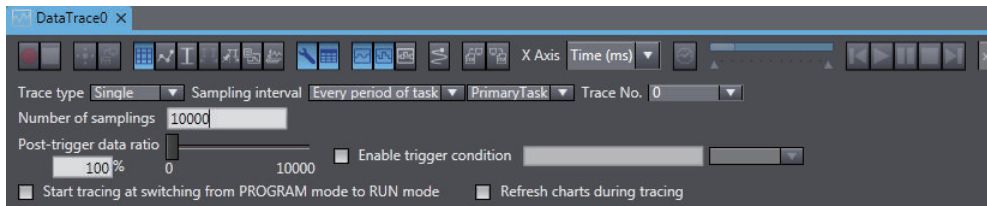

● Setting Triggers

• Setting Triggers

To perform a triggered trace, you set a condition to trigger sampling. A suitable trigger condition is set to record data before and after an event.

Procedure

- 1 Select *Single* for the trace type.
A dialog box to set the trigger is displayed.

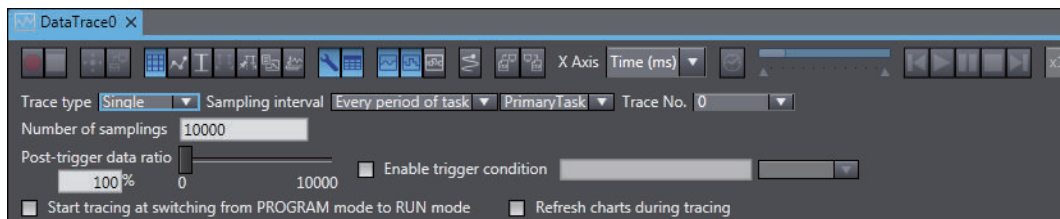

- 2 Select the Enable trigger condition Check Box.
- 3 Enter the variable name to use as a trigger.
- 4 Set a condition for the variable. (Example: X1>100, x2<16#FF)
- 5 Set the Post-trigger data ratio Slider to the position of the trigger within the sampled data.
If the ratio is set to 100%, all data is sampled after the trigger condition is met. If the ratio is set to 0%, all data is sampled before the trigger condition is met.



Additional Information

- The trigger changes to TRUE when the Trigger ON Button (ON) is clicked or when the Data Trace Trigger (TraceTrig) instruction is executed.
- You can also drag variables from the Variable Manager to the trigger condition area to register them.

● Setting a Continuous Trace

The method to save the data traced during a continuous trace is set.

Procedure

- Continuous Trace Settings Dialog Box

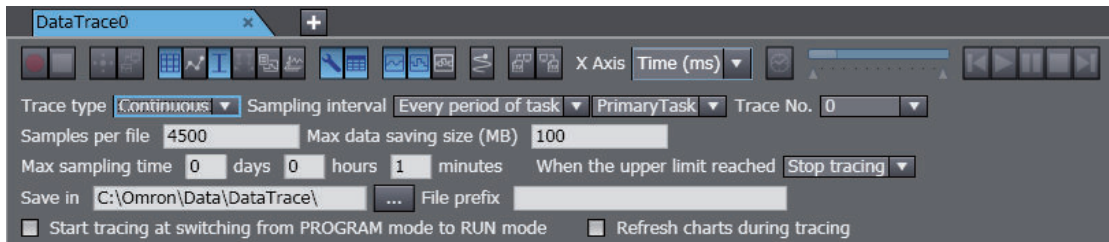

- 1 Set the number of samples to save in each file.
- 2 Set the maximum size to save in a file.
- 3 Set the maximum time period to save data for.
- 4 Select from the following two actions to take when the size or time limit is reached.
 - Stop tracing: Stops sampling.
 - Delete old files: Continues sampling but deletes the oldest saved data to make room.
- 5 Select the folder where you want to save the file.
- 6 Enter the prefix for the file name.
The filename is output as follows: "prefix" "start_time" "5-digit_serial_number".csv (with no spaces).

● Setting Variables to Sample

You must set the variable to trace. For information on the variables that you can set, refer to the *NJ/NX-series CPU Unit Software User's Manual (Cat. No. W501)* or *NY-series Industrial Panel PC / Industrial Box PC Software User's Manual (Cat. No. W558)*.

Procedure

- Trace Target Variable Table

	Name	(Cursor)	(Minimum)	(Maximum)	(Average)	X Offset	Y Offset	Y Axis	Min. Y Axis	Max. Y Axis	Comment
<input checked="" type="checkbox"/>	E004_CH1_Input_16bit					0	0	0	0		
<input checked="" type="checkbox"/>						0	0	0	0		

● Adding Variables for Tracing

- 1 Click the **Add Target Button** (+).
A trace variable line is added to the list.
- 2 Enter the variable name. Start typing in the field to see a list of variable candidates. Select the variable you want to trace from this list.



Additional Information

- You can also drag variables to the registration area from a variable table, from the Variable Manager, or from the trace target variable table of other data trace settings to register them.
 - Drag the sampled variables to change the order in which they are displayed. Press the Shift Key or Ctrl Key to drag more than one variable at the same time.
 - You can display sampled variables in ascending or descending order of the following items.
 - a) Check box
 - b) Analog/digital
 - c) Variable name
- Click the title of the corresponding column to change the order.

● Deleting a Variable for Tracing

- 1 Select the line of the variable you want to delete.
- 2 Click the **Remove Target** Button or press the Delete Key.

● Starting and Stopping Tracing

You transfer the data trace settings to the Controller to start tracing. If you selected *Single* as the trace type, tracing waits for the trigger to begin sampling. If you selected *Continuous*, sampling begins immediately and all traced data is transferred to the computer as it is gathered and saved to a file.

Procedures

● Starting a Trace

- 1 Go online with the Controller.
- 2 Click the **Execute** Button.



If displaying a graph during tracing is enabled, the graph is drawn as soon as sampling starts.

● Stopping a Trace

- 1 Click the **Stop** Button.

Traces also stop automatically in the following cases.

 - When the trace type is *Single* and the number of samples reaches the specified number of samples
 - When the trace type is *Continuous*, the maximum size or time period is reached, and the action to take when a limit has been reached is set to *Stop Tracing*





Additional Information

- If you select the *Start tracing at switching from PROGRAM mode to RUN mode* Check Box in the Data Trace Tab Page, data tracing begins automatically the next time the Controller enters RUN mode.
- You can perform more than one data trace at the same time. (The number of data traces depends on the model of the CPU Unit.) You can change the *trace number* in the Data Trace Setup Dialog Box to perform data tracing with different settings even if another trace is being performed with a different number. With continuous tracing, you can run only one trace at the same time. You cannot perform traces for other trace numbers from the same computer during a continuous trace. (You can perform other traces from another computer.)
- If you attempt to start more than one data trace with the same trace number on the same Controller, the data trace does not start even if you click the button.
- You can click the **Upload Trace Data** Button () while the data trace is stopped if there is sampled data on the Controller to upload the data trace settings (except for a continuous trace) and data for the specified trace number. The graph for this data is displayed.
- Remain online during a continuous trace until you stop the trace. If you do go offline during a continuous trace, go online and stop the current trace, and then start the continuous trace again.

● Displaying Trace Results

You view the results of the traced data in either a chart or in 3D Motion Monitor. Refer to *3D Motion Monitor Display Mode* on page 7-67 for information on the 3D Motion Monitor Display Mode.

After sampling begins, sample data is immediately transferred and drawn on the graph.

The trace target variable table shows the maximum, minimum, and average values for each variable.

● Switching Graphs





You can toggle between the three different types of graphs: a digital chart for BOOL data, an analog chart for all other types of data, and a 3D Motion Monitor Display Mode for viewing the operation of motion axes. You can also view the digital and analog charts overlaid on top of each other.

Procedure

Click the required button.



The buttons are described in the following table.

Button	Description
	Displays and hides a digital chart for BOOL data.
	Displays and hides an analog chart for non-BOOL data.
	Displays and hides the overlaid display of the digital and analog charts.
	Displays and hides a 3D motion monitor results for the operation check of motion control axes.

● Selecting the Display Target

You can show or hide trace target variable graphs.

Select or clear the check box for a trace target variable. Then, the graph appears or disappears accordingly.

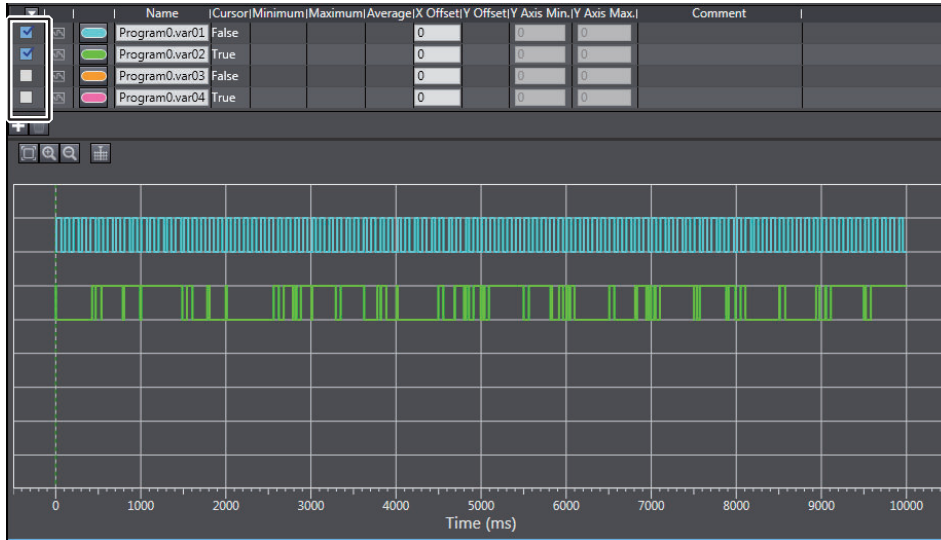

To select or clear the check boxes for all trace target variables at the same time, click the button in the title row, and select **Select all** or **Clear all**.



Additional Information

You can also select the display target in the dialog box that is displayed when you select **Settings** from the menu button in the title row.

● Changing the X Axis

Used the following procedure to change the X axis of the digital and analog charts. You can also specify a trace target variable.

Procedure

- 1 Select the data you want to use for the X axis in the X Axis Box.



The digital or analog chart is redrawn using the specified data as the X axis.

● Changing the Y Axis Display Mode

You can select whether to use a different Y axis for each variable or a common Y axis for all variables.

Procedure

- 1 Click the Independent Y Axis Mode Button.
- 2 Select the variable to display as the Y axis in the table.

- 3** You can change the display range for the Y axis for each variable. However, you cannot set the Y offset.

		Name	Cursor	Minimum	Maximum	Average	X Offset	Y Offset	Y Axis Min.	Y Axis Max.	Comment
<input checked="" type="checkbox"/>		E004_CH1_Input_16bit					0		0	0	
<input checked="" type="checkbox"/>		E004_CH2_Input_16bit					0		0	0	

● Zoom In and Zoom Out

You can zoom in and zoom out to view digital and analog charts. Digital charts can only be zoomed in and out along the X axis.

Procedure

- 1** You can click the **Zoom In** () or **Zoom Out** () Buttons instead.

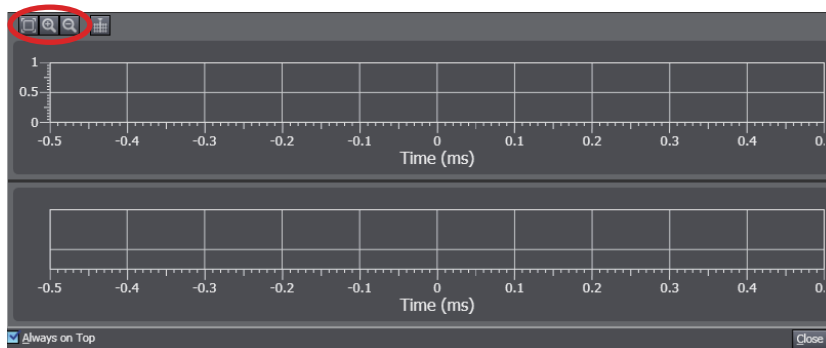

- This changes the scale of each axis. Zooming in and out along the X axis is reflected in both the digital and analog charts.
- Click the **Fit to Display** Button () to automatically scale the graph so that it completely fits on the display.



Additional Information

You can also use the following methods to zoom in and out of the graph.

- Move your mouse over the axis you want to zoom in or zoom out, then scroll your mouse wheel up or down to zoom in or out for that axis.
- Move your mouse over the graph and scroll your mouse wheel up or down to zoom in or out both the X and Y axes centered on the position of the cursor.
- Hold down the Ctrl Key and drag the mouse to select a range to enlarge it.

● Moving Chart Display Area

This allows you to move the display area of the digital and analog charts.

Procedure

- 1** Click anywhere inside the chart. The mouse cursor changes into a move cursor.
- 2** Drag up, down, left, or right to move the display area.
Movement along the X axis is reflected in both the digital and analog charts.

● Specifying a Data Offset

You can shift data on the graph along the X and Y axes. Offsets can be applied only along the X axis for digital charts.

This is a useful feature to use when you want to compare trends between data sets with different starting points.

Procedure

- 1 Enter values for the X offset and Y offset settings in the trace target variable table.

	Name	Cursor	Minimum	Maximum	Average	X Offset	Y Offset	Y Axis Min.	Y Axis Max.	Comment
<input checked="" type="checkbox"/>	E004_CH1_Input_16bit					0	0		0	
<input checked="" type="checkbox"/>	E004_CH2_Input_16bit					0	0		0	

The graph is updated to reflect the changes.

● Cursor Display

A cursor is displayed to show the values of all variables at the specified X axis value.

Procedure

- 1 Click the **Cursor** Button to show or hide this cursor.



- 2 Select the variable for which to check the value in the table.

- 3 Drag the cursor to the left or right to display the values for different positions along the X axis.

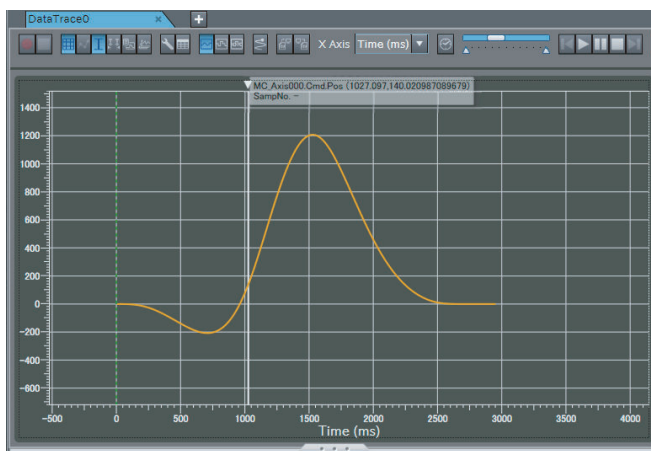

The values for the variable at the cursor position are displayed.

● Moving the Cursor

You can move the cursor by dragging it on the chart or by using the playback controller.



(1) (6) (2) (3) (4) (5)

Button	Function
(1) Time Slider	You can drag the slider to move the cursor. The left edge is the start of the trace data and the right edge is the end.
(2) Playback	The cursor moves automatically at the speed that is specified in the Speed Box.
(3) Pause	The cursor stops where it is.
(4) Stop	The cursor returns to the start.
(5) Frame Forward	Moves the cursor to the next sampled point. Continue to click the button to continuously forward the frame.
(6) Frame Reverse	Moves the cursor to the previous sampled point. Continue to click the button to continuously reverse the frame.

● **Displaying the Range Cursors**

The range cursors show the difference between the two specified points. This is useful for displaying such information as the time between when a certain value changed to TRUE until it changed to TRUE again.

Procedure

- 1 Click the **Show Range Cursors** Button to show or hide this cursor.



- 2 Select the variable for which to check the value in the table.
- 3 Drag the two cursors to the left or right to display the difference in values in the range between the two cursors.
The distance between the two cursors (dx, dy) is shown on the graph.

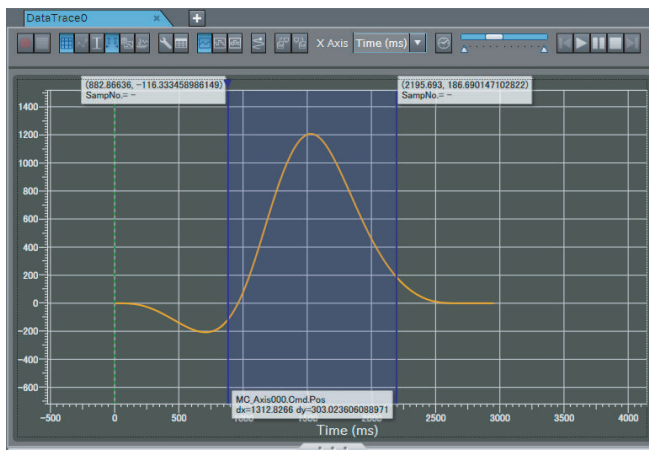

● Displaying the Trigger Location

You can display a Trigger Location Line (a green wave line) to indicate where the trigger changed to TRUE.

This information is displayed automatically. You do not have to enter it.

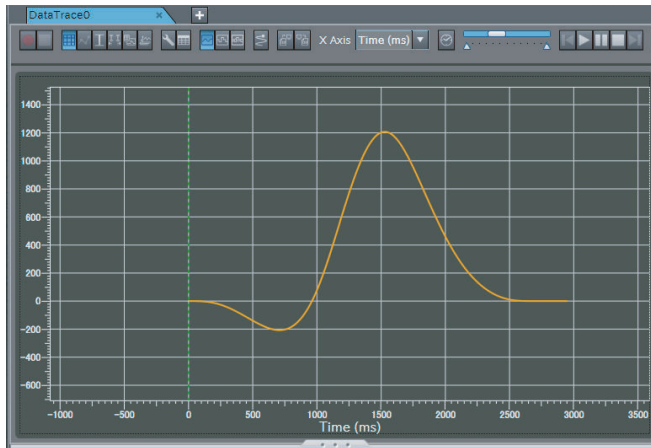

● Displaying a Digital Data Legend

You can display a digital data legend.



Procedure

- 1 Click the Show Legends Button.
The legends (variable names) are displayed on the left side of the digital chart.

● Changing the Graph Colors

You can change the colors of the lines on the graph.

Click the color button for each graph color on the trace target variable table and then change the colors on the Edit Colors Dialog Box.

	Name	Cursor	Minimum	Maximum	Average	X Offset	Y Offset
	E004_CH1_Input_16bit					0	0
	E004_CH2_Input_16bit					0	0
	E004_CH3_Input_16bit					0	0

● Changing the Display Position of the Trace Target Variable Table

You can change the display position of the trace target variable table to above or to the left of the graphs.

Operation Procedure

- 1 Click the **Switch layout** Button on the Data Trace Settings Tab Page.



The display position of the table changes each time you click the button.



● Exporting Trace Results

Trace results are saved within your project automatically when you save the project on the Sysmac Studio.

If you want to save this data as a separate file, you can export the data to a CSV file.

Procedure

- 1 Click the **Export** Button.



A Save File Dialog Box is displayed.

- 2 Specify the file name and where you want to save the file.

Precautions for Correct Use

- If you change any data trace settings after data tracing is completed and the graph is displayed and then export your data, the data exported will use different settings from when those results were created. Do not change any settings before exporting the data.
- The exported CSV file of trace results is encoded in UTF-8 character codes.

Additional Information

- The trace number and the specified number of samples are not exported.
- The 3D equipment models are not exported.

● Importing Trace Results

If you want to import trace results or settings that you have exported, you can import a CSV file that contains trace results data.

Procedure

- 1 Click the **Import** Button.



A Select File Dialog Box is displayed.

- 2 Select the CSV file you want to import.



Precautions for Correct Use

When you import a CSV file, import a file that was exported with the procedure described in *Changing the Display Position of the Trace Target Variable Table* on page 7-64, above. If you edit an exported CSV file, you may not be able to import it.



Additional Information

- If you import trace results when sampled variables are already registered or existing trace results are displayed, the sampled variables and the graphs are imported and added while other settings are not imported. Do not allow the total number of registered sampled variables and sampled variables of imported trace results to exceed the maximum numbers that can be registered. You cannot import data if the total number exceeds the limit.
- If you want to add data from a file to the trace results but the time axes are not the same, enter an X axis offset to adjust the data accordingly.

Visible	Name	X Offset	Y Offset
<input checked="" type="checkbox"/>	MC_Axis000	0	0
<input checked="" type="checkbox"/>	MC_Axis001	0	0

● Importing Continuous Trace Data

You can consecutively import continuous trace results from more than one file. You can select the trace range to display from the box to change the data that is displayed.

- 1 Click the **Import** Button, select one of the CSV files of continuous trace data, and import it. The data from the selected file is displayed and the selected range is displayed in the *Continuous Trace Range Selection Box*.

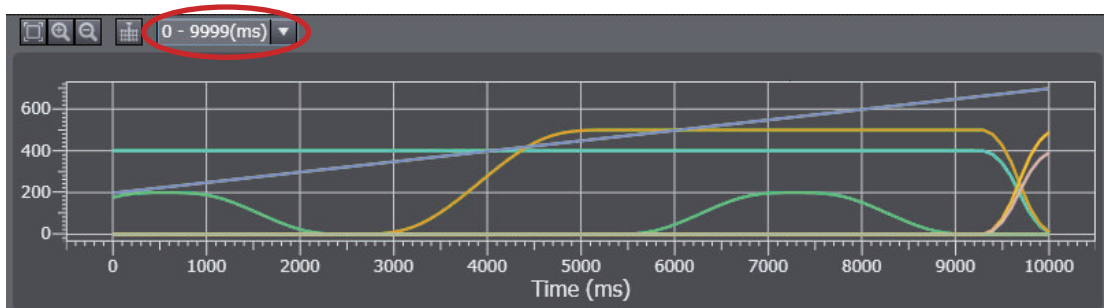

- 2 Select the trace range for which to display the results from the list for the box.

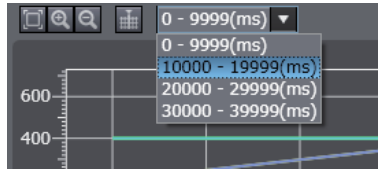

The corresponding CSV file for the trace range is read and the graph is displayed.



Precautions for Correct Use

- You cannot use the above procedure for CSV files that do not contain continuous trace data.
- Place all of the CSV files that contain the separated continuous trace data in the same folder. Do not change the names of the CSV files that were created. If you do, they cannot be read with the above procedure.



Additional Information

The last trace range is displayed in the Continuous Trace Range Selection Box immediately after the continuous trace is completed.

● Printing Trace Results

You can print out data trace settings along with digital and analog charts.

Procedure

- 1 Select **Print** from the **File** Menu.

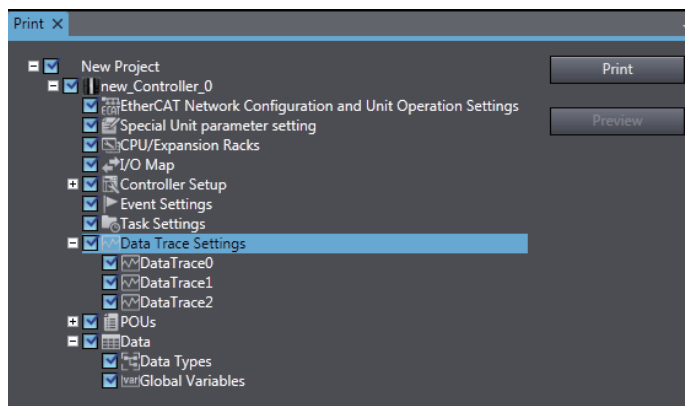

- 2 Expand *Data Trace Settings* in the tree in the Print Tab Page and select the check box beside the trace data you want to print.

- 3 Click the **Print** Button.

3D Motion Monitor Display Mode

You set the axis variables for each element of the 3D equipment model, and then set the 3D equipment into motion according to those axis motions. Refer to *Creating 3D Equipment Models* on page 7-74 for the procedure to create 3D equipment models.

- This motion is linked to the data trace time chart graph.

- You can also display the path of a marker on the 3D equipment at the same time.
- You can also display a two-dimensional path marker for each projection of the 3D display.



Precautions for Correct Use

This function is not supported by the Sysmac Studio (64 bit). The Display 3D Motion Monitor Button is not displayed.



Additional Information

Sysmac Studio (64 bit) version 1.40 or higher support *3D Simulation* which enables to check operations or motions of 3D equipment models and parts in 3D Visualizer. Refer to the *Sysmac Studio 3D Simulation Function Operation Manual (Cat. No. W618)* for details and the conditions of use on 3D Simulation.

● Procedure for 3D Motion Monitor Display Mode

Procedure

- 1** Add an axis to the Multiview Explorer and then set the parameters of the axis variable.
Refer to *5-7 Motion Control Setup* on page 5-80 for the setting procedure.
- 2** Create a program to operate the equipment.
Refer to *Section 4 Programming* on page 4-1 for the programming procedures.
- 3** Create the 3D equipment model with a data trace.
- 4** Register the trigger setting and variables to trace for the data trace.
Refer to *7-2-11 Data Tracing* on page 7-53 for the operating procedures for data tracing.
- 5** Go online with the Controller, change the operating mode to RUN mode, and execute the user program.
- 6** Start tracing the data with the data trace to sample the data.
- 7** Check the trace results on the Data Trace Tab Page.
- 8** Click the Play Button in the Data Trace Tab Page.
The various items move synchronously on the display.

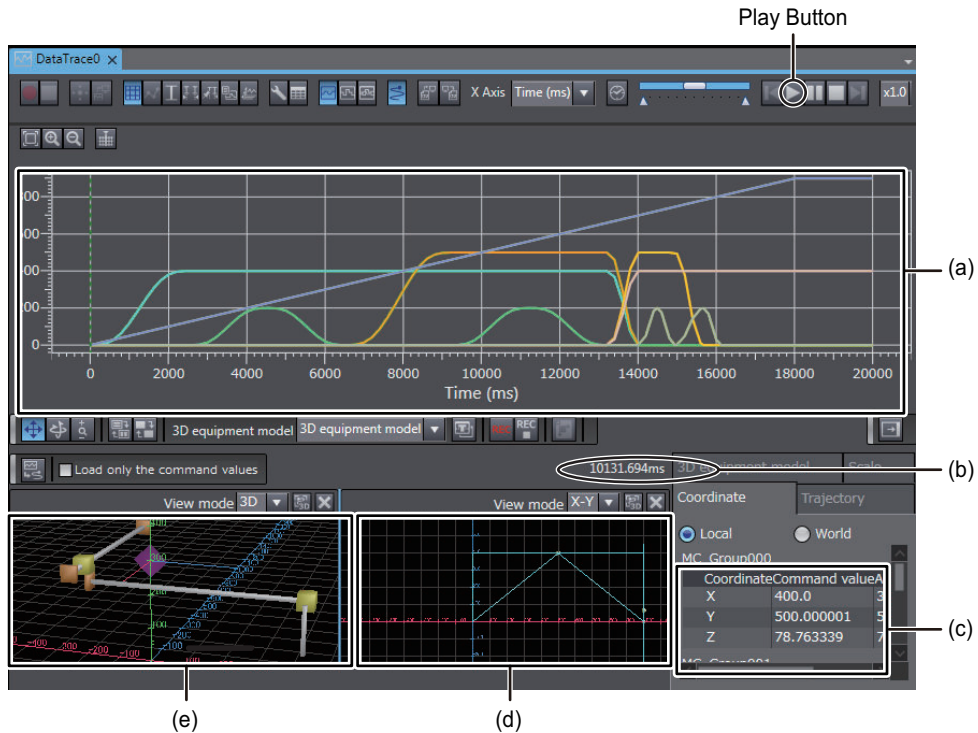

	Items that move synchronously
(a)	The cursor on the trace graph
(b)	The elapsed time from the start of the trace
(c)	The 3D machine model coordinate values
(d)	The 2D display cursor
(e)	The 3D equipment model



Additional Information

- You can also perform 3D motion monitoring when the Sysmac Studio is connected to the Simulator. When the Sysmac Studio is connected to the Simulator, perform steps 4 and 5 for the Simulator instead of the Controller.
- You can export trace data to save it in a CSV file and then import the data later to check operation. Refer to *7-2-11 Data Tracing* on page 7-53 for the operating procedures to import and export trace data.
- If 3D Motion Monitor is displayed on other Data Trace Tab Pages, the 3D motion monitor graph is displayed only on the tab page with the focus. During that time, the following message is displayed on the other Data Trace Tab Pages: *The 3D Motion Monitor is displayed on another view. Click this view to display the 3D Motion Monitor again here.*

Recording 3D Equipment Model Operation

Click the **Record** Button to save the 3D equipment model operation into an AVI file. Click the **Stop** Button to stop recording.

● 2D Path Display

The 2D paths of the markers for the projections in the 3D display are also shown.

The 2D path appears when you select **X-Y**, **Y-Z**, or **X-Z** in the box to switch between 3D/2D path displays on the 3D Motion Monitor View.

- Optimizing Camera Position and Scale

The axis scale resolution and camera position are automatically optimized so that the entire path fits onto the display.

- Viewpoint Manipulation Restrictions

On the 2D path display, you can only zoom in or zoom out. You cannot move or rotate your viewpoint.

- Hidden Virtual 3D Machines

Even if virtual 3D machines are currently shown on the 3D path display, these virtual 3D machines are not shown on the 2D path display.

Display When X-Y Is Selected

This is what appears when you select **X-Y** in the box to switch between 3D/2D path displays on the 3D Motion Monitor View. In this case, the horizontal axis is the X axis and the vertical axis is the Y axis.

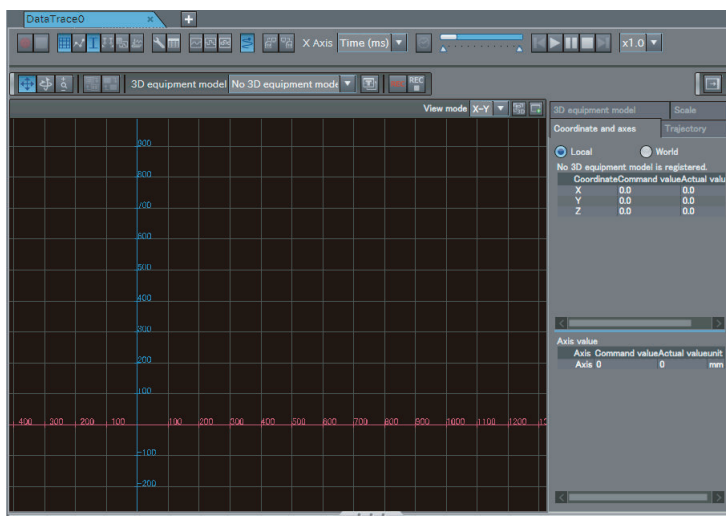

Display When Y-Z Is Selected

This is what appears when you select **Y-Z** in the box to switch between 3D/2D path displays on the 3D Motion Monitor View. In this case, the horizontal axis is the Y axis and the vertical axis is the Z axis.

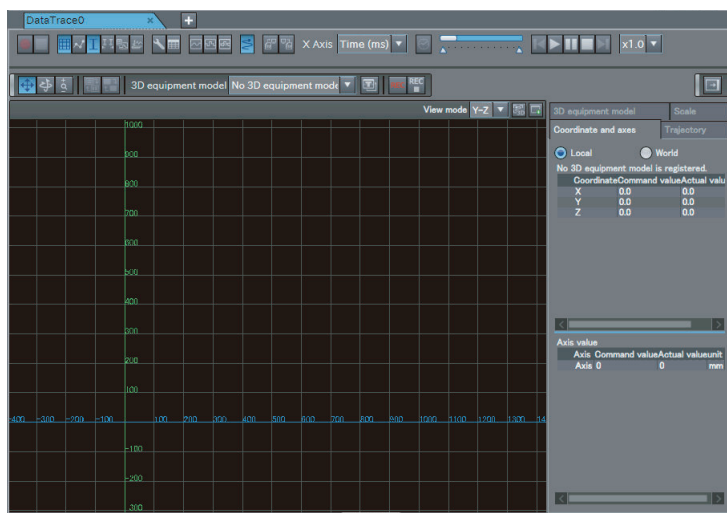

Display When X-Z Is Selected

This is what appears when you select X-Z in the box to switch between 3D/2D path displays on the 3D Motion Monitor View. In this case, the horizontal axis is the X axis and the vertical axis is the Z axis.

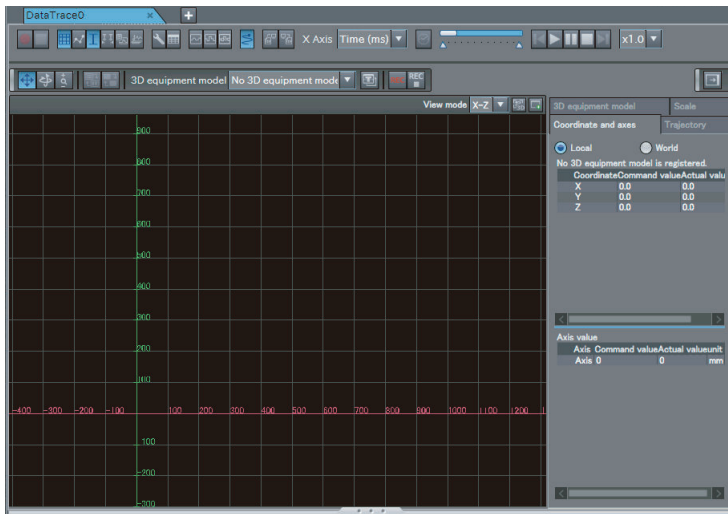



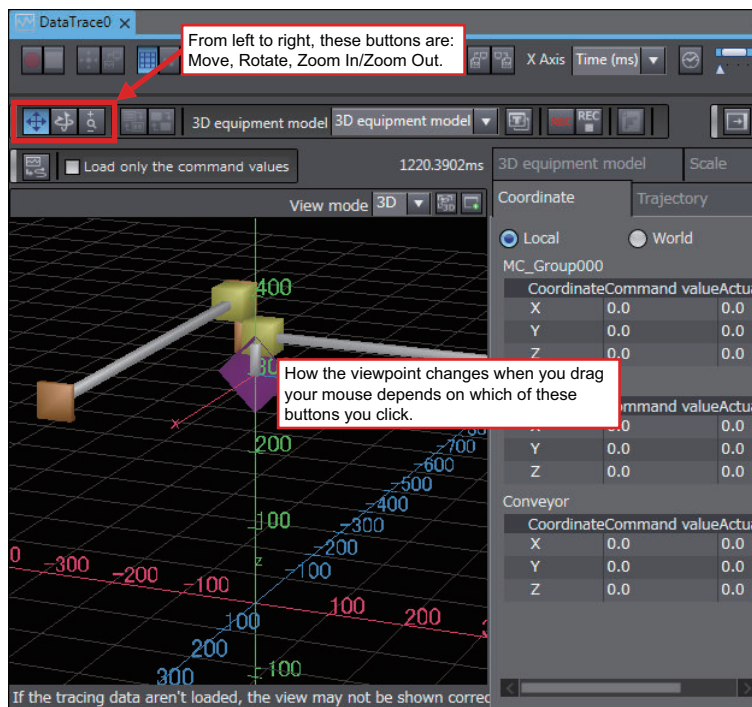

● Operations on the 3D Motion Monitor View

Viewpoint Operations

The movement of the mouse cursor affects the viewpoint depending on which of the three viewpoint operation buttons is currently selected.



Button	Icon	Function
Move Viewpoint Button		The mouse cursor changes when you click this button. This button allows you to drag the mouse around to change your viewpoint up, down, left, or right in the 3D rendering area.

Button	Icon	Function
Rotate Viewpoint Mode Button		The mouse cursor changes when you click this button. This button allows you to drag the mouse around to rotate your viewpoint around the center of the 3D display area of the Preview Area.
Zoom In/Zoom Out Button		The mouse cursor changes when you click this button. This button allows you to drag the mouse around to zoom in or zoom out in the 3D display area.
Overhead View Button		Click this button to automatically move the camera so that you can display the entire equipment model from overhead in the Preview Area.

You can also use the following keyboard shortcuts to change how you want to change the viewpoint.

Shift: Move

Ctrl: Rotate

Shift + Ctrl: Zoom In/Zoom Out

If your mouse has a mouse wheel, you can scroll the wheel up or down to zoom in and zoom out.

Displays

Click the Add Display Button () to add another display that is the same as the current display.

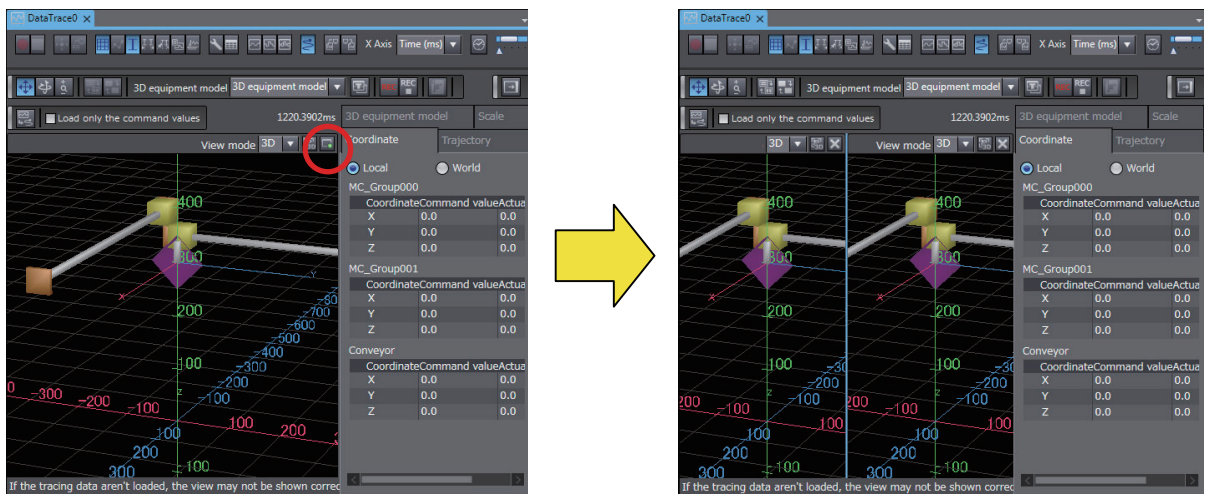

You can now change the viewpoint independently for these two displays.

Example: Overhead View and End Effector Focus

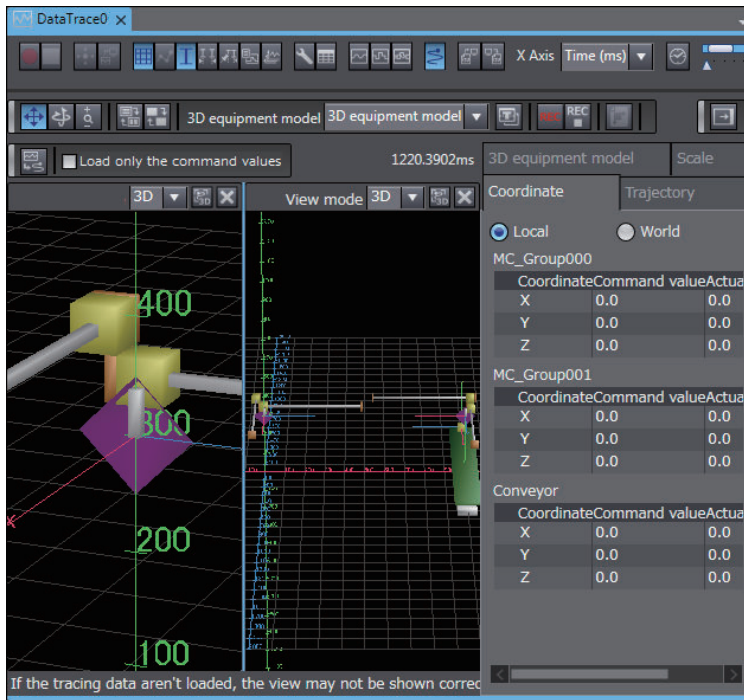

2D Path Display

In the View Mode Box, change **3-D** to **X-Y**, **Y-Z**, or **X-Z** to display the motion path on a 2D plane.

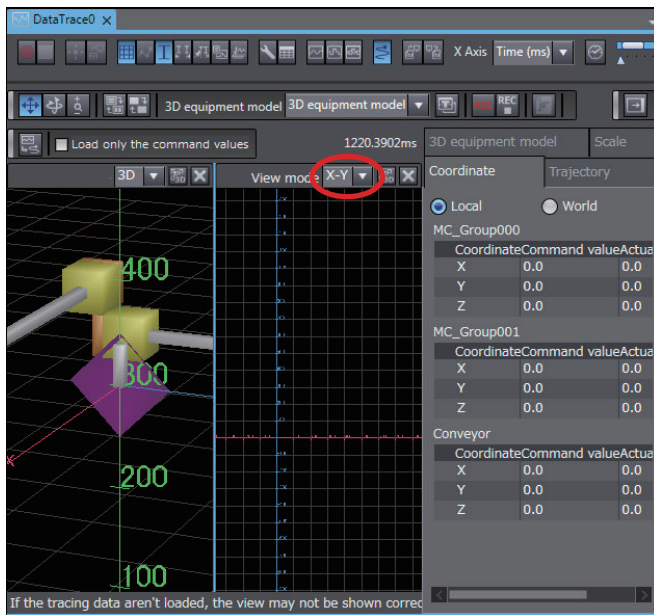

Reading Trace Data

You can click the trace data loading button () to load the most recent trace data and update the 3D Motion Monitor View.

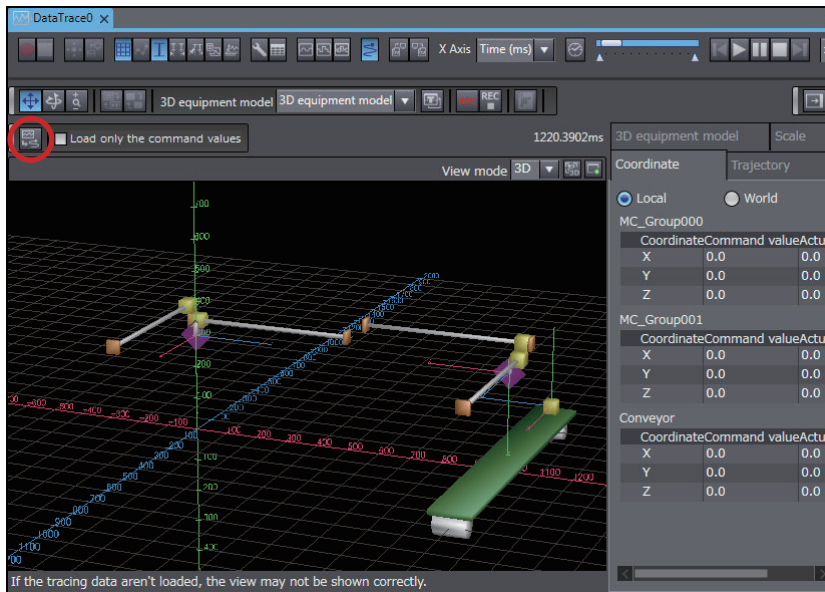

Item	Description
Load only the command values Check Box	If you select this check box and read the trace data, only the command values are used to draw the operation and trajectory of a 3D equipment model.



Precautions for Correct Use

Even if you redisplay the 3D Motion Monitor View, the data is not updated until the trace data loading button is clicked. Even if you change the 3D equipment model or otherwise redisplay the 3D Motion Monitor, the 3D Motion Monitor display may not agree with the actual trace data. To change the trace data, click the trace data loading button to update the display.



Additional Information

If the trace data is updated while the 3D Motion Monitor is displayed, e.g., when the data trace is completed, traced variables are deleted, or trace results are imported, a dialog box will appear to confirm loading the trace data. Click the **Yes** Button in the dialog box to load the most recent trace data and update the display.

Creating 3D Equipment Models

You can create a 3D equipment model at the control target to monitor with 3D motion monitoring.



Precautions for Correct Use

This function is not supported by the Sysmac Studio (64 bit). The Display 3D Motion Monitor Button is not displayed.

Procedure

- 1 Start the data trace and click the Display 3D Motion Monitor Button (.

- 2 Click the Settings Button () for the 3D equipment model in the 3D Motion Monitor View and select **Add** from the menu.

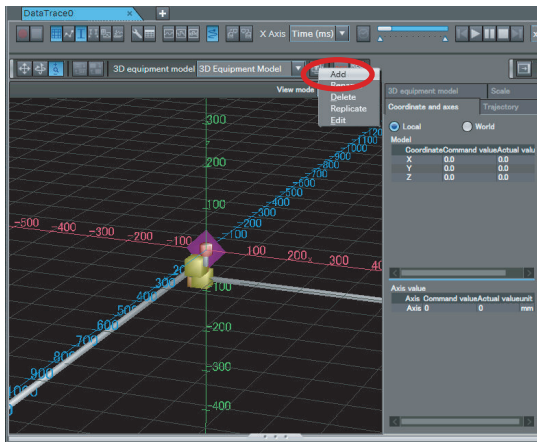

The 3D Equipment Model Display appears.

- 3 Click the Overhead View Button () in the Preview Area at the bottom of the 3D Equipment Model Display.

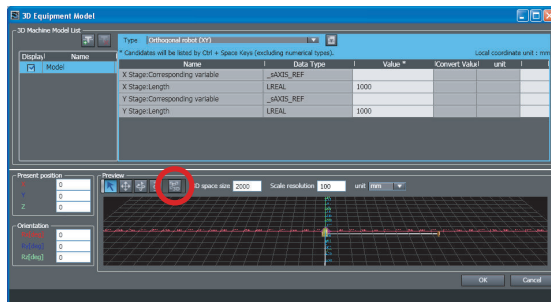

The camera is positioned so that the entire device model can be seen from overhead in the Preview Area.

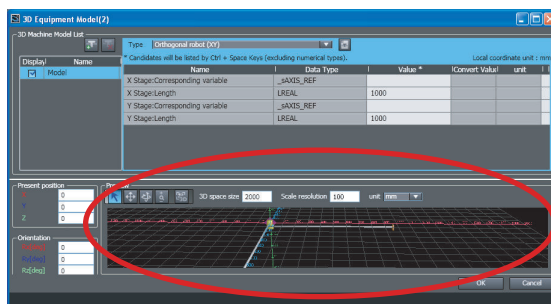

- 4 Set the parameters, and then click the **OK** Button. The 3D equipment model is added. The parameters are described below. The 3D Equipment Model Window is made up of three sections. The procedures to set up these sections are given below.

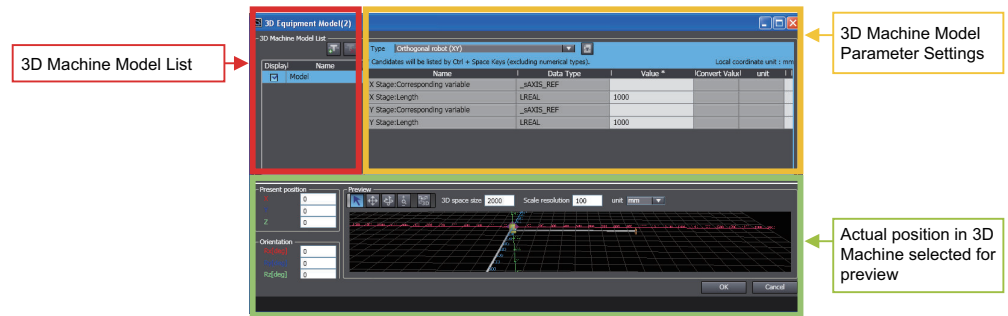

● 3D Machine Model List

- You can edit the 3D machine model names in this list. If the name you enter conflicts with another name elsewhere, an icon (❗) is displayed to indicate the error.
- You can click any check box in the list to select a 3D machine model. The color of the check box that you select turns blue, and the parameter settings for that 3D machine model are shown in the yellow-framed area on the right side of the figure above.
- Clear the check boxes beside the 3D machine models you do not want to display when you perform a 3D equipment motion test. Make sure that unwanted 3D machine models do not appear in the Preview Area.
- Click the Add Button to add a 3D machine model to the list.
- Click the Delete Button to delete a 3D machine model from the list. After you click the button, click the line of the 3D machine model you want to delete.
- When the 3D machine model display first appears, the first 3D model name in the list is selected automatically.

● 3D Machine Model Parameter Settings

Select a 3D machine type in the Type Box.

Next, set the parameters for the 3D machine length, rotation direction for rotational axes, and corresponding axes to link axis variables with the movable parts of the 3D machine. The specific parameters depend on the type of 3D machine.



Additional Information

For an axes group in the Motion Control Function Module, select 2, 3, or 4 axes.

The following is an example of the parameter settings for an XYZ stage + rotational axis (upward) 3D machine.

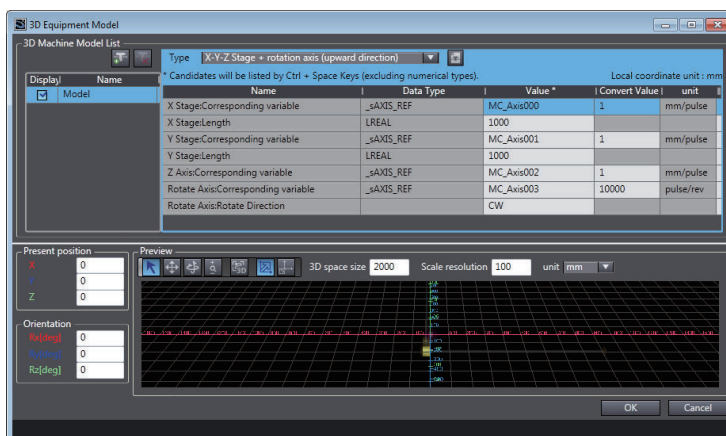

Item	Setting
X Stage: Length	1000
Y Stage: Length	1000
Rotate Axis: Rotate Direction	CW (or CCW)
Corresponding axis settings	Enter the following variables directly into the text boxes, or press the Ctrl + Space Keys and select them from the list. Axis <i>MC_Axis000</i> for X stage, Axis <i>MC_Axis001</i> for Y stage, Axis <i>MC_Axis002</i> for Z axis, Axis <i>MC_Axis003</i> for rotational axis Note The axes that you added in the previous section, <i>Axis Settings for 3D Equipment Models</i> , will appear in the boxes in the Value Column.
Present position	0,0,0
Orientation	0,0,0

● Preview

The 3D machine you have set up appears in the 3D coordinate system (world coordinates). The position and orientation of the 3D machine is determined by the coordinate values.

Operations in the 3D Display

Button	Icon	Function
Selection Mode Button		The mouse cursor changes when you click this button. This allows you to select the 3D machines or other models in the Preview Area with your mouse. Use this button to switch between Move Viewpoint Mode (described below) and Selection Mode.
Move Viewpoint Button		The mouse cursor changes when you click this button. This button allows you to drag the mouse around to change your viewpoint up, down, left, or right in the 3D display area in the Preview Area.
Rotate Viewpoint Mode Button		The mouse cursor changes when you click this button. This button allows you to drag the mouse around to rotate your viewpoint around the center of the 3D display area of the Preview Area.
Zoom In/Zoom Out Button		The mouse cursor changes when you click this button. This button allows you to drag the mouse around to zoom in or zoom out in the 3D display area of the Preview Area.
Overhead View Button		Click this button to automatically move the camera so that you can display the entire device model from overhead in the Preview Area.

Button	Icon	Function
Coordinate System Buttons		<p>Click one of these buttons to change to a right-handed or left-handed coordinate system for the equipment model display.</p> <ul style="list-style-type: none"> • Rotation direction for right-handed coordinate system: Right-hand thread direction • Rotation direction for left-handed coordinate system: Lefthand thread direction

3D Space Size

You can change the coordinate axes of the 3D space and the size of the grid plane. If you change the size of the 3D space, the length of the coordinate axes and the size of the grid in the Preview Area also change.

Scale Resolution

You can change the scale resolution of the coordinate axes.

Unit

Select the coordinate axis scale unit from the following units: μm , nm, mm, cm, m, inches, or feet.



Precautions for Correct Use

If you create a new 3D equipment model on Sysmac Studio version 1.14, the unit will be fixed at millimeters.

● Present Position

The position gives the home position where the 3D machine model is placed in the 3D coordinate system (world coordinates) in the Preview Area. You can change this position by entering the difference (X, Y, Z) from the world coordinate home (0, 0, 0) where you would like the placement home for the model to be. The position in the Preview Area is represented by two purple square pyramids.

● Orientation

The orientation is the angle of rotation of the 3D machine model local axes (Rx, Ry, Rz) centered around the placement home point in 3D world coordinates.



Precautions for Correct Use

The rotation direction for a left-handed coordinate system is different for Sysmac Studio version 1.13 or lower and Sysmac Studio version 1.14 or higher.

- Sysmac Studio version 1.13 or lower: Left-handed coordinate system, right-hand thread direction
- Sysmac Studio version 1.14 or higher: Left-handed coordinate system, left-hand thread direction

Therefore, if you open a 3D equipment model that was created on Sysmac Studio version 1.13 or lower on Sysmac Studio version 1.14 or higher, the sign of all orientation values is reversed.

● Placement Home

Click the shape made up of two purple square pyramids in the Preview Area. The local axes (X, Y, Z) are displayed. Drag these local axes with your mouse to place the object directly in the Preview Area. Select between position and orientation to modify the actual position and angle of rotation of the model.

Setting Example

In the following example, we add one orthogonal robot (XYZ + rotational axis) 3D machine and create equipment made up of two orthogonal robots.

- 1 Click the Add Button (+) in the 3D Machine Model List to add another 3D machine.
A new model is added to the 3D Machine Model List.

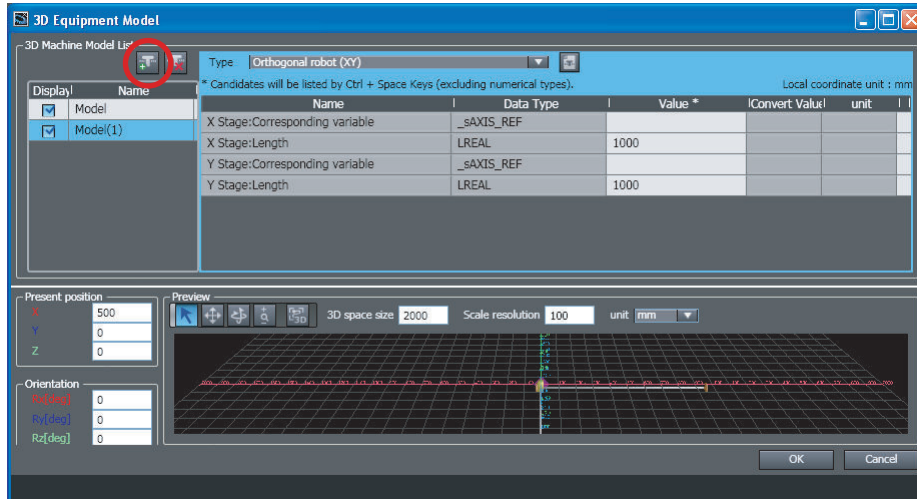

- 2 Select a 3D machine type in the Type Box.

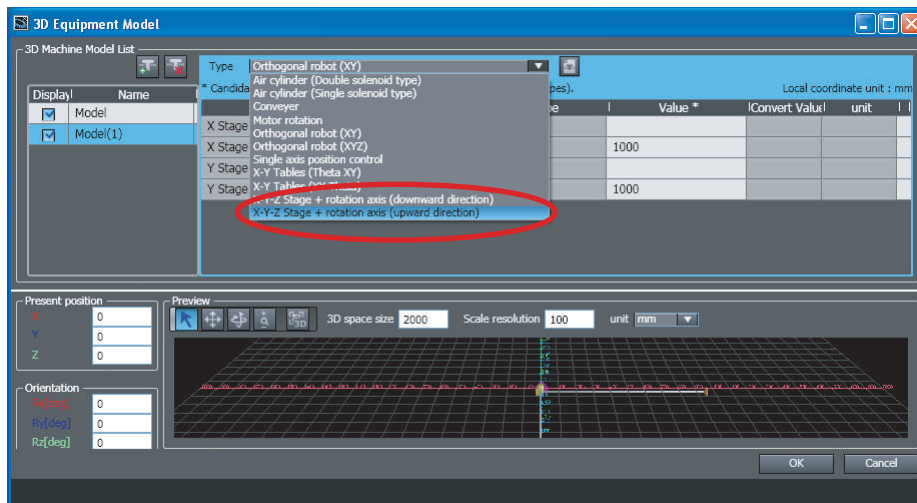

- 3 Move the position of the 3D machine 500 (mm) along the X axis. Enter 500 into the "X" text box in the Present Position Area. Confirm that the 3D machine changed positions in the Preview Area.

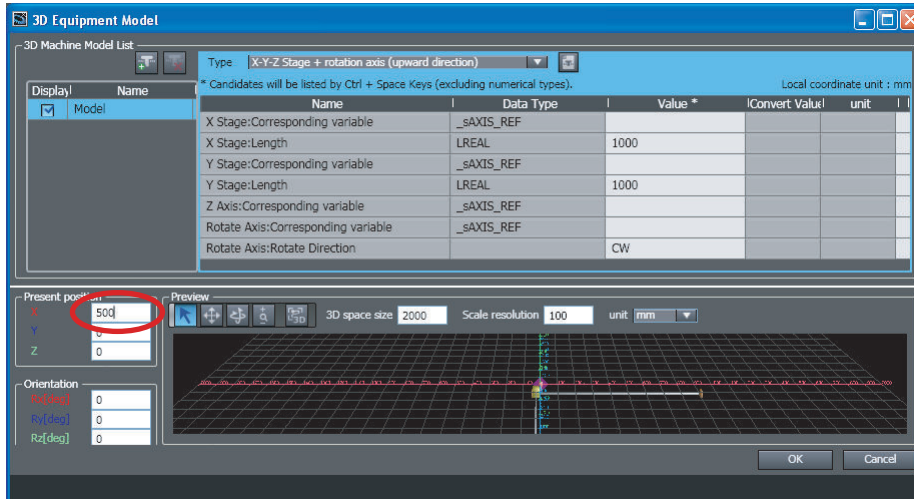

4 Click the **OK** Button.

The information you entered is saved, and the 3D Equipment Model Display closes.

A table representing the two orthogonal robots is added and the coordinate values for the end effector position of each robot appears in the 3D Motion Monitor.

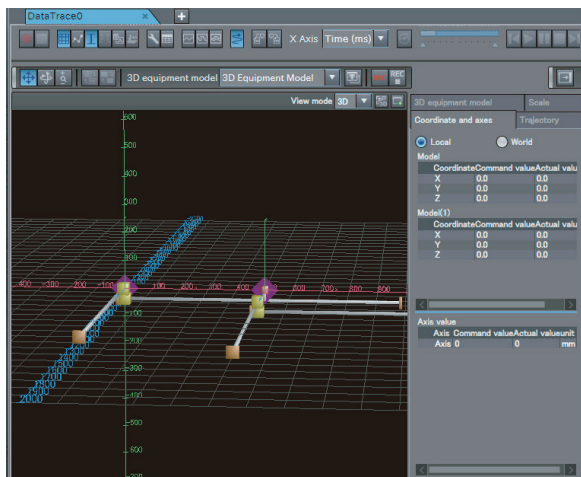

7-2-12 Output Factor Search

Output Factor Search is a function that searches for the rungs that causes an output among the elements of a ladder program in the Controller, and displays them in a tree structure. If you obtain an unexpected output in a ladder program, performing an output factor search makes it easier to identify what causes the output.

Output factor search targets the following circuit parts in ladder programs.

- Output
- Inline ST (Output factor search cannot be performed from inside an inline ST.)
- Function
- Function block
- Jump
- Parameter on the output side of function or function block

Overview of the Search Output Factor Tab Page

Circuit Parts	Variable Comment	POU	Rung Number	Rung	Task Name	Note
		Program0.Section0	0		PrimaryTask	Why is "e" TRUE?
		Program0.Section0	1		PrimaryTask	OK with "a" being TRUE.
		Program0.Section2	1		PrimaryTask	Something is odd with "c" being TRUE in this state. "bb" should be FALSE.
		Program0.Section0	2		PrimaryTask	
		Program0.Section2	2		PrimaryTask	

Item	Description
Circuit Parts	Displays the circuit parts that are the starting points for the output factor search. The present values are displayed when monitoring is enabled, such as when online or when a simulation is in progress.
Variable Comment	Displays the comments set for the variable assigned to each circuit part in the ladder program.
POU	Displays the names of POUs that include the rungs searched. For rungs included in a section, the displayed names will be <i>POUName.SectionName</i> .
Rung Number	The displayed rung numbers are different depending on the program type. <ul style="list-style-type: none"> Ladder program: Displays the rung numbers of the rungs searched. ST program: Displays the line numbers of the rungs searched. Inline ST program: Displays the rung numbers and line numbers of the rungs searched.
Rung	Displays the rungs that include the circuit parts. The present values are displayed with the TRUE/FALSE status when monitoring is enabled, such as when online or when a simulation is in progress.
Task Name	Displays the name of the task to which the program POUs that include the rungs searched are assigned.
Note	You can enter any content in the text boxes.

As shown in the figure below, the circuit parts of the output rungs displayed in the **Rung** column are displayed in a tree structure in the **Circuit Parts** column.

Circuit Parts	Variable Comment	POU	Rung Number	Rung
		Program0.Section0	0	
		Program0.Section0	1	
		Program0.Section2	1	
		Program0.Section0	2	
		Program0.Section2	2	



Precautions for Correct Use

If you close the Search Output Factor Tab Page, the search results and the contents that you entered in the **Note** column will be discarded.

Procedure for Output Factor Search

● Displaying the Search Output Factor Tab Page

- 1 Double-click the ladder program, ladder function, or ladder function block under **Programs** in the Multiview Explorer.
The rungs are displayed on the Ladder Editor.
- 2 Right-click the circuit part for which you want to identify the output factor and select **Search Output Factor**. Or, select the circuit part for which you want to identify the output factor and press **Ctrl + O** Keys.

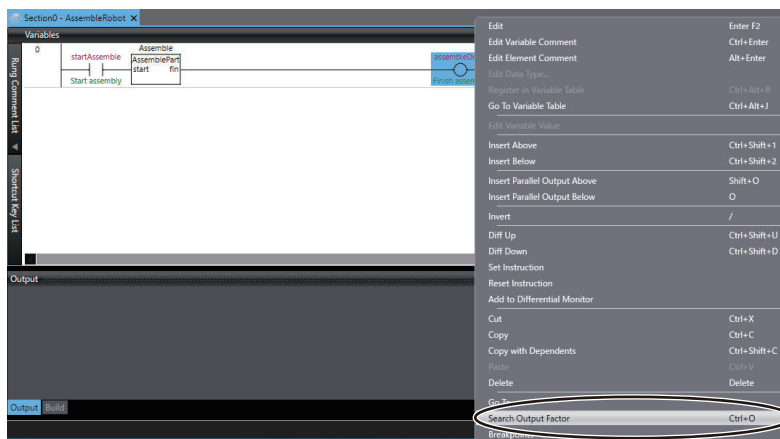

The ladder diagram rung that includes the target of the output factor search is displayed on the Search Output Factor Tab Page.

Circuit Parts	Variable Comment	POU	Rung Number	Rung	Task Name	Note
assembleDone	Finish assembly	AssembleRobot.Section0	0		PrimaryTask	

● Searching the Output Rungs

To determine in which rung the input that causes the output is output, search the output source rung for the input.

- 1 On the Search Output Factor Tab Page, right-click the circuit part for which to search the output source rung and select **Search Output Rung** from the menu.

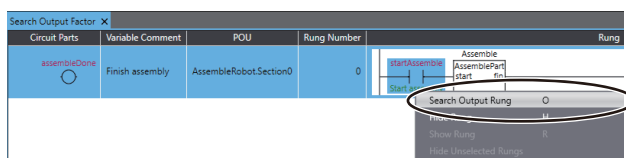

The target output rung is displayed under the selected circuit part.

Search Output Factor X		Circuit Parts	Variable Comment	POU	Rung Number	Rung	Task Name	Note
	assembleDone	Finish assembly	AssembleRobot.Section0	0		PrimaryTask		
	startAssemble	Start assembly	Program0.Section0	2		PrimaryTask		

Repeat this operation until you find the cause of the unexpected output.



Precautions for Correct Use

The search results will be discarded if you close the Search Output Factor Tab Page.

● Hiding the Selected Rung

You can hide rungs that you do not want to display. If the ladder program has a complex structure, reducing the number of rungs displayed makes it easier to analyze the cause of the unexpected output.

- 1 Right-click the target rung and select **Hide Rung** from the menu. The selected rung is hidden.

Search Output Factor X		Circuit Parts	Variable Comment	POU	Rung Number	Rung	Task Name	Note
	assembleDone	Finish assembly	AssembleRobot.Section0	0		PrimaryTask		
	startAssemble	Start assembly	Program0.Section0	2		PrimaryTask		

● Hiding Unselected Rungs

- 1 Right-click the rung that includes the target path and select **Hide Unselected Rungs** from the menu. Rungs other than the rung that includes the selected path are hidden. However, the rungs in the root of the hierarchy will not be hidden.

● Hiding All Rungs

- 1 Right-click on the Search Output Factor Tab Page and select **Hide All Rungs** from the menu. All rungs, including the rungs in the root of the hierarchy, will be hidden.

● Displaying the Selected Rung Again

You can again display rungs hidden on the Search Output Factor Tab Page.

- 1 Right-click the rung to display again and select **Show Rung** from the menu. The selected rung is displayed again.

● Displaying Rungs on the Selected Path Again

- 1 Right-click the rung that includes the target path and select **Show Selected Rungs** from the menu.

The rungs on the selected path are displayed again.

● Jumping to the Relevant Location

Once you have identified the rung that is the factor of the unexpected output on the Search Output Factor Tab Page, you can go to the rung to correct.

- 1 Right-click the target rung and select **Jump to Editor** from the menu. Or, double-click the circuit part to correct.
The ladder program for the selected rung is displayed.

● Deleting the Selected Rung

You can delete rungs that are not relevant to the cause of the unexpected output on the Search Output Factor Tab Page. If the ladder program has a complex structure, reducing the number of rungs displayed makes it easier to analyze the cause of the unexpected output.

- 1 Right-click the target rung and choose **Delete Rung** from the menu.
The selected rung is deleted.

● Deleting Unselected Rungs

- 1 Right-click the rung that includes the target path and select **Delete Unselected Rungs** from the menu.
Rungs other than the rung that includes the selected path are deleted.

● Expanding the Selected Tree

You can expand the tree of output rungs to make the Search Output Factor Tab Page easier to view.

- 1 Right-click the target rung and select **Expand Rung** from the menu. Or, click the + button on the left side of the tab page.
The tree is expanded.

● Expanding All Trees

- 1 Right-click on the Search Output Factor Tab Page and select **Expand All** from the menu.
All collapsed trees are expanded.

● Expanding All Subelements

- 1 Right-click the target rung and select **Expand All Sub elements** from the menu.
All collapsed subelements in the rung are expanded.

● Collapsing the Tree

- 1 Right-click the target rung and choose **Collapse Rung** from the menu. Or, click the - button on the left side of the tab page.

The tree is collapsed.

● Collapsing All Trees

- 1 Right-click on the Search Output Factor Tab Page and select **Collapse All** from the menu. All expanded trees are collapsed.

● Collapsing All Expanded Rungs

- 1 Right-click on the Search Output Factor Tab Page and select **Collapse All** from the menu. All expanded rungs are collapsed.

● Collapsing Unselected Rungs

- 1 Right-click the rung that includes the target path and select **Collapse Unselected Rungs** from the menu. Rungs other than the rung that includes the selected path are collapsed.

● Searching the Rung Again (Refresh)

When program editing is enabled, such as when offline or when online editing is in progress, you can edit a rung in the Ladder Editor and then search the rung again in the Search Output Factor Tab Page to refresh the search results to display the call relationship after editing.

- 1 With the Search Output Factor Tab Page open, edit a rung in the Ladder Editor. Right-click the rung on the Search Output Factor Tab Page and select **Search Again (Refresh)** from the menu. The rung on the Search Output Factor Tab Page is refreshed to display the edited content.

● Searching the Rung Again (Add)

When program editing is enabled, such as when offline or when online editing is in progress, you can edit a rung in the Ladder Editor and then search the rung again on the Search Output Factor Tab Page to add the rung after editing to the displayed search results. Adding a path to the output factor to search for on the Search Output Factor Tab Page allows side-by-side comparison of rungs before and after addition.

- 1 With the Search Output Factor Tab Page open, edit a rung in the Ladder Editor. Right-click the rung on the Search Output Factor Tab Page and select **Search Again (Add)** from the menu. The rung is searched again and added to the displayed search results.

7-3 Offline Debugging

Offline debugging allows you to debug a program when you are not connected online to a Controller. You can debug on a Simulator to check control program logic before transferring the project to the Controller.

CAUTION

- Although the Simulator simulates the operation of the Controller, there are difference from the Controller in operation and timing. After you debug the user program on the Simulator, always check operation on the physical Controller before you use the user program to operate the controlled system.
Accidents may occur if the controlled system performs unexpected operation.
- The Simulator instructions are not processed on the physical Controller and all outputs from the instructions will be FALSE. After you debug the user program on the Simulator, always check operation on the physical Controller before you use the user program to operate the controlled system.
Accidents may occur if the controlled system performs unexpected operation.
- Simultaneous simulation for offline debugging of sequences and the HMI can be performed to simulate the linked operation of the Controller and HMI. However, there are differences in the operation and timing between this simulation and the actual combination of the HMI and Controller. After you debug operation with the simulation, always check operation on the physical Controller and HMI before you use them in the actual system.
Accidents may occur if the controlled system performs unexpected operation.



7-3-1 Debugging with Program Simulation

To debug a control program, it is best to simulate the control program on the computer first to check the operation logic and parameter settings. This process is called simulation debugging. The Sysmac Studio comes with a Simulator that emulates all CPU Unit functions.

Simulation Procedures

Use the following procedure to start the Sysmac Studio and connect to the Simulator.

- 1 Start the Sysmac Studio and create a project.
- 2 Select **Simulation Pane** from the **View** Menu.

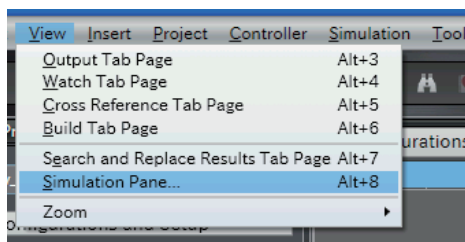

The Simulation Pane is displayed below the Toolbox Pane on the right of the window.

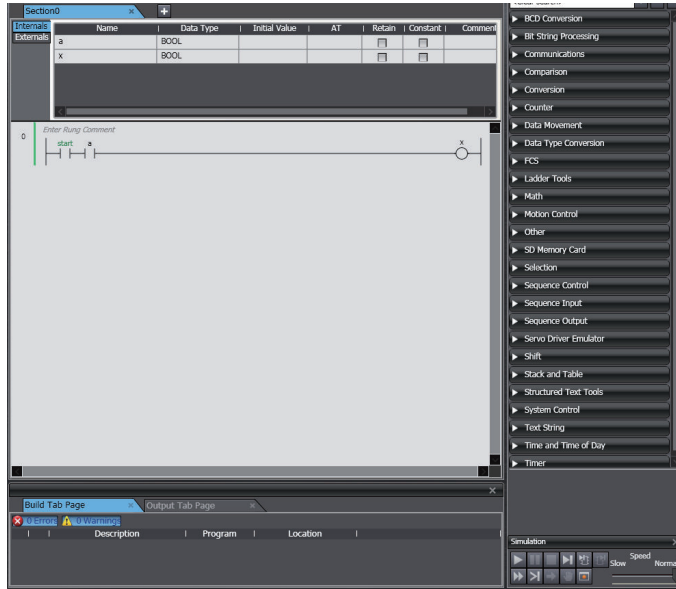

- 3 Use the Sysmac Studio to set the Controller Configurations and Setup and create a program.
- 4 Select **Build Controller** from the **Project** Menu to build the user program.
If you changed the programs, select **Build Controller** from the **Project** Menu to build them again.
- 5 If you want to execute a specific task or only a part of a section or program, select the item for simulation under **Programming – Tasks** in the Multiview Explorer. (Refer to *Setting Simulation Programs* on page 7-88.)
- 6 Click the **Run** Button in the Simulation Pane. Or, select **Run** from the **Simulation** Menu.



- 7 After the Simulator is started and connected, the Online Indicator in the Controller Status Pane is lit green and *Simulator* is displayed. In this status, the project is completely transferred to the Simulator and RUN mode continues.



- 8 To stop the simulation, click the **Stop** Button in the Simulation Pane.



The connection to the Simulator is broken and the Simulator is exited.

- 9 To end the simulation, click the Close Button (✕) in the Simulation Pane.



Precautions for Correct Use

You can start a simulation even if the user program exceeds the memory size. Check memory usage before you transfer the user program to the Controller. Refer to *8-4 User Memory Usage Monitor* on page 8-49 for the confirmation procedure.



Additional Information

You can start the Simulator in PROGRAM mode during simulation execution. Select **Run in PROGRAM mode** from the **Simulation Menu**.
Select **Mode – RUN Mode** from the **Controller Menu** to change to RUN mode after starting the Simulator in PROGRAM mode.

Setting Simulation Programs

● Simulation Programs

You can set the task or programs to simulate. You can choose to simulate some or all of the programs in the user program.

● Procedure for Setting Simulation Programs

- 1 Select **Simulation Pane** from the **View Menu**.

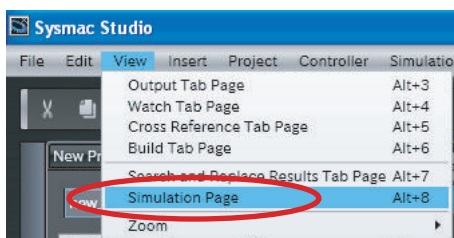

The Simulation Pane is displayed.

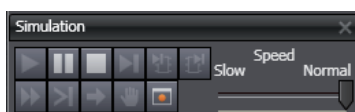

A check box is displayed to the left of the names of programs listed under **tasks** in the Multi-view Explorer to designate **programs** for simulation.

These check boxes are selected by default.

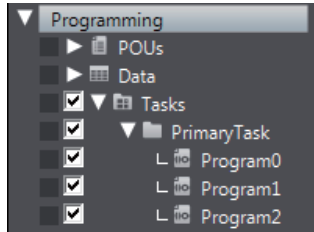

- 2 Clear the check boxes in the Multiview Explorer for any tasks, programs, or sections you do not want to simulate.

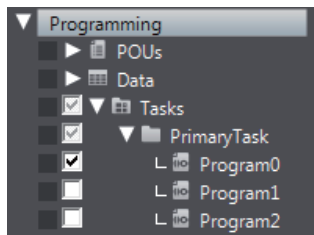

Simulations are performed only for the selected tasks and programs.

Setting the Debug Programs

● Debug Programs

A debug program is program code used for offline debugging. This code contains instructions to perform virtual input processing on inputs received from outside of the Controller, force user-defined errors, and perform other such debugging tasks.

The debug program attributes can be set for each program. These programs can be executed only on the Simulator. Simulation programs are treated as normal programs by the Simulator. Assign them to a task to execute them. Debug programs are not included in the Simulator's estimation of execution times. This can increase the accuracy of the time estimates.

● Procedure for Setting Debug Programs

- 1 Right-click the program to debug in the Multiview Explorer and select **Settings For Debugging - Enable** from the menu.

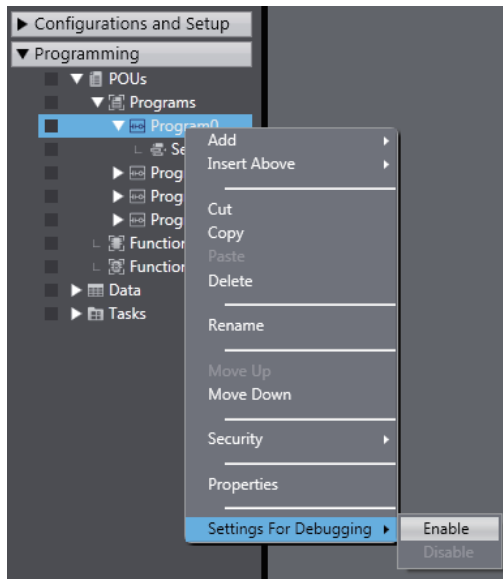

The program is given a debug program attribute.

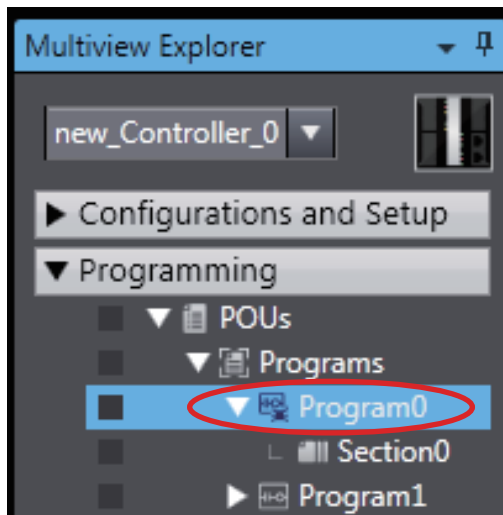

- 2 Double-click the debug program.
The Ladder Editor or ST Editor is displayed.
- 3 Enter program code to test (virtual input processing, forcing user-defined errors to occur, etc.).

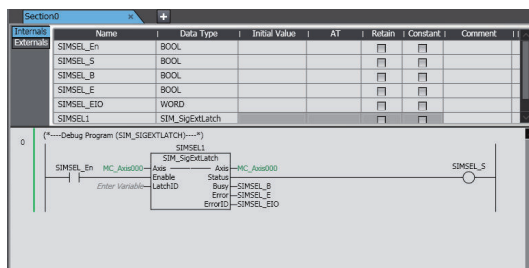

- After you have written a program as a debug program, you can right-click the debug program and select **Settings For Debugging - Disable** to change the program to a normal program.

4 Assign the completed debug program to a task.

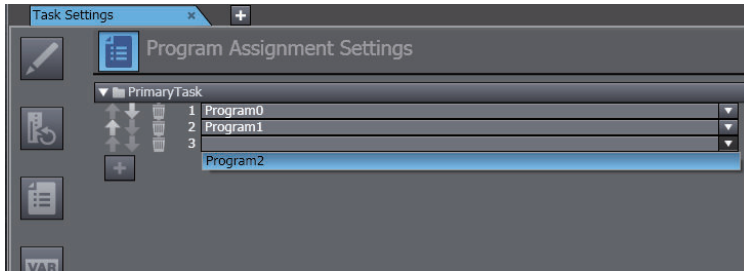

● **Debug Program Example with Special Instructions**

The following example shows a debug program that uses special simulation instructions. You can use the simulation instructions only in the Debug Program Editor. Refer to *A-7 Simulation Instructions* on page A-38 for details.

Main Program Example

An external signal is used to record the latch position for axis 0. Execution of positioning continues.

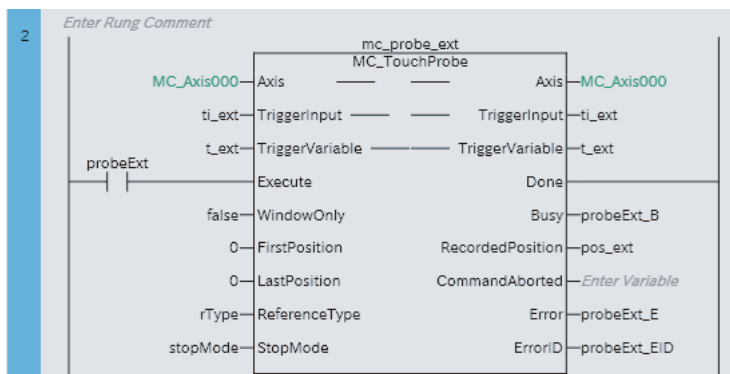
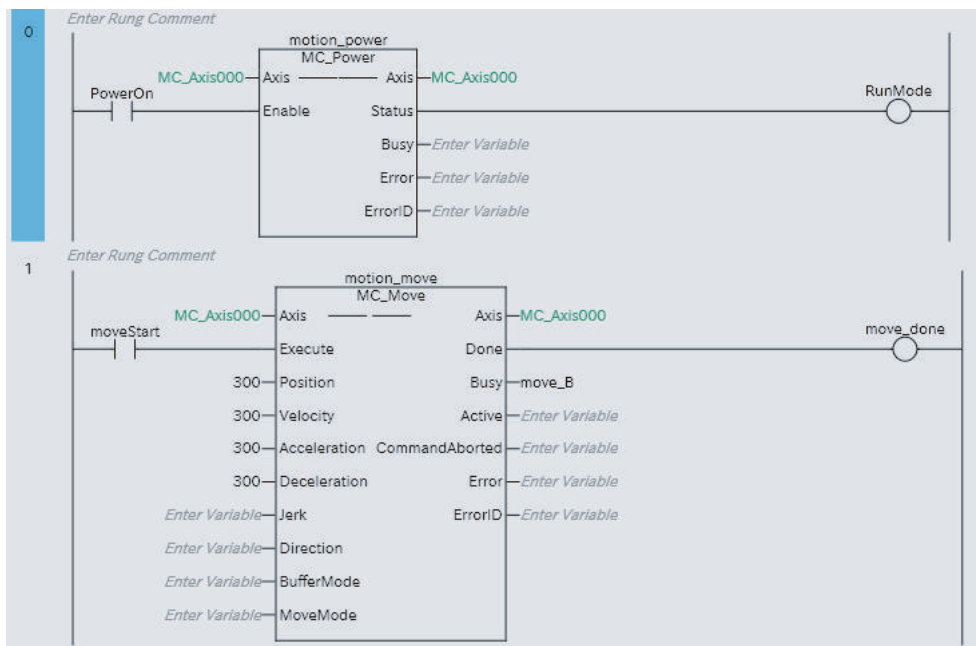

Debug Program Example

When SIMSEL_En turns ON, an external input signal is sent to LatchID (1) for axis 0.

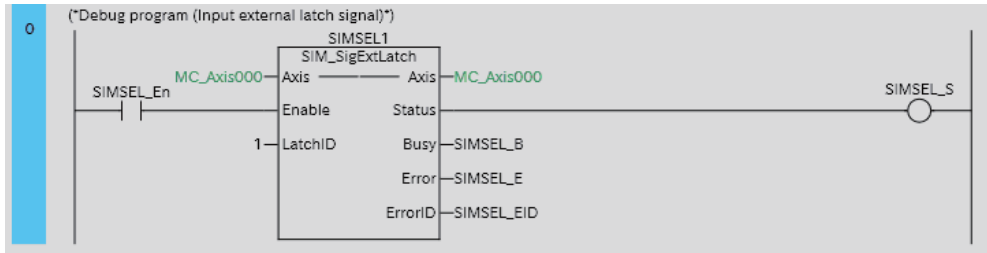

You can check the operation of the debug program by performing a data trace.

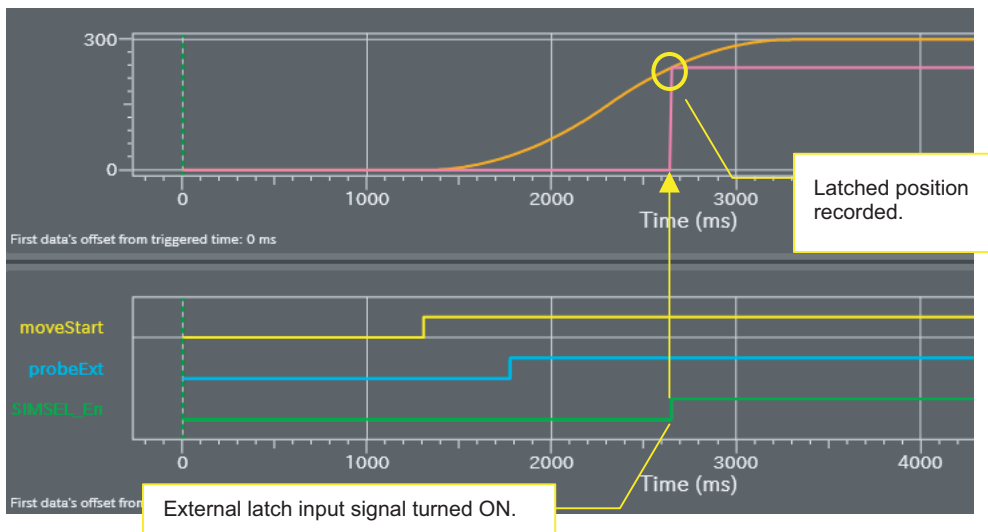

Estimating Task Execution Times

The time required from the beginning of task execution until it ends is approximated through a simulation.

- You can display the estimated average and maximum task execution time for both the execution of periodic tasks and for system services^{*1} that are executed from when task execution is started until it is completed.
- You can use the estimated times as a guide in determining task periods.

Run the Simulator in Execution Time Estimation Mode after you have calibrated execution time estimation.

*1. This is displayed only for an NJ-series Controller.



Precautions for Correct Use

- The estimated times are not necessarily the same as the actual task execution times on the physical Controller. Depending on the user program, I/O configuration, and whether communications are used the execution times on the physical control may exceed the estimated maximum value. Use the estimated times as a guide in determining task periods.
 - With an NX-series Controller, you can display estimated values only for the primary periodic task.
 - You cannot display the estimated values on NY-series Controllers.
 - You can calculate the estimated values for the priority-5 periodic task of an NX701 Controller on paper. Refer to *Estimating the Task Execution Time of the Priority-5 Periodic Task of an NX701 Controller* on page 7-97.
-



Additional Information

- The system services for NX701 Controllers are executed in parallel with other processes. They are not displayed in the Task Execution Time Monitor because they do not affect the task execution time.
 - You can calculate the estimated values for the task execution time of an NY-series Controller on paper. Refer to the *NY-series Industrial Panel PC / Industrial Box PC Software User's Manual (Cat. No. W558)* for details on the calculation method.
-

● Calibrate for Execution Time Estimates

To calculate estimated program execution times, calibration is performed for the relative performance of the physical Controller and the CPU of the computer.

To run the Simulator in Execution Time Estimation Mode, perform this procedure on the target Controllers at least once after installing the Sysmac Studio or after auto-updating the software to add new models.



Additional Information

Perform the following operations before you calibrate for execution time estimation.

- Except for this utility, exit all applications that are running on the computer, including the Sysmac Studio. This utility will continue operation even if you close the Sysmac Studio.
 - If you are using a notebook computer, set the Power Options to *High performance*.
-

Procedure

- 1 Select **Calibration** from the **Simulation** Menu.
The calibration tool for execution time estimation is started.

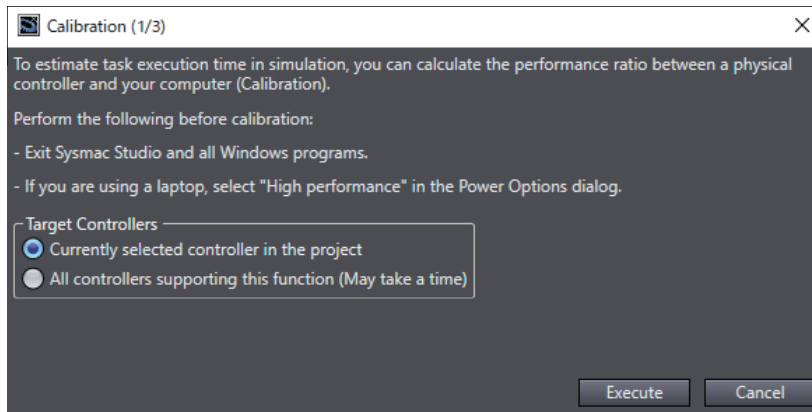

- 2 Exit all running applications, including the Sysmac Studio.
- 3 Select the target Controllers to calibrate, and then click the **Execute** Button. Calibration is started.
If you choose to calibrate all target Controllers, it may take time to complete the calibration.

● Displaying Estimated Task Execution Times

To run the Simulator in Execution Time Estimation Mode, set the following configurations so that they agree with the actual configurations and create the programs to execute.

- EtherCAT axes and slave configuration
- CPU Unit and Unit configuration



Additional Information

Exit all applications that are running on the computer except for the Sysmac Studio. Applications other than the Sysmac Studio may affect the accuracy of estimates.

Procedure

- 1 Select **Run in Execution Time Estimation Mode** from the **Simulation** Menu. The Simulation Pane is displayed and simulation is started in the Execute Time Estimation Mode.

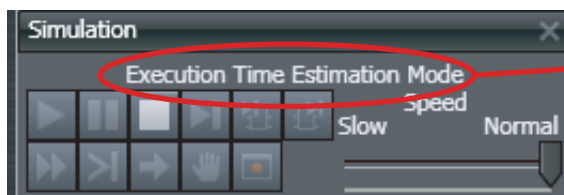

The Execution Time Estimation Mode is displayed.

If the Unit has a hardware revision, a dialog box is displayed to select the hardware revision. Select the hardware revision of the CPU Unit you will use.

- 2 Double-click **Task Settings** under **Configurations and Setup** in the Multiview Explorer. The **Task Settings** Tab Page is displayed in the Edit Pane.
- 3 Click the **Task Execution Time Monitor** Button ()

The Task Execution Time Monitor is displayed.

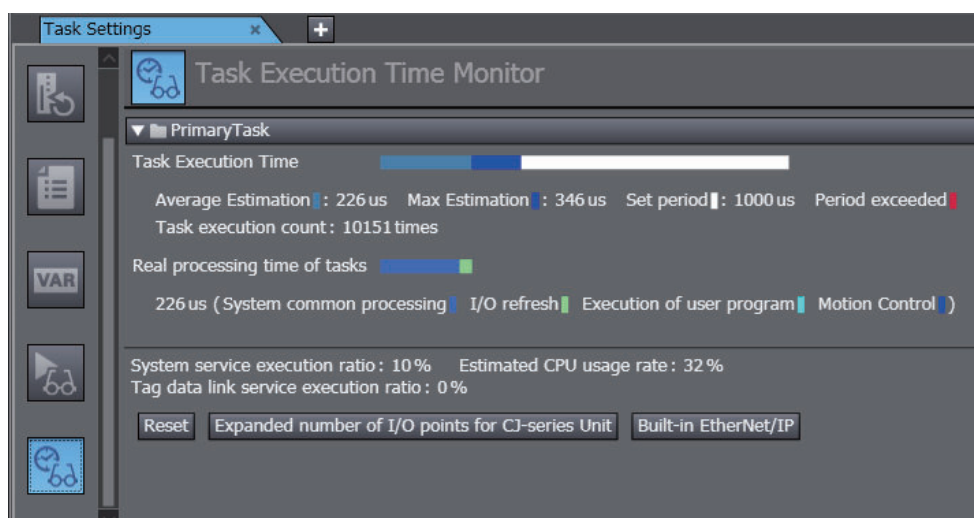

The Task Execution Time Monitor contains the following items.

Item	Description
Task Execution Time	<ul style="list-style-type: none"> • Average and Maximum: The estimated, average and maximum execution times for each task are displayed from when execution of the primary periodic task was started. • Set Period: The task period that is set in the Task Setup is displayed. • Task Execution Count: The number of times the task is executed is displayed.
Real Processing Times of Tasks	The I/O refreshing time, system common processing times, user program execution time, motion control processing time, and the total of all those times are displayed.
System service execution ratio*1	The system service execution time ratio that is set in the System Service Monitoring Settings of the Controller Setup is displayed.
Tag data link service execution ratio*1*2	The predicted value of the percentage of the tag data link execution time in the task execution time is displayed.
Estimated CPU usage rate*1	<p>The percentage of the total of the following times in the task period is displayed.</p> <ul style="list-style-type: none"> • Estimated maximum value of the task processing time • Required system service processing time (for system service monitoring) • Tag data link service execution time <p>If 100% is exceeded for the total of these values, it means that there is not sufficient time for the task processing time, the system service monitoring settings, and the tag data link service execution time.</p>
Resetting Execution Times	Click the Reset Button. The average and maximum task execution times and the real processing times of the tasks are initialized and estimated again.
Expanded number of I/O points for CJ-series Unit*1	Enter the total number of input and output words for CJ-series Units.
Built-in EtherNet/IP*1*2	Set the parameters for calculating the predicted value of the tag data link execution time.

*1. This is displayed only for an NJ-series Controller.

*2. A CPU Unit with unit version 1.03 or later and Sysmac Studio version 1.04 or higher are required to use this function.

- 4 If you are using a CJ-series Unit with an NJ-series Controller, click the **Expanded number of I/O points for CJ-series Unit** Button.

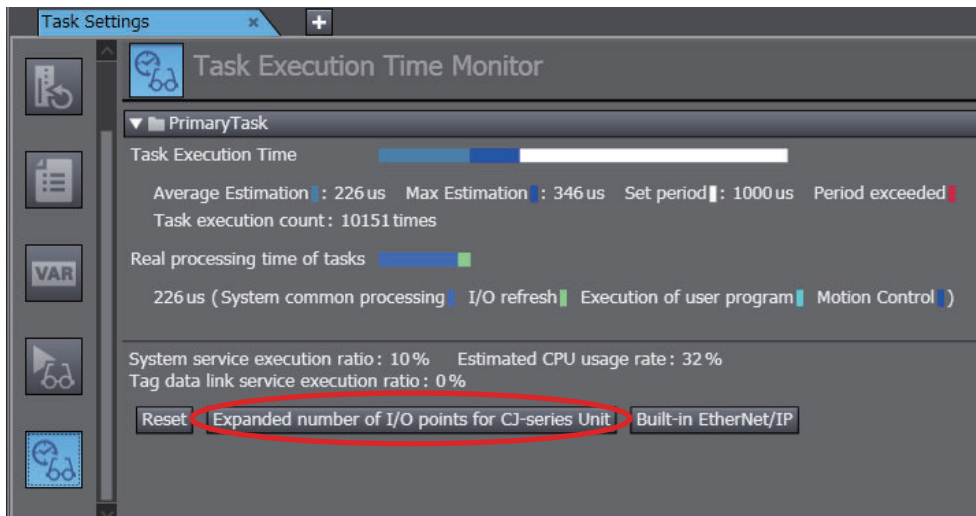

The **Expanded Number of I/O Points for CJ-series Unit** Dialog Box is displayed.

- 5 Create the user-defined variables for the specified CJ-series Special Units, enter the total size of the expansion area for AT specifications (e.g., fixed I/O allocations for DeviceNet Units), and then click the **OK** Button.

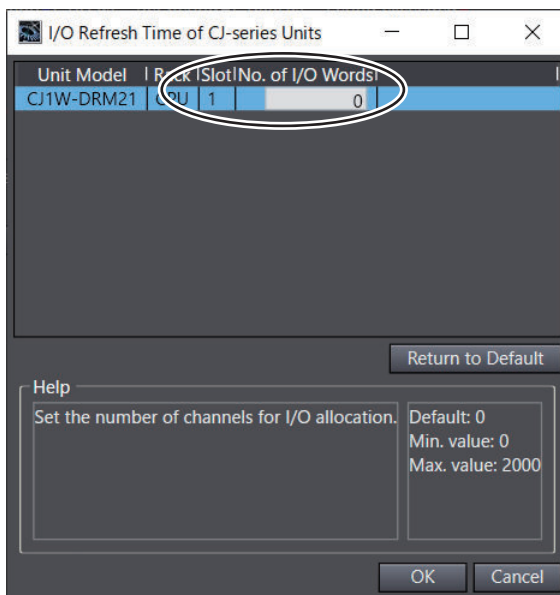

The size of the expansion areas is used to calculate the I/O refresh time for the specific CJ-series Special Units.

- 6 If you are using tag data links, click the **Built-in EtherNet/IP** Button. The Tag Data Link Settings Dialog Box is displayed.

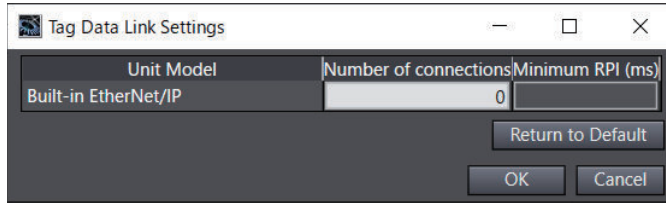

Edit the parameters for the tag data links, and then click the **OK** Button.

The parameters that you set are used to calculate the tag data link service execution time.

If you are using a CJ-series EtherNet/IP Unit, click the **Expanded number of I/O points for CJ-series Unit** Button and make the settings for the tag data links.

Refer to the *NJ/NX-series CPU Unit Software User's Manual (Cat. No. W501)* for information on the parameters.

- 7** Make sure that the task execution times do not exceed the task execution processing times (i.e., the task periods).

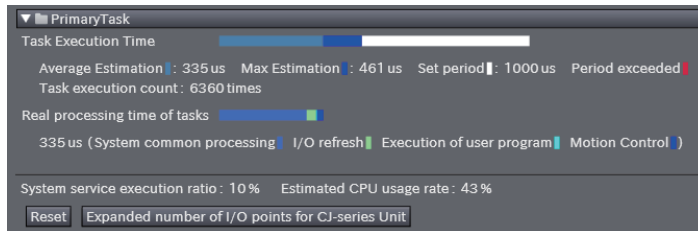

- **Estimating the Task Execution Time of the Priority-5 Periodic Task of an NX701 Controller**

To estimate the task execution time for the priority-5 periodic task of an NX701 Controller, use the transmission delay times of the EtherCAT master that are displayed on the Sysmac Studio. For information on how to calculate the estimated task execution times on paper, refer to the *NJ/NX-series CPU Unit Software User's Manual (Cat. No. W501)*.

This section describes how to display the transmission delay times of the EtherCAT master.

- 1** Right-click the master or a slave and select **Calculate Transmission Delay Time of the Master** in the EtherCAT Tab Page.

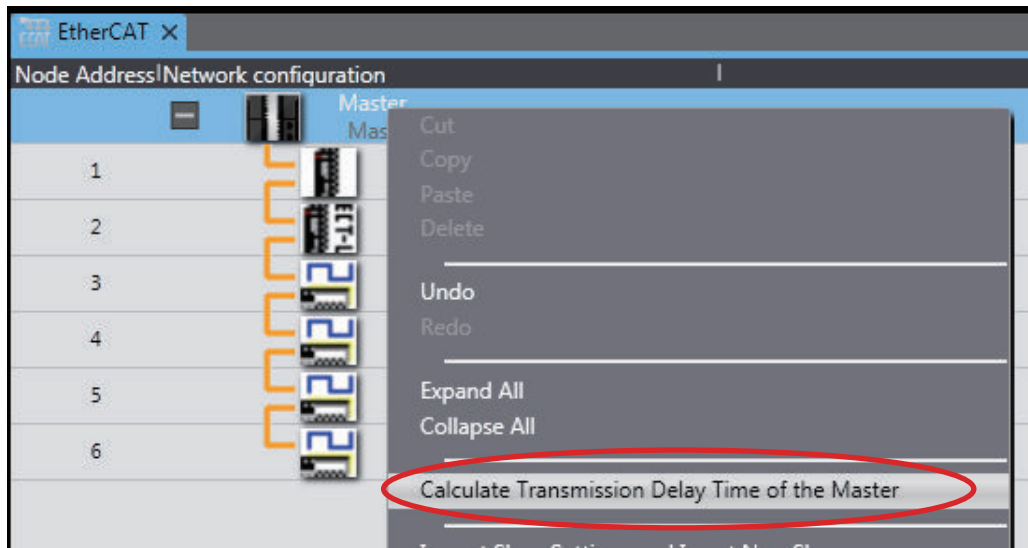

- 2 The transmission delay times of PDO communications cycle 1 and PDO communications cycle 2 are displayed in the Output Tab Page.

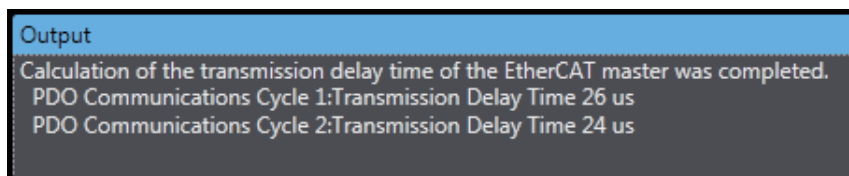

Additional Information

You cannot select this menu command if there is an error in the EtherCAT configurations and setup.

Changing the Simulation Speed

● Changing the Simulation Speed

When debugging, you may want to run the Simulator at a slower speed than normal. To do this, drag the *Simulation Speed Slider* in the Simulation Pane. You can change the simulation speed from 0.1x to 1x. You can change simulation speed while a simulation is in progress or when it is stopped.

● Procedure

- 1 Drag the *Simulation Speed Slider* in the Simulation Pane.

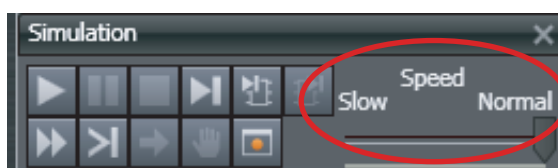

The simulation speed on the computer will change between 0.1x and 1x.

Setting Breakpoints

● Setting Breakpoints

You can set breakpoints to stop execution of a simulation, e.g., to see the status after a specific program is executed.

● Procedure

There are three ways to set breakpoints.

- Right-click an element in a ladder diagram rung or a specific line of ST code, and select **Breakpoints - Set/Clear Breakpoint**. A breakpoint is added at the specified position in the program.
- Select a ladder diagram element or line of ST code and select **Simulation - Set/Clear Breakpoint** from the Main Menu.
- Select a ladder diagram element or line of ST code and click the **Set/Clear Breakpoint** Button in the Simulation Pane.

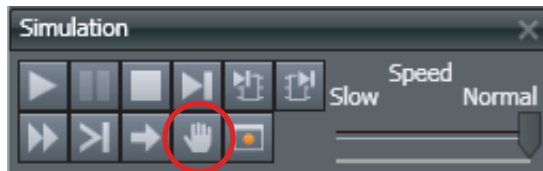

Use the following procedure to set a breakpoint in the ST Editor.

- 1** Click the **Run** Button in the Simulation Pane.
- 2** Place your cursor on the line number of the line where you want to set a breakpoint in the ST Editor.
- 3** Select **Set/Clear Breakpoint** from the **Simulation** Menu.

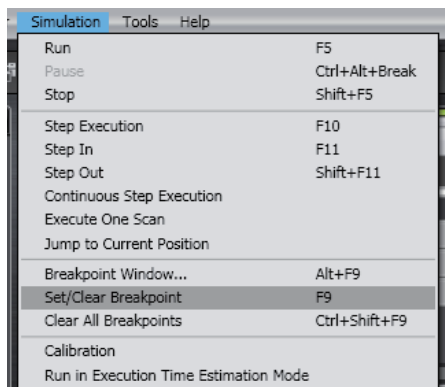

A breakpoint is set on the line designated by the cursor in the ST Editor, as shown below. The program stops at the breakpoints you set.

```

1  varA := 13;
2  varB := 49;
3  IF varA < DINT#1 THEN
4    varA := DINT#100;
5  END_IF;
6  IF varA > DINT#12 THEN
7    varA := DINT#200;
8  END_IF;
9  FOR varB := 0 TO 2 BY 1 DO
10   varA := varB;
11 END_FOR;

```





Enabling/Disabling Breakpoints

You can disable breakpoints while maintaining their set positions and enable them back again. The program continues to run without stopping even if it reaches disabled breakpoints during simulation.

You can enable or disable breakpoints in the Ladder Editor or ST Editor.

● Procedure to Enable or Disable a Breakpoint

- 1 Right-click an element in a ladder diagram rung or a specific line of ST code where a breakpoint is set, and select **Breakpoints - Enable/Disable Breakpoint** from the pop-up menu. The breakpoint is disabled and the breakpoint icon changes to the disabled status.

Icon	Enabled	Disabled
Breakpoint		
Conditional breakpoint		

To enable the breakpoint again, select **Enable/Disable Breakpoint** from the pop-up menu again.



Additional Information

You can also use the following method to enable or disable breakpoints.

- Select **Enable/Disable Breakpoint** from the **Simulation Menu**.
- Press the Ctrl + F9 Keys.

Step Execution

● Step Execution

You can execute a program one line at a time in the ST Editor or one instruction at a time in a ladder diagram.

- 1 When offline or when you execute a program through the Simulator, click the **Step Execution** Button in the Simulation Pane when the program is stopped or when it is paused at a breakpoint.

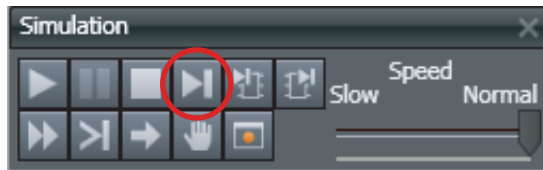

The cursor moves to the next execution step in the ST Editor.

```

1  aaa:=WORD#16#FFFF;
2  IF aaa = bbb THEN (*if aaa = bbb, ccc = true*)
3      ccc := TRUE;
4  END_IF;
5  //End of program1.

```

- 2 Select **Watch Tab Page** from the **View** Menu. The Watch Tab Page is displayed so that you can check for changes in the value of variables.



Additional Information

The position where the program is paused is highlighted in yellow.

Continuous Step Execution

Use the following procedure to perform continuous step execution.

When offline or when you execute a program through the Simulator, click the **Continuous Step Execution Button** in the **Simulation Pane** when the program is stopped at a breakpoint, paused, or stopped during step execution.

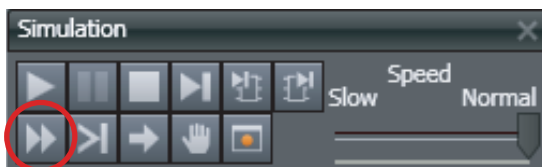

The cursor moves to the next execution step in the ST Editor after a fixed period of time (1 second). The time required to move to the next step depends on the program.

Pausing

Use the following procedure to pause simulations.

Click the **Pause Button** in the **Simulation Pane** when a simulation is in progress.

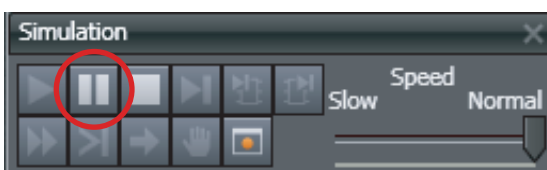

The cursor stops moving. Execution of the program is paused, but the Simulator does not close.

Step In Execution

Use the following procedure to perform step execution of source code inside a function or function block.

When you execute a program through the Simulator, click the **Step In Button** in the **Simulation Pane** when the program is at a function or function block instance when execution is stopped for a breakpoint, paused, or stopped during step execution.

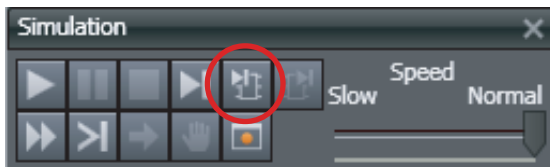

Step Out Execution

Use the following procedure to leave a function or function block currently in Step In Execution.

Click the **Step Out Button** in the **Simulation Pane** when the simulation is stopped in a function block currently in step in execution.

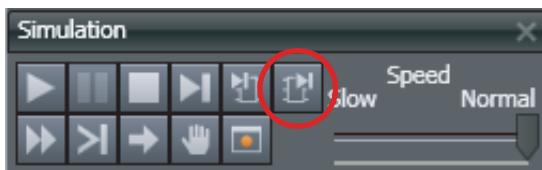

One-period Execution

Use the following procedure to execute the current task for one period. This function pauses execution at the start of the program in the next period.

When offline or when you execute a program through the Simulator, click the **Execute One Scan Button** in the **Simulation Pane** when the program is stopped at a breakpoint, paused, or stopped during step execution.



Setting Conditional Breakpoints

Conditional breakpoints allow you to set conditional expressions at breakpoints that are set in a program.

- 1 Click the **Breakpoint Window** Button in the Simulation Pane.



The Breakpoint Window is displayed with a list of the breakpoints that you have already set.

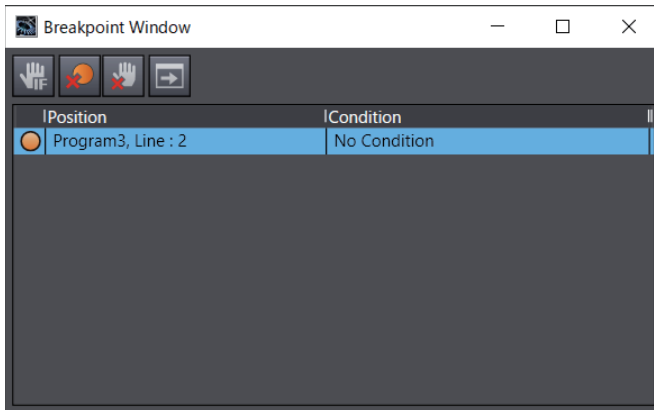

- 2 Select a breakpoint. Click the **Set Conditional Breakpoint** Button.

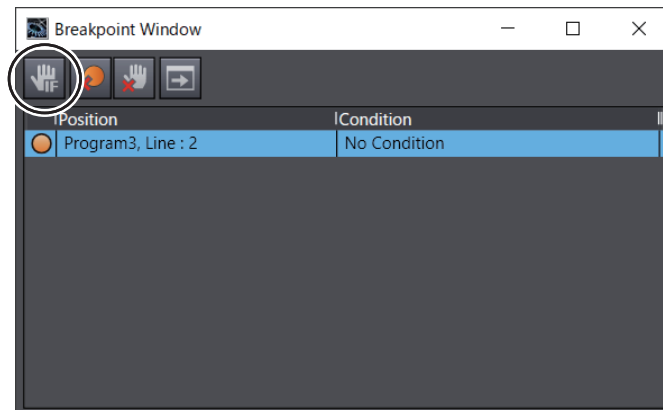

The following dialog box for editing is displayed.

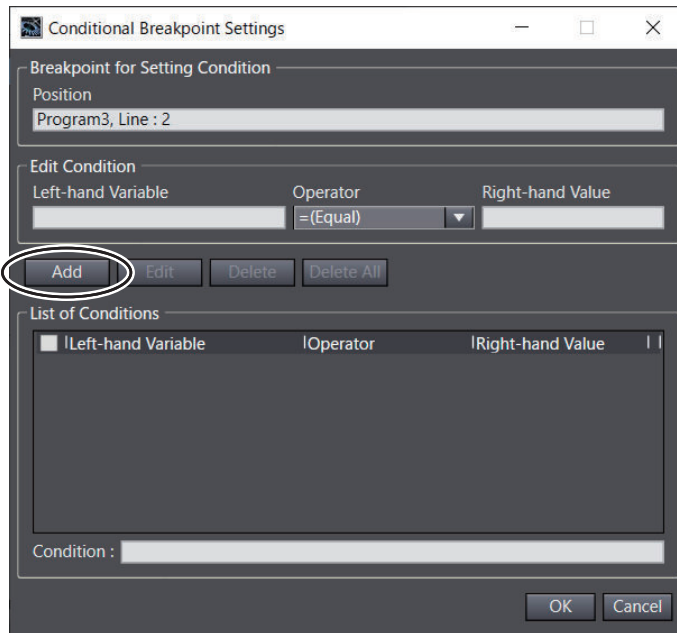

- 3** In the *Edit Condition* Area, enter the condition for breaking, and then click the **Add** Button. For this example, here we have entered a conditional expression of VarA = 13. (VarA is the variable name.)

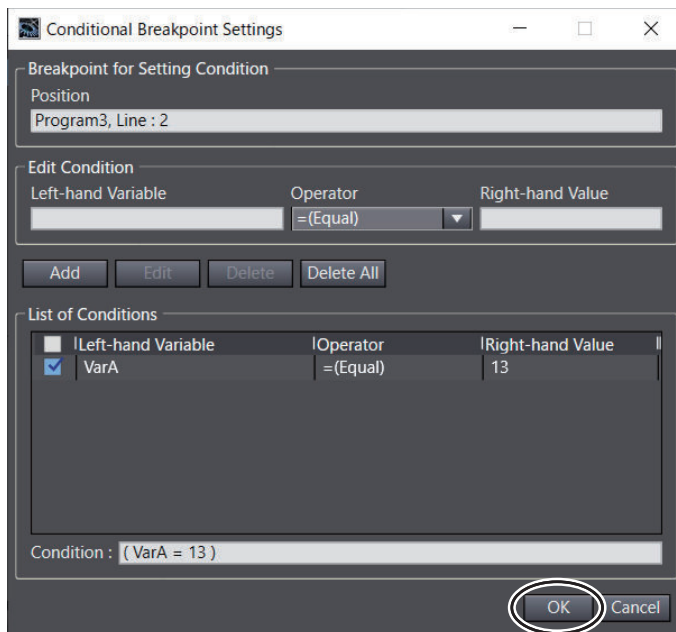

- 4** Check to confirm that your conditional expression was added under *List of Conditions*, and then click the **OK** Button.
- 5** Click the **Run** Button in the Simulation Pane. Execution pauses at the specified location when any of the specified breakpoint conditions are met.

Batch Transfer of the Present Values of Variables

You can save the values of variables at specific times during simulations in a file, or you can write the values of variables that were saved in a file back to the Simulator. This allows you to write the initial values of variables, e.g., for test applications, before you start a simulation.

The data that is gotten or written includes the retained and non-retained variables in the program for which the simulation is performed.

● Getting the Present Values of Variables

- 1 Click the **Pause** Button in the Simulation Pane. Or, select **Pause** from the **Simulation** Menu.
- 2 Click the **Transfer All Variable Present Values** Button in the Simulation Pane. Or, select **Transfer All Variable Present Values** from the **Simulation** Menu.



The Transfer All Variable Present Values Dialog Box is displayed.

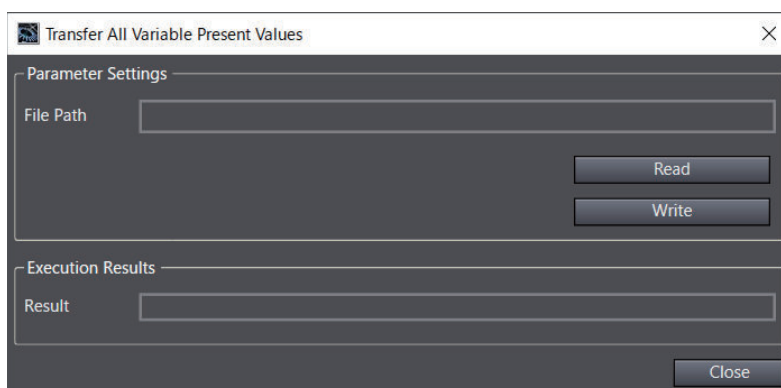

- 3 Click the **Read** Button.
The **Save As** Dialog Box is displayed.
- 4 Enter a file name, and then click the **Save** Button.
A file is created that contains the values of the variables the instant that the **Read** Button was clicked.
- 5 Click the **Close** Button.
The Transfer All Variable Present Values Dialog Box is closed.
Click the **Run** Button in the Simulation Pane. The simulation is started again.

● Writing the Present Values of Variables

- 1 To display the Transfer All Variable Present Values Dialog Box, perform the first two steps in the procedure to get the present variables.
- 2 Click the **Write** Button.
The *Open File* Dialog Box is displayed.
- 3 Select the file that contains the saved variable values, and then click the **Open** Button.
The values of the variables that were saved in the file are written.
If you click the **Run** Button in the Simulation Pane, the simulation is restarted with the written variable values.



Precautions for Correct Use

If any of the variables that are saved in the selected file are different from the variables in the program when the variable values are written, only the values of the variables that are in the program will be written.



Additional Information

- You can use a text editor to edit the file that is saved. This allows you to delete unnecessary variables so that you can write only specific variables.
 - In Sysmac Studio version 1.17 or higher, the following restrictions apply to mutual use of data between the *Backup Variables and Memory* and *Transfer All Variable Present Values* functions.
 - a) Although the *Backup Variables and Memory* function supports the XML and CSV file formats, the *Transfer All Variable Present Values* supports only the CSV file format.
-

7-3-2 Offline Debugging of Sequence and Motion Control Programs

You can visualize the operation of sequence and motion control programs in a Data Trace Tab Page. You use a Data Trace Tab Page for offline debugging when connected to the Simulator. You can use any of the following three formats on the Data Trace Tab Page.

- Time chart graph for each variable
- Path graph for each axis
- 3D machine operation on 3D graph



Precautions for Correct Use

This function is not supported by the Sysmac Studio (64 bit). You cannot create a 3D equipment model.



Additional Information

Sysmac Studio (64 bit) version 1.40 or higher support *3D Simulation* which enables to check operations or motions of 3D equipment models and parts in 3D Visualizer. Refer to the *Sysmac Studio 3D Simulation Function Operation Manual (Cat. No. W618)* for details and the conditions of use on 3D Simulation.

Axis Settings for 3D Equipment Models

You must perform axis settings to link axis variables for motion control to a machine model of a 3D equipment model.

The following is an example of how to set up four axes in a 3D equipment model.

- 1 Add the axes in the **Motion Control Setup**.
Right-click **Axis Settings** under **Configurations and Setup - Motion Control Setup** and select **Add - Axis Settings** from the menu.

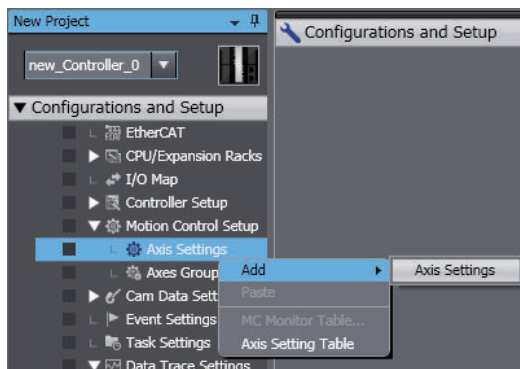

As shown below, a new axis called MC_Axis000 (0) is added.

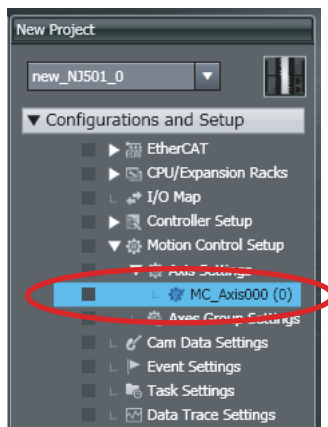

- 2 Perform the same steps three more times to add axes MC_Axis001 (1) to MC_Axis003 (3).

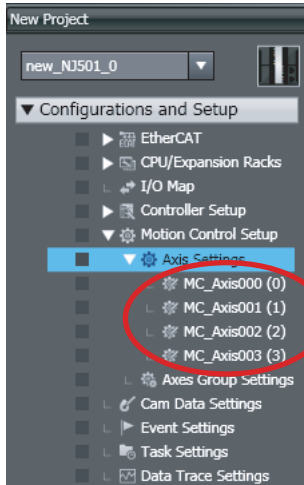

3 Specify the axis settings.

Right-click **Axis Settings** and select **Axis Setting Table** from the menu. Enter the following settings for axes MC_Axis000 (0) to MC_Axis003 (3).

Item	Setting
Axis Use	Used axis
Axis type	Virtual servo or servo axis
Unit	mm

Axis Name	1 MC_Axis000(0)	2 MC_Axis001(1)	3 MC_Axis002(2)	4 MC_Axis003(3)
Axis Basic Settings				
Axis use	Used axis	Used axis	Used axis	Used axis
Axis type	Virtual servo axis	Virtual servo axis	Virtual servo axis	Virtual servo axis
Feedback control	No control loop	No control loop	No control loop	No control loop
Input device				
Channel				
Output device				
Channel				
Unit Conversion Settings				
Unit of display	mm	mm	mm	mm
Command pulse count per motor rotation	10000 pulse/rev	10000 pulse/rev	10000 pulse/rev	10000 pulse/rev
Work travel distance per motor rotation	10000 mm/rev	10000 mm/rev	10000 mm/rev	10000 mm/rev
Operation Settings				
Maximum velocity	40000000 mm/s	40000000 mm/s	40000000 mm/s	40000000 mm/s
Velocity warning value	0 %	0 %	0 %	0 %
Maximum jog velocity	1000000 mm/s	1000000 mm/s	1000000 mm/s	1000000 mm/s
Maximum acceleration	0 mm/s ²	0 mm/s ²	0 mm/s ²	0 mm/s ²
Acceleration warning value	0 %	0 %	0 %	0 %
Maximum deceleration	0 mm/s ²	0 mm/s ²	0 mm/s ²	0 mm/s ²
Deceleration warning value	0 %	0 %	0 %	0 %
Acceleration/deceleration over	Use rapid acceleration/de	Use rapid acceleration/de	Use rapid acceleration/c	Use rapid acceleration/c
Operation selection at Reversing	Deceleration stop	Deceleration stop	Deceleration stop	Deceleration stop
Positive torque warning value	0 %	0 %	0 %	0 %
Negative torque warning value	0 %	0 %	0 %	0 %
In-position range	10 mm	10 mm	10 mm	10 mm
In-position check time	0 msec	0 msec	0 msec	0 msec
Actual velocity filter time constant	0 msec	0 msec	0 msec	0 msec
Zero position range	10 mm	10 mm	10 mm	10 mm
Other Operation Settings				
Immediate stop input stop method	Immediate stop	Immediate stop	Immediate stop	Immediate stop
Limit input stop method	Immediate stop	Immediate stop	Immediate stop	Immediate stop
Drive error reset monitoring time	200 msec	200 msec	200 msec	200 msec
Maximum positive torque limit	300.0 %	300.0 %	300.0 %	300.0 %
Maximum negative torque limit	300.0 %	300.0 %	300.0 %	300.0 %
Limit Settings				
Software limits	Disabled	Disabled	Disabled	Disabled
Positive software limit	2147483647 mm	2147483647 mm	2147483647 mm	2147483647 mm
Negative software limit	-2147483648 mm	-2147483648 mm	-2147483648 mm	-2147483648 mm
Following error over value	0 mm	0 mm	0 mm	0 mm
Following error warning value	0 mm	0 mm	0 mm	0 mm
Homing Settings				
Homing method	Zero position preset	Zero position preset	Zero position preset	Zero position preset
Home input signal	Use Z-phase input as hom	Use Z-phase input as hor	Use Z-phase input as hi	Use Z-phase input as hi
Homing start direction	Positive direction	Positive direction	Positive direction	Positive direction
Operation selection at positive limit input	Reverse turn/immediate s	Reverse turn/immediate i	Reverse turn/immediat	Reverse turn/immediat
Home input detection direction	Positive direction	Positive direction	Positive direction	Positive direction
Operation selection at negative limit input	Reverse turn/immediate s	Reverse turn/immediate i	Reverse turn/immediat	Reverse turn/immediat
Homing velocity	10000 mm/s	10000 mm/s	10000 mm/s	10000 mm/s
Homing approach velocity	1000 mm/s	1000 mm/s	1000 mm/s	1000 mm/s

● Procedure

- 1** Add an axis to the Multiview Explorer and then set the parameters of the axis variable.
Refer to *5-7 Motion Control Setup* on page 5-80 for the setting procedure.
- 2** Create a program to operate the equipment.
Refer to *Section 4 Programming* on page 4-1 for the programming procedures.
- 3** Create the 3D equipment model with a data trace.
Refer to *Creating 3D Equipment Models* on page 7-74 for the procedure to create 3D equipment models.
- 4** Register the trigger setting and variables to trace for the data trace.
Refer to *7-2-11 Data Tracing* on page 7-53 for the operating procedures for data tracing.
- 5** Execute a simulation.
Refer to *Simulation Procedures* on page 7-86 for the execution procedures.
- 6** Start tracing the data with the data trace to sample the data.
- 7** Check the trace results on the Data Trace Tab Page.
- 8** Click the Play Button on the Data Trace Tab Page.
The following move synchronously: the cursor on the trace graph, the 3D machine model, and the cursor in the 2D view.
Refer to *3D Motion Monitor Display Mode* on page 7-67 for the operating procedures for 3D motion monitoring.

7-3-3 Offline Debugging for Sequence Control and Vision Sensor

You can simulate the linked operation of sequence control and a Vision Sensor to debug them offline. Use the following procedure.

1. Add the Vision Sensor to the configuration of EtherCAT slaves.
2. Set up the Vision Sensor.
3. Use the control bits to enter a measurement trigger and confirm the results.

The actual procedure from adding the Vision Sensor to the configuration of EtherCAT slaves to checking the results is given below.

● FQ-M-series Vision Sensors

- 1** Add an **FQ-MS12x-ECT...** Vision Sensor to the configuration of EtherCAT slaves.
Refer to *5-2 EtherCAT Configuration and Setup* on page 5-4 for the procedure to register EtherCAT slaves.

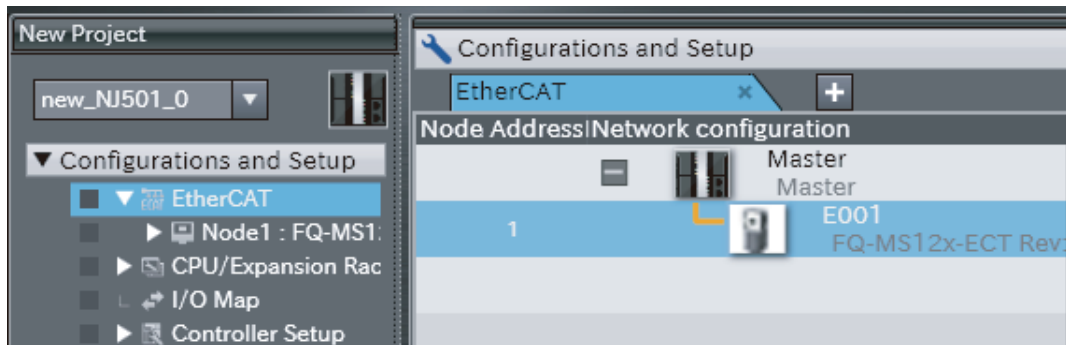

- 2** Set up the Vision Sensor.
Double-click **FQ-MS12x-ECT...** that was added to the Multiview Explorer.

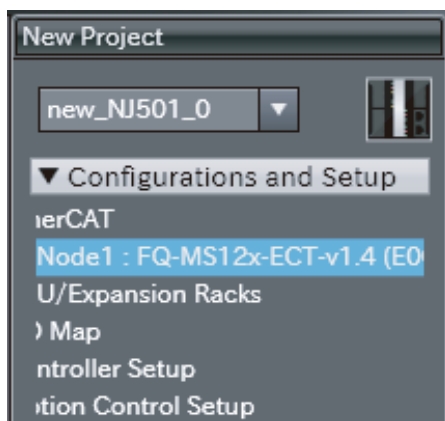

The Setup Tab Page for the **FQ-MS12x-ECT...** is displayed for the Edit Pane. Make all of the required setting. Refer to the *FQ-M-series Specialized Vision Sensor for Positioning User's Manual (Cat. No. Z314)* for the setup procedures.

After you complete setting up the **FQ-MS12x-ECT...**, change to RUN Mode to perform offline debugging. Refer to the *FQ-M-series Specialized Vision Sensor for Positioning User's Manual (Cat. No. Z314)* for the setup procedures.

- 3** Start the monitor.
Right-click the **FQ-MS12x...** in the Multiview Explorer and select **Start Monitoring** from the menu.

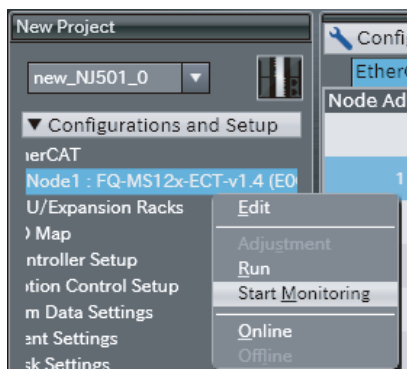

- 4** After the monitor starts, specify the measurement image.
Click the Select Image File Icon, and select the image.



- 5 Select **Run** from the **Simulation** Menu.
The Simulator starts.
- 6 Manipulate the control bits in the sequence controls to execute measurements. The measurement results are displayed in the **Monitoring** Area.

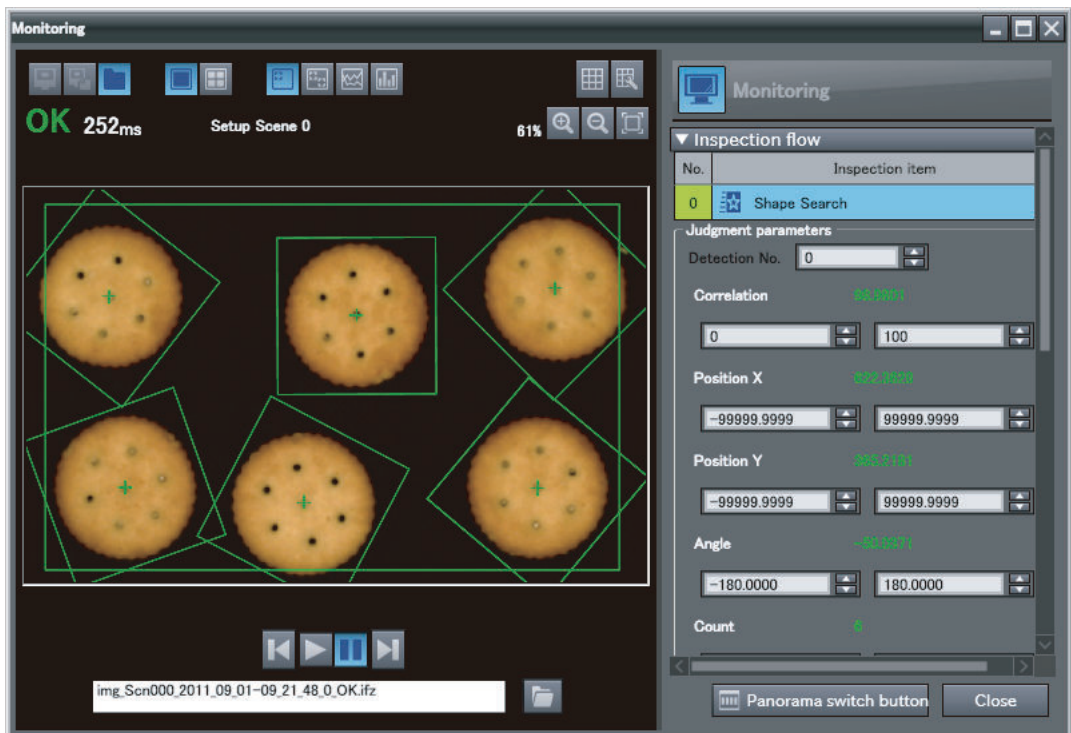

Refer to the *FQ-M-series Specialized Vision Sensor for Positioning User's Manual (Cat. No. Z314)* for the items that you can execute during offline debugging.

● FH-series Vision Sensors

- 1 Add an **FH-XXXX** Vision Sensor to the configuration of EtherCAT slaves.
 - Drag a **FH-XXXX** from the **Toolbox** to the EtherCAT Tab Page.
 - Select the master on the EtherCAT Tab Page, and then double-click **FH-XXXX** in the **Toolbox**.

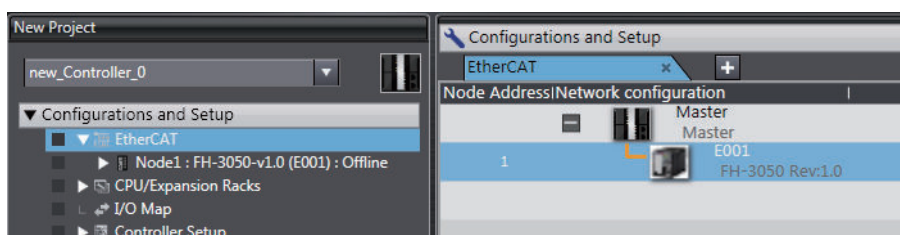

Refer to 5-2 **EtherCAT Configuration and Setup** on page 5-4 for details on the procedure to register EtherCAT slaves.

2 Set up the Vision Sensor.

Double-click **Scene data** or **System data** under **NodeX:FH-XXXX – Line X** in the Multiview Explorer.

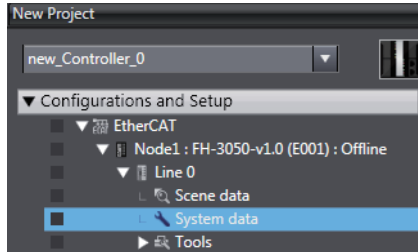

The Setup Tab Page for the scene or system data is displayed in the Edit Pane. Make all of the required settings. Refer to the *Vision System FH/FHV Series Operation Manual for Sysmac Studio (Cat. No. Z343)* for the setup procedures.

3 Write the program to operate the device and build the program.

Refer to *Section 4 Programming* on page 4-1 for the programming procedures.

4 Open the Monitor Window.

Right-click **Line X** under **FH-XXXX** in the Multiview Explorer and select **Monitor window** from the menu.

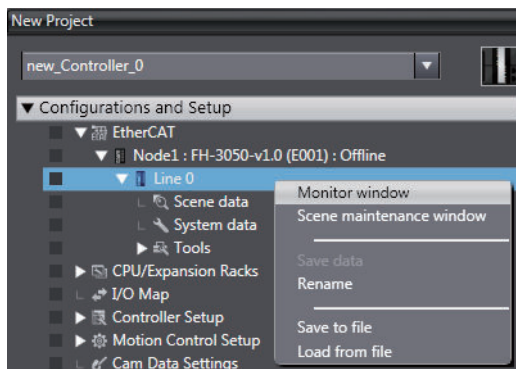

5 Specify the measurement image.

Click the Select Image File Icon, and select the image.



6 Select **Run** from the **Simulation** Menu.

The Simulator starts.

When the Simulator is connected, it creates an internal EtherCAT connection between the NJ/NX/NY-series Controller and FH-series Sensor Controller and the NJ/NX/NY-series Controller enters an Operational state.

Refer to 7-3-1 *Debugging with Program Simulation* on page 7-86 for the procedures to use the Simulator.

- 7** Manipulate the control bits in the sequence controls to execute measurements. The measurement results are displayed in the Monitor Window.

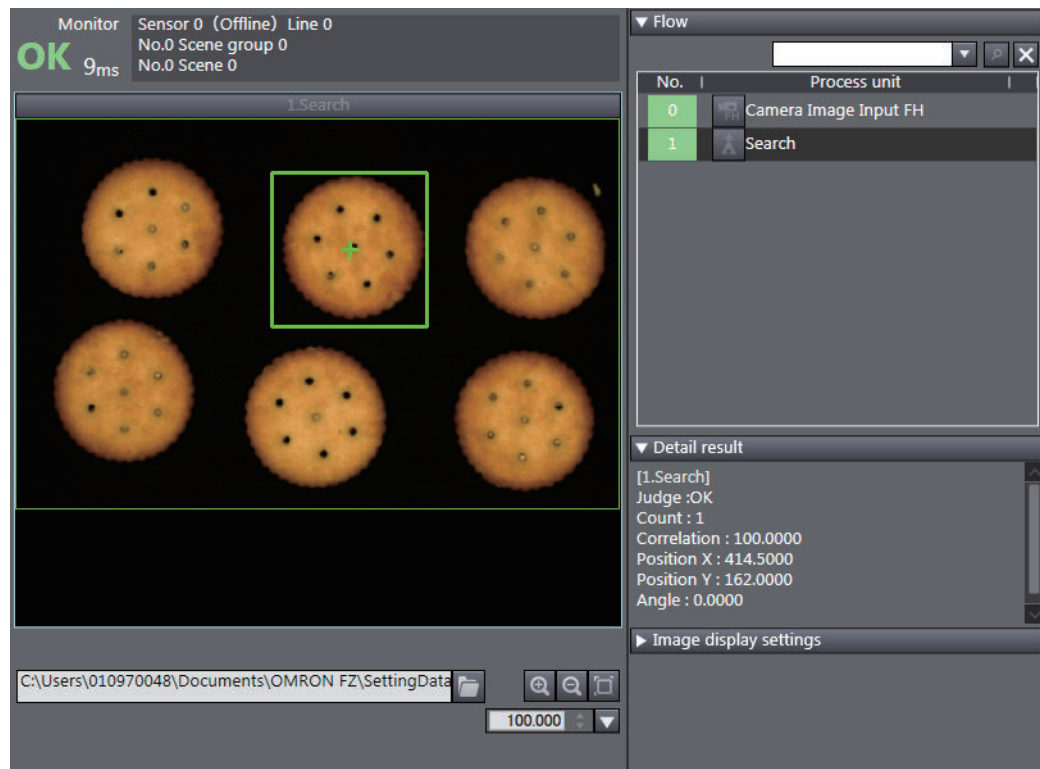

Precautions for Correct Use

You can execute simulations of sensor control programs only for the Vision Sensor that you are currently editing. You cannot perform simulations for more than one FH Vision Sensor at the same time.



Additional Information

If Run Mode in the Response Area (Status Flag: Run Mode) is OFF when you execute a simulation, open the Monitor Window. Run Mode will turn ON when you open the Monitor Window.

7-3-4 Offline Debugging for Sequence Control and Displacement Sensor

You can simulate the linked operation of sequence control and a Displacement Sensor to debug them offline.

Use the following procedure.

- (1) Add the Displacement Sensor to the configuration of EtherCAT slaves.
- (2) Set up the Displacement Sensor.
- (3) Input the control flags as necessary and check the measurement results.

The actual procedure from adding the Displacement Sensor to the configuration of EtherCAT slaves to checking the results is given below.

- 1 Add an **ZW-CE1x** Displacement Sensor to the configuration of EtherCAT slaves.
Refer to 5-2 *EtherCAT Configuration and Setup* on page 5-4 for the procedure to register EtherCAT slaves.
- 2 Set up the Displacement Sensor.
Double-click the **ZW-CE1x** that you added to the EtherCAT Tab Page.
The Setup Tab Page for the **ZW-CE1x** is displayed in the Edit Pane. Make all of the required setting. Refer to the *ZW-series Confocal Fiber Type Displacement Sensor User's Manual (Cat. No. Z332)* for the setup procedures.

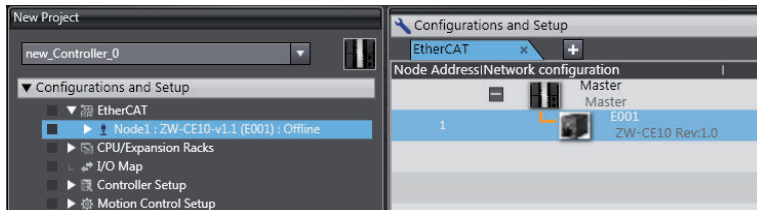

- 3 Set up the simulation data.
When you execute the simulation, specify the file in which to store the measurement values that are output by the ZW Displacement Sensor. Refer to the *ZW-series Confocal Fiber Type Displacement Sensor User's Manual (Cat. No. Z332)* for the setup procedures.
If the file is not specified, "0 mm" is output as the task measurement values during simulation.

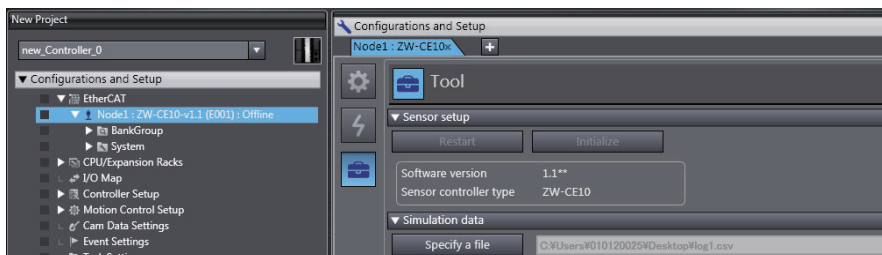

The following format must be used.

File format: CSV

Data format: As shown below (Data for up to 120,000 indices can be read.)

Index,	Task1	Task2,	Task3,	Task4
0,	0.12345,	0.213,	0,	0,
1,	0.12345,	0.213,	0,	0,
2,	0.12345,	0.213,	0,	0,
3,	0.12345,	0.213,	0,	0,
119999,	0.12345,	0.213,	0,	0,

The data for one index is output to the file for each simulation cycle. When all of the data has been output, the data is output again from the beginning.

- 4 Select **Run** from the **Simulation** Menu.
The Simulator starts.

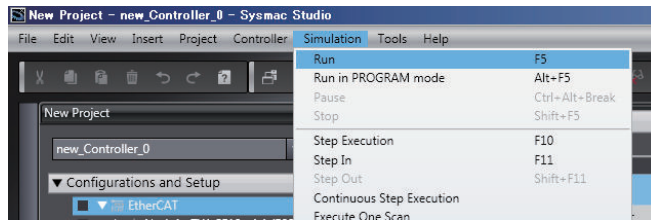

5 Check the I/O Map.

Double-click **I/O Map** on the Multiview Explorer. The **I/O Map** is displayed in the Edit Pane. The simulation data is updated on the display. Check to see if the program operates as intended.



Additional Information

This simulation can be used to check the behaviour of ZW control signals. Measurement processing for the control signals is not simulated. (This includes zero reset processing for the zero reset signal and hold processing for timing signals.)

7-3-5 Offline Debugging with Sequence Control and NA-series PT Simulator (Simultaneous Simulation of Controller with NA-series PT)

You can simulate the linked operation of sequence controls and an NA-series PT to perform offline debugging for the sequence program and NA-series PT application at the same time. Select an NA-series PT in the same project and perform the following procedure.

1 Select **Run with NA Simulator** from the Simulation Menu.

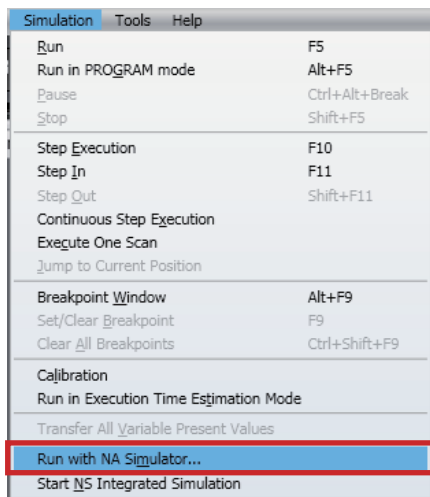

A dialog box to select the NA-series PT is displayed.

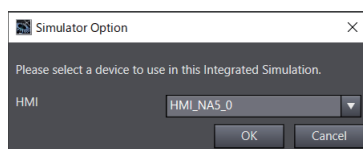

2 Select the NA-series PT for which to perform the simulation and click the **OK** Button.

The simulators for the Controller and NA-series PT will start.



The Simulation Pane has a button that is used dedicatedly for simultaneous simulation of the Controller with an NA-series PT. Refer to *Dedicated Window for Simultaneous Simulation with NA-series PT* on page 7-116 for information on this pane.

Refer to the *NA-series Programmable Terminal Software User's Manual (Cat. No. V118)* for the features of an NA-series PT that you can use in simultaneous simulation with the NA-series PT Simulator.

- 3 To stop simultaneous simulation with the NA-series PT Simulator, click the **Stop** Button in the Simulation Pane.
The NA-series PT Simulator is ended and simultaneous simulation with the NA-series PT Simulator is ended.
To execute simultaneous simulation with the NA-series PT Simulator again, select **Run with NA Simulator** from the Simulation Menu.

Dedicated Window for Simultaneous Simulation with NA-series PT

When you perform simultaneous simulation with an NA-series PT, the following dedicated window is displayed. In this window, you can perform offline debugging for the Controller and an NA-series PT at the same time.

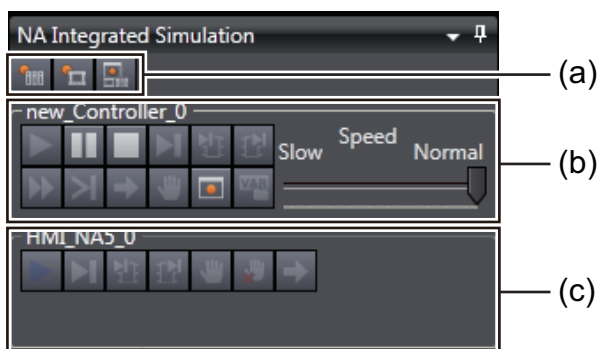

	Item	Description
(a)	Enable/Disable All Controller Breakpoints Button	Use this button to enable or disable all breakpoints that are set for the Controller at once.
	Enable/Disable All HMI Breakpoints Button	Use this button to enable or disable all breakpoints that are set for the NA-series PT at once.
	NA Integrated Simulation Breakpoint Window Button	Use this button to display the dedicated breakpoint window for simultaneous simulation with an NA-series PT. Refer to <i>NA Integrated Simulation Breakpoint Window</i> on page 7-117 for details.
(b)	Simulation buttons for Controllers	These buttons are the same as those in the Simulation Pane for Controllers. Refer to the descriptions of the simulation buttons in <i>Simulation Procedures</i> on page 7-86.
(c)	Simulation buttons for NA-series PTs	These buttons are the same as those in the Simulation Pane NA-series PTs. Refer to the <i>NA-series Programmable Terminal Software User's Manual (Cat. No. V118)</i> for details.

● NA Integrated Simulation Breakpoint Window

When you perform simultaneous simulation with an NA-series PT, the following dedicated breakpoint window is displayed. In this window, you can display the breakpoints for the Controller and an NA-series PT at the same time to perform condition setting.

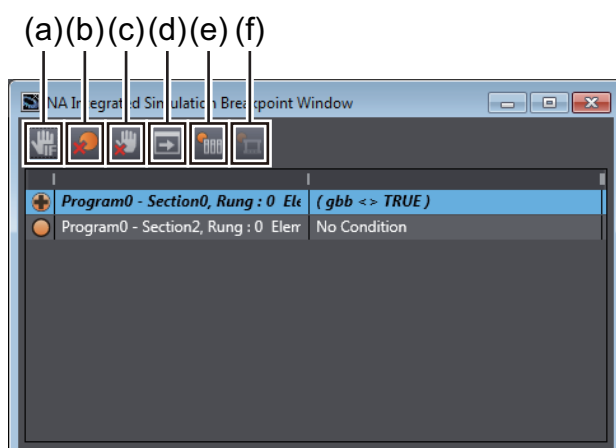

	Button name	Description
(a)	Set Conditional Breakpoint	The Set Conditional Breakpoint Dialog Box is displayed. Refer to <i>Setting Conditional Breakpoints</i> on page 7-102 for the condition setting procedure.
(b)	Clear Breakpoint	Use this button to clear the selected breakpoint.
(c)	Delete All Breakpoints	Use this button to delete all breakpoints for the Controller or NA-series PT.
(d)	Jump to Source Code	Use this button to display the location in the Editor where the selected breakpoint is set.
(e)	Enable/Disable All Controller Breakpoints	Use this button to enable or disable all breakpoints that are set for the Controller at once.
(f)	Enable/Disable All HMI Breakpoints	Use this button to enable or disable all breakpoints that are set for the NA-series PT at once.

7-3-6 Integrated NS-series PT Simulation for Offline Debugging of Sequence Control and NS-series PTs

You can simulate the linked operation of a sequence program and an NS-series Programmable Terminal to debug the sequence program and screen data offline.

This is done by using the screen data that was created for the NS-series PT with the CX-Designer Support Software with the following procedure.

Refer to the *CX-Designer User's Manual (Cat. No. V099)* for the procedures to create screen data for the NS-series PT.

- 1 Select **Start NS Integrated Simulation** from the Simulation Menu.

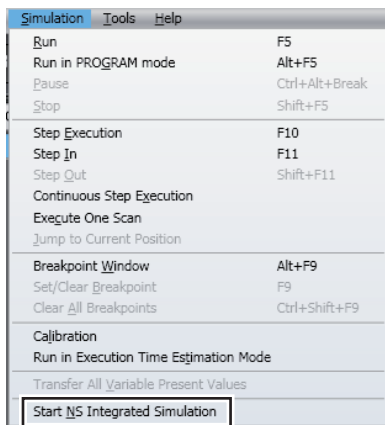

If the CX-Designer is not running, the Start NS Integrated Simulation Dialog Box is displayed.

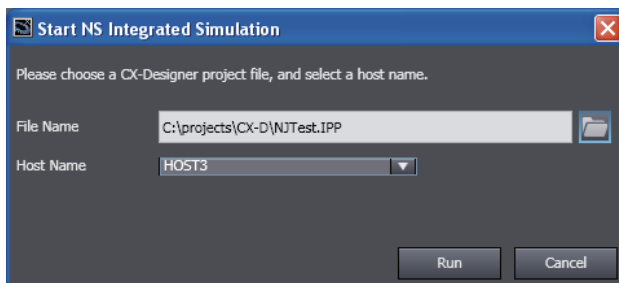

- 2 Click the Browse Button  and select the CX-Designer project file to use in the integrated NS-series PT simulation.
Then select the *host name* that was set in the CX-Designer Communications Setup Dialog Box from the **Host Name** Box.
Refer to the *CX-Designer User's Manual (Cat. No. V099)* for the procedures to create a CX-Designer project file and for information on setting host names.
- 3 Click the **Run** Button.
The Simulator starts and the program that was built for the Simulator is downloaded.
Then the CX-Designer is started and the Test Screen is displayed.

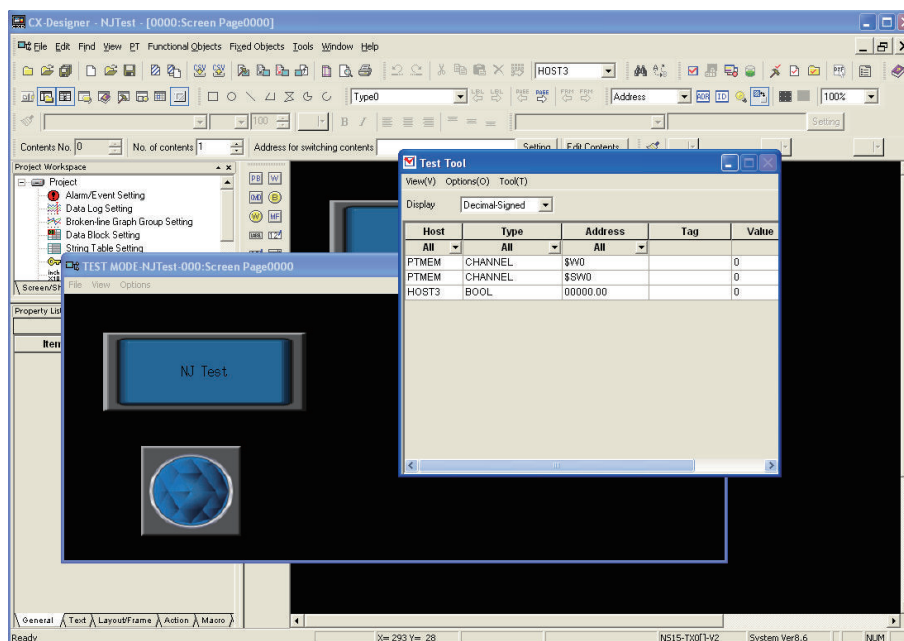

Refer to the *CX-Designer User's Manual (Cat. No. V099)* for information on the capabilities of integrated NS-series PT simulation.

- 4** To stop the integrated NS-series PT simulation, click the **Stop** Button in the Simulation Pane. The integrated NS-series PT simulation stops.
- To restart the integrated NS-series PT simulation, click the **Run** Button in the Simulation Pane, or select **Start NS Integrated Simulation** from the Simulation Menu.



Precautions for Correct Use

The NJ-series Controller must be registered as the host type in the CX-Designer project file that is used for integrated NS-series PT simulation.



Additional Information

- If the CX-Designer is already running when the integrated NS-series PT simulation is started, the project that is currently open in the CX-Designer will be used in the integrated NS-series PT simulation.

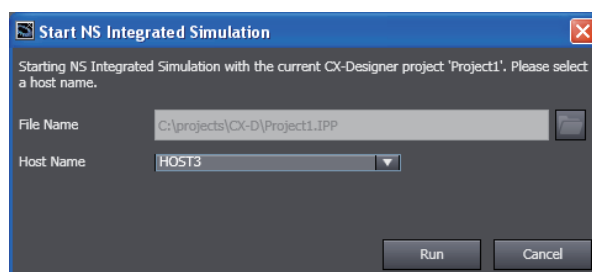

Execution is not possible if the CX-Designer is already running in more than one window. Start the CX-Designer only for the project for which you will execute the integrated NS-series PT simulation.

7-3-7 Offline Debugging for Sequence Control and Safety CPU Units

You can simulate the linked operation of sequence control and an Safety CPU Unit to perform offline debugging for the sequence program and safety program at the same time.

● Operation Procedure

- 1 Open a project that includes a Controller and a Safety CPU Unit.
- 2 Select **Safety Integrated Simulation** from the Simulation Menu.

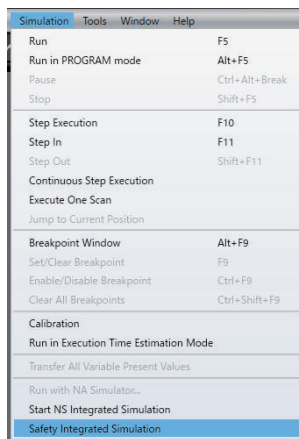

When a safety integration simulation is in progress, the device list in the MultiView Explorer displays only the Controller and Safety CPU Unit being simulated. Perform offline debugging by switching the device as needed.

● Exit Procedure

To exit the safety integrated simulation, click the **Stop** Button in the **Simulation Pane** or the **Safety Simulation Pane**.



Precautions for Correct Use

When a safety integrated simulation is in progress, the device variable values registered in the I/O Map of the Controller and the exposed variable values of the Safety CPU Unit are linked. If the initial values of variables are set, or if the values of device variables are written using a debug program, etc., the device variable values may be updated, resulting in incorrect operation.

7-3-8 3D Simulation

Sysmac Studio (64 bit) version 1.40 or higher provides the *3D Simulation function* for checking operations or motions of 3D equipment models and parts on 3D Visualizer. To use the Sysmac Studio 3D simulation, you need to additionally purchase a license of *Sysmac Studio 3D Simulation Option*. Refer to the *Sysmac Studio 3D Simulation Function Operation Manual (Cat. No. W618)* for details on the 3D simulation.

7-3-9 Executing OPC UA Server on the Simulator

You can execute the OPC UA Server function on the Sysmac Studio Simulator in Sysmac Studio version 1.62 or higher.

Refer to the *NJ/NX-series CPU Unit OPC UA User's Manual (Cat. No. W588)* for details on the OPC UA Server function for the Simulator.

7-4 Preparations for Online Debugging

● Preparing for Online Debugging

The Sysmac Studio and NJ/NX/NY-series Controllers separate the variables that you use in the programs from the I/O information for external devices. Therefore, it is necessary to define the connection between variables and I/O information.

7-4-1 Assigning Variables and Real I/O

● Assigning Variables and Real I/O

"Defining the connection between logic and physical devices" means to define the connection between the variables used in the programs and the actual I/O information of the physical devices. Specifically, this involves assigning global variables and I/O ports.

● Procedure to Start Assigning Variables and Real I/O

- 1 Double-click **I/O Map** under **Configurations and Setup** on the Multiview Explorer.

Pos	Port	Description	R/W	Data Type	Value	Variable
0	Ch1_Out0	Output CH1 bit 00	RW	BOOL	FALSE	
	Ch1_Out01	Output CH1 bit 01	RW	BOOL	FALSE	
	Ch1_Out02	Output CH1 bit 02	RW	BOOL	FALSE	
	Ch1_Out03	Output CH1 bit 03	RW	BOOL	FALSE	
	Ch1_Out04	Output CH1 bit 04	RW	BOOL	FALSE	
	Ch1_Out05	Output CH1 bit 05	RW	BOOL	FALSE	
	Ch1_Out06	Output CH1 bit 06	RW	BOOL	FALSE	
	Ch1_Out07	Output CH1 bit 07	RW	BOOL	FALSE	
	Ch1_Out08	Output CH1 bit 08	RW	BOOL	FALSE	
	Ch1_Out09	Output CH1 bit 09	RW	BOOL	FALSE	
	Ch1_Out10	Output CH1 bit 10	RW	BOOL	FALSE	
	Ch1_Out11	Output CH1 bit 11	RW	BOOL	FALSE	
	Ch1_Out12	Output CH1 bit 12	RW	BOOL	FALSE	
	Ch1_Out13	Output CH1 bit 13	RW	BOOL	FALSE	
	Ch1_Out14	Output CH1 bit 14	RW	BOOL	FALSE	
	Ch1_Out15	Output CH1 bit 15	RW	BOOL	FALSE	
	Ch2_Out0	Output CH2 bit 00	RW	WORD	16#0	
	Ch2_Out01	Output CH2 bit 01	RW	BOOL	FALSE	
	Ch2_Out02	Output CH2 bit 02	RW	BOOL	FALSE	
	Ch2_Out03	Output CH2 bit 03	RW	BOOL	FALSE	
	Ch2_Out04	Output CH2 bit 04	RW	BOOL	FALSE	
	Ch2_Out05	Output CH2 bit 05	RW	BOOL	FALSE	
	Ch2_Out06	Output CH2 bit 06	RW	BOOL	FALSE	
	Ch2_Out07	Output CH2 bit 07	RW	BOOL	FALSE	
	Ch2_Out08	Output CH2 bit 08	RW	BOOL	FALSE	
	Ch2_Out09	Output CH2 bit 09	RW	BOOL	FALSE	
	Ch2_Out10	Output CH2 bit 10	RW	BOOL	FALSE	



Precautions for Correct Use

To perform this operation, the Units in the actual configuration must already be registered under **Controller Configurations and Setup – CPU/Expansion Racks**.

● Procedure to Assign Variables and Real I/O

Use the following procedure to assign a variable in the **Variable** Column to the I/O device in the **Port** Column.

- 1 Click cell for the I/O device in the **Variable** Column. Or, move the cursor to the cell and press the F2 Key.
This places you in Edit Mode and displays a list of the global variables.

Pos	Port	Description	R/W	Data Typ	Variable	Variable Comment	Variable Type
	CF	▼ CPU/Expansion Racks					
	CF	▼ CPU Rack 0					
[0]	▼ CI1W-OD232 (Transistor Output)						
	▼ Ch1_Out						
	Ch1_Out00	Output CH1	RW	WORD			
	Ch1_Out01	Output CH1 bit 01	RW	BOOL	Out_00		
	Ch1_Out02	Output CH1 bit 02	RW	BOOL	Out_01		
	Ch1_Out03	Output CH1 bit 03	RW	BOOL	Out_02		
	Ch1_Out04	Output CH1 bit 04	RW	BOOL	Out_03		
	Ch1_Out05	Output CH1 bit 05	RW	BOOL			
	Ch1_Out06	Output CH1 bit 06	RW	BOOL			
	Ch1_Out07	Output CH1 bit 07	RW	BOOL			
	Ch1_Out08	Output CH1 bit 08	RW	BOOL			
	Ch1_Out09	Output CH1 bit 09	RW	BOOL			
	Ch1_Out10	Output CH1 bit 10	RW	BOOL			
	Ch1_Out11	Output CH1 bit 11	RW	BOOL			
	Ch1_Out12	Output CH1 bit 12	RW	BOOL			
	Ch1_Out13	Output CH1 bit 13	RW	BOOL			
	Ch1_Out14	Output CH1 bit 14	RW	BOOL			

- 2** Select a global variable from the list. (Click the global variable or move your cursor to the variable you want to select and press the Enter Key.) The specified variable is displayed as shown below.

You can also enter a variable directly. The list will be narrowed based on the text you enter so that you can more easily find the variable you need.

Pos	Port	Description	R/W	Data Typ	Variable	Variable Comment	Variable Type
	CF	▼ CPU/Expansion Racks					
	CF	▼ CPU Rack 0					
[0]	▼ CI1W-OD232 (Transistor Output)						
	▼ Ch1_Out						
	Ch1_Out00	Output CH1	RW	WORD	Out_00		
	Ch1_Out01	Output CH1 bit 01	RW	BOOL			
	Ch1_Out02	Output CH1 bit 02	RW	BOOL			
	Ch1_Out03	Output CH1 bit 03	RW	BOOL			
	Ch1_Out04	Output CH1 bit 04	RW	BOOL			
	Ch1_Out05	Output CH1 bit 05	RW	BOOL			
	Ch1_Out06	Output CH1 bit 06	RW	BOOL			
	Ch1_Out07	Output CH1 bit 07	RW	BOOL			
	Ch1_Out08	Output CH1 bit 08	RW	BOOL			
	Ch1_Out09	Output CH1 bit 09	RW	BOOL			
	Ch1_Out10	Output CH1 bit 10	RW	BOOL			
	Ch1_Out11	Output CH1 bit 11	RW	BOOL			
	Ch1_Out12	Output CH1 bit 12	RW	BOOL			
	Ch1_Out13	Output CH1 bit 13	RW	BOOL			
	Ch1_Out14	Output CH1 bit 14	RW	BOOL			

- To display I/O ports, you must register the Units in advance in **CPU/Expansion Racks** under **Configurations and Setup** in the Multiview Explorer. After registering a Unit, all I/O ports of that Unit are registered automatically.
- Click the icons in the **Port** Column (▶, ▼) to expand or collapse the display of I/O port configuration for the CPU Rack, Expansion Rack, or Unit.
- For variables to appear in the selection lists, you must first register them in the global variable table.
- You can also enter a variable directly from the I/O map to create a new global variable.

I/O Map Columns

The contents of the I/O Map columns are described below.

Column	Meaning	Editable
Position	Display information on the position of the Unit (for Rack or Unit lines only).	No
Port	Displays the networks and Units that the I/O port belongs to in a nested hierarchy. If more than one variable is registered to the same port, a caution icon and tooltip are displayed.	No
Description	Displays a description of the I/O port.	No
R/W	Displays the Read/Write attribute of the I/O port as shown below. Read only: R, Write only: W, Read/Write: RW	No
Data type	Displays the data type of the I/O port. The basic data types and arrays of the basic data types are displayed.	No

Column	Meaning	Editable
Variable	<ul style="list-style-type: none"> You can enter a variable directly into the Variable cell to assign that variable to the port. If the variable you enter is already assigned to another port, or if that variable is already defined under a different data type, an error icon and tooltip are displayed. The variable assigned to the I/O port is displayed here. If no variable is assigned to the I/O port, this cell is blank. Select Mapping List from the popup menu to display all variables assigned to the selected port. 	Yes
Variable comment	<ul style="list-style-type: none"> Displays comments for the variable. You can edit the comments. If there is text in the Variable cell, you can edit the comment cell. 	Yes
Variable type	<ul style="list-style-type: none"> Displays the variable table that the device variable belongs to. You can edit the table. Select one of the following variable tables from the box. Global variables and registered programs, functions, and function blocks If a variable is assigned to the I/O port, the variable table that the variable belongs to is displayed. If no variable is assigned to the I/O port, this cell is initially blank. If it is blank, the global variable table is selected. 	Yes

7-4-2 Assigning Axis Variables and I/O Devices

● Assigning Axis Variables and I/O Devices

You can define Axis Variables that are used in the program and the I/O devices that actually operate the device.

Assign Axis Variables to Drives mounted as EtherCAT slaves and NX-series Position Interface Units.

● Procedure to Assign Axis Variables and I/O Devices

As an example, the procedure to assign EtherCAT slaves to the Axis Variables that are registered in the Multiview Explorer is given below.

- 1 Double-click the Axis Variable under **Configurations and Setup - Motion Control Setup - Axis Settings** in the Multiview Explorer. Or, right-click the Axis Variable and select **Edit** from the menu.
- 2 The Basic Axis Settings () are displayed. Enter the axis number, axis use, axis type, and feedback information. You can select from the lists. Select the EtherCAT slave to assign from the list in the Input device Text Box.
The specified variable is displayed as shown below.

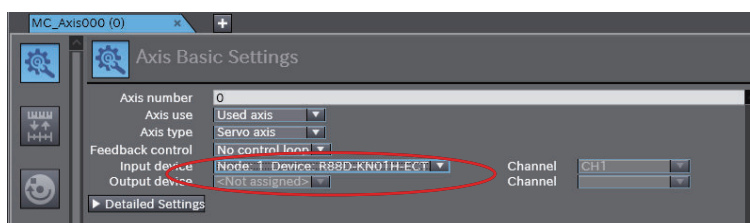

- You must register the axis to use for the axis variable in advance under **Configurations and Setup - Motion Control Setup - Axis Settings** in the Multiview Explorer. When you register an axis, the variable for that axis is automatically registered as well.
- For the EtherCAT slave to appear in the list in the Input device Text Box, an EtherCAT slave Axis Function Unit must be registered in advance under **Configurations and Setup - EtherCAT** in the Multiview Explorer.

After registering an Axis Function Unit, the EtherCAT slave of that Unit is registered automatically.

7-5 Performing Online Debugging

You can check and adjust the operation of programs you develop by establishing an online connection between the Sysmac Studio and your NJ/NX/NY-series Controller, then changing variables to TRUE or FALSE, changing present values, and performing other debugging tasks.

This involves the following operations.

- Transferring data to/from the Controller
- Testing axis operation
- Checking I/O wiring
- Checking I/O assignments
- Resetting the Controller
- Restarting Units

WARNING

- Check the user program for proper execution before you use it for actual operation.
- If you use EtherCAT slaves, check the specifications of those slaves in manuals or other documentation and confirm that the system will not be adversely affected before you transfer parameters.



CAUTION

- Sufficiently confirm safety at the connected slave or Unit before you change the value of an I/O port or device variable.
Not doing so may result in injury.
- Always confirm safety at the destination node before you transfer parameters or data from the Sysmac Studio to another node.
Not doing so may result in injury.



Precautions for Safe Use

- Unexpected operation may result if you transfer inappropriate network configuration settings. Even if appropriate network configuration settings are set, confirm that the controlled system will not be adversely affected before you transfer the data.
- Always confirm the safety of the system before you change the operating mode of the Controller.
- Always confirm safety at the destination node before you transfer parameters or data from the Sysmac Studio to another node on the network configuration.
Not doing so may result in injury.
- Before you restart operation, make sure that the required data, including device variables, the user program, and parameters, is transferred to a CPU Unit, Special I/O Unit, CPU Bus Unit, or externally connected device that was replaced.
- After you transfer the user program, the CPU Unit is restarted and communications with the EtherCAT slaves are cut off. During that period, the slave outputs behave according to the slave specifications. The time that communications are cut off depends on the EtherCAT network configuration. If the EtherCAT network configuration contains only OMRON EtherCAT slaves, communications are cut off for a maximum of 45 seconds.
Before you transfer the user program, confirm that the system will not be adversely affected.
- If you transfer only selected programs from the programs that did not match for the synchronization function, there is no way to check on the Sysmac Studio the integrity with the programs that you do not transfer. After you transfer the programs, confirm safety before you change the CPU Unit to RUN mode.

7-5-1 Transferring/Comparing Data to/from the Controller

You can transfer the user program, system configuration, and variable information from the Sysmac Studio to the Controller, or transfer data from the Controller to the Sysmac Studio to have the same data in the Sysmac Studio and the Controller.

Synchronizing (Uploading/Downloading after Automatic Verification)

● Synchronizing

“Synchronize” means to automatically compare the data for the Sysmac Studio on the computer with the data in the NJ/NX/NY-series Controller and transfer the data in the direction that is specified by the user.

Use the following procedure.

- Download: Select **Synchronization** from the **Controller** Menu, and then click the **Transfer To Controller** Button.
- Upload: Select **Synchronization** from the **Controller** Menu, and then click the **Transfer From Controller** Button.



Precautions for Correct Use

Do not perform any other operations on the Sysmac Studio while the Synchronization Window is active.
An error occurs and synchronization may be impossible.



Additional Information

- As shown above, the *Synchronization* Menu Command is used to both *upload* and *download* data on the Sysmac Studio.
The following terms are used in the NJ/NX/NY-series Controller manuals:
 - a) Transferring data from the Sysmac Studio to the Controller: **Download**
 - b) Transferring data from the Controller to the Sysmac Studio: **Upload**
- Information on synchronization is updated in the project file when synchronization is performed. After you perform synchronization, save the project file before you close it.
If you do not save the project file, a message that says that *the program execution IDs are different and that all data will be transferred* is displayed the next time you perform synchronization.

● Automatic Verification Procedure

- 1 Physically connect the computer to the Controller and then select **Online** from the **Controller** Menu. (Or click the  Button.)

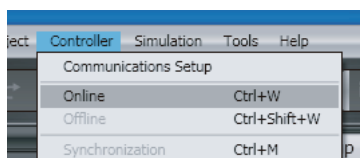

The Sysmac Studio goes online with the Controller.

- 2 Select **Synchronization** from the **Controller** Menu. (Or, click the  Button on the toolbar.)

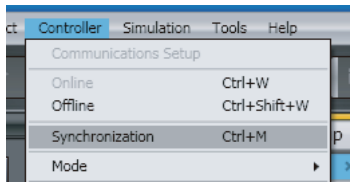

The Synchronization Window is displayed and verification of the user program and parameter settings between the Sysmac Studio and the Controller is started.

You can press the **Cancel** Button to cancel the operation.

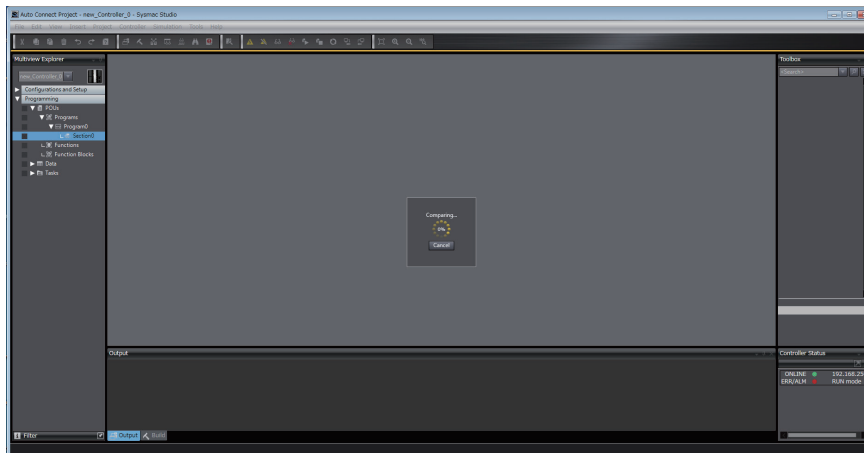

Additional Information

If you change comments or undo changes in a program, the verification results will show that the data is different even when the algorithm of the program is the same.

At this time, you can execute a program algorithm check to see if the algorithm is the same. The program algorithm check is enabled or disabled in the option settings. If it is enabled, the program algorithm check is performed for any data with a different update date between the Controller and project. If there is a lot of data with different update dates, an execution confirmation dialog box is displayed. Time is sometimes required for the program algorithm check. Refer to *8-26 Sysmac Studio Option Settings* on page 8-166 for details on the option settings. In the following cases, the results will always show that the data does not match for the program algorithm check.

- The version of Sysmac Studio that was used to create the data is different between the Controller and the project.
- If a Differentiation Flag is added to and deleted from a program, but the order of the operations is different between the Controller and the project.

● Verification Results

The verification results are displayed as shown below. When valid data is not present, - is displayed.

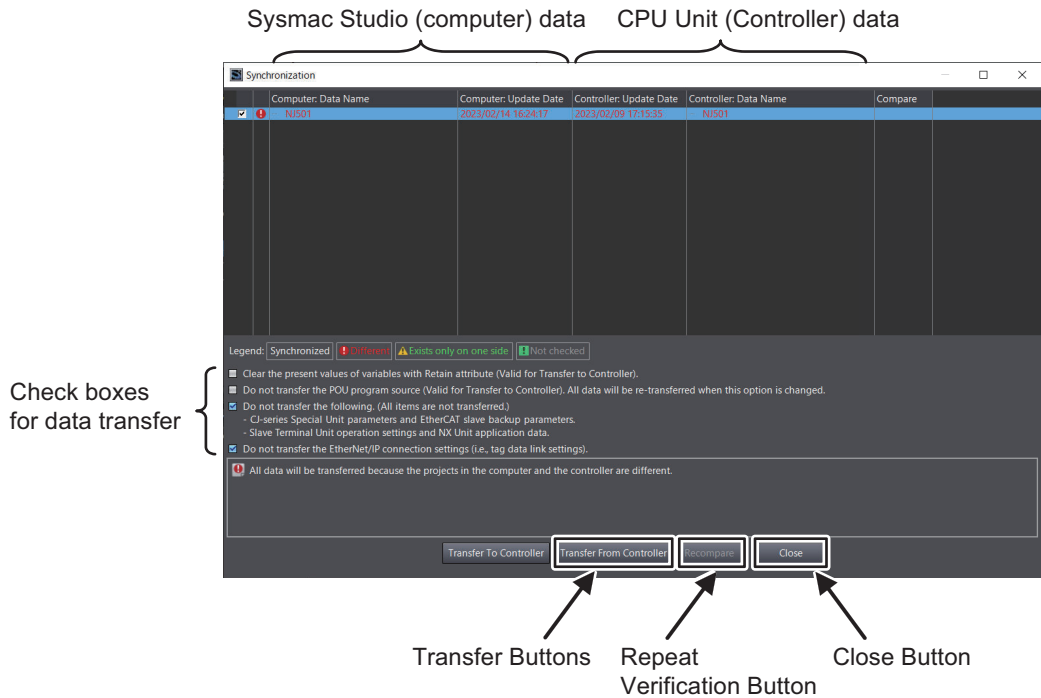

Verification Results Example

The verification results are displayed as shown in the following example.

Column	Item
Computer: Data Name	Project name on the Sysmac Studio
Computer: Update Date	The last time that the project was built on the Sysmac Studio
Controller: Data Name	The project name on the NJ/NX/NY-series Controller
Controller: Update Date	The last time that the project on the NJ/NX/NY-series Controller was built
Compare	*1

*1. If there are differences in the synchronized data, a **...** Button is displayed in the Details Column. Refer to the following page for details.

Verification Units

The units for comparison that are shown in the Synchronization Window are listed in the following table.

Synchronization data name	Level	Qty	Detailed comparison	Remarks
Controller name	1	1	None	
EtherCAT Master Settings	2	1	None	
EtherCAT Slave Settings	2	1	None	
Slaves	3	N	None	The settings of the selected slaves are transferred.
CPU/Expansion Racks*1	2	1	None	
CPU Rack : X Bus*2	3	1	None	
X Bus Units*2	4	N	None	
CPU Rack : NX Bus*2	3	1	None	



Synchronization data name	Level	Qty	De-tailed comparison	Remarks
CPU Rack* ¹	3	1	None	For an NJ-series Controller, transferred to memory used for CJ-series Units.
NX Units* ³	4	N	None	
Units* ⁴	4	1	None	
Units* ⁴	5	N	None	
Expansion Racks* ⁴	3	1	None	
Units* ⁴	4	1	None	
Units* ⁴	5	N	None	
Controller Setup	2	1	None	
Operation Settings	3	1	None	
Built-in EtherNet/IP Port Settings	3	1	None	
Built-in I/O Settings* ⁵	3	1	None	
Option Board Settings* ⁵	3	1	None	
Memory Settings* ³	3	1	None	
Motion Control Setup	2	1	None	
Axis Settings	3	1	None	
Axes Group Settings	3	1	None	
Cam Data Settings	2	1	None	
CamProfile	3	N	None	
Event Settings	2	1	None	
Task Settings	2	1	None	
POUs	2	1	None	
Programs	3	1	None	
Programs	4	N	None	Ladder programs
Variable table	5	1	Available	Ladder programs
Section	5	N	Available	Ladder programs
Programs	4	N	None	ST programs
Variable table	5	1	Available	ST programs
Program Body	5	1	Available	ST programs
Functions	3	1	None	
Function	4	N	None	Ladder programs
Variable table	5	1	Available	Ladder programs
LadderBody	5	1	Available	Ladder programs
Function	4	N	None	ST programs
Variable table	5	1	Available	ST programs

Synchronization data name	Level	Qty	Detailed comparison	Remarks
Program Body	5	1	Available	ST programs
Function Blocks	3	1	None	
FunctionBlock	4	N	None	Ladder programs
Variable table	5	1	Available	Ladder programs
LadderBody	5	1	Available	Ladder programs
FunctionBlock	4	N	None	ST programs
Variable table	5	1	Available	ST programs
Program Body	5	1	Available	ST programs
Data	2	1	None	
Data Types	3	1	Available	
Global Variables	3	1	Available	
Libraries	2	1	None	
The data from this level depends on the structure of the library. (The data that can be verified is the same as the data that is given above.)				

- *1. This is displayed only for an NJ-series Controller and NX502, NX102, or NX1P2 Controller.
*2. This is displayed only for an NX502 Controller.
*3. This is displayed only for an NX502, NX102, or NX1P2 Controller.
*4. This is displayed only for an NJ-series Controller.
*5. This is displayed only for an NX1P2 Controller.

Icons and Display Text Colors

The verification results are displayed with icons and display text colors.

Icon	Text color	Status	Description
	White	Synchronized	The Sysmac Studio data and NJ/NX/NY-series Controller data are the same.
	Red	Difference	The Sysmac Studio data and NJ/NX/NY-series Controller data are not the same. The following cases are displayed as differences. <ul style="list-style-type: none"> When there is even one difference in the data for a verification item When the display order of synchronized data is not the same (If the display order is not the same, the data is displayed in the order on the Sysmac Studio.)
	Green	Data missing	The data exists either only in the NJ/NX/NY-series Controller or only on the Sysmac Studio.

Icon	Text color	Status	Description
	Gray	Build not completed	The project is not built or an error has occurred.
		Non-synchronized data	This icon is displayed for parameters for CJ-series Special Units and EtherCAT slaves.

Repeating Verification

Click the **Recompare** Button to repeat the verification.

● Uploading and Downloading Data

If there are any differences in the data, the following dialog box is displayed after automatic verification.

Example for an NJ-series Controller

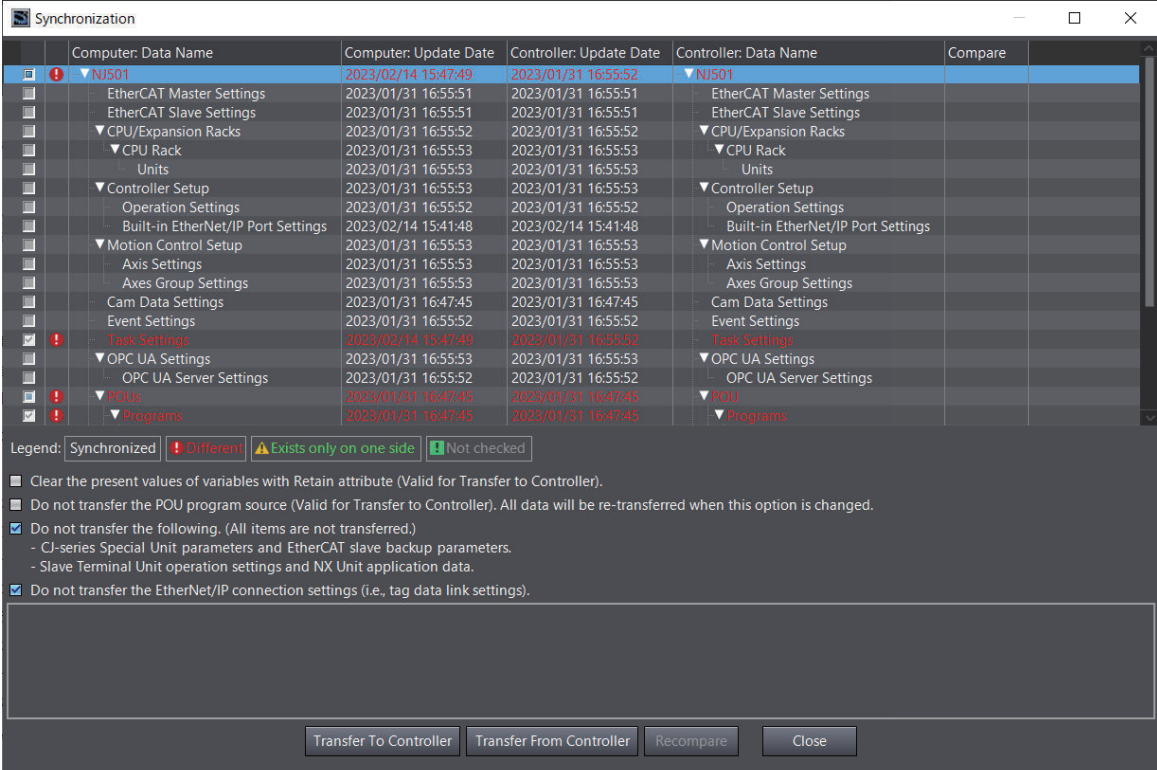

Computer: Data Name	Computer: Update Date	Controller: Update Date	Controller: Data Name	Compare
▼ NJ501	2023/02/14 15:47:49	2023/01/31 16:55:52	▼ NJ501	
EtherCAT Master Settings	2023/01/31 16:55:51	2023/01/31 16:55:51	EtherCAT Master Settings	
EtherCAT Slave Settings	2023/01/31 16:55:51	2023/01/31 16:55:51	EtherCAT Slave Settings	
▼ CPU/Expansion Racks	2023/01/31 16:55:52	2023/01/31 16:55:52	▼ CPU/Expansion Racks	
▼ CPU Rack	2023/01/31 16:55:53	2023/01/31 16:55:53	▼ CPU Rack	
Units	2023/01/31 16:55:53	2023/01/31 16:55:53	Units	
▼ Controller Setup	2023/01/31 16:55:53	2023/01/31 16:55:53	▼ Controller Setup	
Operation Settings	2023/01/31 16:55:52	2023/01/31 16:55:52	Operation Settings	
Built-in EtherNet/IP Port Settings	2023/02/14 15:41:48	2023/02/14 15:41:48	Built-in EtherNet/IP Port Settings	
▼ Motion Control Setup	2023/01/31 16:55:53	2023/01/31 16:55:53	▼ Motion Control Setup	
Axis Settings	2023/01/31 16:55:53	2023/01/31 16:55:53	Axis Settings	
Axis Group Settings	2023/01/31 16:55:53	2023/01/31 16:55:53	Axis Group Settings	
Cam Data Settings	2023/01/31 16:47:45	2023/01/31 16:47:45	Cam Data Settings	
Event Settings	2023/01/31 16:55:52	2023/01/31 16:55:52	Event Settings	
Task Settings	2023/02/14 15:47:49	2023/01/31 16:55:52	Task Settings	
▼ OPC UA Settings	2023/01/31 16:55:53	2023/01/31 16:55:53	▼ OPC UA Settings	
OPC UA Server Settings	2023/01/31 16:55:52	2023/01/31 16:55:52	OPC UA Server Settings	
▼ POU	2023/01/31 16:47:45	2023/01/31 16:47:45	▼ POU	
▼ Programs	2023/01/31 16:47:45	2023/01/31 16:47:45	▼ Programs	

Legend: ■ Synchronized ■ Different ■ Exists only on one side ■ Not checked

Clear the present values of variables with Retain attribute (Valid for Transfer to Controller).

Do not transfer the POU program source (Valid for Transfer to Controller). All data will be re-transferred when this option is changed.

Do not transfer the following. (All items are not transferred.)

- CJ-series Special Unit parameters and EtherCAT slave backup parameters.
- Slave Terminal Unit operation settings and NX Unit application data.

Do not transfer the EtherNet/IP connection settings (i.e., tag data link settings).

Transfer To Controller Transfer From Controller Recompare Close

Procedure

- 1 Select the items to check for synchronization. The transfer process depends on which of these items are selected. This is shown in the following table.

Synchronization Check Items

Item	Default	When transfer is enabled	Description
Clear the present values of variables with Retain attribute (Valid for Transfer to Controller).	Not selected.	Values written to Controller	If this check box is selected, the present values of Retain variables are cleared after the data is downloaded.

Item	Default	When transfer is enabled	Description
Do not transfer the POU program source (Valid for Transfer to Controller). All data will be re-transferred when this option is changed. *1	Not selected.	Values written to Controller	If this check box is selected, programs are not displayed when they are uploaded from another computer. However, variables and settings are transferred even if this check box is selected.
Do not transfer the following. (All items are not transferred) <ul style="list-style-type: none"> NX Unit application data on the CPU Rack*2 and CJ-series Special Unit parameters*3 and EtherCAT slave backup parameters*4 Unit operation settings and NX Unit application data on Slave Terminals. X Bus Unit settings.*5 	Selected.	Transferred both direction	If this check box is selected, the following parameters and data are not transferred. <ul style="list-style-type: none"> CJ-series Special Unit and EtherCAT slave*6*7 parameters Unit operation settings and application data for NX Units
Do not transfer the EtherNet/IP connection settings (i.e., the tag data link settings).	Selected.	Transferred both directions	If this check box is selected, the EtherNet/IP connection settings are not transferred. For information on EtherNet/IP connection settings, refer to the <i>NJ/NX-series CPU Unit Built-in EtherNet/IP Port User's Manual (Cat. No. W506)</i> or <i>NY-series Industrial Panel PC / Industrial Box PC Built-in EtherNet/IP Port User's Manual (Cat. No. W563)</i> .

- *1. When this check box is changed from Selected to Not selected without transferring the program source to the Controller, all data is transferred.
- *2. This is displayed only for an NX502, NX102, or NX1P2 Controller.
- *3. This is displayed only for an NJ-series Controller.
- *4. Data is not transferred if the data in the Controller and on the Sysmac Studio are not the same.
- *5. This is displayed only for an NX502 Controller.
- *6. Parameters for ZW-series Displacement Sensors are not transferred regardless of whether this check box is selected or not. To transfer parameters for a Displacement Sensor, right-click the Displacement Sensor and select **Online** from the pop-up menu. A **Synchronization** Dialog Box is displayed. Click the **Transfer from Sensor** or **Transfer to Sensor** Button to transfer the parameters.
- *7. Parameters for FQ-M-series Vision Sensors and FH-series Vision Sensors are not transferred regardless of whether this check box is selected or not. When the data is uploaded, the parameters for Vision Sensors in the project are initialized. Connect the computer and Vision Sensor via Ethernet to transfer the parameters for a Vision Sensor. Display the Online View from the Edit Menu of the Vision Sensor, and then click the **Transfer from Sensor** or **Transfer to Sensor** Button. For an FQ-M-series Vision Sensor, change to Setup Mode first.

2 Select the items to transfer from the verification results in the Details Area of the Synchronization Window.

- If the data in the computer is correct Click the **Transfer To Controller** Button (download).
- If the data in the Controller is correct Click the **Transfer From Controller** Button (upload).

The Sysmac Studio data and Controller data will be the same after the transfer.

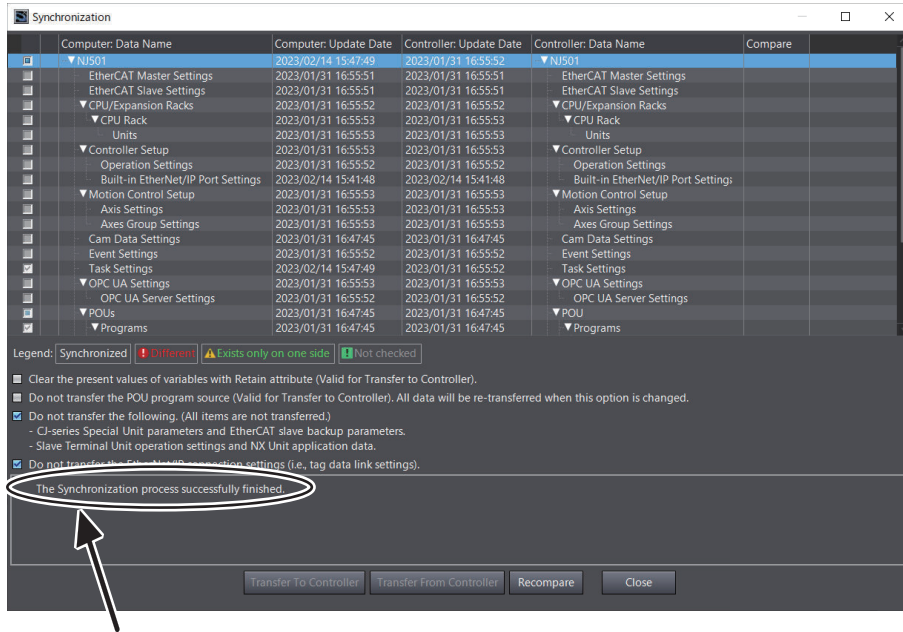

This is displayed if the synchronization process is completed successfully.



Precautions for Correct Use

- If the data does not match when the comparison is completed, the only action that is possible is to write the data that is required to make the data from the Sysmac Studio match that on the NJ/NX/NY-series Controller. If any other write functions are executed at this time, an execution error occurs (you cannot change present values).
To continue, you must first clear this state. To do so, select **Release Access Right** from the **Controller Menu**.
- If a program algorithm check was performed, the check boxes for the programs for which the algorithm check was performed are selected to transfer the data regardless of the comparison results.
Even if there are differences in rung comments, variable comments, or element comments, the comparison results will show a match. If you don't want to overwrite comments when the data is transferred, clear the selection of the check box of the program unit.
- If an error occurs during data transfer, the EtherNet/IP connection settings are not transferred. If an error occurs, transfer the EtherNet/IP connection settings from the **Built-in EtherNet/IP Port Connection Settings** Tab Page.
- If the following data are transferred to the Controller after they are added, deleted or changed, the retention operation for the present values of variables may be different depending on the unit version of the CPU Unit: members of a structure variable or union variable with the retain attribute, or elements of an array variable with the retain attribute. For details on the retention operation, refer to the *NJ/NX-series CPU Unit Software User's Manual (Cat. No. W501)* or *NY-series Industrial Panel PC / Industrial Box PC Software User's Manual (Cat. No. W558)*.



Additional Information

- If the following are the same, the program POUs can be transferred individually.
 - a) Data types
 - b) Global variables
 - c) All function block POUs
 - d) All function POUs
 - e) All libraries

● Closing the Synchronization Window

Click the **Close** Button to close the Synchronization Window.

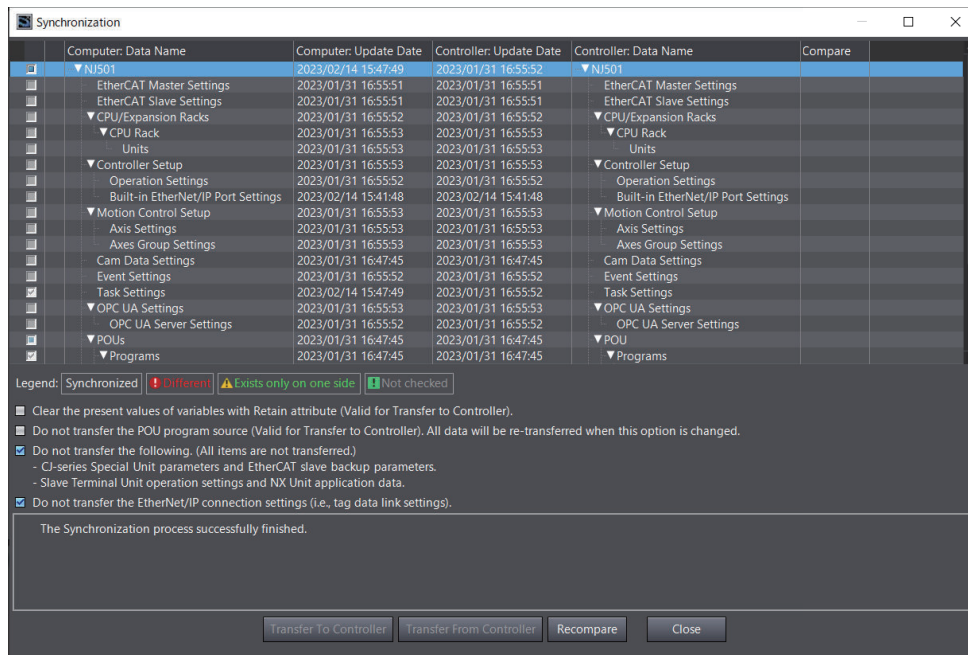

● Verification Details

You can perform detailed verifications for POU's (i.e., ST and ladder programs, functions, and function blocks).

Click the button in the **Compare** Column (**...**) in the Synchronization Window.

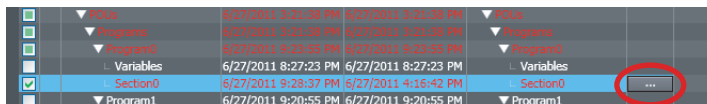

The Verify Details Pane is displayed.

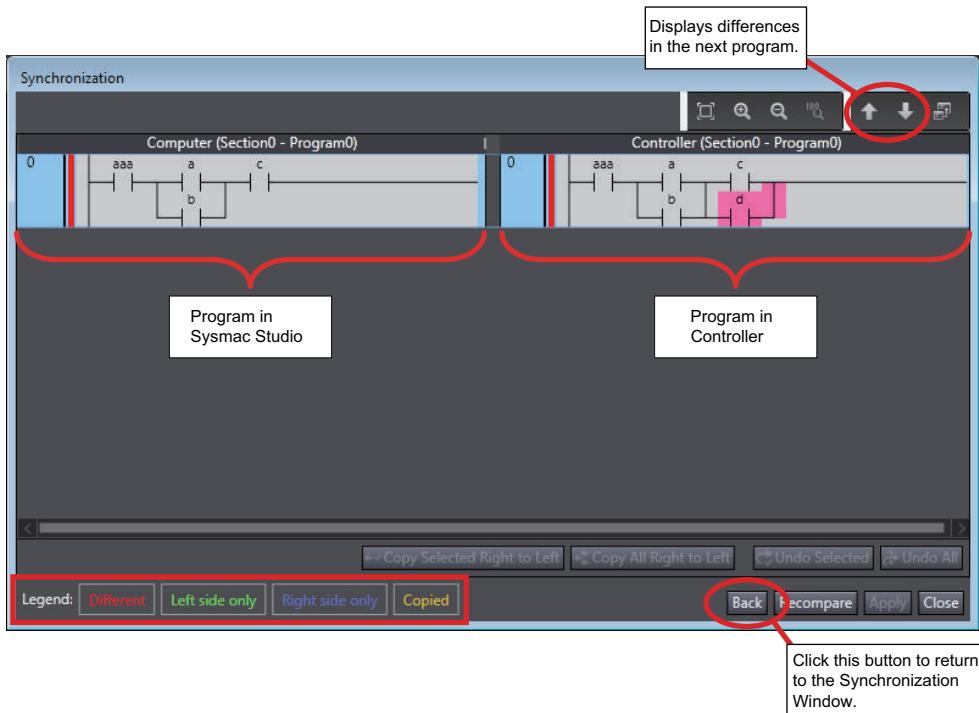

The differences in the program on the Sysmac Studio are displayed with the following background colors.

Background color	Meaning
No change	The rung or line is the same on the Sysmac Studio and the Controller.
Red	The rung or line exists on both the Sysmac Studio and the Controller, but there are differences.
Green	The rung or line exists only on the Sysmac Studio.
Blue	The rung or line exists only in the Controller.



Additional Information

If there are no differences, *Identical* is displayed in a message dialog box.

● Device Output Holding during Transfer

CPU Units with unit version 1.13 or later, when combined with Sysmac Studio version 1.17 or higher, can hold device output when transferring data from the computer to a Controller under specific settings and conditions. Refer to the *NJ/NX-series CPU Unit Software User's Manual (Cat. No. W501)* for details on the settings and conditions for holding device output.



Precautions for Correct Use

Confirm that the system will not be adversely affected before you transfer the parameters.



Additional Information

If the data being transferred from the computer to the Controller contains any setting that prevents the CPU Unit from holding device output, a confirmation message is displayed. To enable the CPU Unit to hold device output in this case, cancel the transfer, change the setting that prevents the CPU Unit from holding device output back to the previous setting, and execute the transfer again.

If the confirmation message still appears, use the following procedure to create the project data again before you execute the transfer.

1. **Export the current project.** Refer to **3-3-7 Exporting a Project File** on page 3-19 for the export procedure.
2. **Leaving the current project intact, launch another copy of the Sysmac Studio, connect it to the Controller, and transfer data from the Controller to the computer. Go offline after the data is transferred.** Refer to **6-2-8 Going Online without a Project** on page 6-9 for the procedure. A new project is now created. In the next step and later, you will perform operations on the new project.
3. **Apply the changes that you made under POU's and Data in the Multiview Explorer to the project created in step (2). Perform offline comparison with the project created in step (2) and the file that you exported in step (1) and use the merge function to apply the changes that you made under POU's and Data to the project created in step (2).** Refer to **4-11 Offline Comparison** on page 4-180 for the offline comparison and merging procedures.
4. **Apply the changes that you made under items other than POU's and Data to the project that you created in step (2). Compare the current project with the project created in step (2) on the display and, for setting items in the current project to which changes do not prevent the CPU Unit from holding device output, apply the changes to the project created in step (2).**
5. **From the project created in step (2), go online and transfer the data to the Controller.**

● Continuing Safety Process Data Communications during Transfer

If you are using an NX-series Safety Control Unit, if certain conditions are met, safety process data communications will be continued during data transfer from the computer to a Controller.

Safety system's safety process data communications on an EtherCAT network (FSoE communications)

In the combination of CPU Units with unit version 1.13 or later and Sysmac Studio version 1.17 or higher, when all of the following conditions are met

- The synchronization check item *Do not transfer the following. (All items are not transferred.)* is selected.
- Only the following items have been changed since the previous synchronization.

Item	
EtherCAT	Backup Parameter Settings of EtherCAT slaves
CPU/Expansion Racks	Special Unit Settings of CJ-series Units
I/O Map	
Event Settings	
Task Settings	Program Assignment Settings
POUs	Programs
	Functions
	Function Blocks
Data	Data Types
	Global Variables
Libraries	

Item	
EtherNet/IP Connection Settings	Built-in EtherNet/IP Port Settings
DB Connection Settings	

If you change an item other than the above to cause a mismatch, the CPU Unit cannot continue safety process data communications when transferring data from the computer to the Controller.



Additional Information

If the data being transferred from the computer to the Controller contains any setting that prevents safety process data communications, a confirmation message is displayed. To continue safety process data communications in this case, cancel the transfer, change the setting that prevents continuing safety process data communications back to the previous setting, and execute the transfer again.

If the confirmation message still appears, use the following procedure to create the project data again before you execute the transfer.

1. **Export the current project. Refer to 3-3-7 *Exporting a Project File* on page 3-19 for the export procedure.**
2. **Leaving the current project intact, launch another copy of the Sysmac Studio, connect it to the Controller, and transfer data from the Controller to the computer. Go offline after the data is transferred. Refer to 6-2-8 *Going Online without a Project* on page 6-9 for the procedure. A new project is now created. In the next step and later, you will perform operations on the new project.**
3. **Apply the changes that you made under POU's and Data in the Multiview Explorer to the project created in step (2). Perform offline comparison with the project created in step (2) and the file that you exported in step (1) and use the merge function to apply the changes that you made under POU's and Data to the project created in step (2). Refer to 4-11 *Offline Comparison* on page 4-180 for the offline comparison and merging procedures.**
4. **Apply the changes that you made under items other than POU's and Data to the project that you created in step (2). Compare the current project with the project created in step (2) on the display and, for setting items in the current project to which changes do not prevent the CPU Unit from continuing safety process data communications, apply the changes to the project created in step (2).**
5. **From the project created in step (2), go online and transfer the data to the Controller.**

Safety system's safety process data communications through an EtherNet/IP network (CIP Safety communications)

When the following condition is met during the use of the NX502 or NX102 CPU Unit or NX-CSG Communication Control Unit, in addition to the conditions specified in the *Safety system's safety process data communications on an EtherCAT network (FSOE communications)*

- The synchronization check item *Do not transfer the EtherNet/IP connection settings (i.e., tag data link settings)* Check Box is selected.

Or, if the *Do not transfer the EtherNet/IP connection settings (i.e., tag data link settings)* Check Box is not selected, the comparison results of the EtherNet/IP connection settings for each EtherNet/IP port match.



Additional Information

- If the **Do not transfer the EtherNet/IP connection settings (i.e., tag data link settings)** Check Box is not selected, safety process data communications will stop only on ports with mismatched comparison results of the EtherNet/IP connection settings.
- You can check the comparison results of the EtherNet/IP connection settings in each **EtherNet/IP Connection Settings** Tab Page.
- For NX502 CPU Units, CIP Safety on EtherNet/IP communications can be performed through an EtherNet/IP port of the NX-series EtherNet/IP Unit mounted. The built-in EtherNet/IP port of NX502 CPU Units with unit version 1.64 or later supports CIP Safety on EtherNet/IP communications.

● Transfer Option for Comment and Programming Group Information

You can exclude the comments in programs, variable comments, and programming group information from the data that is transferred to the Controller. This option is set for each Controller that is registered in a project.

- 1 Go online, right-click the device icon in the Multiview Explorer, and select **Property** from the menu.

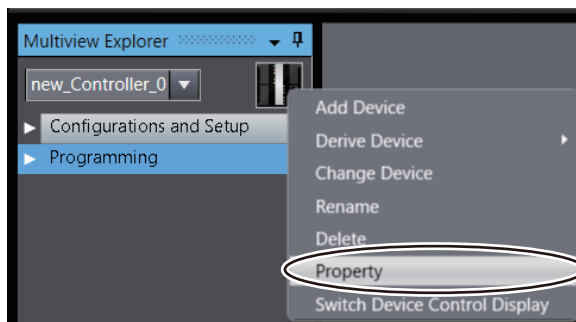

The **Property** Dialog Box is displayed.

- 2 Select the **Do not transfer the comments and the programming group information to the controller** Check Box in the **Property** Dialog Box that is displayed and click the **OK** Button.

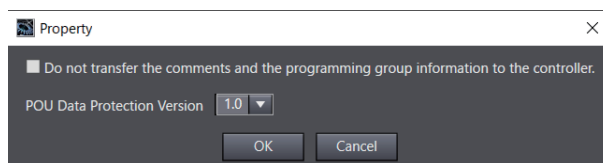

- 3 Build the project.
You can transfer the data without the comments and the programming group information.



Precautions for Correct Use

- The setting of this option cannot be changed in the synchronization option settings in the Synchronization Window.
- This option is different from the option settings on the **Tools** menu in that it must be set for each Controller in every project.
- Even in the case any comment or programming group information is not transferred, use of this option does not affect the operation of the Controller.



Additional Information

- If you select the **Do not transfer the comments and the programming group information to the controller** Check Box and transfer the data to the Controller, the comments, element comments, and programming group information will not be restored when you upload the data from the Controller.
- You cannot set this transfer option for library projects. The **Property** menu command is grayed out. The transfer of comments in a library is controlled by the settings of this transfer option for the Controller in the project that accesses the library.

Synchronizing, Transferring, and Comparing the EtherCAT Configuration

These functions allow you to synchronize data between the Sysmac Studio and an NJ/NX/NY-series Controller through various methods. You can transfer actual network configurations from the NJ/NX/NY-series Controller to the Sysmac Studio and transfer slave backup parameter settings from the Sysmac Studio to the NJ/NX/NY-series Controller or from the NJ/NX/NY-series Controller to the Sysmac Studio.

● Procedure to Display the Compare and Merge with Actual Network Configuration Dialog Box

- 1** Double-click **EtherCAT** under **Configurations and Setup** in the Multiview Explorer. Or, right-click **EtherCAT** under **Configurations and Setup** and select **Edit** from the menu. The EtherCAT Tab Page is displayed in the Edit Pane.
- 2** Right-click the master in the EtherCAT Tab Page and select **Compare and Merge with Actual Network Configuration**. The actual network configuration is read and compared with the network configuration on the Sysmac Studio. The results are displayed in the **Compare and Merge with Actual Network Configuration** Dialog Box.

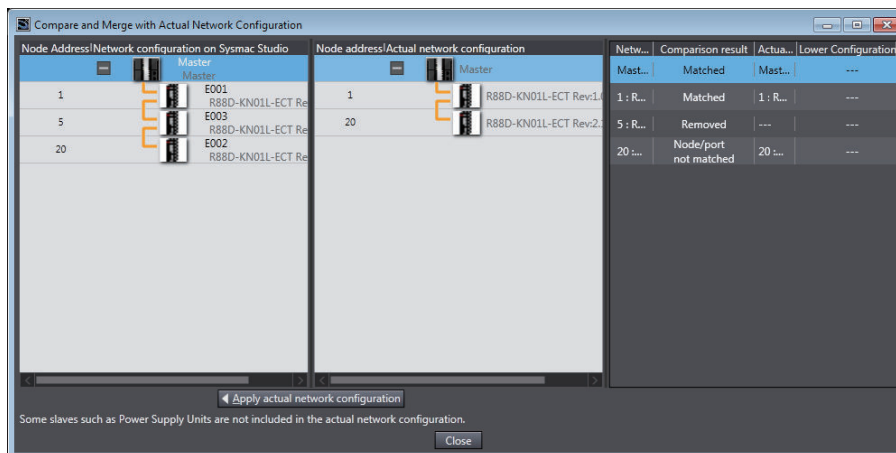

- 3** If there are slaves for which the comparison results do not match, correct the network configuration on the Sysmac Studio or correct the actual network configuration until the comparison results for all slave match.

To correct the network configuration in the Sysmac Studio, you can drag slaves from the actual network configuration to the Sysmac Studio network configuration, or you can delete slaves from the Sysmac Studio network configuration.

If you correct the actual network configuration, click the **Close** Button, return to the EtherCAT Tab Page and start the Compare and Merge with Actual Network Configuration Dialog Box again to confirm the comparison results again.

- 4** Click the **Close** Button.
The EtherCAT Tab Page is displayed.



Additional Information

- You can right-click a Unit in the actual configuration in the Compare and Merge Window and select **Apply actual network configuration** to use the actual network configuration information as the configuration information in the project.
If you use this menu command, all of the variable assignments for I/O ports and I/O allocation settings in the task settings in the project will be cleared.
- **Matched, Deleted, Added, Moved, and Node/port not matched** are displayed in the **Comparison results** Column to give the results of comparing the network configuration on the Sysmac Studio with the actual network configuration.
The following items are compared.
 - a) Node addresses
 - b) Vendor IDs
 - c) Product codes
 - d) Revisions
 - e) Connection ports
 The results that are displayed in the Comparison results Column have the following meanings.
 - Matched:** All of the comparison items match for the slave.
 - Deleted:** The slave exists only in the network configuration on the Sysmac Studio.
 - Added:** The slave exists only in the actual network configuration.
 - Moved:** The slave is connected in a different order.
 - Node/port not matched:** There is a difference in the connected Unit or connected port on the connected Unit for the slave.



Precautions for Correct Use

- Make sure that the communications cables between the master and slaves are connected correctly before you perform this operation. The **Compare and Merge with Actual Network Configuration** Dialog Box is not displayed if the connections are not correct. Refer to the *NJ/NX-series CPU Unit Built-in EtherCAT Port User's Manual (Cat. No. W505)* or *NY-series Industrial Panel PC / Industrial Box PC Built-in EtherCAT Port User's Manual (Cat. No. W562)* for information on the correct connection methods.
- The **Compare and Merge with Actual Network Configuration** Dialog Box is not displayed if there is a slave in the actual network configuration for which the node address is not set or if the same address is set for more than one slave in the actual network configuration. Make sure that node addresses are set correctly for the slaves in the actual network configuration before you perform this operation.
- When the compare and merge operation is performed, the synchronization between the Sysmac Studio and the Controller is lost. Synchronize the Sysmac Studio and Controller before you perform any online operations for the slaves. Refer to *7-5-1 Transferring/Comparing Data to/from the Controller* on page 7-127 for information on the synchronization operation.

● Procedure for the Comparison and Transfer of Backup Parameter Settings

- 1 Select the slave in the EtherCAT Tab Page.
- 2 Click the **Edit Backup Parameter Settings** Button in the Slave Parameter Settings Area on the right of the EtherCAT configuration.

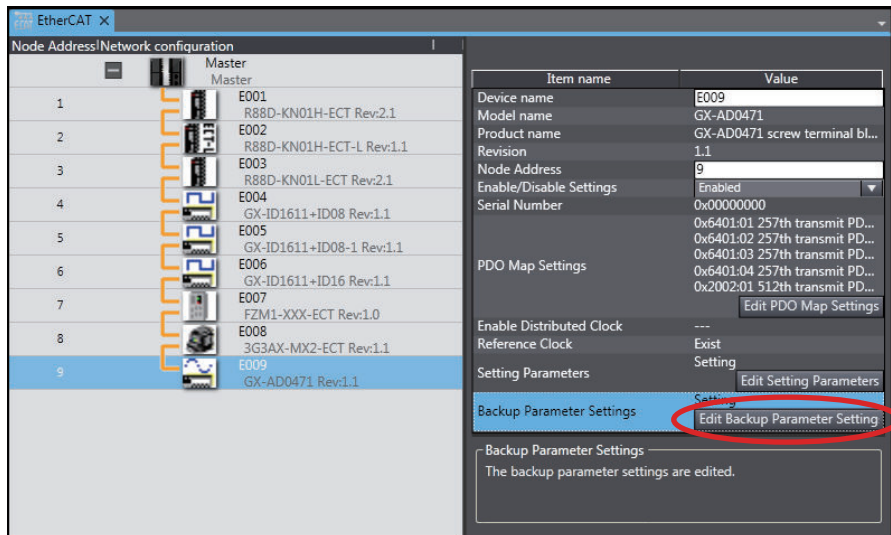

The **Edit Backup Parameter Settings** Tab Page for the selected slave is displayed.

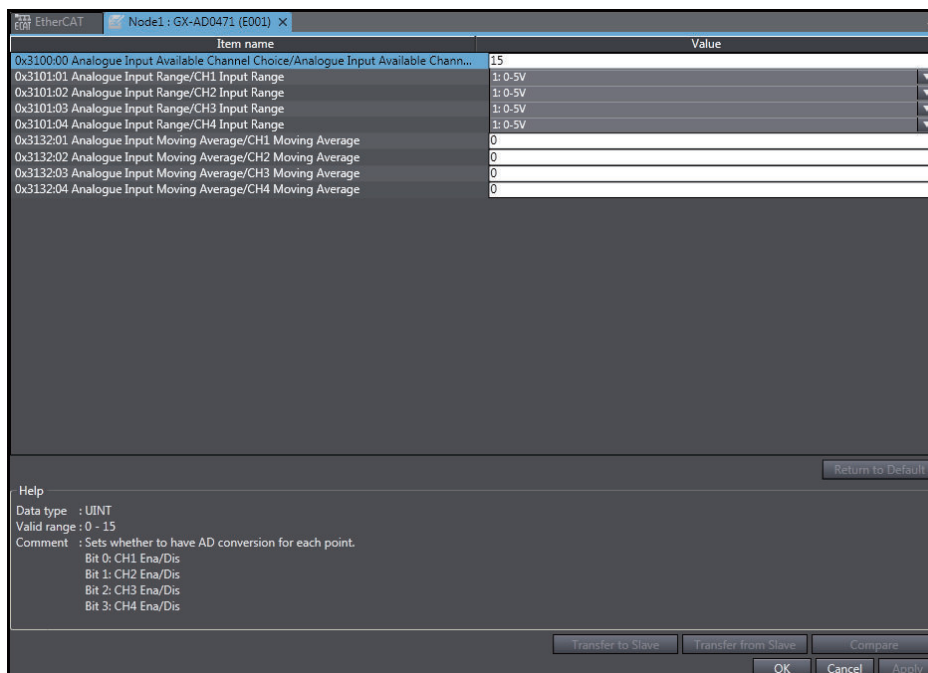

- 3 Click the **Compare** Button.
The parameters in the Sysmac Studio are compared with the parameters from the slave. If any parameters are not the same, they are indicated with “≠” in the results.
- 4 Click the **Transfer from Slave** Button to transfer the backup parameter settings from the slave to the Sysmac Studio.

Click the **Transfer to Slave** Button to transfer the backup parameter settings from the Sysmac Studio to the slave.

Synchronizing, Transferring, and Comparing the EtherCAT Slave Terminal Configuration

These functions allow you to synchronize data between the Sysmac Studio and an NJ/NX/NY-series Controller through various methods. You can transfer the actual Slave Terminal configuration from the NJ/NX/NY-series Controller to the Sysmac Studio and transfer NX Unit settings from the Sysmac Studio to the NJ/NX/NY-series Controller or from the NJ/NX/NY-series Controller to the Sysmac Studio.

● Procedure to Display the Compare and Merge with Actual Unit Configuration Dialog Box

- 1 Double-click the EtherCAT Coupler Unit under **EtherCAT** in the Multiview Explorer. Or, right-click the EtherCAT Coupler Unit under **EtherCAT** and select **Edit** from the menu. The Slave Terminal Tab Page is displayed in the Edit Pane.
- 2 Right-click in the Slave Terminal Tab Page and select **Compare and Merge with Actual Unit Configuration**.
The actual Unit configuration is read and compared with the Unit configuration on the Sysmac Studio. The results are displayed in the **Compare and Merge with Actual Unit Configuration** Dialog Box.



Additional Information

Matched, **Removed**, **Added**, **Disabled**, **Compatible**, and **Not compatible** are displayed in the **Result** column to give the results of comparing the Unit configuration on the Sysmac Studio with the actual Unit configuration. The following items are compared.

- Model numbers
- Unit versions

The results that are displayed in the Result Column have the following meanings.

Matched: All of the comparison items match for the Unit.

Removed: The Unit exists only in the Unit configuration on the Sysmac Studio.

Added: The Unit exists only in the actual Unit configuration.

Disabled: The Unit exists only in the Unit configuration on the Sysmac Studio and it is disabled.

Compatible: A replaceable Unit whose unit version in the actual Unit configuration is later than the unit version in the Unit configuration in the Sysmac Studio.

Not compatible: A non-replaceable Unit whose unit version in the actual Unit configuration is earlier than the unit version in the Unit configuration in the Sysmac Studio.

● Transferring and Synchronizing in the Compare and Merge with Actual Unit Configuration Dialog Box

You can insert Units in the actual Unit configuration into the configuration on the Sysmac Studio. You can also adjust the Unit configuration on the Sysmac Studio to match the actual Unit configuration.

- 1 Drag a Unit in the actual Unit configuration in the comparison results on the **Compare and Merge with Actual Unit Configuration** Dialog Box to the configuration on the Sysmac Studio. The selected Unit is inserted into the configuration on the Sysmac Studio.

- 2 To synchronize the entire Unit configuration, click the **Apply Actual Unit Configuration** Button.
The Unit configuration on the Sysmac Studio will be made the same as the actual Unit configuration.
- 3 Click the **OK** Button.
This returns you to the Unit Editor.



Precautions for Correct Use

If the unit version of the Unit in the actual Unit configuration is not supported by the Sysmac Studio when you select the **Apply Actual Unit Configuration** Button, you can replace it with an earlier unit version.

However, the Unit may not operate properly depending on the unit version. In such a case, you need to update the Sysmac Studio to have the same unit version for the Unit on the Sysmac Studio and the Unit in the actual Unit configuration.



Additional Information

If the Unit in the actual Unit configuration and the Unit in the configuration in the Sysmac Studio have the same model number, but different unit versions, you can apply the unit version in the actual Unit configuration to the Unit configuration in the Sysmac Studio. Right-click in the **Compare and Merge with Actual Unit Configuration** Dialog Box and select **Apply Actual Unit Version** from the menu.

● Transferring and Comparing Unit Operation Settings

For each Unit in the Slave Terminal configuration, you can compare the Unit settings with the settings in the actual Unit and you can transfer the settings.

- 1 Right-click a Unit on the Slave Terminal Tab Page and select **Edit Unit Operation Settings**.
The Unit Operation Settings Tab Page is displayed for the selected Unit.
- 2 Click the **Compare** Button.
The settings in the actual Unit are displayed in the **Comparison Result** column.

Item name	Value	Comparison Result
Channel Enable/Disable Setting/Ch1 Enable/Disable	True	True
Channel Enable/Disable Setting/Ch2 Enable/Disable	True	True
Channel Enable/Disable Setting/Ch3 Enable/Disable	True	True
Channel Enable/Disable Setting/Ch4 Enable/Disable	False	True
Input Type Setting/Ch1 Input Type	E -200 to 1000 [°C]	K -200 to 1300 [°C]
Input Type Setting/Ch2 Input Type	K -200 to 1300 [°C]	K -200 to 1300 [°C]
Input Type Setting/Ch3 Input Type	B 0 to 1800 [°C]	K -200 to 1300 [°C]
Input Type Setting/Ch4 Input Type	K -200 to 1300 [°C]	K -200 to 1300 [°C]
Cold Junction Compensation Enable/Disable Setting/Ch1...	True	True
Cold Junction Compensation Enable/Disable Setting/Ch2...	True	True
Cold Junction Compensation Enable/Disable Setting/Ch3...	True	True

Return to Default Value

Help
Data type: BOOL
Comment: Set whether to enable or disable the channel.
False: Disable

Transfer to Unit Transfer from Unit Compare

- 3** To change the settings in the actual Unit to match those on the Sysmac Studio, click the **Transfer to Unit** Button. To change the settings on the Sysmac Studio to those in the actual Unit, click the **Transfer from Unit** Button.
- The settings are transferred and the comparison results will show that they are the same.
- For details on the parameters and settings for each Unit, refer to the user's manual for the specific Unit.



Precautions for Correct Use

If you execute **Transfer to Unit**, the Unit is restarted after the data is transferred. At that time, I/O communications with the communications master will stop. What is restarted depends on the selected Unit and the unit version of the EtherCAT Coupler Unit. Refer to the *NX-series EtherCAT Coupler Units User's Manual (Cat. No. W519)* for details.



Additional Information

Instead of going online with the Controller, you can connect directly to the EtherCAT Coupler Unit with a USB cable to transfer and compare the Unit operation settings. Refer to *A-8 Directly Connecting to an EtherCAT Slave Terminal* on page A-59 for the procedure to connect directly to the EtherCAT Coupler Unit.

Synchronizing, Transferring, and Comparing the CPU Rack Configuration of an NX502, NX102, or NX1P2 Controller

These functions allow you to synchronize data between the Sysmac Studio and the Controller through various methods. You can transfer the actual X Bus Unit or NX Unit configuration of the CPU Rack from the Controller to the Sysmac Studio and transfer X Bus Unit or NX Unit settings from the Sysmac Studio to the Controller or from the Controller to the Sysmac Studio.

● Procedure to Display the Compare and Merge with Actual Unit Configuration Dialog Box

- 1** For X Bus Units, double-click **CPU Rack : X Bus** under **Configurations and Setup – CPU/Expansion Racks** in the Multiview Explorer. Or, right-click **CPU Rack : X Bus** and select **Edit** from the menu. For NX Units, double-click **CPU Rack** under **Configurations and Setup – CPU/Expansion Racks** in the Multiview Explorer. Or, right-click **CPU Rack : NX Bus** and select **Edit** from the menu.

The CPU and Expansion Racks Tab Page is displayed in the Edit Pane.

- 2** Right-click in the CPU and Expansion Racks Tab Page and select **Compare and Merge with Actual Unit Configuration**.

The actual Unit configuration is read and compared with the Unit configuration on the Sysmac Studio. The results are displayed in the **Compare and Merge with Actual Unit Configuration** Dialog Box.



Additional Information

Matched, **Removed**, **Added**, **Disabled**, **Compatible**, and **Not compatible** are displayed in the **Result** column to give the results of comparing the Unit configuration on the Sysmac Studio with the actual Unit configuration. The following items are compared.

- Model number
- Unit version

The results that are displayed in the Result Column have the following meanings.

Matched: All of the comparison items match for the Unit.

Removed: The Unit exists only in the Unit configuration in the Sysmac Studio.

Added: The Unit exists only in the actual Unit configuration.

Disabled: The Unit exists only in the Unit configuration in the Sysmac Studio and it is disabled.

Compatible: A replaceable unit whose unit version in the actual Unit configuration is later than the unit version in the Unit configuration on the Sysmac Studio.

Not compatible: A non-replaceable Unit whose unit version in the actual Unit configuration is earlier than the unit version in the Unit configuration in the Sysmac Studio.

● Transferring and Synchronizing in the Compare and Merge with Actual Unit Configuration Dialog Box

You can insert Units in the actual Unit configuration into the configuration in the Sysmac Studio. You can also adjust the Unit configuration in the Sysmac Studio to match the actual Unit configuration.

- 1** In the **Compare and Merge with Actual Unit Configuration** Dialog Box, drag a Unit in the actual Unit configuration in the comparison results onto the configuration in the Sysmac Studio. The Unit is inserted into the configuration in the Sysmac Studio.
- 2** To synchronize the entire Unit configuration, click the **Apply Actual Unit Configuration** Button. The Unit configuration in the Sysmac Studio is now the same as the actual Unit configuration.
- 3** Click the **OK** Button. This returns you to the Unit Editor.



Precautions for Correct Use

If the unit version of the Unit in the actual Unit configuration is not supported by the Sysmac Studio when you select the **Apply Actual Unit Configuration** Button, you can replace it with an earlier unit version.

However, the Unit may not operate properly depending on the unit version. In such a case, you need to update the Sysmac Studio to have the same unit version for the Unit on the Sysmac Studio and the Unit in the actual Unit configuration.



Additional Information

If the Unit in the actual Unit configuration and the Unit in the configuration in the Sysmac Studio have the same model number, but different unit versions, you can apply the unit version in the actual Unit configuration to the Unit configuration in the Sysmac Studio. Right-click in the **Compare and Merge with Actual Unit Configuration** Dialog Box and select **Apply Actual Unit Version** from the menu.

● Transferring and Comparing X Bus Unit Parameter Settings

For each X Bus Unit on the CPU Rack, you can compare the parameter settings with those in the actual Unit and transfer the settings.

- 1 Right-click a Unit in the CPU and Expansion Racks Tab Page and select **Compare parameter configurations**.

If the settings match, a comparison matched message is displayed.

- 2 To change the settings in the actual Unit to match those in the Sysmac Studio, right-click the Unit in the CPU and Expansion Racks Tab Page and select **Transfer Parameter Settings To X Bus Unit**. To change the settings in the Sysmac Studio to match those in the actual Unit, right-click the Unit in the CPU and Configuration Tab Page and select **Transfer Parameter Settings From X Bus Unit**.

The settings are transferred and the comparison results will show that they are the same. Refer to the *NX-series EtherNet/IP™ Unit User's Manual (Cat. No. W627)* for details on the setting items and values for each Unit.



Precautions for Correct Use

If you execute **Transfer Parameter Settings To X Bus Unit**, the Unit is restarted after the data is transferred. At that time, communications between the Unit and the CPU Unit will stop.

● Transferring and Comparing NX Unit Operation Settings

For each NX Unit on the CPU Rack, you can compare the Unit settings with the settings in the actual Unit and you can transfer the settings.

- 1 Right-click a Unit in the CPU and Expansion Racks Tab Page and select **Edit Unit Operation Settings**.

The Unit Operation Settings Tab Page is displayed for the selected Unit.

- 2 Click the **Compare** Button.

The settings in the actual Unit are displayed in the **Comparison Result** column.

- 3 To change the settings in the actual Unit to match those on the Sysmac Studio, click the **Transfer to Unit** Button. To change the settings on the Sysmac Studio to those in the actual Unit, click the **Transfer from Unit** Button.

The settings are transferred and the comparison results will show that they are the same.

For details on the parameters and settings for each Unit, refer to the user's manual for the specific Unit.



Precautions for Correct Use

If you execute **Transfer to Unit**, the Unit is restarted after the data is transferred. At that time, communications between the Unit and the CPU Unit will stop.

● Comparing the Unit Operation Settings for All NX Units

You can compare the operation settings for all of the mounted NX Units with respect to the actual configuration and the configuration in the Sysmac Studio.

To perform this comparison, it is required that the actual Unit configuration and the Unit configuration in the Sysmac Studio match.

- 1** Right-click a Unit in the CPU and Expansion Racks Tab Page and select **Compare operation settings of all NX Units**.

The comparison results are displayed in a dialog box.

If there are any Units whose Unit settings mismatch, the unit number and model of the Units are listed.



Additional Information

Units for which the unit mounting setting is set to Disabled are not the target of comparison.

Synchronization, Transferring, and Comparing the CPU Rack and Expansion Rack Configuration of NJ-series Controllers

These functions allow you to synchronize data between the Sysmac Studio and an NJ-series Controller through various methods. You can transfer the actual unit configuration from the NJ-series Controller to the Sysmac Studio and transfer Special Unit settings from the Sysmac Studio to the NJ-series Controller or from the NJ-series Controller to the Sysmac Studio.

● Procedure to Display the Compare and Merge with Actual Unit Configuration Dialog Box

- 1** Double-click **CPU/Expansion Racks** under **Configurations and Setup** in the Multiview Explorer. Or, right-click **CPU/Expansion Racks** under **Configurations and Setup** and select **Edit** from the menu.
The Unit Editor is displayed in the Edit Pane.
- 2** Right-click anywhere in the Unit Editor where there is no Unit and select **Compare and Merge with Actual Unit Configuration**.
The actual Unit configuration is read and compared with the Unit configuration on the Sysmac Studio. The results are displayed in the **Actual Unit Configuration Compare and Merge** Window.
- 3** Click the **Apply actual Unit configuration** Button to synchronize with the actual configuration.
- 4** Click the **OK** Button.
This returns you to the Unit Editor.



Precautions for Correct Use

If you select to unify to the actual Unit configuration, all of the settings for any Units that are deleted as a result will be discarded (including the input response times, Special Unit settings, device variable assignments in the I/O map, and control task assignments in the Task setup). If the slot position of a Basic I/O Unit is different, first correct the Unit configuration on the Sysmac Studio so that the slot positions agree in the comparison and then specify unifying to the actual Unit configuration.



Additional Information

Matched, **Unit removed**, **Unit added**, **Position changed**, and **Version not matched** are displayed in the **Result** Column to give the results of comparing the Unit configuration on the Sysmac Studio with the actual Unit configuration.

The following items are compared.

- Rack numbers
- Slot numbers
- Model numbers
- Unit versions of Special Units
- Unit numbers of Special Units

The results that are displayed in the Result Column have the following meanings.

Matched: All of the comparison items match for the Unit.

Unit removed: The Unit exists only in the Unit configuration on the Sysmac Studio.

Unit added: The Unit exists only in the actual Unit configuration.

Position changed: A Unit has the same model number, Unit version, and unit number, but the rack number or slot number is different.

Version not matched: The unit version of the Unit does not match.

● Procedure for Comparison and Transfer of the Special Unit Settings

1 Double-click a Unit in the Unit Editor, or right-click and select **Edit Special Unit Settings**. The **Edit Special Unit Settings** Tab Page for the selected Unit is displayed.

2 Click the **Compare** Button.

The parameters in the Sysmac Studio are compared with the parameters from the NJ-series Controller. If any parameters are not the same, they are indicated by “≠” in the results.

Parameter name	Parameter value	Compare results	Unit
Scan List Enabled Switch	OFF	OFF	
Scan List Clear Switch	OFF	OFF	
Remote I/O Communications Start Switch	OFF	OFF	
Remote I/O Communications Stop Switch	OFF	OFF	
Master Enabled Switch	OFF	OFF	
Master Disabled Switch	OFF	OFF	
Master Fixed Allocation Setting 1 Switch	OFF	OFF	
Master Fixed Allocation Setting 2 Switch	OFF	OFF	
Master Fixed Allocation Setting 3 Switch	OFF	OFF	
Master User-set Allocation Switch	OFF	OFF	
Temporary Setting Switch for Communications Cycle Time	OFF	OFF	
Communications Cycle Time Setting Switch	OFF	OFF	

3 To synchronize the Controller settings with the set values in the Sysmac Studio, click the **Transfer To Controller** Button. This transfers the set values from your computer to the Controller.

7-5-2 Testing Axis Operation (MC Test Run)

You can send commands directly from the Controller without any ladder diagrams to operate a motor in order to check wiring or perform simple operation tests on any OMRON Servo Drive assigned to an axis.



Precautions for Safe Use

- Confirm the axis number carefully before you perform an MC Test Run.
 - An MC Test Run operation involves motor operation. Refer to the operation manual before you execute an MC Test Run. Be particularly careful of the following points.
 - a) Confirm safety around all moving parts.
 - b) When you click the Run Button, the motor begins actual operation at the specified velocity. Only begin motor operation if you are absolutely sure there is no danger if you start the motor.
 - c) Always have an external emergency stop device available.
 - d) Sometimes you may be unable to stop the motor from your computer. Install an external emergency stop device so that you can stop the motor immediately if needed.
 - e) Only operate the motor when you can clearly confirm the motor operation so that you can react quickly in the case of any danger that may arise due to operation of the motor.
 - f) Perform test run operations after establishing EtherCAT communications.
 - g) A communications error will occur if you attempt to begin operations without EtherCAT communications. Always establish EtherCAT communications first.
 - Precautions during MC Test Run Operation
 - a) During test run execution, only the Sysmac Studio has any control of the operation. Any commands from motion control instructions are ignored.
 - b) Make sure that you are operating the correct axis.
-



Precautions for Correct Use

- Before you start an MC Test Run, make sure that the operation parameters are set correctly.
 - If you transfer the axis parameters or slave parameters to the slave during an MC Test Run from another copy of the Sysmac Studio, the MC Test Run will end when the transfer is completed and the axes will stop. This also applies if the parameters are transferred from the Sysmac Studio running on a different computer.
-

How to Perform MC Test Run

To begin a test run, the following items must be registered or set, and then transferred to the Controller. (Refer to *5-7 Motion Control Setup* on page 5-80 for detailed settings.)

- Registration of the axes
- Registration of the slave (Servo) to use
- Links between the axis and slave

You cannot start an MC Test Run in the following condition.

- When the Simulator is online
- During an MC Test Run
- During a Servo Drive Test Run

Let's look at an example that performs jogging of *MC_Axis000* to demonstrate how to do a test run.

- 1** Eliminate any building errors in the project.
If you will create a new project, delete the programs.
- 2** Go online.
- 3** Right-click **MC_Axis000** under **Configurations and Setup – Motion Control Setup – Axis Settings** on the Multiview Explorer and select **Start MC Test Run** from the menu.

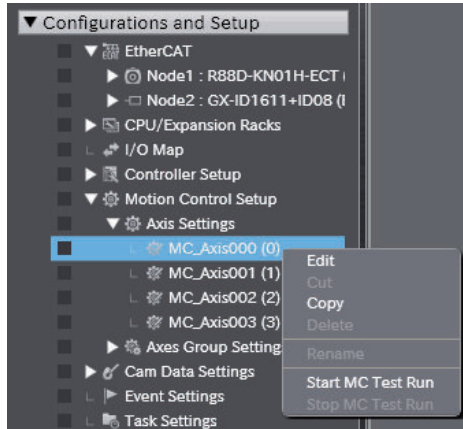

A warning message is displayed.

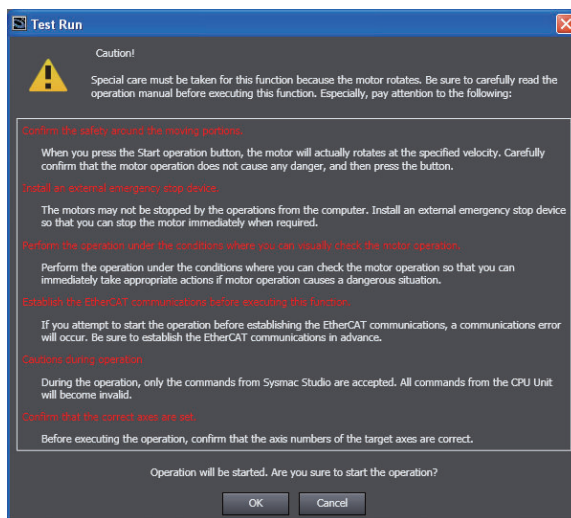

- 4** Check the items and then click the **OK** Button.
The MC Test Run Tab Page is displayed.

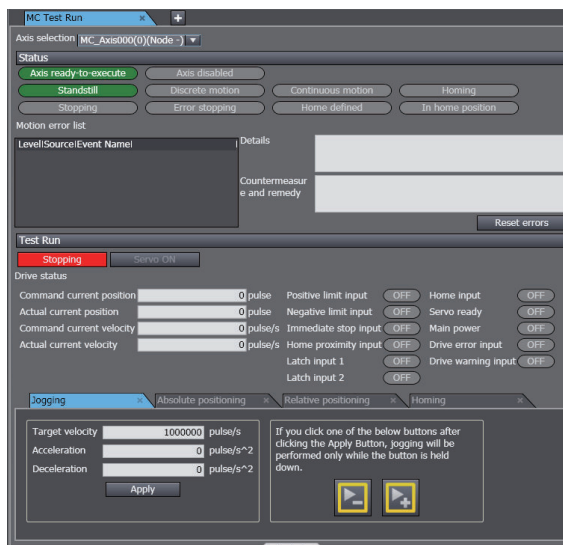

- 5** Select the target axis (*MC_Axis000*) at the upper left of the MC Test Run View.

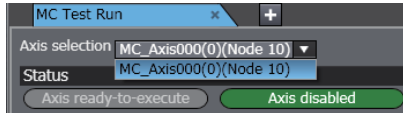

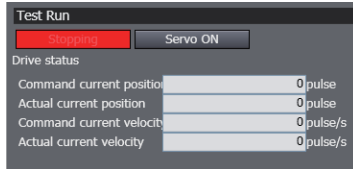

6 Click the **Servo ON** Button.



The Servo turns ON and motor control is enabled.

7 Click the **Jogging** Tab, and then perform the following operations.

- Click and hold the Rotate CW Button (). The motor rotates clockwise as long as you hold the button.
- Click and hold the Rotate CCW Button (). The motor rotates counterclockwise as long as you hold the button.

8 Right-click **MC_Axis000** under **Configurations and Setup - Motion Control Setup - Axis Settings** on the Multiview Explorer and select **Stop MC Test Run** from the menu. Test Run Mode is left.

MC Test Run Tab Page Functions

The MC Test Run View is made up of the *Status Monitor* and *Test Run* sections.

● Status Monitor Section

The status monitor displays axis status, motion errors and details on them, and corrections for any errors that have occurred. You can also reset motion control errors and start the Servo error monitor.

Function	Description
Status	Displays information about the status of an axis (ready to execute, axis disabled, stopped, in a discrete motion, in continuous motion, homing, decelerating to a stop, decelerating to a stop due to an error, home defined, and stopped at home).
Motion Error List	Displays a list of errors that have occurred in the motion control functions. The Message Details Area gives details on the error and the Countermeasure and Remedy Area contains information about how to fix the error.
Reset Errors	Resets all errors that have occurred in the motion control functions. Select an error from the list of errors that have occurred to display detailed information about that error in the Message Details Area. Possible solutions to that error can be found in the Countermeasure and Remedy Area.

● Test Run Section

A test run allows you to operate a motor using the motion control patterns listed below without any programming. You can switch between each pattern by clicking on the different tabs in this section.

Pattern	Description
Jogging	Jogs the Servomotor. This operation is only performed while the button is clicked and held.
Absolute positioning	Performs positioning towards the target position at the specified acceleration/ deceleration rate. Specify the target position as an absolute value. If the rotary counter mode is used for an axis in the test run, you can select the direction of rotation for the axis.
Relative Positioning	Performs positioning towards the target position at the specified acceleration/ deceleration rate. Specify the target position as a relative value from the actual position.
Homing	Performs homing based on the homing settings in the axis parameters.

You can use the following functions to switch between different motions for the axis in operation.

Function	Contents
Stopping Button	Decelerates the axis in operation to a stop.
Servo ON/OFF Button	Toggles the Servo ON and OFF.
Servo Drive Status	Displays connected Servo parameters.



Precautions for Safe Use

- Confirm safety around all moving parts.
When you click the Run Button, the motor begins actual operation at the specified speed. Only begin motor operation if you are absolutely sure that there is no danger if you start the motor.
- Always have an external emergency stop device available.
Sometimes you may be unable to stop the motor from your computer. Install an external emergency stop device so that you can stop the motor immediately if needed.
- Operate the motor only when the motor is in plain sight for you to observe.
Operate the motor only when you can clearly confirm the motor operation so that you can react quickly in the case of any danger that may arise due to operation of the motor.
- Perform test run operations after establishing EtherCAT communications.
A communications error will occur if you attempt to begin operations without EtherCAT communications. Always establish EtherCAT communications first.
- Be aware of all the precautions that you need to take during operation.
During test run execution, only the Sysmac Studio has any control of the operation. Any commands from motion control instructions are ignored.
- Make sure that you are operating the correct axis.
Before you start any tests, make sure that the axis number of the axis that you are controlling is correct.

7-5-3 Checking I/O Wiring

● Checking I/O Wiring

You can check I/O wiring to make sure that I/O devices, such as Units on the CPU Rack, EtherCAT slaves, and Units on the Slave Terminals, are connected properly with external devices.

● Procedure to Check I/O Wiring

- 1 Go online and then double-click **I/O Map** under **Configurations and Setup** in the Multiview Explorer. Or, right-click I/O Map under Configurations and Setup and select **Edit** from the menu.

Pod	Port	Description	R/W	Data Type	Value	Variable
CF	CPU/Expansion Racks					
	CPU Rack 0					
	CJ1W-DA041 (Analog Output U					
	Ch1_WrAO	Output 1 Set Value	RW	INT	0	J01_Ch1_WrAO
	Ch2_WrAO	Output 2 Set Value	RW	INT	0	J01_Ch2_WrAO
	Ch3_WrAO	Output 3 Set Value	RW	INT	0	J01_Ch3_WrAO
	Ch4_WrAO	Output 4 Set Value	RW	INT	0	J01_Ch4_WrAO
	ConvCmd	Conversion Enable Setting	RW	WORD	16#1	J01_ConvCmd
	Ch1_ConvCmd	Output 1 Conversion Enable	RW	BOOL	TRUE	LED
	Ch2_ConvCmd	Output 2 Conversion Enable	RW	BOOL	FALSE	J01_Ch2_ConvCmd
	Ch3_ConvCmd	Output 3 Conversion Enable	RW	BOOL	FALSE	J01_Ch3_ConvCmd
	Ch4_ConvCmd	Output 4 Conversion Enable	RW	BOOL	FALSE	J01_Ch4_ConvCmd
	MVErr	Output Set Value Error	R	BYTE	16#0	J01_MVErr
	Ch1_MVErr	Output 1 Output Set Value Error	R	BOOL	FALSE	J01_Ch1_MVErr
	Ch2_MVErr	Output 2 Output Set Value Error	R	BOOL	FALSE	J01_Ch2_MVErr
	Ch3_MVErr	Output 3 Output Set Value Error	R	BOOL	FALSE	J01_Ch3_MVErr
	Ch4_MVErr	Output 4 Output Set Value Error	R	BOOL	FALSE	J01_Ch4_MVErr
	UnitErr	Error Flags	R	BYTE	16#0	J01_UnitErr
	HdErr	Output Hold Setting Error	R	BOOL	FALSE	J01_HdErr
	AdjCh	Outputs to Be Adjusted	RW	BYTE	16#1	J01_AdjCh
	AdjOfs	Offset Flag	RW	BOOL	FALSE	PB1
	AdjGain	Gain Flag	RW	BOOL	FALSE	J01_AdjGain

- 2 In the I/O Map, perform operations such as Set/Reset, present value change, and forced refreshing on output devices. Refer to 7-2-3 *Changing Present Values and Set/Reset Using Forced Refreshing* on page 7-24 for the procedures to execute Set/Reset, present value change, and forced refreshing in the I/O Map.
The results of the operations that you performed are input to external devices. Make sure that the operation results are input correctly to the intended external device. If the results are not input correctly, review the wiring connection between the device and the external device.
- 3 Check the input results from external devices that are connected to input devices.
The values of the corresponding devices on the I/O Map are changed. Make sure that the value of the intended device is changed correctly. If the value is not changed correctly, review the wiring connection between the device and the external device. Refer to 7-2-1 *Monitoring* on page 7-4 for details on monitoring in the I/O Map.

7-5-4 Checking I/O Assignments

● Checking I/O Assignments

You can use an I/O assignment check to check the assignments of external I/O devices and variables.

● Procedure to Check I/O Assignments

- 1 Execute a wiring connection check between Units and external devices.
- 2 Open the Watch Tab Page while online.

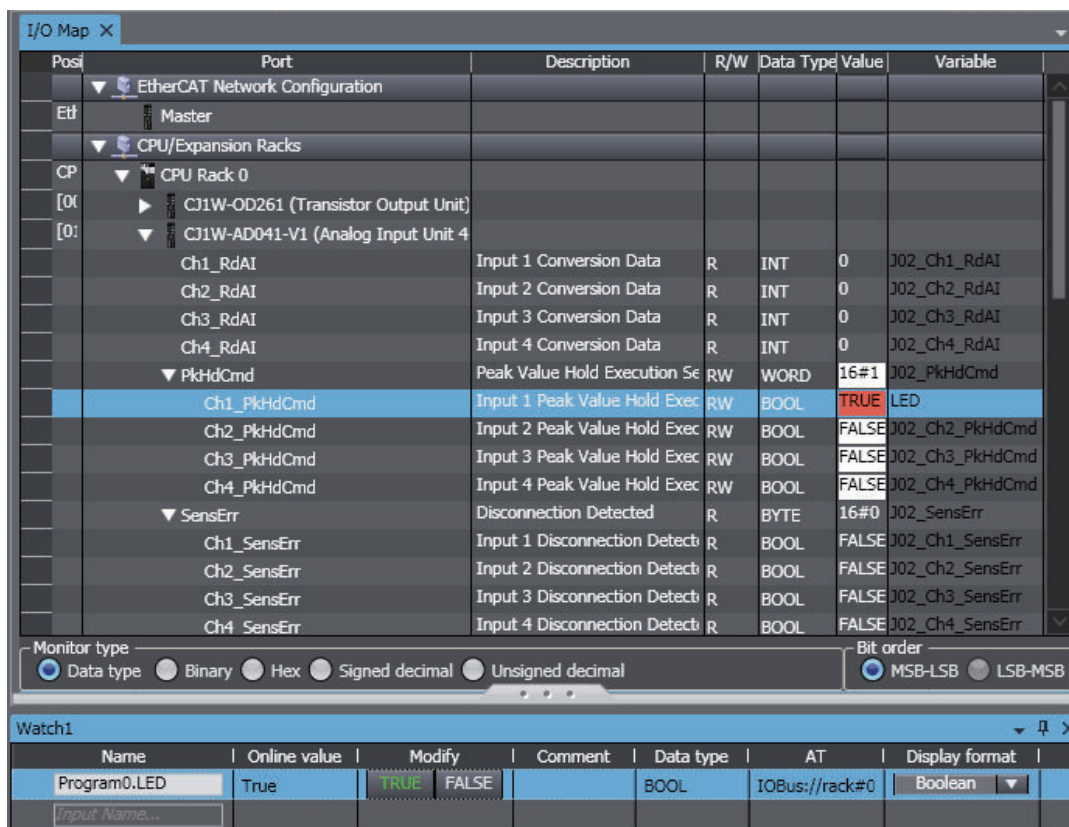

- 3 In the Watch Tab Page, register the variables that are assigned to output devices. Refer to *7-2-1 Monitoring* on page 7-4 for details on the procedure to register variables in the Watch Tab Page.
- 4 Perform operations such as Set/Reset, present value change, and forced refreshing on variables that you registered in the Watch Tab Page. Refer to *7-2-3 Changing Present Values and Set/Reset Using Forced Refreshing* on page 7-24 for the procedures to execute Set/Reset, present value change, and forced refreshing in the Watch Tab Page.
The results of the operations that you performed are input to external devices. Make sure that the operation results are input correctly to the intended external device. If the results are not input correctly, review the variable assignments to the device.
- 5 In the Watch Tab Page, register the variables that are assigned to input devices.
- 6 Check the input results from external devices that are connected to input devices.
The values of variables that you registered in the Watch Tab Page are changed. Make sure that the variable values are changed correctly. If the values are not changed correctly, review the variable assignments to the device. Refer to *7-2-1 Monitoring* on page 7-4 for details on monitoring in the Watch Tab Page.

7-5-5 Resetting the Controller

A Controller reset emulates the operations and status when the power supply to the Controller is cycled.

This can be performed only in PROGRAM Mode. You cannot reset the Controller in RUN Mode.

You also cannot reset the Controller when connected to the Simulator.

● Procedure

- 1 Select **Reset Controller** from the **Controller Menu**.
A confirmation dialog box is displayed.

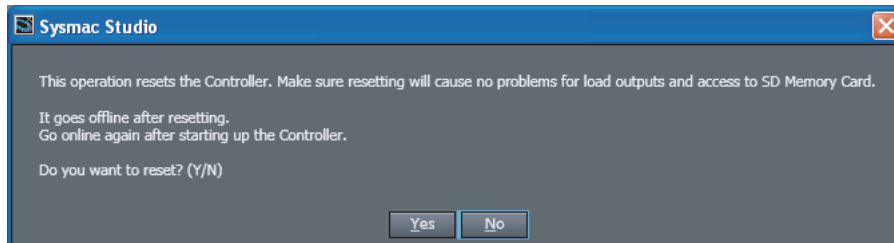

- 2 Confirm that no problem will occur even if you reset the Controller, and then click the **Yes** Button.



Precautions for Safe Use

- Always confirm safety before you reset the Controller.
- Always confirm the safety of the system before you reset Controller.
- It takes up to approximately 10 to 20 s to enter RUN mode after the power is turned ON. During that period, the outputs behave according to the slave and Unit specifications. Use the RUN output on the Power Supply Unit, for example, to implement fail-safe circuits so that external devices do not operate incorrectly.



Additional Information

After a reset is performed, the Sysmac Studio goes offline.

7-5-6 Restarting Units

Use the following procedure to restart Units.

If you change operation settings for an NX Unit or CJ-series Unit, it may be necessary to restart the Unit depending on the changes.

Restart an NX Unit

- 1 Right-click a Unit and select **Restart for NX Bus/NX Unit** from the menu.
A restart confirmation dialog box is displayed.
- 2 Click the **Yes** Button.
The Unit is restarted.



Additional Information

- If NX Units are mounted on an NX102 or NX1P2 CPU Unit, right-clicking the CPU Unit and then selecting **Restart for NX Bus/NX Unit**, all the NX Units mounted on the CPU Unit are restarted.
 - Refer to *8-13-4 Maintenance Operations for EtherCAT Slave Terminals* on page 8-99 for details on restarting NX Units on an EtherCAT Slave Terminal.
-

Restarting CJ-series Special Units

You can restart CJ-series Special Units by using the restart instruction in the user program. Some CJ-series Special Units can be restarted from the Sysmac Studio.

- 1** Right-click a Unit and select **Edit Special Unit Settings** from the menu.
The Special Unit Settings Tab Page is displayed.
- 2** Click the **Restart** Button.



Additional Information

Refer to the *NJ/NX-series CPU Unit Software User's Manual (Cat. No. W501)* for details on using the restart instruction in the user program.

8

Other Functions

This section describes Sysmac Studio functions other than system design functions.

8-1	SD Memory Card Operations	8-4
8-1-1	SD Memory Card Window Procedures	8-4
8-2	Clock Information Settings.....	8-8
8-3	Security Settings	8-9
8-3-1	Secure Communications Setting	8-9
8-3-2	Operation Authority Verification	8-11
8-3-3	User Authentication	8-19
8-3-4	Authentication of User Program Execution IDs	8-34
8-3-5	Write Protection of the CPU Unit	8-37
8-3-6	Data Protection.....	8-39
8-3-7	Secure Socket Settings	8-45
8-4	User Memory Usage Monitor	8-49
8-5	Printing.....	8-52
8-5-1	Items You Can Print.....	8-52
8-5-2	Print Setup.....	8-52
8-5-3	Printing	8-55
8-5-4	Print Preview	8-56
8-6	Clearing Memory	8-58
8-6-1	Clearing All Memory of the CPU Unit	8-58
8-6-2	Clearing All Memory of X Bus Units	8-60
8-6-3	Clearing All Memory of NX Units	8-61
8-6-4	Clear All Memory Operation for the Units in a Slave Terminal	8-62
8-7	Releasing Access Rights	8-64
8-8	Displaying Unit Production Information	8-65
8-8-1	Displaying CPU Unit Production Information.....	8-65
8-8-2	Displaying EtherCAT Slave Production Information	8-67
8-8-3	Displaying Production Information for Configuration Units in Ether-CAT Slave Terminals	8-67
8-9	Firmware Update Log	8-69
8-10	Backup Functions	8-70
8-10-1	Controller Backup Functions	8-71
8-10-2	SD Memory Card Backup Functions	8-75
8-10-3	Backing Up Variables and Memory	8-76
8-10-4	Importing/Exporting Backup Files.....	8-84
8-11	Transferring All Controller Data.....	8-88

8-11-1	Transferring Data from the Computer to a Controller	8-88
8-11-2	Transferring Data from the Controller to the Computer	8-88
8-12	NX Unit Maintenance	8-90
8-13	EtherCAT Maintenance	8-91
8-13-1	Disconnecting a Slave from and Reconnecting a Slave to the Network	8-91
8-13-2	Packet Monitoring.....	8-93
8-13-3	Diagnostic and Statistical Information	8-94
8-13-4	Maintenance Operations for EtherCAT Slave Terminals	8-99
8-14	Grouping for POUs and Global Variables	8-101
8-14-1	Displaying the Programming Group Tab Page	8-101
8-14-2	Grouping POUs	8-102
8-14-3	Grouping Global Variables	8-105
8-15	Project Shortcut View	8-109
8-15-1	Displaying the Project Shortcut View	8-109
8-15-2	Adding User Folders.....	8-110
8-15-3	Renaming User Folders	8-111
8-15-4	Copying and Pasting User Folders.....	8-111
8-15-5	Cutting User Folders	8-112
8-15-6	Deleting User Folders.....	8-112
8-15-7	Editing Comments on User Folders	8-113
8-15-8	Adding Shortcuts	8-113
8-15-9	Editing Items from Shortcuts	8-115
8-15-10	Copying and Pasting Shortcuts	8-116
8-15-11	Cutting Shortcuts.....	8-117
8-15-12	Deleting Shortcuts	8-117
8-15-13	Editing Comments on Shortcuts.....	8-118
8-15-14	Jumping from a Shortcut to the Multiview Explorer	8-118
8-16	Troubleshooting	8-120
8-16-1	Troubleshooting Dialog Box.....	8-120
8-16-2	Controller Errors	8-121
8-16-3	Controller Event Log.....	8-125
8-16-4	User-defined Errors	8-129
8-16-5	User-defined Event Log.....	8-130
8-16-6	Event Setting Table	8-131
8-16-7	Displaying and Editing the Event Setting Table.....	8-133
8-16-8	Exporting the Event Setting Table	8-136
8-16-9	Event Log Viewer	8-137
8-17	Changing Variable Comments and Data Type Comments	8-140
8-17-1	Exporting Comments	8-140
8-17-2	Editing the Comment File	8-140
8-17-3	Importing Comment Files	8-141
8-17-4	Switching the Displayed Comments.....	8-142
8-17-5	Procedure to Edit Switchable Comments in Variable Tables.....	8-143
8-18	Exporting the Program Hash Code.....	8-146
8-19	Exporting Global Variables	8-148
8-19-1	Exporting Global Variables for the Network Configurator	8-148
8-19-2	Exporting Global Variables for the CX-Designer	8-148
8-20	Importing ST Programs	8-149
8-21	Importing IEC 61131-10 XML Files	8-151
8-21-1	Importing Data.....	8-151
8-21-2	Compare before Importing	8-152
8-22	Importing IEC-62714 AutomationML Files	8-155
8-22-1	Importing Data.....	8-156
8-22-2	Comparison Results of Controller Configurations	8-159
8-22-3	Resolving Conflicts between Device Variables	8-161
8-23	Importing Motor Sizing Tool Results.....	8-162
8-24	Updating the Configurations and Setup Transfer Data	8-164

8-25	EtherNet/IP Connection Settings	8-165
8-26	Sysmac Studio Option Settings	8-166
8-26-1	Option Settings	8-166
8-26-2	Exporting and Importing Option Settings	8-174

8-1 SD Memory Card Operations

● SD Memory Card Operations

The SD Memory Card function is provided so that you can operate files in an SD Memory Card that is mounted in the NJ/NX-series Controller and transfer and copy files between the SD Memory Card and the computer.

With an NY-series Controller, a Virtual SD Memory Card is used to perform the same function as an SD Memory Card. In the following description, an SD Memory Card should be replaced by a Virtual SD Memory Card when you use an NY-series Controller.

8-1-1 SD Memory Card Window Procedures

- 1 Select **SD Memory Card** from the **Controller** Menu when online. The SD Memory Card Window is displayed.

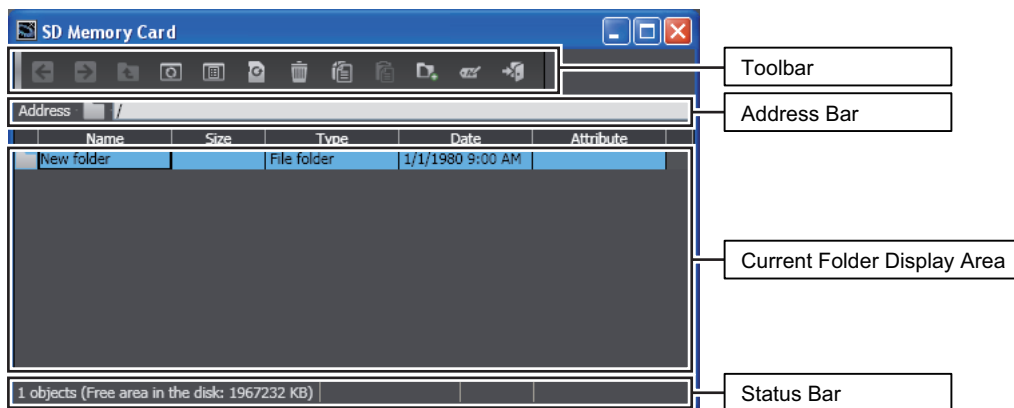









Overview of the SD Memory Card Window

● Toolbar

Use the buttons in the toolbar or shortcut keys to execute SD Memory Card file operations.

Button	Operation (shortcut)	Function
	Back (Alt + ←)	Returns to previous file or folder.
	Forward (Alt + →)	Goes forward to next file or folder.
	Up (Backspace)	Goes to one higher folder.
	Update (F5)	Updates the display to the latest information.
	Properties (Alt + Enter)	Used to display the properties and change the attributes* ¹ of the selected file or folder (cannot be used when no file or folder is selected or when more than one file or folder is selected).
	Initialize SD Memory Card* ² (Ctrl + Alt + A)	Formats the SD Memory Card.

Button	Operation (shortcut)	Function
	Delete (Del)	Deletes the selected files or folders.
	Copy (Ctrl + C)	Copies the selected files or folders.
	Paste (Ctrl + V)	Pastes the copied files or folders.
	New Folder (Ctrl + Alt + F)	Creates a new folder in the current location.
	Rename (F2)	Changes the name of the selected file or folder (cannot be used when no file or folder is selected or when more than one file or folder is selected).
	SD Memory Card Backup (Alt + Shift + B) *3	Backs up the Controller data in the SD Memory Card.
	Compare SD Memory Card Backup (Alt + Shift + C) *3	Compares the data in a backup file in the SD Memory Card to the Controller data.
	Exit (Alt + F4)	Ends SD Memory Card operations.

*1. You cannot change the attribute for an NY-series Controller.

*2. You cannot use the operation for an NY-series Controller. The button is grayed out.

*3. Refer to *8-10-2 SD Memory Card Backup Functions* on page 8-75 for the procedures for the SD Memory Card backup functions.

● Address Bar

The address bar displays the current folder on the SD Memory Card. You can also specify the folder you need.

● Current Folder Display Area

This area displays a list of the files in the current folder on the SD Memory Card. The following items are displayed. Click a title to sort the files by that item.

Title	Description
Name	File/folder name (long file names)
Size	Actual file size (Kbytes)
Type	Type of file registered on the computer
Date	Time and date the file was modified
Attribute	R: Read only

● Status Bar

The status bar displays information on the files in the current folder on the SD Memory Card. The following items are displayed.

Item	Description
Status	Number of objects in the file list (number of files and folders) Note SD Memory Card is not mounted or not formatted is displayed if an SD Memory Card is not inserted, power is not supplied to the SD Memory Card, or the SD Memory Card is not formatted.
Volume Label	The volume label of the SD Memory Card*1
Free Area	The size of free area in the SD Memory Card (KB)

*1. The volume label is not displayed for an NY-series Controller.

SD Memory Card Procedures

● Formatting an SD Memory Card

- 1 Click the Format Button ().
A confirmation dialog box is displayed.

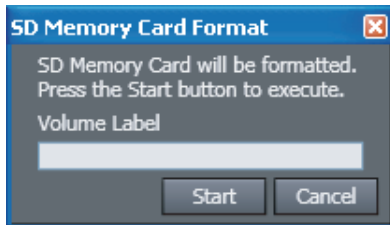

- 2 Click the **Start** Button.

● Displaying Properties

- 1 Select the file or folder.
- 2 Click the Properties Button ().
The properties of the selected file or folder are displayed.

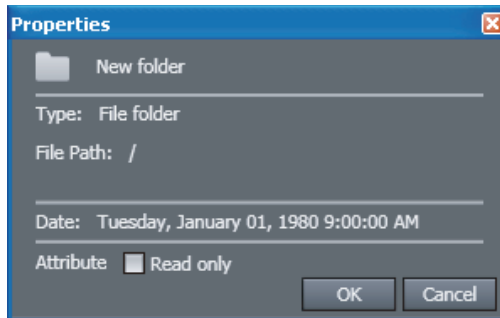

When a Folder Is Selected

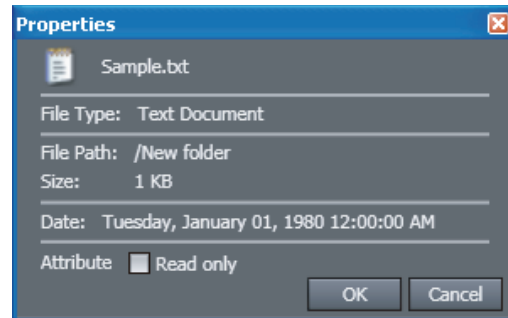

When a File Is Selected



● Copying Files and Folders in the SD Memory Card

- 1 Select files or folders and click the Copy Button ().
- 2 Specify the copy destination, and then click the Paste Button ().
The selected files or folders are copied.

● Copying Files and Folders from the SD Memory Card to the Computer

- 1 Select files or folders in the SD Memory Card Window, and then click the Copy Button ().

- 2 Specify the copy destination in Windows Explorer, and then paste the files or folders (Ctrl + v).
The selected files or folders are pasted.

● Copying Files and Folders from the Computer to the SD Memory Card

- 1 Select and copy files or folders in Windows Explorer (Ctrl + c).
- 2 Specify the copy destination in the SD Memory Card Window, and then click the Paste Button .
The selected files or folders are pasted.



Precautions for Correct Use

- Multibyte characters (e.g., Japanese) cannot be used in the CPU Unit even if they can be used on the computer.
 - You can create up to 511 files in the root directory.
You cannot create this many files if you use MS-DOS 8.3 file names or long file names.
-

8-2 Clock Information Settings

The computer's clock information is also displayed. You can read and set the Controller's clock.

● Displaying and Setting Clock Information

This function can be used only online.

- 1 Select **Controller Clock** from the **Controller** Menu of the Sysmac Studio.

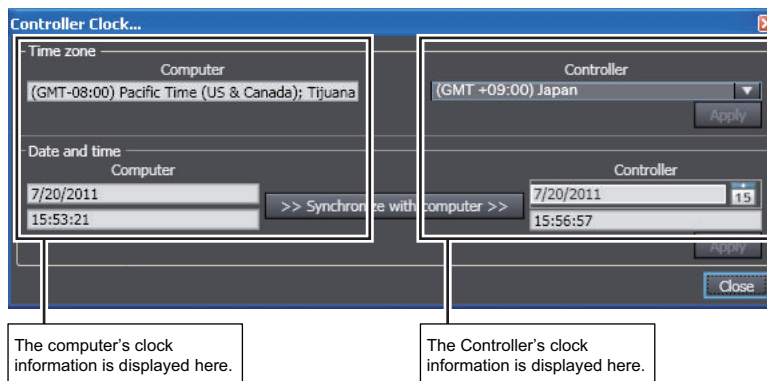

- 2 To set the time zone, select the time zone of the Controller and click the **Apply** Button for the time zone.
- 3 To set the clock in the Controller, set the clock information for the Controller and then click the **Apply** Button for the date and time. Click the **Synchronize with computer** Button and then click the **Apply** Button to synchronize the Controller's clock information with the computer's clock information.



Precautions for Correct Use

With an NY-series Controller, you cannot set the time zone and apply the clock information of the computer to the Controller. Refer to the *NY-series Industrial Panel PC / Industrial Box PC Software User's Manual (Cat. No. W558)* for details on the clock function of the NY-series Controller.

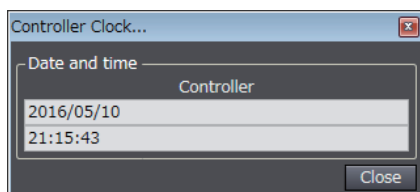

8-3 Security Settings

To protect assets and prevent incorrect operation, you can protect user programs and data in the Controller and restrict operations in the Sysmac Studio.

● Overview of Security Settings

An overview of the applications and functions of security settings is given below.

Function	Application	Outline of function
Secure communications setting	Securing of data confidentiality and integrity	Secure communications prevent third parties from sniffing and falsifying communications data between the Sysmac Studio and the Controller. This function sets the protection level of the secure communications.
Operation authority verification	Prevention of incorrect operation	This limits the operations that each operator can use based on the authority of the operator.
User authentication	Prevention of the theft of assets/ Prevention of incorrect operation	This authenticates each user who attempts to go online by username and password to identify the user who performs online operations.
User program execution ID	Prevention of the theft of assets	This ensures that a user program cannot be operated on another CPU Unit even if copied.
Write protection of the CPU Unit	Prevention of incorrect operation	You can prevent the Sysmac Studio from overwriting data in the CPU Unit.
Data protection	Prevention of the theft of assets	You can set passwords for individual POU's (programs, functions, and function block definitions) and cam profiles to prevent them from being displayed, changed, or copied.
Secure socket settings	Prevention of the theft of assets	This function configures the settings required to perform secure socket communications that are encrypted using TLS (Transport Layer Security).

8-3-1 Secure Communications Setting

Secure communications prevent third parties from sniffing and falsifying communications data between the Sysmac Studio and the Controller by encrypting the data and adding a hash value to it before sending and receiving. You can set the protection level of the secure communications by specifying **Secure Communication Version** in the Secure Communications Setting Dialog Box.

To use secure communications, one of the following combinations of the CPU Unit's unit version and the Sysmac Studio version is required.

For unit versions that support Secure Communication Version 2, you can set whether to use Secure Communication Version 1 or Secure Communication Version 2. Select an appropriate Secure Communication Version according to your operation.

Secure communications	NJ-series, NX102, or NX1P2 CPU Unit	NX502 CPU Unit	NX701 CPU Unit	Sysmac Studio version
Secure Communication Version setting supported (Secure Communication Versions 1 and 2 are supported)	Version 1.69 or later	Version 1.69 or later	Version 1.36 or later	Version 1.63 or higher
Secure Communication Version setting not supported (Operates as Secure Communication Version 1)	Version 1.49 to 1.68	Version 1.60 to 1.68	Version 1.29 to 1.35	Version 1.50 to 1.62
Secure communications is not supported	Version 1.48 or earlier	Version 1.59 or earlier	Version 1.28 or earlier	Version 1.49 or lower

The secure communications function is enabled/disabled depending on the DIP switch setting of the CPU Unit, *allow Sysmac Studio or NA connection not supporting secure communication*. Refer to the *NJ/NX-series CPU Unit Software User's Manual (Cat. No. W501)* for details.

Sysmac Studio Versions That Support Secure Communication Version Setting

Secure Communication Version	Sysmac Studio version
Secure Communication Version setting supported (Secure Communication Versions 1 and 2 are supported)	Version 1.63 or higher
Secure Communication Version setting not supported	Version 1.62 or lower

Procedure for Secure Communication Version Setting

- 1 Select **Security – Secure Communications Setting** from the **Controller Menu**. The **Secure Communications Setting** Dialog Box is displayed.

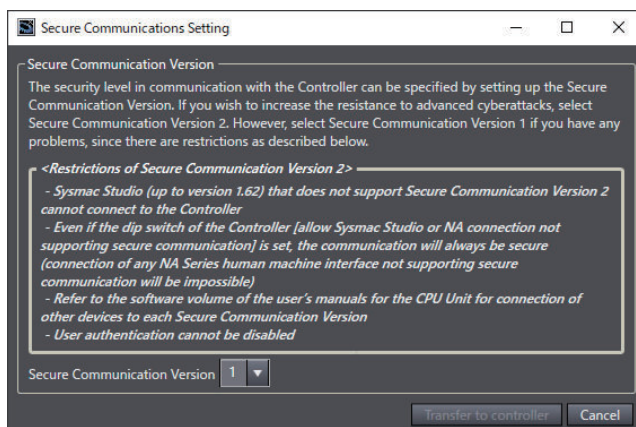

In the **Secure Communications Setting** Dialog Box, select a **Secure Communication Version** and click the **Transfer to controller** Button.

- 2 A **Secure Communication Version** change confirmation message is displayed. Click the **Yes** Button.

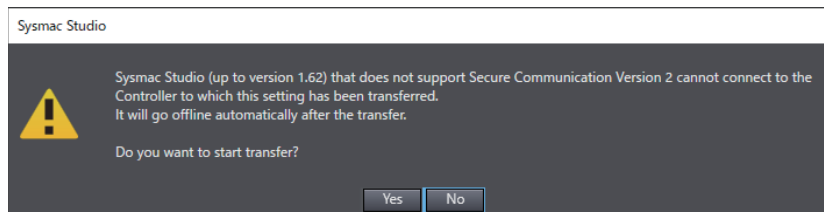

- 3 A dialog box is displayed to confirm that the Secure Communication Version setting has been completed.

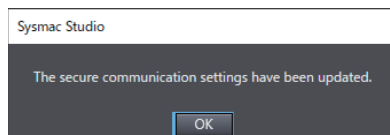

Click the **OK** Button.



Additional Information

If user authentication is set to *Enable*, the **Authentication** Dialog Box is displayed in step 1 above.

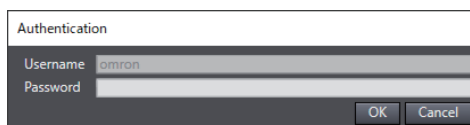

Enter the password of *Administrator* authenticated when you went online, and click the **OK** Button. Then, the **Secure Communications Setting** Dialog Box is displayed.

8-3-2 Operation Authority Verification

If you change the data in the Controller, operating errors may cause human injury or physical damage. You can restrict the operations that each operator can perform based on the authority of the operator to prevent operating mistakes.

Operation Authority Verification

● Operation Authority Verification

You can restrict online operations with operation rights to prevent damage to equipment or injuries that may be caused by operating mistakes.

An operation authority password is required to go online. If you pass password verification, you can perform online operations according to your operation authority.

The Administrator sets a password for each operation authority. Users are notified of the operation authority name and password according to their skills.

Verification of operation authority is performed when you access the Controller from another computer, because the Operation Authority Verification Settings are transferred to the Controller and stored there.



Precautions for Correct Use

- You can set operation authority verification only online.
 - Only the Administrator can change operation authority verification or transfer it to the Controller.
 - You cannot go online if you forget the operation authority password. Manage the password in case you forget it.
-

● **Types of Operation Authorities**

There are five levels of operation authority for the Sysmac Studio, as given below (in order starting with the greatest level of authority).

- Administrator
- Designer
- Maintainer
- Operator
- Observer (A password is not required.)

● Applicable Online Operations

The functions, authorities, and operation restrictions that require authentication are given below.

Supported: Operation possible, VR: Verification required for each operation, NP: Operation not possible

Monitoring status	Admin- istrator	Design- er	Main- tainer	Opera- tor	Observ- er
Controller status	Support- ed	Support- ed	Support- ed	Support- ed	Support- ed
Statuses of Special I/O Units and slaves	Support- ed	Support- ed	Support- ed	Support- ed	Support- ed
Troubleshooting and event logs	Support- ed	Support- ed	Support- ed	Support- ed	Support- ed
Reading CPU Unit names	Support- ed	Support- ed	Support- ed	Support- ed	Support- ed

Operations to monitor I/O	Admin- istrator	Design- er	Main- tainer	Opera- tor	Observ- er
Reading I/O	Support- ed	Support- ed	Support- ed	Support- ed	NP
Writing I/O	Support- ed	Support- ed	Support- ed	VR	NP
Set/Reset	Support- ed	Support- ed	Support- ed	VR	NP
Forced refreshing (TRUE/FALSE/Clear)	Support- ed	Support- ed	Support- ed	NP	NP
Monitoring programs, functions, and function blocks Differential monitoring	Support- ed	Support- ed	Support- ed	Support- ed	NP

Controller operations	Admin- istrator	Design- er	Main- tainer	Opera- tor	Observ- er
RUN mode	Support- ed	Support- ed	VR	NP	NP
PROGRAM mode	Support- ed	Support- ed	VR	NP	NP
Online editing	Support- ed	Support- ed	VR	NP	NP
Data trace operations (starting, stopping, forcing triggers, and uploading set- tings)	Support- ed	Support- ed	Support- ed	Support- ed	NP
Releasing access rights	Support- ed	Support- ed	NP	NP	NP
Clearing all memory	Support- ed	NP	NP	NP	NP
Resetting the Controller	Support- ed	Support- ed	NP	NP	NP
Resetting errors (troubleshooting)	Support- ed	Support- ed	Support- ed	VR	NP
Clearing event logs (error logs)	Support- ed	Support- ed	Support- ed	NP	NP

Controller operations	Administrator	Designer	Maintainer	Operator	Observer
Controller clock	Supported	Supported	NP	NP	NP
SD Memory Card operations	Supported	Supported	Supported	Supported	NP
Updating CPU Unit names	Supported	Supported	NP	NP	NP
Setting user program execution IDs	Supported	NP	NP	NP	NP
Setting write protection of the CPU Unit	Supported	Supported	Supported	NP	NP
MC Test Run	Supported	Supported	VR	NP	NP
Restarting CJ-series EtherNet/IP Units	Supported	Supported	Supported	NP	NP

Transfer operations	Administrator	Designer	Maintainer	Operator	Observer
Synchronization Note: Uploading and downloading are supported (including transferring only part of a project)	Supported	Supported	Supported	NP	NP
Transferring parameter settings of a CJ-series Unit mounted on the CPU/Expansion Rack to the Controller	Supported	Supported	Supported	NP	NP
Transferring parameter settings of a CJ-series Unit mounted on the CPU/Expansion Rack from the Controller	Supported	Supported	Supported	NP	NP
Transferring operation settings of an NX Unit mounted on the CPU/Expansion Rack to the Controller	Supported	Supported	Supported	NP	NP
Transferring operation settings of an NX Unit mounted on the CPU/Expansion Rack from the Controller	Supported	Supported	Supported	NP	NP
Transferring data to the Controller from the EtherCAT Configuration Display Tab Page	Supported	Supported	Supported	NP	NP
Transferring data from the Controller to the EtherCAT Configuration Display Tab Page	Supported	Supported	Supported	NP	NP
Transferring data to the Controller from the Slave Terminal Unit Settings	Supported	Supported	Supported	NP	NP
Transferring data from the Controller to the Slave Terminal Unit Settings	Supported	Supported	Supported	NP	NP
Writing the setting of the Setting Change during RUN Mode parameter in the Controller Setup	Supported	Supported	Supported	NP	NP
Transferring operation authority verification settings	VR	NP	NP	NP	NP
Transferring user account settings	VR	NP	NP	NP	NP
Showing user account list	Supported	Supported	Supported	NP	NP
Secure Socket Settings	VR	NP	NP	NP	NP

Transfer operations	Administrator	Designer	Maintainer	Operator	Observer
Transferring the Secure Communications Setting	Supported	NP	NP	NP	NP

Backup and restore operations	Administrator	Designer	Maintainer	Operator	Observer
Backing up and restoring Controller data and comparing data with Controller data	Supported	Supported	Supported	NP	NP
Backing up data to SD Memory Card and comparing data with data in SD Memory Card	Supported	Supported	Supported	NP	NP
Backing up variables and memory	Supported	Supported	Supported	NP	NP
Restoring variables and memory	Supported	Supported	NP	NP	NP

Slave Terminal operations	Administrator	Designer	Maintainer	Operator	Observer
Clearing all memory	Supported	Supported	Supported	NP	NP
Restarting	Supported	Supported	Supported	NP	NP
User calibration (Analog I/O Unit)	Supported	Supported	Supported	NP	NP

CPU Rack operations (X Bus)	Administrator	Designer	Maintainer	Operator	Observer
Clearing All Memory of X Bus Units	Supported	Supported	Supported	NP	NP
Transferring parameter settings to X Bus Unit	Supported	Supported	Supported	NP	NP
Transferring parameter settings from X Bus Unit	Supported	Supported	Supported	NP	NP

CPU Rack operations (NX Bus)	Administrator	Designer	Maintainer	Operator	Observer
Clearing All Memory of NX Units	Supported	Supported	Supported	NP	NP
Restarting NX Bus or NX Unit	Supported	Supported	Supported	NP	NP
User calibration (NX Analog I/O Unit)	Supported	Supported	Supported	NP	NP

● Password Requirements

Item	Description
Password length	Minimum 8 characters and maximum 32 characters
Usable characters	Single-byte alphanumeric characters (case sensitive)

● Procedure for Setting New Authorities

- 1 Select **Security - Setting of Operation Authority** from the **Controller** Menu.
The **Setting of Operation Authority** Dialog Box is displayed.

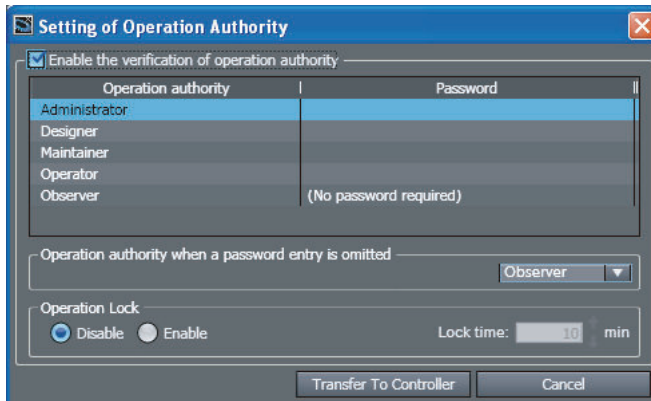

- 2 Select the **Enable the verification of operation authority** Check Box and double-click **Administrator** in the Operation authority Column.

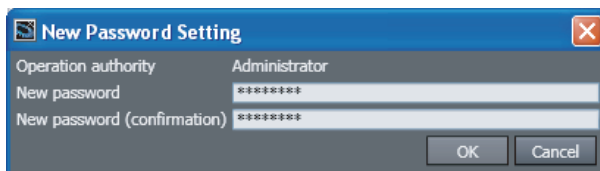

- 3 Enter the Administrator's password in the **New password** textbox. Enter the same password in the confirmation field, and click the **OK** Button.
- 4 Set the default operation authority to use when the password is not entered.
The operation authority that is set here is used when entering the password is omitted during verification when going online.
- 5 Set the password for the operation authority to set.
A password is required for operations that require a higher operation authority than the operation authority that is set for when the password is not entered.
A password is not required for operations that require an operation authority that is equal to or less than the operation authority that is set for when the password is not entered. Leave the password entry box blank.
- 6 Click the **Transfer To Controller** Button to write the settings into the Controller.
A dialog box for completion of setting operation authority verification is displayed.

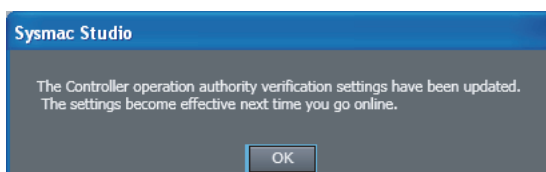

To enable the settings, go online with the Controller again.

● Procedure for Changing Authority Verification Settings

You cannot change authority verification settings unless you are the Administrator.

- 1 Select **Security - Setting of Operation Authority** from the **Controller** Menu.
The Administrator Authentication Dialog Box is displayed.

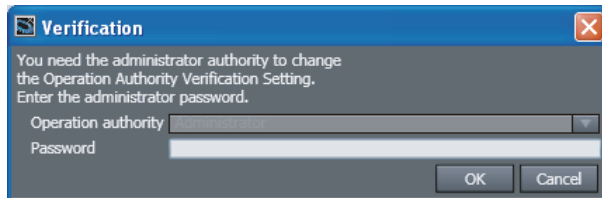

- 2 Enter the Administrator's password, and click the **OK** Button.
- 3 Use the same procedure as for a new password to set the password in the **Setting of Operation Authority** Dialog Box.

Verification When Going Online

When operation authority verification is set on the Controller, operation authority verification is performed when going online.

If verified, you can perform online operations according to your authority.

● Procedure for the Verification Dialog Box

The **Verification** Dialog Box is displayed when you attempt to go online.

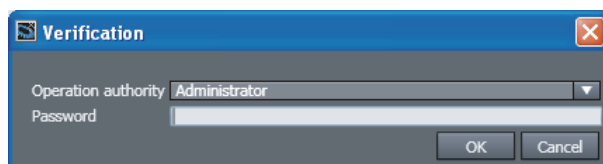

- 1 Select the operation authority, enter the password, and click the **OK** Button.
If the password is correct, online operations are enabled.
If you cancel password entry or do not enter a password, the default operation authority will apply to online operations.
The following warning is displayed if the password does not match. Click the **OK** Button and then either continue with operations or go online again.
Click the **OK** Button to go online as an *Observer*.

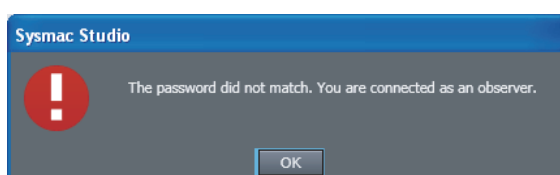

Verification for Individual Operations

Verification is performed each time a user with a certain authority or lower performs an operation that may damage equipment or cause injury due to incorrect operation.

Refer to *Applicable Online Operations* on page 8-13 for information on the applicable operations.

Be careful when you enter the password in the Verification Dialog Box. The Sysmac Studio is locked for 10 minutes if you enter the wrong password 5 times.

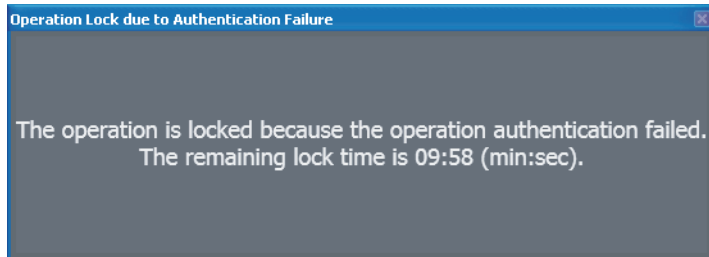

If you select an operation that cannot be used with the current authority, the following error message is displayed and the operation is not performed.

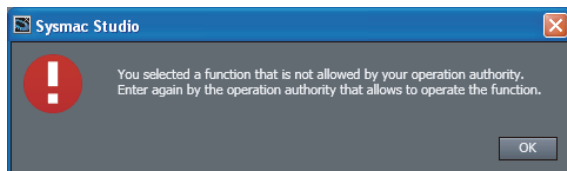

Go online again and change the operation authority before you perform the operation.

Operation Lock

You can set a lock on verification to prevent user operations if there are no user operations for the time that is specified in the **Setting of Operation Authority** Dialog Box.

This prevents the wrong user from mistakenly performing operations. If operation is locked, you need to perform verification again.

Operation authority must be set to use the operation lock. It cannot be used alone.

● Procedure to Set the Operation Lock

- 1 Select **Setting of Operation Authority** from the **Controller** Menu.
The **Setting of Operation Authority** Dialog Box is displayed.

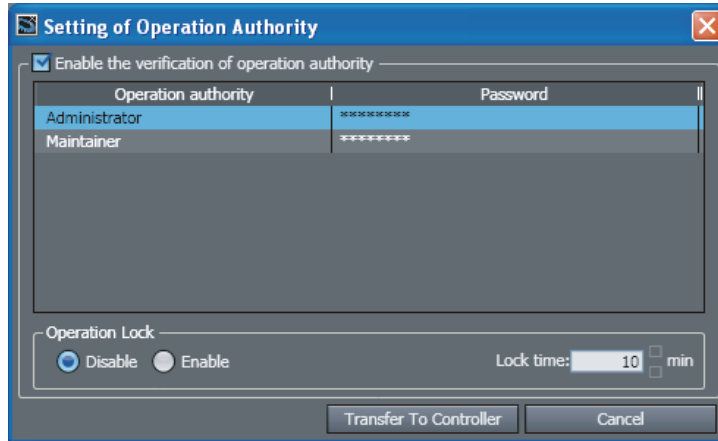

- 2 Select the **Enable** Option in the **Operation Lock** Area, enter the **Lock time**, and click the **Transfer To Controller** Button.

8-3-3 User Authentication

This function authenticates each user who attempts to go online by username and password to identify the user who performs online operations.

✓ Version Information

To use user authentication, one of the following CPU Units and Sysmac Studio versions are required.

Sysmac Studio version 1.50 or higher

Model	Project unit version	Supported OS
NX102-□□00, NX102-□□20	Version 1.49 or later	Windows 10 version 1803 or later For details, refer to the <i>NJ/NX-series CPU Unit Software User's Manual (Cat. No. W501)</i> .
NX1P2-□□□□DT, NX1P2-□□□□DT1	Version 1.49 or later	
NJ101-□□00, NJ101-□□20	Version 1.49 or later	
NJ301-1□00	Version 1.49 or later	
NJ501-1□00, NJ501-1□20, NJ501-1340, NJ501-5300, NJ501-4□□□, NJ501-R□□□	Version 1.49 or later	
NX701-□□□□	Version 1.29 or later	

Sysmac Studio version 1.54 or higher

Model	Project unit version	Supported OS
NX502-1□00	Version 1.60 or later	Windows 10 version 1803 or later For details, refer to the <i>NJ/NX-series CPU Unit Software User's Manual (Cat. No. W501)</i> .

User Authentication

● Overview

User authentication provides a function to register in advance users who are allowed to operate the Controller so that the user who operates the Controller online can be identified. When you try to go online to the Controller, you are asked to enter your username and password. If the username and password do not match the registered settings, you are not allowed to go online.

In addition, each user is assigned one of the following levels of operation authority: Administrator, Designer, Maintainer, Operator, and Observer. This ensures that they can only perform online operations with the Controller within the authority assigned to them.

User authentication settings, such as username, password, and other information on the operation authority of each user, are stored in the Controller. This means that you can use the user authentication function from another computer to connect to the Controller.

The user authentication settings are not stored in the project. Configure the user authentication settings for each Controller that uses the user authentication function.



Precautions for Correct Use

- The user authentication settings are available only when going online.
- Only the Administrator can change and transfer the user authentication settings to the Controller.
- You cannot go online if you forget the user authentication password. Manage the password in case you forget it. Refer to *What to Do if You Forget the Administrator Username or Password* on page 8-33 later in this manual for information on what to do if you forget the password.

● Types of Operation Authorities

There are five levels of operation authority for the Sysmac Studio, as given below (in order starting with the greatest level of authority).

- Administrator
- Designer
- Maintainer
- Operator
- Observer

● Applicable Online Operations

The functions, authorities, and operation restrictions that require authentication are given below.

Supported: Operation possible, VR: Verification required for each operation, NP: Operation not possible

Monitoring status	Administrator	Designer	Maintainer	Operator	Observer
Controller status	Supported	Supported	Supported	Supported	Supported
Statuses of Special I/O Units and slaves	Supported	Supported	Supported	Supported	Supported
Troubleshooting and event logs	Supported	Supported	Supported	Supported	Supported

Monitoring status	Admin- istrator	Design- er	Main- tainer	Opera- tor	Observ- er
Reading CPU Unit names	Support- ed	Support- ed	Support- ed	Support- ed	Support- ed
Operations to monitor I/O	Admin- istrator	Design- er	Main- tainer	Opera- tor	Observ- er
Reading I/O	Support- ed	Support- ed	Support- ed	Support- ed	NP
Writing I/O	Support- ed	Support- ed	Support- ed	VR	NP
Set/Reset	Support- ed	Support- ed	Support- ed	VR	NP
Forced refreshing (TRUE/FALSE/Clear)	Support- ed	Support- ed	Support- ed	NP	NP
Monitoring programs, functions, and function blocks Differential monitoring	Support- ed	Support- ed	Support- ed	Support- ed	NP
Controller operations	Admin- istrator	Design- er	Main- tainer	Opera- tor	Observ- er
RUN mode	Support- ed	Support- ed	VR	NP	NP
PROGRAM mode	Support- ed	Support- ed	VR	NP	NP
Online editing	Support- ed	Support- ed	VR	NP	NP
Data trace operations (starting, stopping, forcing triggers, and uploading set- tings)	Support- ed	Support- ed	Support- ed	Support- ed	NP
Releasing access rights	Support- ed	Support- ed	NP	NP	NP
Clearing all memory	Support- ed	NP	NP	NP	NP
Resetting the Controller	Support- ed	Support- ed	NP	NP	NP
Resetting errors (troubleshooting)	Support- ed	Support- ed	Support- ed	VR	NP
Clearing event logs (error logs)	Support- ed	Support- ed	Support- ed	NP	NP
Controller clock	Support- ed	Support- ed	NP	NP	NP
SD Memory Card operations	Support- ed	Support- ed	Support- ed	Support- ed	NP
Updating CPU Unit names	Support- ed	Support- ed	NP	NP	NP
Setting user program execution IDs	Support- ed	NP	NP	NP	NP
Setting write protection of the CPU Unit	Support- ed	Support- ed	Support- ed	NP	NP
MC Test Run	Support- ed	Support- ed	VR	NP	NP

Controller operations	Administrator	Designer	Maintainer	Operator	Observer
Restarting CJ-series EtherNet/IP Units	Supported	Supported	Supported	NP	NP

Transfer operations	Administrator	Designer	Maintainer	Operator	Observer
Synchronization Note: Uploading and downloading are supported (including transferring only part of a project)	Supported	Supported	Supported	NP	NP
Transferring parameter settings of a CJ-series Unit mounted on the CPU/Expansion Rack to the Controller	Supported	Supported	Supported	NP	NP
Transferring parameter settings of a CJ-series Unit mounted on the CPU/Expansion Rack from the Controller	Supported	Supported	Supported	NP	NP
Transferring operation settings of an NX Unit mounted on the CPU/Expansion Rack to the Controller	Supported	Supported	Supported	NP	NP
Transferring operation settings of an NX Unit mounted on the CPU/Expansion Rack from the Controller	Supported	Supported	Supported	NP	NP
Transferring data to the Controller from the EtherCAT Configuration Display Tab Page	Supported	Supported	Supported	NP	NP
Transferring data from the Controller to the EtherCAT Configuration Display Tab Page	Supported	Supported	Supported	NP	NP
Transferring data to the Controller from the Slave Terminal Unit Settings	Supported	Supported	Supported	NP	NP
Transferring data from the Controller to the Slave Terminal Unit Settings	Supported	Supported	Supported	NP	NP
Writing the setting of the Setting Change during RUN Mode parameter in the Controller Setup	Supported	Supported	Supported	NP	NP
Transferring operation authority verification settings	VR	NP	NP	NP	NP
Transferring user account settings	VR	NP	NP	NP	NP
Showing user account list	Supported	Supported	Supported	NP	NP
Secure Socket Settings	VR	NP	NP	NP	NP
Transferring the Secure Communications Setting	Supported	NP	NP	NP	NP

Backup and restore operations	Administrator	Designer	Maintainer	Operator	Observer
Backing up and restoring Controller data and comparing data with Controller data	Supported	Supported	VR	NP	NP
Backing up data to SD Memory Card and comparing data with data in SD Memory Card	Supported	Supported	Supported	NP	NP
Backing up variables and memory	Supported	Supported	Supported	NP	NP
Restoring variables and memory	Supported	Supported	NP	NP	NP

Slave Terminal operations	Administrator	Designer	Maintainer	Operator	Observer
Clearing all memory	Supported	Supported	Supported	NP	NP
Restarting	Supported	Supported	Supported	NP	NP
User calibration (Analog I/O Unit)	Supported	Supported	Supported	NP	NP

CPU Rack operations (X Bus)	Administrator	Designer	Maintainer	Operator	Observer
Clearing All Memory of X Bus Units	Supported	Supported	Supported	NP	NP
Transferring parameter settings to X Bus Unit	Supported	Supported	Supported	NP	NP
Transferring parameter settings from X Bus Unit	Supported	Supported	Supported	NP	NP

CPU Rack operations (NX Bus)	Administrator	Designer	Maintainer	Operator	Observer
Clearing All Memory of NX Units	Supported	Supported	Supported	NP	NP
Restarting NX Bus or NX Unit	Supported	Supported	Supported	NP	NP
User calibration (NX Analog I/O Unit)	Supported	Supported	Supported	NP	NP

● Password Requirements

Item	Description
Password length	Minimum 8 characters and maximum 32 characters
Usable characters	Single-byte alphanumeric characters (case sensitive)

Procedure for Setting User Accounts

Set up a new user account when you go online with the Controller for the first time.

The contents of the dialog box displayed when you set up a new user account differ depending on the combination of the CPU Unit that supports secure communications and the Sysmac Studio version. Refer to *8-3-1 Secure Communications Setting* on page 8-9 for details.

● Setting a New User Account (for Controllers that Support User Authentication, but Do Not Support Secure Communication Version 2)

Perform the following procedure with the Sysmac Studio connected online with a Controller for which user authentication and operation authority are not set.

- 1 The following dialog box is displayed when you attempt to go online.

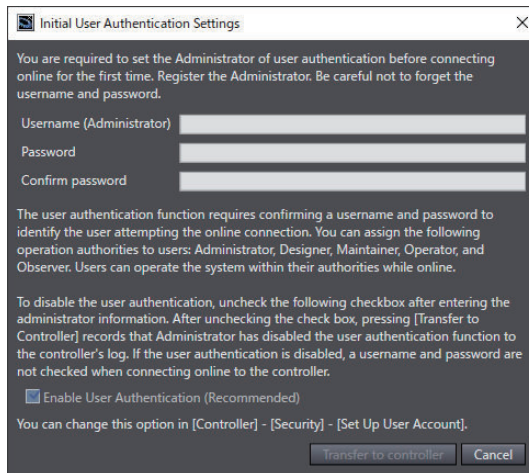

- 2 Enter the Administrator's username into the **Username (Administrator)** Text Box.
- 3 Enter the password in the **Password** Text Box. Enter the same password in the confirmation field.
- 4 Check the **Enable User Authentication (Recommended)** Check Box.
- 5 Click the **Transfer to controller** Button to write the settings into the Controller. A transfer confirmation dialog box is displayed.

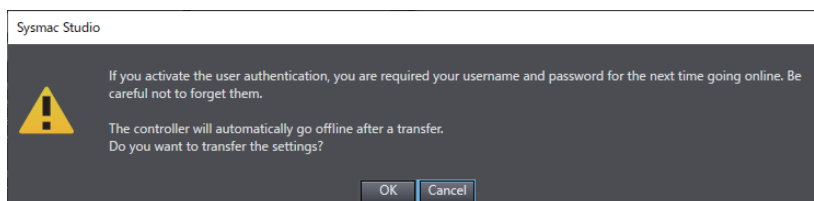

- 6 Click the **OK** Button. A dialog box for completion of setting user account is displayed.

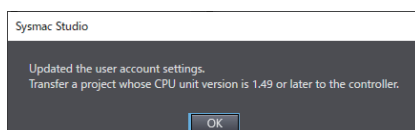

● Setting a New User Account (for Controllers that Support Secure Communication Version 2)

- 1 The following dialog box is displayed when you attempt to go online.

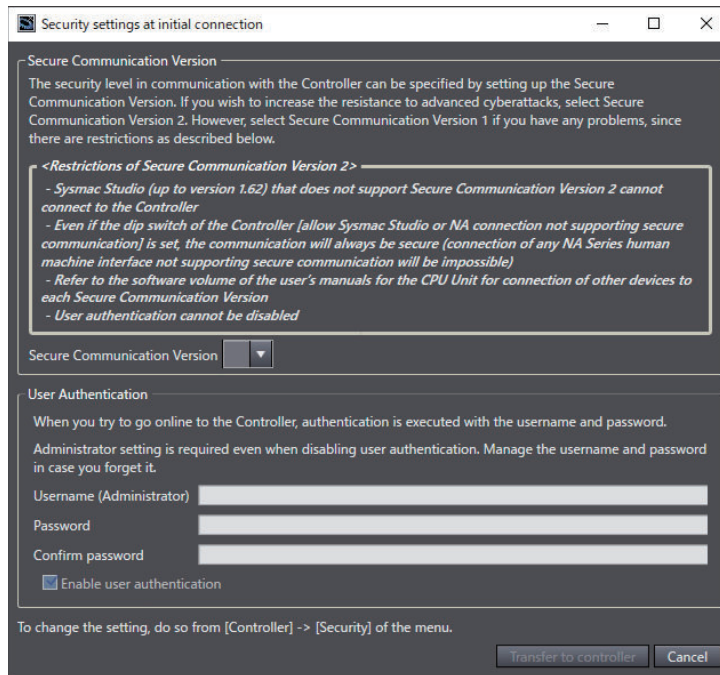

- 2 Select the **Secure Communication Version**.
Refer to 8-3-1 *Secure Communications Setting* on page 8-9 for details on the **Secure Communication Version**.
- 3 Enter the Administrator's username into the **Username (Administrator)** Text Box.
- 4 Enter the password in the **Password** Text Box. Enter the same password in the confirmation field.
- 5 Select the **Enable user authentication** Check Box.
If **Secure Communication Version** is set to 2 in step 2, the **Enable user authentication** check box is always selected.
- 6 Click the **Transfer To Controller** Button.
A transfer confirmation dialog box is displayed.

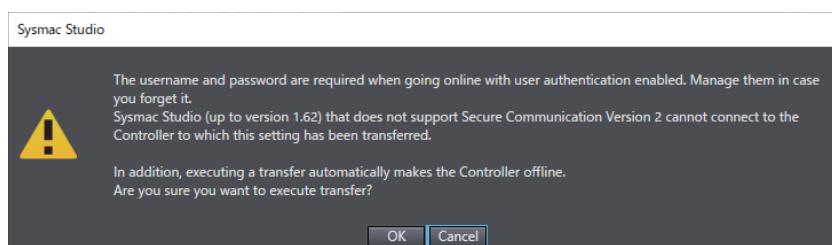

- 7 Click the **OK** Button.
A dialog box is displayed to confirm that user account settings have been completed. Click the **OK** Button.

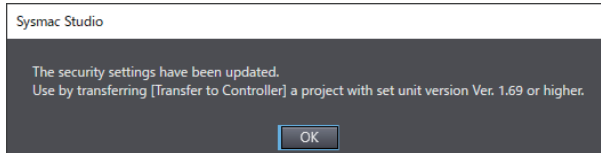

● Procedure for Adding User Accounts

Only users with the *Administrator* operation authority can add user accounts. Perform the following procedure with the Sysmac Studio connected online with a target Controller through the *Administrator* user account.

- 1 Select **Security – Set up user account** from the **Controller** Menu.
The **Authentication** Dialog Box is displayed. Enter the password of *Administrator* authenticated when you went online, and click the **OK** Button.



When the authentication is completed, the **User Account Settings** Dialog Box is displayed.

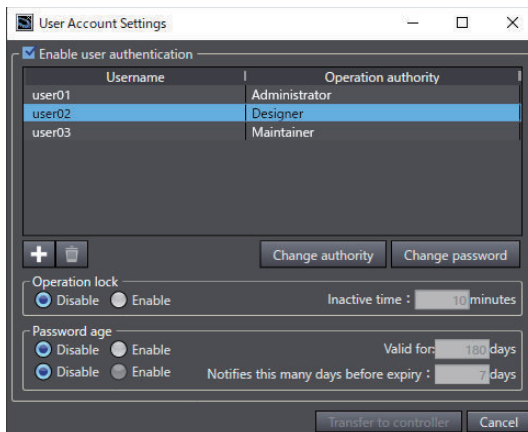

- 2 Select the **Enable user authentication** Check Box and click the **Add user** Button.
The **Add account** Dialog Box is displayed.
- 3 Enter the username into the **Username** textbox.

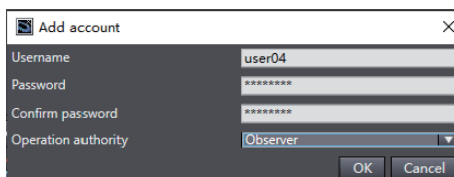

- 4 Enter the password in the **Password** textbox. Enter the same password in the confirmation field.

- 5 Click the combo box of Operation authority, select *Administrator*, *Designer*, *Maintainer*, *Operator*, or *Observer*, and then click the **OK** Button.
- 6 Click the **Transfer to controller** Button to write the settings into the Controller. A transfer confirmation dialog box is displayed.

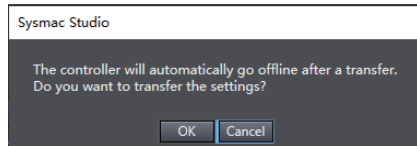

- 7 Click the **OK** Button. A dialog box for completion of setting user account is displayed.

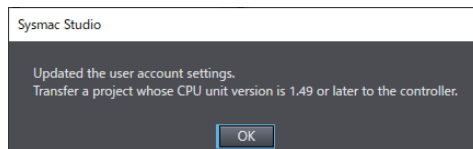

● Procedure for Changing Operation Authority

Only users with the *Administrator* operation authority can change operation authority. Perform the following procedure with the Sysmac Studio connected online with a target Controller through the *Administrator* user account.

- 1 Select **Security – Set up user account** from the **Controller** Menu. The **Authentication** Dialog Box is displayed. Enter the password of *Administrator* authenticated when you went online, and click the **OK** Button.

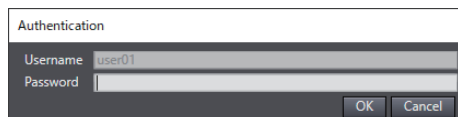

When the authentication is completed, the **User Account Settings** Dialog Box is displayed.

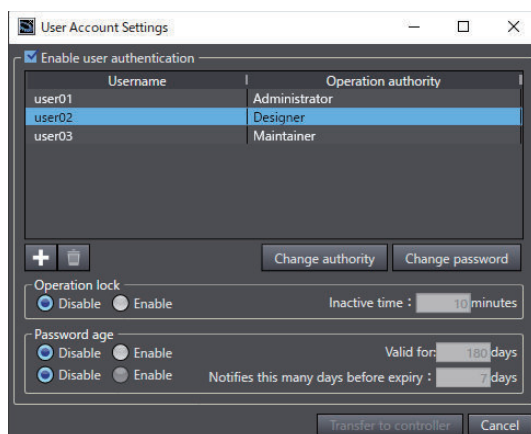

- 2 Select the **Enable user authentication** Check Box, select the user for whom to change operation authority, and click the **Change authority** Button.
The Change authority Dialog Box is displayed.

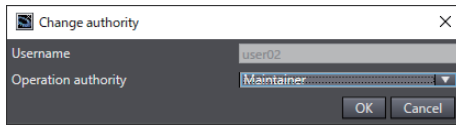

- 3 Click the combo box of Operation authority, select *Administrator*, *Designer*, *Maintainer*, *Operator*, or *Observer*, and then click the **OK** Button.

- 4 In the **User Account Settings** Dialog Box, use the same procedure as adding user accounts to write the settings to the Controller.



Precautions for Correct Use

You must set at least one user account with the *Administrator* operating authority on the Controller. If no *Administrator* user account is set, you cannot perform the transfer of user account settings.

● Procedure for Changing User Password (Administrator)

Only users with the *Administrator* operation authority can change passwords. Perform the following procedure with the Sysmac Studio connected online with a target Controller through the *Administrator* user account.

- 1 Select **Security – Set up user account** from the **Controller** Menu.
The **Authentication** Dialog Box is displayed. Enter the password of *Administrator* authenticated when you went online, and click the **OK** Button.



When the authentication is completed, the **User Account Settings** Dialog Box is displayed.

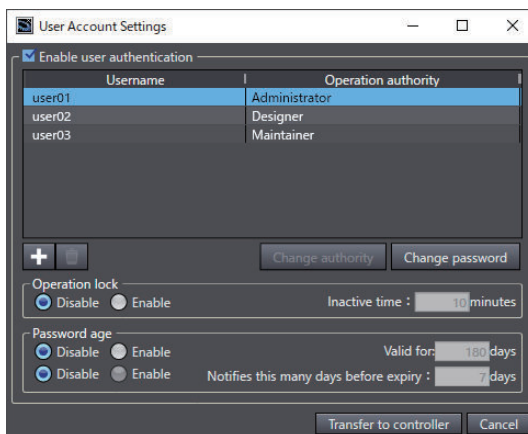

- 2 Select the **Enable user authentication** Check Box, select the user for whom to change operation authority, and click the **Change password** Button.
The Change password Dialog Box is displayed.

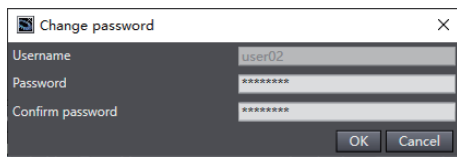

- 3 Enter a new password in the **Password** textbox. Enter the same password in the confirmation field, and click the **OK** Button.
- 4 In the **User Account Settings** Dialog Box, use the same procedure as adding user accounts to write the settings to the Controller.

● Procedure for Changing Your Password

You can change your own password regardless of the operation authority. Perform the following procedure with the Sysmac Studio connected online to a target Controller through your own user account.

- 1 Select **Security – Change user account password** from the **Controller** Menu.
The **Authentication** Dialog Box is displayed. Enter the current password and click the **OK** Button.

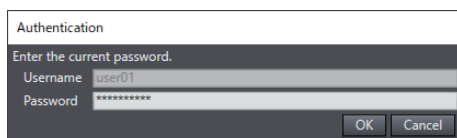

- 2 The **Password Change** Dialog Box is displayed.

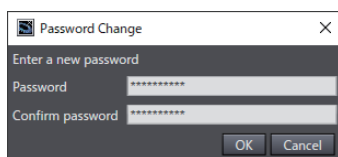

- 3 Enter a new password in the **Password** Text Box. Enter the same password in the confirmation field, and click the **OK** Button.
- 4 A password change confirmation message is displayed. Click the **OK** Button.

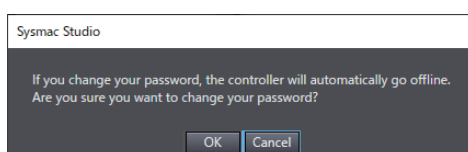

A password change completion message is displayed.

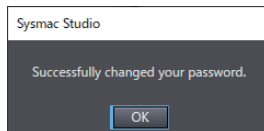

● Showing User Account List

Only users with the *Administrator*, *Designer*, or *Maintainer* operation authority can show a list of usernames that are registered in the user account setting. Perform the following procedure with the Sysmac Studio connected online with a target Controller through the *Administrator*, *Designer*, or *Maintainer* user account.

- 1 Select **Security – Show user account list** from the **Controller** Menu. The **Account list** Dialog Box is displayed.

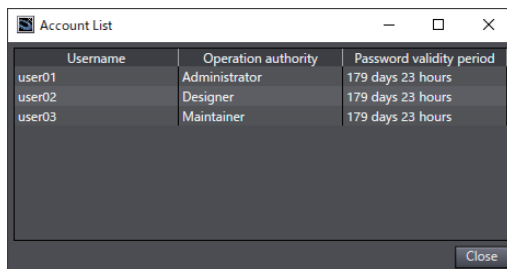

A list of user accounts that are currently set is shown.

Password Age

Use this function to set the password age for each user account. This reduces the risk of unauthorized access to the Controller. You can also enable the before-expiry notification setting to display the following message when online, which prevents forgetting to change your password.

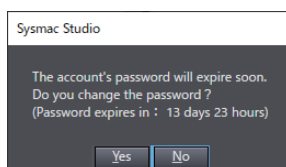

● Procedure for Setting the Password Age

Only users with the *Administrator* operation authority can set the password age. Perform the following procedure with the Sysmac Studio connected online to a target Controller through the *Administrator* user account.

- 1 Select **Security – Set up user account** from the **Controller** Menu. The **User Account Settings** Dialog Box is displayed.
- 2 Select the user for whom you want to set the password age and, in **Password age**, select the **Enable** Check Box for **Valid for**.

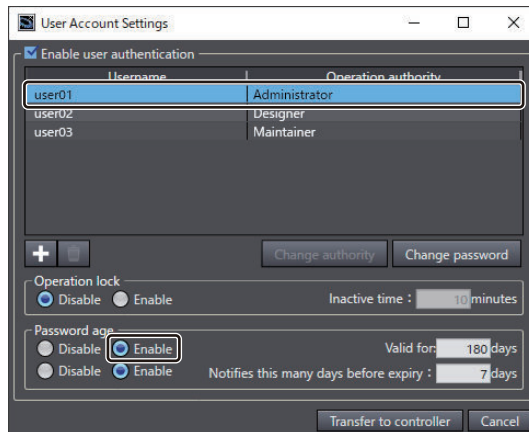

- 3** A message is displayed to ensure that the password age settings work correctly. Click the **OK** Button.

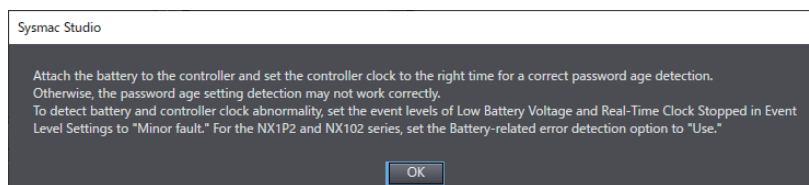

- 4** Enter the validity period (days) in the **Valid for** Text Box.

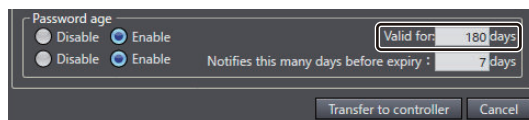

- 5** In **Password age**, select the **Enable** Check Box for **Notifies this many days before expiry** and enter the number of days.

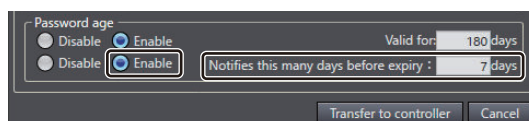

- 6** Click the **Transfer to controller** Button to write the settings into the Controller.

Authentication When Going Online

When user authentication is set on the Controller, user authentication is performed when going online. If verified, you can perform online operations according to your authority.

● Procedure for the Authentication Dialog Box

The **Authentication** Dialog Box is displayed when you attempt to go online.

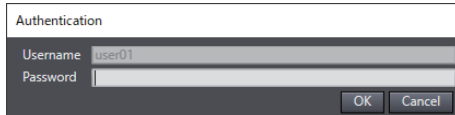

- 1 Enter the username and password, and click the **OK** Button.
If the password is correct, online operations are enabled.
The following warning is displayed if the username or password does not match. Click the **OK** Button, and then enter it again.

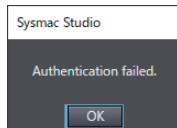

Authentication for Individual Operations

Authentication is performed each time a user with a certain authority or lower performs an operation that may damage equipment or cause injury due to incorrect operation.

Check the items with “VR” in *Applicable Online Operations* on page 8-20 for information on the applicable operations.

If you enter a wrong username or password 5 times in the Authentication Dialog Box, the **Operation Lock due to Authentication Failure** Dialog Box is displayed and the Sysmac Studio is locked for 10 minutes.

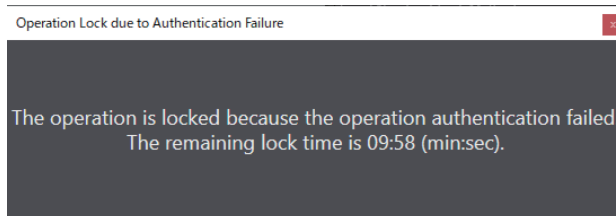

If you select an operation that cannot be used with the current authority, the following error message is displayed and the operation is not performed.

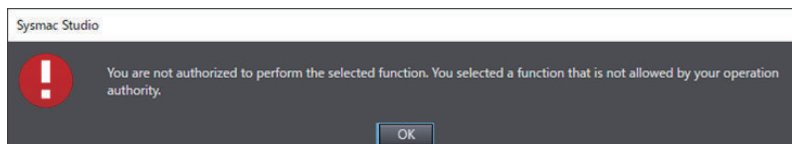

Go online again and retry authentication as a user with valid operation authority.

Operation Lock

You can set the operation lock on the Sysmac Studio to prevent it from being operated if there are no user operations for the time specified in the **User Account Settings** Dialog Box.

This prevents another user from mistakenly performing operations. If operation is locked, you need to perform authentication again.

User authentication must be set to use the operation lock. It cannot be used alone.

● Procedure to Set the Operation Lock

Perform the following procedure with the Sysmac Studio connected online with a target Controller.

- 1 Select **Security – Set up user account** from the **Controller Menu**.
The **User Account Settings** Dialog Box is displayed.
- 2 Select the **Enable** Option in the **Operation lock** Area, enter the **Inactive time**, and click the **Transfer to controller** Button.



What to Do if You Forget the Administrator Username or Password

If you have the *Administrator* operation authority and forget the username or password, you must initialize the Controller data to the factory default condition. To restore the factory default condition, set the Controller's DIP switch to *Safe Mode* and turn ON the power supply.

Refer to the *NJ-series CPU Unit Hardware User's Manual (Cat. No. W500)*, *NX-series CPU Unit Hardware User's Manual (Cat. No. W535)*, *NX-series NX502 CPU Unit Hardware User's Manual (Cat. No. W629)*, *NX-series NX102 CPU Unit Hardware User's Manual (Cat. No. W593)*, or *NX-series NX1P2 CPU Unit Hardware User's Manual (Cat. No. W578)* for details on how to set the DIP switch.

- 1 Set the target Controller's DIP switch to *Safe Mode*, turn ON the power supply, and go online. The **Authentication in Safe Mode** Dialog Box is displayed.

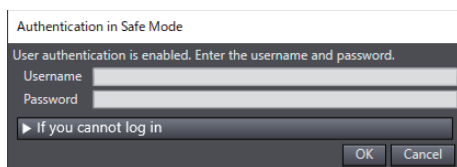

Read the instruction under **If you cannot log in** and check the **Agree** Check Box.

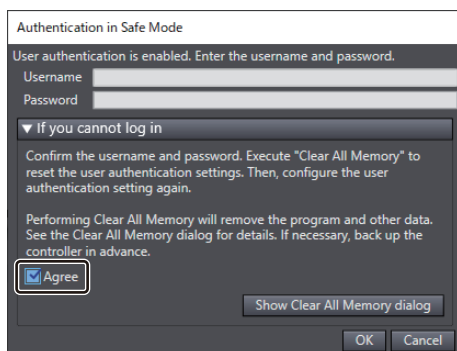

- 2 Click the **Show Clear All Memory dialog** Button to display the **Clear All Memory** Dialog Box.

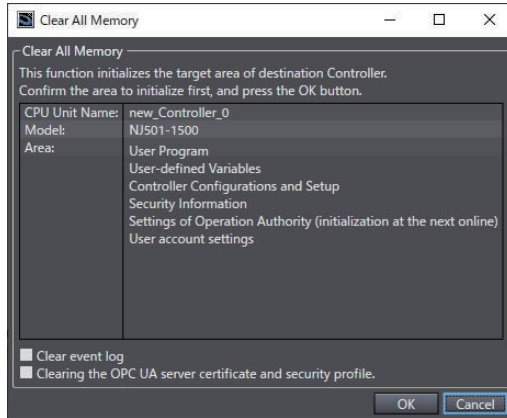

Additional Information

Refer to *8-6-1 Clearing All Memory of the CPU Unit* on page 8-58 for details on Clear All Memory operation.

- 3 Click the **OK** Button in the Clear All Memory Dialog Box.
After the memory is cleared, the following dialog box is displayed.

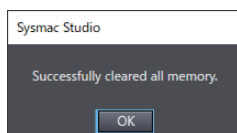

Turn OFF the power supply to the Controller and restore the DIP switch keys to the original positions. To go online again, set up a new user account by referring to *Procedure for Setting User Accounts* on page 8-23.

8-3-4 Authentication of User Program Execution IDs

If you enter a specific ID for the Controller in advance (called a *user program execution ID*), only a user program that is assigned that ID can be executed on the Controller.

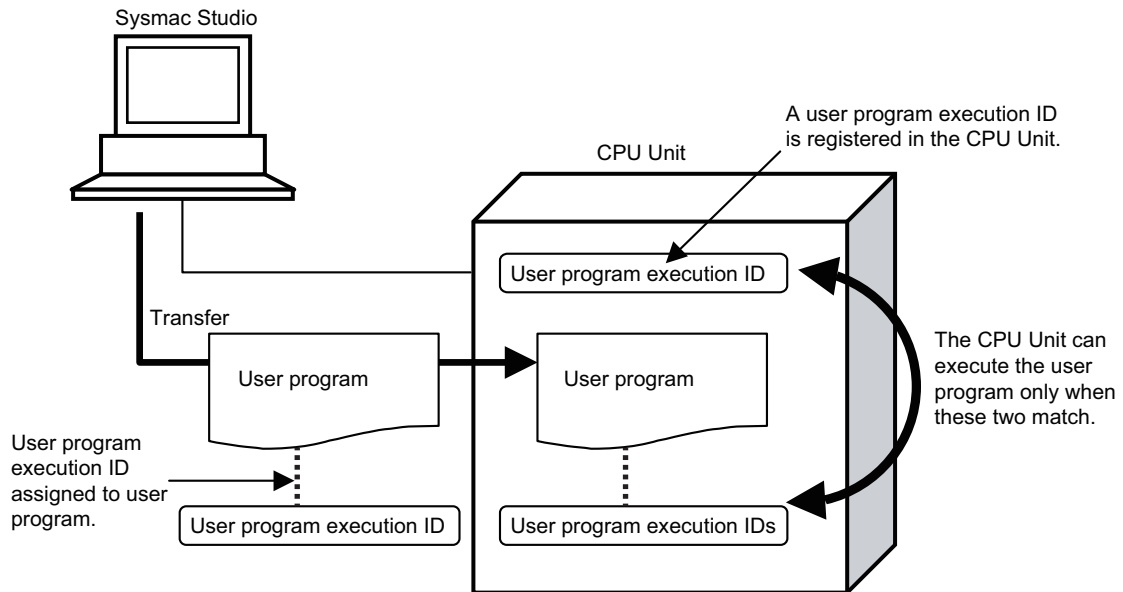

This function can be used to achieve the following:

- A Controller can be restricted to execute only a specific user program.
- You can prevent a user program from use on a different Controller (hardware).

This function is different from the protection functions in that the user program can be viewed and edited.

● Setting Ranges for User Program Execution IDs

Item	Description
Valid number of characters	8 to 32 characters
Applicable characters	Single-byte alphanumeric characters (case sensitive)

Refer to the *NJ/NX-series CPU Unit Software User's Manual (Cat. No. W501)* for details on the user program execution ID.

Setting User Program Execution IDs for User Programs

User program execution IDs for user programs are set offline.



Precautions for Correct Use

- A user program execution ID can be set only one time for a user program.
- Record the user program execution ID to ensure you do not lose it.
- We recommend that you backup the project file before you set the user program execution ID.

- 1 Select **Security - ID for User Program Execution** from the **Controller Menu**.
The **User Program Execution ID for Program** Dialog Box is displayed.

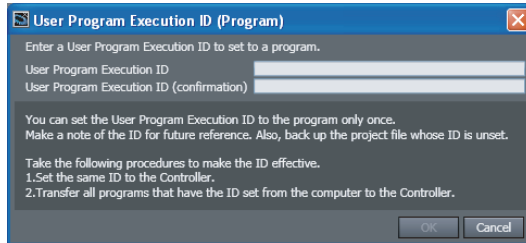

- 2 Enter the **User Program Execution ID**.
- 3 Enter the same ID in the **User Program Execution ID (Confirmation)** field, and then click the **OK** Button.

● Enabling User Program Execution IDs Verification

Use the following settings to enable user program execution ID verification.

- 1 Set the same ID as the Controller.
Refer to *Setting User Program Execution IDs for Controllers* on page 8-36, below.
- 2 Synchronize (download) the user program for which the user program execution ID is set.

Setting User Program Execution IDs for Controllers

User program execution IDs for Controllers are set online.



Precautions for Correct Use

- If operation authority verification is set, you must go online as the **Administrator**.

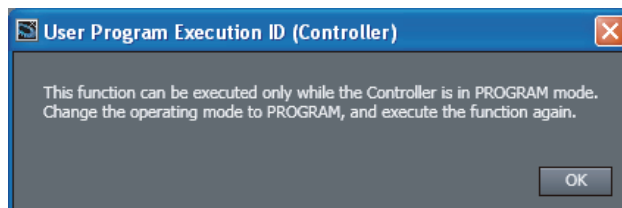

- Be sure to record the user program execution ID to ensure you do not lose it. You cannot change the user program execution ID even if you lose it.
- The user program execution ID that is set for the Controller is deleted by the Clear All Memory Operation.

- 1 Select **Security - ID for User Program Execution** from the **Controller** Menu.
The **Set User Program Execution ID for Controller** Dialog Box is displayed.

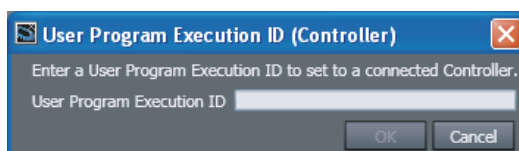

- 2 Enter the same ID as the user program execution ID that is set for the user program, and click the **OK** Button.
- 3 Cycle the power supply to the Controller to enable the setting in the Controller.

8-3-5 Write Protection of the CPU Unit

You can prevent the Sysmac Studio from overwriting data in the CPU Unit.

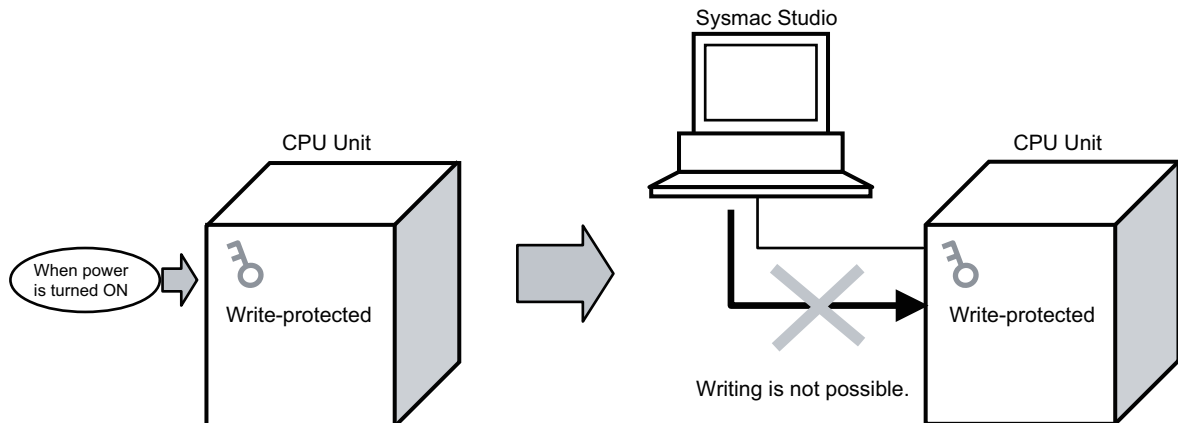

Settings for Write Protection at Startup

You can automatically enable write protection for the CPU Unit when the Controller is turned ON to prevent write operations from the Sysmac Studio.

- 1 Select **Operation Settings** under **Configurations and Setup - Controller Setup**. The **Basic Settings** Pane for the Controller's Operation Settings is displayed.

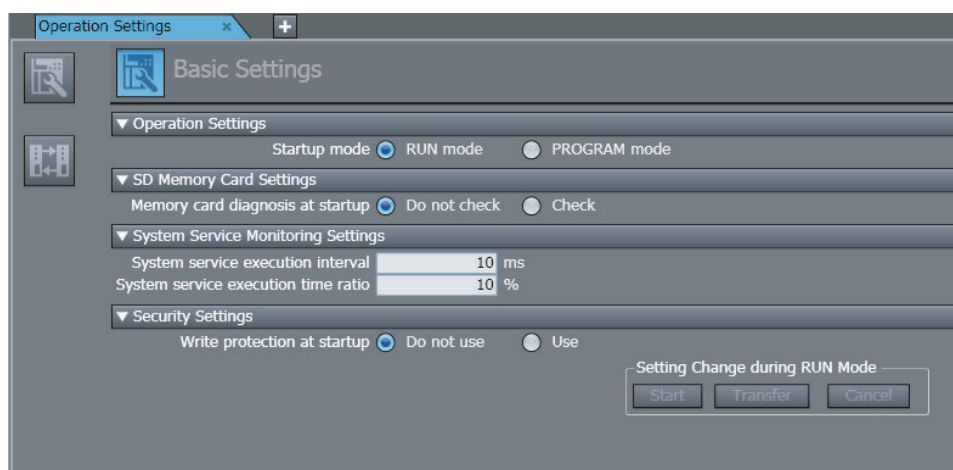

- 2 Select the **Use** Option for **Write protection at startup** in the **Security Settings** Area.
- 3 Execute **Transfer to Controller** to enable the setting.

Clearing Write Protection

You can temporarily clear the write protection on a CPU Unit that is write-protected.

- 1 Select **Security – CPU Unit Write Protection** from the **Controller** Menu while online.

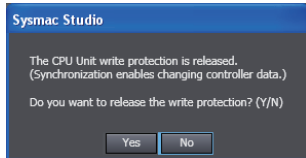

- 2 Click the **Yes** Button.

This removes write protection. The following dialog box is displayed.

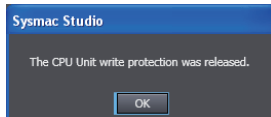

Setting Write Protection

You can temporarily set write protection on a CPU Unit that is not write-protected from the Sysmac Studio.

- 1 Select **Security – CPU Unit Write Protection** from the **Controller** Menu while online.

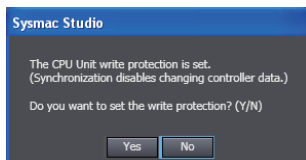

- 2 Click the **Yes** Button.

This sets write protection. The following dialog box is displayed.

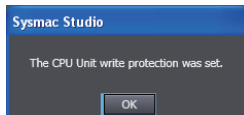



Additional Information

Setting write protection will display the following message when you attempt to write data to the CPU Unit.

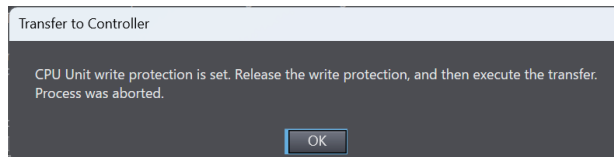

8-3-6 Data Protection

● Data Protection

The data protection function allows you to set passwords for individual data units to restrict displaying, changing, and copying them (access restrictions). You can enter the password to temporarily clear the protection from a data unit. Data protection is set and canceled offline.



Precautions for Correct Use

The data protect function protects a program from unintentional display or modification of information due to mistakes made by a trusted user. Use *Password protection for project files* to protect the entire project from malicious access or *Library Without Source Code* to protect parts of the program. Refer to 3-3-9 *Password Protection for Project Files* on page 3-22 and 9-3-1 *Creating a Library* on page 9-8 for details.

● Access Restrictions

The following table describes the access restrictions.

Access restriction	Operation	Remarks
Display prohibition	The restricted data cannot be displayed.	This restriction applies to jumping from other windows, displaying detailed comparison results, viewing search results, and printing previews.
Change prohibition	The restricted data cannot be changed. The data can be displayed but not changed on the display.	This restriction also applies to online editing and replacement operations.
Copy prohibition	The restricted data cannot be copied.	

● Data That Can Be Protected

The following table lists the data that you can protect from being displayed, changed, and copied. Protection is implemented by setting a password for each data unit.

Data		Remarks
Cam settings	Cam profiles	Only <i>change prohibition</i> can be set.

Data		Remarks
Programs	Ladder diagrams	The restrictions apply to the local variable tables.
	ST	
Functions	Ladder diagrams	
	ST	
Function blocks	Ladder diagrams	
	ST	
Libraries with source code	Ladder functions	The protection settings for objects in accessed libraries cannot be changed.
	ST functions	
	Ladder function blocks	
	ST function blocks	

● Procedure to Set Protection

- 1 Select the data to protect, and then select **Security – Set/Release Data Protection** from the **Controller** Menu. Or right-click the data to protect, and select **Security – Set/Release Data Protection** from the menu.

The Data Protection Setting Dialog Box is displayed.

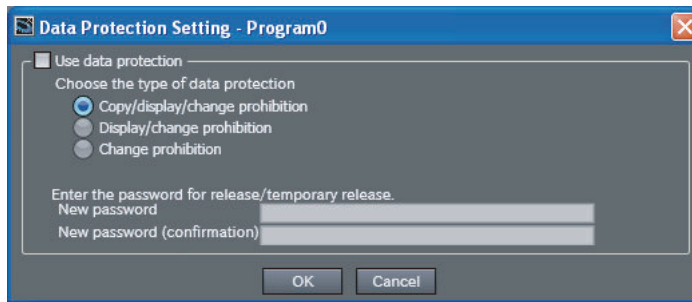

- 2 Select the **Use data protection** Check Box and select the access restrictions. Enter the password, and then click the **OK** Button.

Data protection is set and the icon on the protected data changes in the Multiview Explorer.

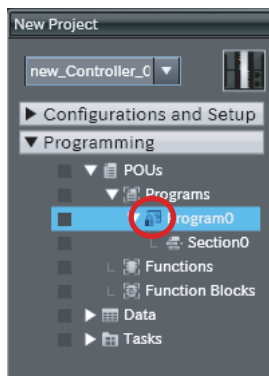



Precautions for Correct Use

You will not be able to temporarily clear protection or remove the protection setting if you forget the password. Protection settings are also transferred for synchronization operations. If you forget the passwords for protected data that was transferred to the Controller, you will no longer be able to display or change the protected data. Record the password in case you forget it.

● Temporarily Clearing Protection

To perform operations on protected data, you can enter the password to temporarily clear the protection.

- 1 Perform the restricted operation for the protected data. If changing the data is restricted, right-click the data and select **Security – Temporary Release of Change Prohibition** from the menu.

The Temporary Release of Data Protection Dialog Box is displayed.

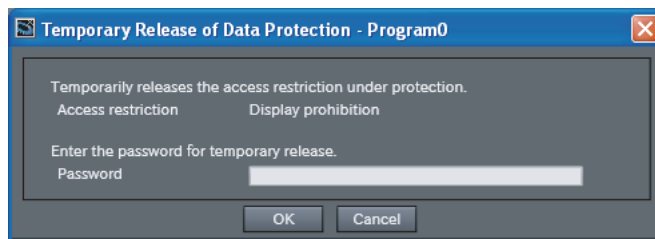

- 2 Enter the password that was set when data protection was set.

The access restrictions are temporarily cleared.

The following table gives the lengths of time for which the access restrictions are temporarily cleared.

Access restriction	Length of time that protection is cleared
Display prohibition	While the project is open
Change prohibition	While the project is open or until Finish Temporary Release of Change Prohibition is selected from the menu
Copy prohibition	The password must be entered for each copy operation.

The Sysmac Studio is locked for 10 minutes if you consecutively enter the wrong password 5 times for the same Controller. The Temporary Release of Data Protection Dialog Box is displayed again in 10 minutes.

The icons for protected data change as shown in the following table.

Data	Protected
Ladder diagrams	
ST	
Ladder debugging programs	
ST debugging programs	

Data	Protected
Cam profiles	



Precautions for Correct Use

Even if the access restrictions to prohibit displaying data are set, the dialog box to temporarily clear data protection is not displayed for detailed comparison results, printing, or printing previews.

For detailed comparison results, clear the protection before you execute the comparison operation.

For printing and printing previews, display the data from the Multiview Explorer and temporarily clear protection before you use printing or print previews.

● Temporarily Releasing All Protection for a Specific Password

If the same password is used to protect different data, you can temporarily release protection for all of that data.

The data for which protection is released is all data for which access restrictions prohibit displaying or changing the data, except for the library data under the Controller.

- 1 Select **Security – Temporary Release of Display/Change Prohibition** from the **Controller** Menu.

The Temporary Release of Data Protection Dialog Box is displayed.

- 2 Enter the password for which to release protection.

The access restrictions for the password that you enter are released temporarily.

To release protection for another password, repeat the procedure from step 1.

The protection is released until the effective period for temporarily releasing protection is reached or until you select **Security – Finish Temporary Release of Display/Change Prohibition** from the **Controller** Menu.

All protection that was temporarily released is restored when you select **Finish Temporary Release of Display/Change Prohibition**.

● Procedure to Cancel Protection

- 1 Select the data for which to cancel protection, and then select **Security – Set/Release Data Protection** from the **Controller** Menu. Or right-click the data for which to cancel protection, and select **Security – Set/Release Data Protection** from the menu.

The Temporary Release of Data Protection Dialog Box is displayed.

- 2 Enter the password, and click the **OK** Button.

The Data Protection Setting Dialog Box is displayed.

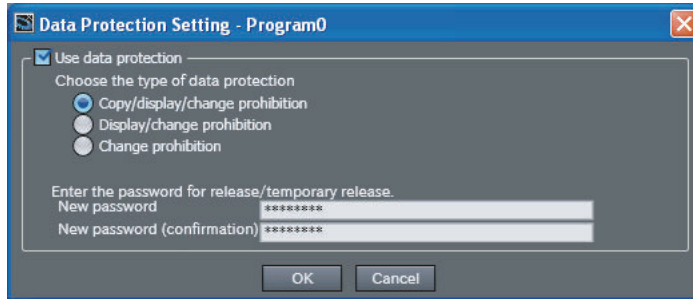

- 3 Clear the *Use data protection* Check Box and click the **OK** Button.
Data protection is cleared and the protection icon returns to the normal icon.

● Protection Version

The protection level of POU data and cam profiles can be raised by setting a higher protection version. You can set a protection version for each Controller.

It is recommended to set the highest possible protection version.

✓ Version Information

The settable protection version depends on the Sysmac Studio version, project unit version, project type, and Controller.

- Settable protection version for POU data

Sysmac Studio version	Project unit version	Settable protection version ^{*1}	Project type	Controller
Version 1.52 or higher	Ver. 1.12 or earlier	Ver. 1.0	<ul style="list-style-type: none"> • Standard Project • Library Project • Version-controlled Project 	All NJ/NX/NY-series Controllers
Version 1.56 or lower	Ver. 1.13 or later	Ver. 1.0 or 2.0		
Ver. 1.57 or higher	Ver. 1.13 or later	Ver. 1.0, 2.0, or 2.1		

*1. When a new project is created, it is set to version 1.0.

- Settable protection version for cam profiles

Sysmac Studio version	Project unit version	Settable protection version ^{*1}	Project type	Controller
Version 1.55 or higher	All project unit versions	Version 1.0 or 2.0	<ul style="list-style-type: none"> • Standard Project • Library Project • Version-controlled Project 	All NJ/NX/NY-series Controllers

*1. When a new project is created, it is set to version 1.0.

● Procedure for Changing the Protection Version

The following procedure is an example of changing the protection version of POU data.

- 1 Right-click the device icon in the Multiview Explorer and select **Property** from the menu.

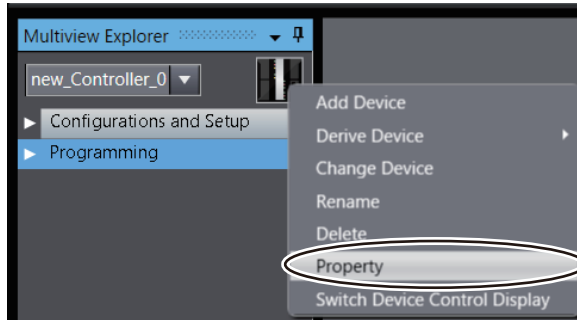

The **Property** Dialog Box is displayed.

- 2 In the **Property** Dialog Box, select a version in **POU Data Protection Version** and click the **OK** Button.

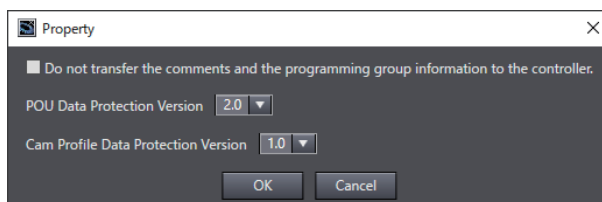

- 3 A version change confirmation message is displayed. Click the **Yes** Button.

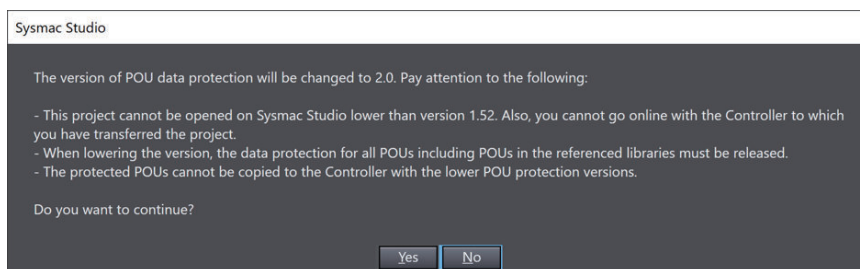

Precautions for Correct Use

- To set a lower protection version, you must release the protection setting. Refer to *Procedure to Cancel Protection* on page 8-42 for the procedure to release the protection setting. Also, if objects in a library referenced by the project are protected, the library reference must be deleted.
- After you change the protection version, transfer all data to the Controller again.
- Depending on the combination of the data protection version and the Sysmac Studio version, an error message about version compatibility may appear, preventing you from opening the project.
 - a) Opening a project whose POU data protection version is 2.0 in the Sysmac Studio lower than version 1.52.
 - b) Opening a project whose POU data protection version is 2.1 in the Sysmac Studio lower than version 1.57.
 - c) Opening a project whose cam profile data protection version is 2.0 in the Sysmac Studio lower than version 1.55.
- Set a lower protection version only for compatibility with previous versions of the Sysmac Studio.

8-3-7 Secure Socket Settings

The secure socket settings enable the secure socket services of the CPU Unit. Refer to the *NJ/NX-series CPU Unit Built-in EtherNet/IP Port User's Manual (Cat. No. W506)* for the secure socket services.



Precautions for Correct Use

The secure socket settings will be erased by performing Clear All Memory operation to completely erase data. If you clear the *Erase the data completely* Check Box in Clear All Memory Options, however, the settings will not be erased.



Version Information

An NX502 CPU Unit with unit version 1.60 or later and Sysmac Studio version 1.54 or higher, or an NX102 or NX1P2 CPU Unit with unit version 1.60 or later and Sysmac Studio version 1.53 or higher, are required to use the secure socket settings.

For NX102 or NX1P2 CPU Units with unit version 1.50 or earlier, Sysmac Studio version 1.54 or higher is required.

● Procedure for Displaying the Session List

Only users with the *Administrator* operation authority can use this function. Perform the following procedure with the Sysmac Studio connected online with a target Controller through the *Administrator* authority.

- 1 Select **Controller – Security – Secure Socket Settings** from the Main Menu.
If user authentication is set, the following **Authentication** Dialog Box is displayed.

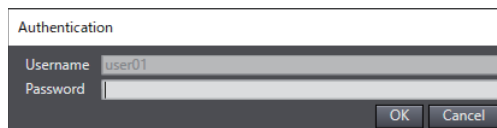

If operation authority verification is set, the following **Verification** Dialog Box is displayed.

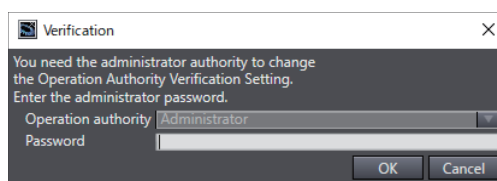

- 2 Enter the password of *Administrator* authenticated when you went online, and click the **OK** Button.
When the authentication or verification is completed, the **Secure Socket Settings** Dialog Box is displayed.

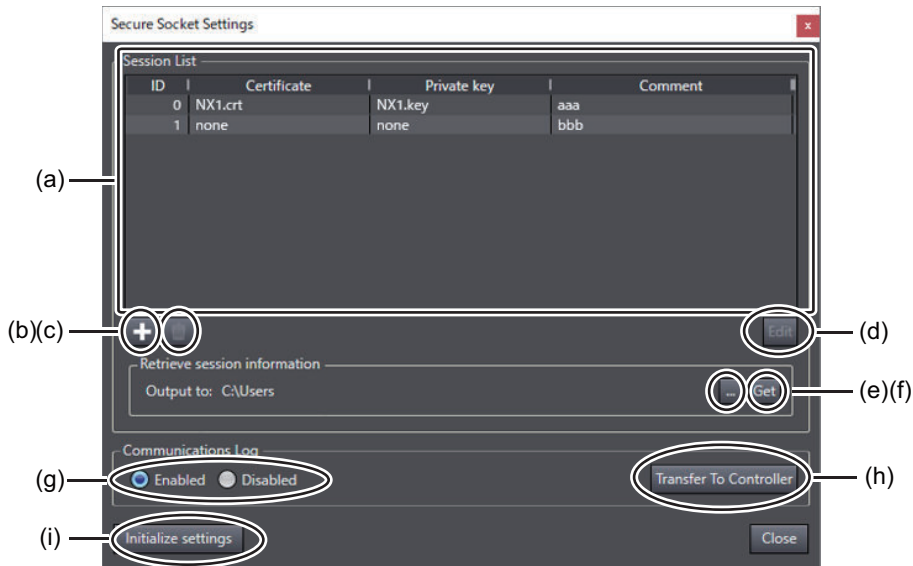

No.	Item	Description
(a)	Session List	Lists all sessions registered in the Controller.
(b)	Add button*1	Displays the Session Edit Dialog Box for a new session.
(c)	Delete button*1	Deletes the selected session.
(d)	Edit Button*1	Displays the Session Edit Dialog Box for the selected session.
(e)	Folder selection button	Displays a dialog box for selecting the file output destination.
(f)	Get Button	Gets the session information and client certificate from the Controller and outputs to files.
(g)	Enabled/Disabled Option Button	Enables or disables the Controller's communications log output.
(h)	Transfer To Controller Button*1	Transfers the Controller's communications log output settings to the Controller.
(i)	Initialize settings Button*1	Initializes the secure socket settings for the Controller.

*1. This is enabled only in PROGRAM mode.

● Procedure for Adding or Changing a Session

- 1 To add a new session, click the + icon in the **Secure Socket Settings** Dialog Box. To change an existing session, select the session to edit from the **Session List** in the **Secure Socket Settings** Dialog Box and click the **Edit** Button. The **Session Edit** Dialog Box is displayed.

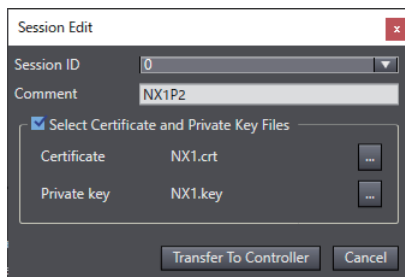

- 2 Enter a comment as needed.

- 3 Select the **Select Certificate and Private Key Files** Check Box.
- 4 Click the file selection dialog box button for **Certificate** and select the client certificate file.
- 5 Click the file selection dialog box button for **Private key** and select the client private key file.
- 6 Click the **Transfer To Controller** Button.
A session information transfer confirmation dialog box is displayed.

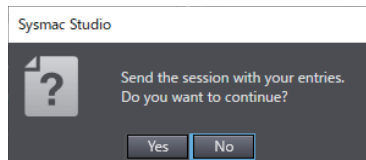

- 7 Click the **Yes** Button.
The session information is transferred.

● Outputting the Session Information File

- 1 Click the folder selection button and select the folder in which to output the session information file.
The selected folder is displayed next to **Output to:**.
- 2 Click the **Get** Button.
The session information file is output to the selected folder.

● Sending the Communications Log Settings

- 1 In the **Secure Socket Settings** Dialog Box, select **Enabled** in **Communications Log** and click the **Transfer To Controller** Button.
A communications log settings transfer confirmation dialog box is displayed.

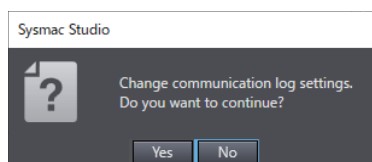

- 2 Click the **Yes** Button.
When transfer of the communications log settings is completed, the following dialog box is displayed.

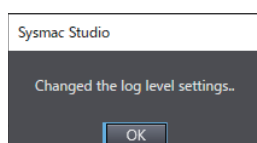

3 Click the **OK** Button.

8-4 User Memory Usage Monitor

● User Memory Usage Monitor

An estimate of the space that is used by the user program that you are editing in the Sysmac Studio is displayed in relation to the size of the Controller's memory. If the size of the user program exceeds the size of memory and it is transferred to the Controller, an error will occur in the Controller when you operate the Controller.



Precautions for Correct Use

The values that are displayed for memory usage are estimates. Use them as guidelines for current memory usage.

Refer to the *NJ/NX-series CPU Unit Software User's Manual (Cat. No. W501)* or *NY-series Industrial Panel PC / Industrial Box PC Software User's Manual (Cat. No. W558)* for the restrictions on the size of the user program.

Displaying Memory Usage

1 Select **Memory Usage** from the **Project** Menu.

With the side tab **Total**, an overview of the memory usage is displayed.

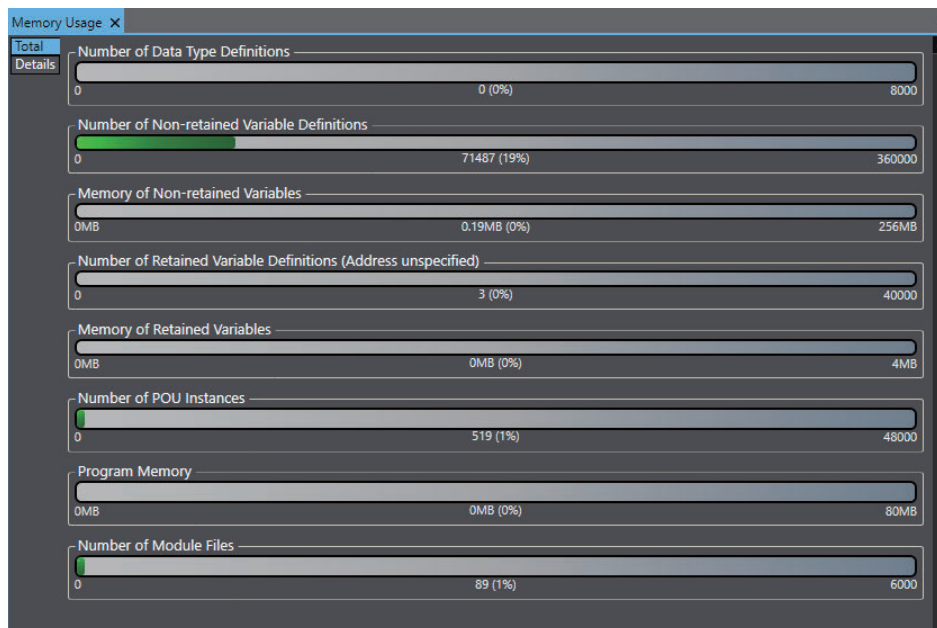

The **Total** view displays the following information.

Item	Displayed information
Number of Data Type Definitions	Displays the number of data types that are used.
Number of Non-retained Variable Definitions	Displays the number of non-retained variables that are used.
Memory of Non-retained Variable	Displays the usage of non-retained variable memory.

Item	Displayed information
Number of Retained Variable Definitions (Address Unspecified)	Displays the number of retained variables with unspecified addresses that are used.
Memory of Retained Variable	Displays the usage of retained variable memory.
Number of POU Instances	Displays the number of POU instances that are used.
Program Memory	Displays the usage of memory by the program.
Number of Module Files	Displays the number of module files to execute. The files are created for POUs and sections, and the display changes according to the number of POUs and sections.

2 Select the side tab **Details**.

The details of memory usage for tasks and global variables are displayed. The memory usage for each task is displayed for each program POU.

Task Details						
▼ Total by Task Type						
Type	Number of Non-retained Variable Definitions	Memory of Non-retained Variables	Number of Retained Variable Definitions (Address unspecified)	Memory of Retained Variables	Memory of Variables with External Variables	
Primary Periodic Tasks	9637	0.073 MB	0	0.000 MB	0.384 MB	
Periodic Tasks	29324	0.006 MB	0	0.000 MB	0.097 MB	
Event Tasks	23	0.000 MB	0	0.000 MB	0.008 MB	
▶ Primary Periodic Task Details						
▶ Periodic Task Details						
▼ Event Task Details						
Task Name	Program Name	Number of Non-retained Variable Definitions	Memory of Non-retained Variables	Number of Retained Variable Definitions (Address unspecified)	Memory of Retained Variables	Memory of Variables with External Variables
EventTask0	event000	23	0.000 MB	0	0.000 MB	0.008 MB
Global Variables						
▼ Total of Global Variables						
Type	Number of Non-retained Variable Definitions	Memory of Non-retained Variables	Number of Retained Variable Definitions (Address unspecified)	Memory of Retained Variables		
Global Variables	32500	0.109 MB	3	0.000 MB		

In the **Details** view, **Task Details** displays the following information for each task and each program POU.

Item	Displayed information
Number of Non-retained Variable Definitions	Displays the number of non-retained variables that are used.
Memory of Non-retained Variables	Displays the usage of the Controller's memory by non-retained variables.
Number of Retained Variable Definitions (Address unspecified)	Displays the number of retained variables used without specifying the address.
Memory of Retained Variables	Displays the usage of the Controller's memory by retained variables.
Memory of Variables with External Variables	Displays the usage of memory by variables defined in the program POU, including external variables.

In the **Details** view, **Global Variables** displays the following information.

Item	Displayed information
Number of Non-retained Variable Definitions	Displays the number of non-retained variables that are used.
Memory of Non-retained Variables	Displays the usage of the Controller's memory by non-retained variables.
Number of Retained Variable Definitions (Address unspecified)	Displays the number of retained variables used without specifying the address.
Memory of Retained Variables	Displays the usage of the Controller's memory by retained variables.



Additional Information

The side tab **Details** is not displayed for an NX-CSG Communication Control Unit.

8-5 Printing

This section describes printing operations.

8-5-1 Items You Can Print

You can print the following items. You can select any of the items to print.

- EtherCAT network configuration and Unit operation settings
- Special Unit parameters settings*¹
- CPU/Expansion Racks*²
- I/O map
- Controller Setup
- Motion Control Setup (axis settings)
- Cam data settings
- Event settings
- Task settings
- Data trace settings
- Programs, functions, and function blocks in Ladder Editor
- Programs, functions, and function blocks in ST Editor
- Local variable tables (programs, functions, and function blocks)
- User-defined data types in Data Type Editor
- Global variable table

*1. This is displayed only for an NJ-series CPU Unit.

*2. This is displayed for NJ-series and NX502, NX102, or NX1P2 CPU Units.



Additional Information

- Refer to *8-16 Troubleshooting* on page 8-120 for information on printing during troubleshooting.
- Refer to *4-11-2 Printing Offline Comparison Results* on page 4-184 for information on printing offline comparison results.
- For device-specific printing functions other than those for Controllers, refer to the manual for the device.

8-5-2 Print Setup



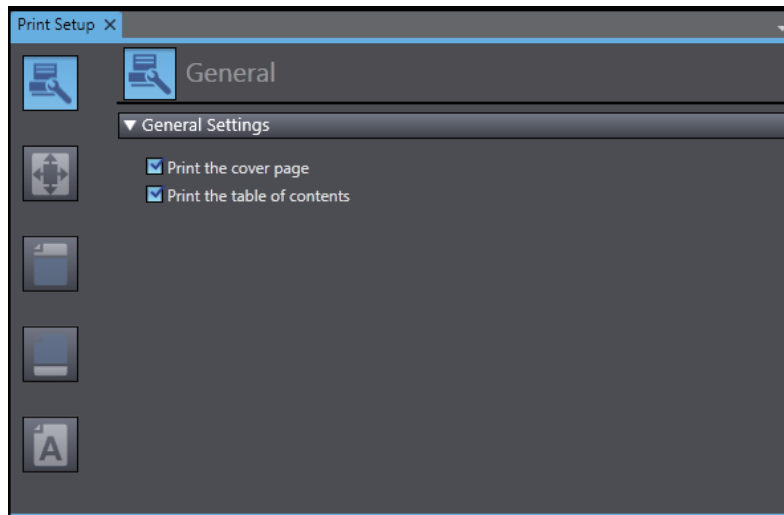

You can specify settings such as whether to print a cover page and table of contents, as well as the margins and font when printing.

Use the following procedure to set up printing.

- 1** Select **Page Settings** from the **File** Menu.
The Print Setup Tab Page is displayed.



- 2 Use the buttons on the left to select the settings.

Button	Icon	Description
General Button		Set whether to print a cover page and table of contents.
Margin Button		Click to set the page margins and header/footer margins.
Header Button		Click to set the header contents.
Footer Button		Click to set the footer contents.
Font Button		Click to set the font to use for printing.

- 3 Specify each setting.

Print Setup Items

This section describes print setup items.

● General

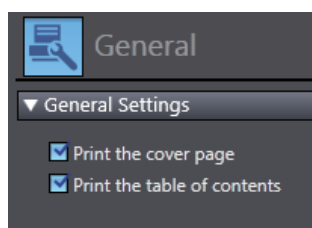

Setup Item	Description
Print the cover page	Set whether to print a cover page. The following items are printed on the cover page. <ul style="list-style-type: none"> • Project name • Project properties • Current Sysmac Studio version
Print the table of contents	Set whether to print a table of contents. The headings and page numbers of the items to print are printed in the table of contents.

● Margin



Setup Item	Description
Margin	Set the top, bottom, left, and right margins of the printed pages.
Header/Footer Margin	Set the margin from the top of the page to the header and the margin from the bottom of the page to the footer.

● Header/Footer

Set the text to print in the header and footer. For each, you can specify the text to print at the left side, center, and right side of the page.

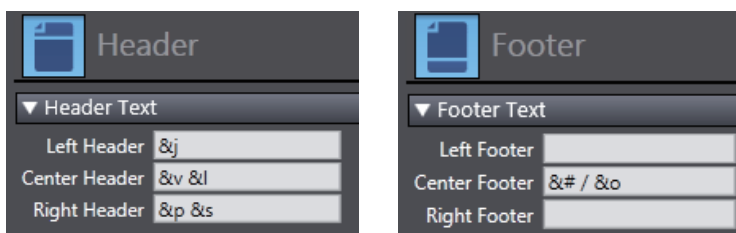

You can use the following field codes in the header and footer.

Item	Field code	Printing example	Remarks
Date	&d	2015/02/24	The printing date is printed.
Time	&t	16:38	The printing time is printed.
Page number	&#	1	---
Total pages	&o	4	---
Printed item	&l	I/O Map	---
Project name	&j	New Project	---
Controller name	&v	new_Controller_0	---
Controller model name	&y	NJ501-1500(1.09)	The model and unit version of the Controller are printed.

Item	Field code	Printing example	Remarks
POU name	&p	Program0	This is printed only on the pages where POU's are printed.
Section name	&s	Section1	This is printed only on the pages where sections are printed.

● Font

Click the **Font Setting** Button and set the font to use when printing in the Font Setting Dialog Box that is displayed. You can set the font type, style, effects, and size.

8-5-3 Printing

Use the following procedure to print.

1 Select **Print** from the **File** Menu.

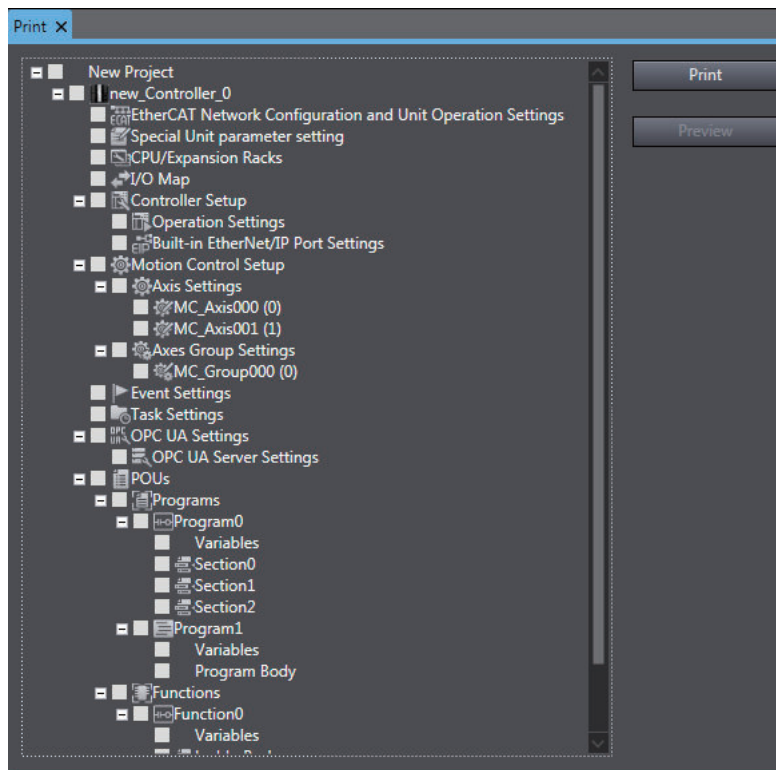

2 Select the check boxes for the items to print.

3 Click the **Print** Button. The **Print** Dialog Box is displayed.

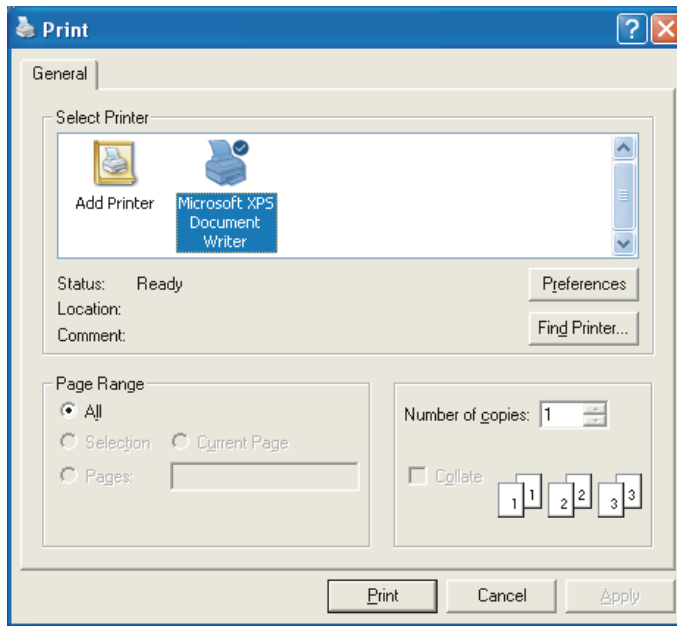

- 4** Select the printer to use, and then click the **Print** Button.
The selected items are printed.
Printing Examples:

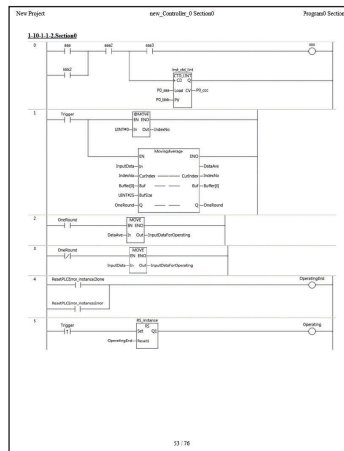
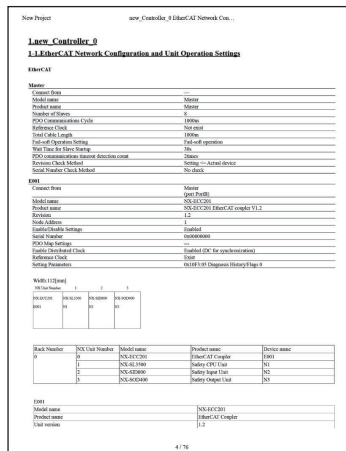

Var. Name	Var. Type	Data Type / V.V.	Initial Value	Access	Comment	Network Variable	Comments
Var_000001	GLOBAL_BOOL	GLOBAL_BOOL	FALSE	False		Do not publish	
Var_000002	GLOBAL_BOOL	GLOBAL_BOOL	FALSE	False		Do not publish	
Var_000003	GLOBAL_BOOL	GLOBAL_BOOL	FALSE	False		Do not publish	
Var_000004	GLOBAL_BOOL	GLOBAL_BOOL	FALSE	False		Do not publish	
Var_000005	GLOBAL_BOOL	GLOBAL_BOOL	FALSE	False		Do not publish	
Var_000006	GLOBAL_BOOL	GLOBAL_BOOL	FALSE	False		Do not publish	
Var_000007	GLOBAL_BOOL	GLOBAL_BOOL	FALSE	False		Do not publish	
Var_000008	GLOBAL_BOOL	GLOBAL_BOOL	FALSE	False		Do not publish	
Var_000009	GLOBAL_BOOL	GLOBAL_BOOL	FALSE	False		Do not publish	
Var_000010	GLOBAL_BOOL	GLOBAL_BOOL	FALSE	False		Do not publish	
Var_000011	GLOBAL_BOOL	GLOBAL_BOOL	FALSE	False		Do not publish	
Var_000012	GLOBAL_BOOL	GLOBAL_BOOL	FALSE	False		Do not publish	
Var_000013	GLOBAL_BOOL	GLOBAL_BOOL	FALSE	False		Do not publish	
Var_000014	GLOBAL_BOOL	GLOBAL_BOOL	FALSE	False		Do not publish	
Var_000015	GLOBAL_BOOL	GLOBAL_BOOL	FALSE	False		Do not publish	
Var_000016	GLOBAL_BOOL	GLOBAL_BOOL	FALSE	False		Do not publish	
Var_000017	GLOBAL_BOOL	GLOBAL_BOOL	FALSE	False		Do not publish	
Var_000018	GLOBAL_BOOL	GLOBAL_BOOL	FALSE	False		Do not publish	
Var_000019	GLOBAL_BOOL	GLOBAL_BOOL	FALSE	False		Do not publish	
Var_000020	GLOBAL_BOOL	GLOBAL_BOOL	FALSE	False		Do not publish	

8-5-4 Print Preview

Use the following procedure to display a print preview.

- 1** Select **Print** from the **File** Menu.
- 2** Select the check boxes for items to display in the print preview.

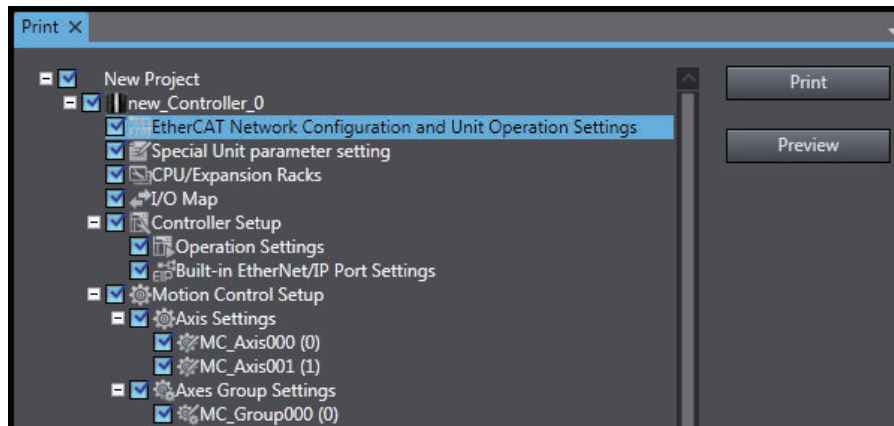

- 3** Click the **Preview** Button.
A printing preview of the selected items is displayed.

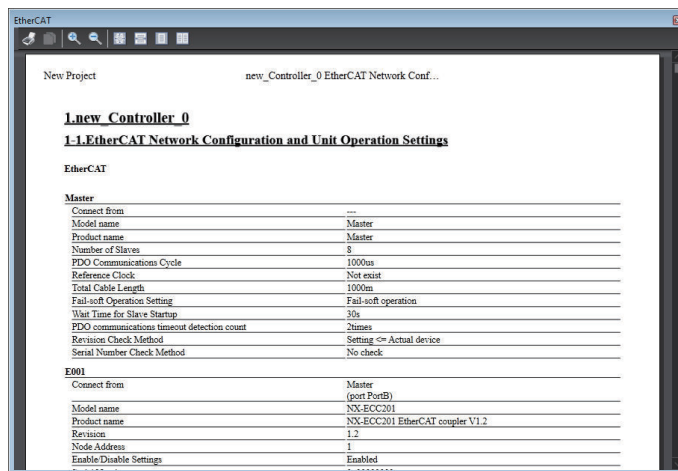

8-6 Clearing Memory

● Clearing Memory

You can use the Clear All Memory menu command to initialize the data in the CPU Unit and mounted Units to the defaults from the Sysmac Studio.

8-6-1 Clearing All Memory of the CPU Unit

The Clear All Memory menu command initializes the user program, Controller Configurations and Setup, variables, and absolute encoder home offsets in the CPU Unit, as well as the data in X Bus Units and NX Units, to the defaults.

● Items Cleared by the Command and Their Status after Clearing Memory

Data		Status after Clear All Memory operation
User program		One program is assigned to the primary periodic task (task period: 4 ms). The program will be empty.
Controller configurations and setup		The default settings are restored. Security information (protection, Secure Communication Version, authority verification, user authentication, etc.) is also initialized.
Variables	System-defined variables	Depends on the type of variable
	Device variables	Clearing the variable tables deletes the device variables.
	User-defined variables	User-defined variables are deleted when the variable tables are cleared.
Absolute encoder home offset		Cleared.
X Bus Units*1		Memory data in all X Bus Units on the CPU Rack is cleared.
NX Units*2		Memory data in all NX Units on the CPU Rack is cleared.

*1. Applicable when X Bus Units are mounted on an NX502 CPU Unit.

*2. Applicable when NX Units are mounted on an NX502, NX102, or NX1P2 CPU Unit.

● Procedure for Clearing Memory

- 1 Go online and select **Clear All Memory** from the **Controller Menu**.
The **Clear All Memory Confirmation** Dialog Box is displayed.

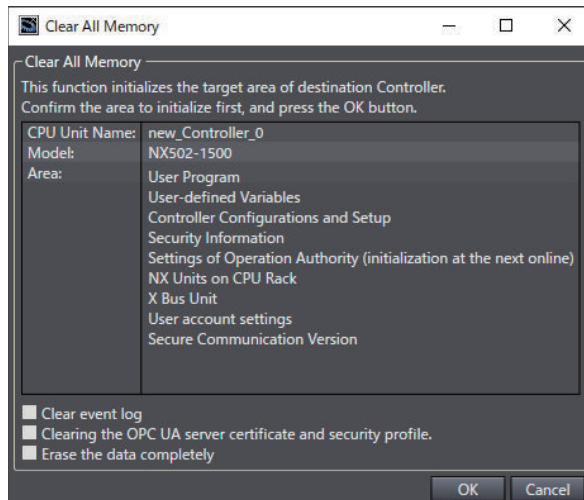

- 2 Check the areas to initialize. Select the option check boxes as needed.
- 3 Click the **OK** Button to clear the memory.
After the memory is cleared, the following dialog box is displayed.

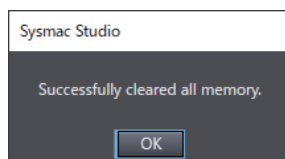

- 4 Click the **OK** Button.
The Clear All Memory Operation cannot be performed in RUN mode.

● Clear All Memory Options

Option	Description
Clear event log	Select this box to clear the event log.
Clearing the OPC UA server certificate and security profile. *1	Select this box to clear the OPC UA server certificate and security profile.
Erase the data completely *2	To prevent data restoration, select this box to have the Clear All Memory function overwrite meaningless data over the area after erasing data. It may take some time to complete the Clear All Memory operation. Selecting this box automatically selects the Clear event log and Clearing the OPC UA server certificate and security profile Check Boxes.

*1. This is displayed only for Controllers that support OPC UA functions. Refer to the *NJ/NX-series CPU Unit OPC UA User's Manual (Cat. No. W588)* for details.

*2. This is displayed only for the following Controllers.

- NJ-series, NX502, NX102, or NX1P2 CPU Unit: Version 1.60 or later
- NX701 CPU Unit: Version 1.32 or later

Refer to the *NJ/NX-series CPU Unit Software User's Manual (Cat. No. W501)* for information on erasing the data completely.

**Precautions for Safe Use**

After you clear the memory, the Controller operates in the same way as immediately after you create the system configuration with the Controller in the factory default condition.

**Precautions for Correct Use**

- The Clear All Memory Operation can be performed only in PROGRAM mode.
- The Clear All Memory Operation cannot be performed when write protection of the CPU Unit is set in the Security Settings. Clear the write protection of the CPU Unit and then perform the Clear All Memory Operation.
- If the user authentication function of the Controller is enabled, a communications error will occur after the completion of the Clear All Memory operation since the user accounts are deleted. To continue the operation, once go offline, go back online again, and then set a new user account. Refer to *8-3-3 User Authentication* on page 8-19 for details on setting new user accounts.
- When the Clear All Memory command is executed, the value of the absolute encoder home offset is cleared.
To retain the value of the absolute encoder home offset before the Clear All Memory operation, use the Controller backup function before you execute the Clear All Memory command. To restore the previous value of the absolute encoder home offset after the Clear All Memory operation, restore the file that were backed up with the Controller backup function. Refer to *8-10-1 Controller Backup Functions* on page 8-71 for details on the Controller backup function.
- The details of NX Unit areas initialized in the Clear All Memory operation and the state after initialization depend on the Unit. Refer to the user's manuals for the CPU Unit and Communications Coupler Unit to which you connect the NX Unit for details.

8-6-2 Clearing All Memory of X Bus Units

Initialize the data in the X Bus Units mounted on the CPU Unit individually.

**Version Information**

An NX502 CPU Unit with unit version 1.60 or later and Sysmac Studio version 1.54 or higher are required to use this function.

● Procedure for Clearing All Memory

- 1** When the Controller is connected online, right-click on the target X Bus Unit and select **Clear All Memory in X Bus Unit**.
The Clear All Memory dialog box is displayed.

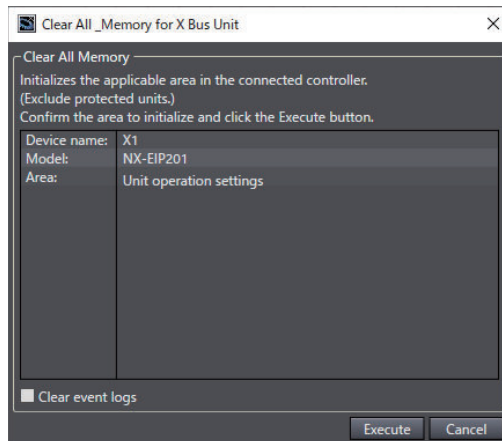

- 2 Check the areas to initialize, and click the **Execute** Button.
The dialog box to confirm execution is displayed.
- 3 Click the **Yes** Button.
The Memory All Clear operation is completed, and the X Bus Unit is restarted.



Precautions for Safe Use

Before executing Clear All Memory in X Bus Unit, make sure that doing so will not adversely affect the controlled system.

● Clear All Memory Options

Option	Description
Clear event log	Select this box to clear the event log.

8-6-3 Clearing All Memory of NX Units

Initialize the data in the NX Units mounted on the CPU Unit or Slave Terminal individually.

● Procedure for Clearing All Memory

The procedure below shows an example for an EtherCAT Coupler Unit.

- 1 When the Controller is connected online, right-click on the target NX Unit and select **Clear All Memory**.
The Clear All Memory dialog box is displayed.

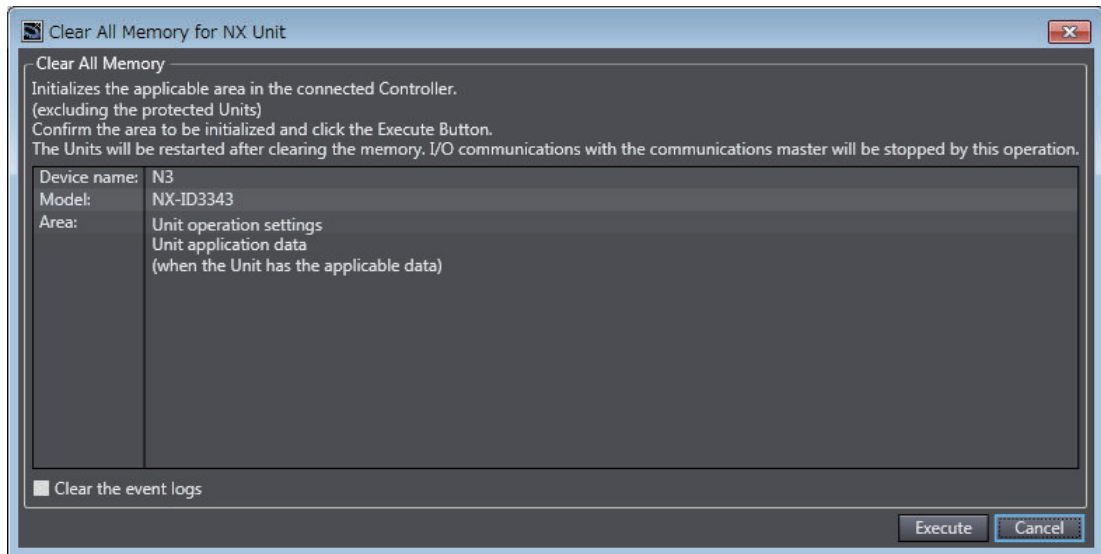

- 2 Check the areas to initialize, and click the **Execute** Button.
A dialog box to confirm execution is displayed.
- 3 Click the **Yes** Button.
The Memory All Clear operation is completed, and the NX Unit is restarted.



Precautions for Correct Use

For NX Units mounted on an NX1P2 CPU Unit, Memory All Clear operation cannot be performed on an individual Unit basis. Clear all memory of the CPU Unit.

● Clear All Memory Option

Option	Description
Clear the event logs	Select this box to clear the event log.

8-6-4 Clear All Memory Operation for the Units in a Slave Terminal

You can initialize the data in specified Units or all of the Units on a Slave Terminal.

- 1 Go online, right-click a Unit on the Slave Terminal Tab Page and select **Clear All Memory**. To perform the Clear All Memory Operation for all of the Units, right-click the Communications Coupler Unit and select **Clear All Memory**.
The Clear All Memory Dialog Box is displayed.

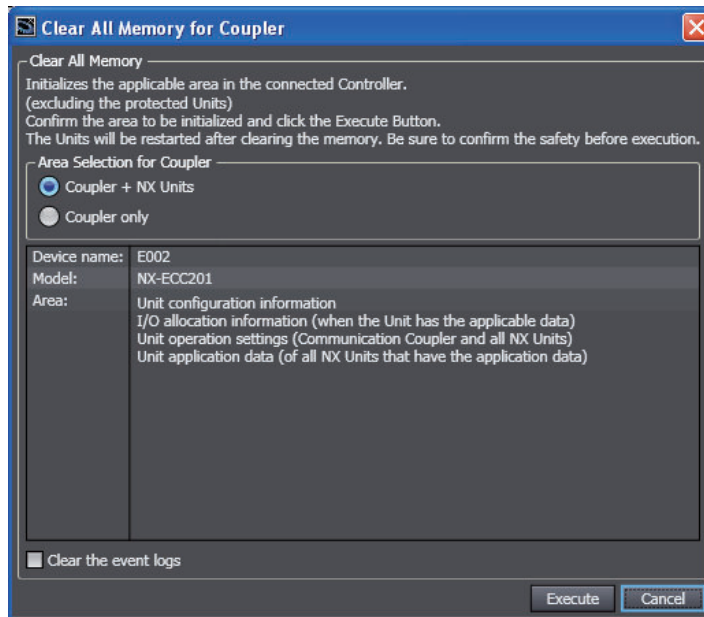

- 2 Check the areas to be initialized and then click the **Execute** Button. To clear the event log, select the Clear the event logs Check Box. To perform the Clear All Memory Operation for all of the Units, select **Coupler + NX Units** for the *Area Selection for Coupler*. A confirmation dialog box is displayed.
- 3 Click the **Yes** Button.
The Units will be restarted when the Clear All Memory Operation is completed.



Precautions for Correct Use

- Refer to the user's manual for the Communications Coupler Unit for details on the areas initialized in the Clear All Memory operation and the state after initialization.
- The Units are restarted after the Clear All Memory Operation is completed. This will cause I/O communications with the communications master to stop. What is restarted depends on what memory is cleared and the unit version of the Communications Coupler Unit. Refer to the user's manual for the Communications Coupler Unit for details.

8-7 Releasing Access Rights

● Releasing Access Rights

Access rights may be retained by the Controller if the online connection is abnormally broken between the Controller and the Sysmac Studio. In this case, normally access from the Sysmac Studio is no longer possible.

Use the Sysmac Studio to release the access rights in the Controller.

● Procedure for Releasing Access Rights

- 1 Select **Release Access Right** from the **Controller** Menu.

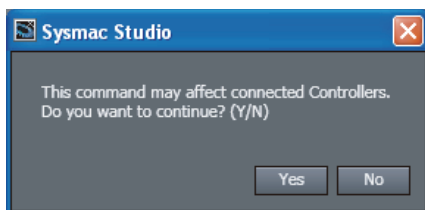

- 2 Click the **Yes** Button.
The following dialog box is displayed when the access rights are released.

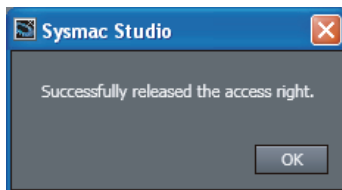

- 3 Click the **OK** Button.

8-8 Displaying Unit Production Information

You can display the production information on the CPU Unit, the Units mounted on the CPU Unit, or EtherCAT slaves in the Production Information Dialog Box. Production information refers to the model, version, lot number, and other information.

The following describes the common operations to screens and the displayed items for each Unit.

Dialog Box

The Production Information Dialog Box has the outline view and the detail view.

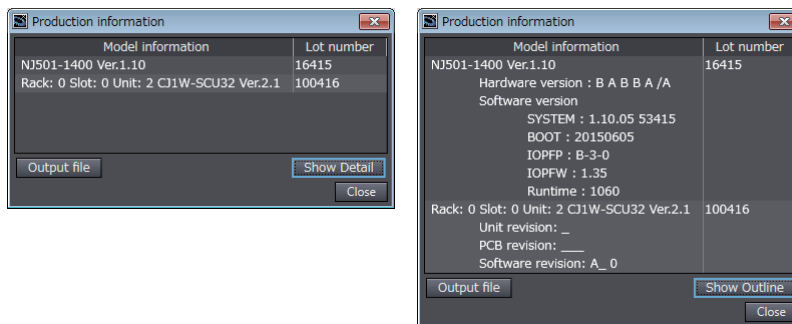

Outline View

Detail View

Click the **Show Outline** Button or the **Show Detail** Button to change between the outline and detail views.

Output File

You can save production information to a file.

- 1 Click the **Output file** Button in the Production Information Dialog Box. The **Save File** Dialog Box is displayed.
- 2 Enter a file name, and then click the **Save** Button. A file with a .csv extension is saved.

8-8-1 Displaying CPU Unit Production Information

NX/NY-series Controllers

Use the following procedure to display the production information on the CPU Unit or Industrial PC. If X Bus Units and NX Units are mounted on it, the production information on each Unit is displayed. For the NX1P2 CPU Unit, the production information on Option Boards is also displayed.

● Display Method

- 1 Right-click **CPU Rack** under **CPU/Expansion Racks** in the Multiview Explorer and select **Display Production Information**.

The Production Information Dialog Box is displayed.

● Displayed Items

The following items are displayed.

CPU Unit/Industrial PC	X Bus Unit ^{*1} /NX Unit ^{*2}	Option Board ^{*3}
<ul style="list-style-type: none"> • Model number and Unit version • Lot number • Serial number • Hardware revision • Software version • Total power-ON time^{*4} 	<ul style="list-style-type: none"> • Model number and Unit version • Lot number • Serial number • Hardware version • Software version • Total power-ON time 	<ul style="list-style-type: none"> • Model number and Unit version • Lot number • Serial number • Hardware version • Software version

*1. This is displayed only when X Bus Units are mounted on an NX502 CPU Unit.

*2. This is displayed only when NX Units are mounted on an NX502, NX102, or NX1P2 CPU Unit.

*3. This is displayed only when Option Boards are mounted on an NX1P2 CPU Unit.

*4. This is displayed only for an NX502, NX102, or NX1P2 CPU Unit.

Refer to the manual for the specific Unit for details on the displayed items.

NJ-series Controllers

Use the following procedure to display the production information on the CPU Unit and CJ-series Special Units.

● Display Method

- 1 Double-click **CPU/Expansion Racks** under **Configurations and Setup** in the Multiview Explorer. Or, right-click **CPU/Expansion Racks** under **Configurations and Setup** and select **Edit** from the menu.

The Unit Editor is displayed in the Edit Pane.

- 2 Right-click any location where there is no Unit in the Unit Editor and select **Production Information**.

The Production Information Dialog Box is displayed.

● Displayed Items

The following items are displayed.

CPU Unit	CJ-series Special Unit
<ul style="list-style-type: none"> • Unit model number and unit version • Lot number • Hardware version and hardware revision^{*1} • Software version 	<ul style="list-style-type: none"> • Rack number, slot number, and unit number • Unit model number and unit version • Lot number • Unit revision • PCB revision • Software revision

*1. The hardware revision is not displayed for the Unit that the hardware revision is in blank.

Refer to the manual for the specific Unit for details on the displayed items.

8-8-2 Displaying EtherCAT Slave Production Information

Use the following procedure to display the node addresses, models,^{*1} and the Serial ID that are set in the EtherCAT slaves.

*1. If the model of a slave cannot be determined (e.g., if there is no ESI file), the vendor ID, product code, and revision number are displayed.

● Display Method

- 1** Double-click **EtherCAT** under **Configurations and Setup** in the Multiview Explorer. Or, right-click **EtherCAT** under **Configurations and Setup** and select **Edit** from the menu.
The EtherCAT Tab Page is displayed in the Edit Pane.
- 2** Right-click the master in the EtherCAT Tab Page and select **Display Production Information**.
The Production Information Dialog Box is displayed.

● Displayed Items

The following items are displayed.

- Model number and revision
- Serial number
- Hardware version
- Software version

Refer to the manual for the specific slave for details on the displayed items.

8-8-3 Displaying Production Information for Configuration Units in EtherCAT Slave Terminals

Use the following procedure to display the production information in Units mounted on an EtherCAT Slave Terminal.

● Display Method

- 1** Double-click the EtherCAT Coupler Unit under **EtherCAT** in the Multiview Explorer. Or, right-click the EtherCAT Coupler Unit under **EtherCAT** and select **Edit** from the menu.
The Slave Terminal Tab Page is displayed in the Edit Pane.
- 2** Right-click in the Slave Terminal Tab Page and select **Display Production Information** from the menu.
The Production Information Dialog Box is displayed.

● Displayed Items

The following items are displayed.

- Model number and Unit version
- Lot number
- Serial number
- Hardware version

- Software version
- Total power-ON time

Refer to the manual for the specific Unit for details on the displayed items.

8-9 Firmware Update Log

You can confirm the firmware update log in the Controller. For details on firmware updates, please contact OMRON sales representatives.

● Displaying the Firmware Update Log

This function can be used only when connecting online to the Controller.

- 1 Select **Firmware Update Log** from the **Controller Menu**.
The **Firmware Update Log** Dialog Box is displayed.

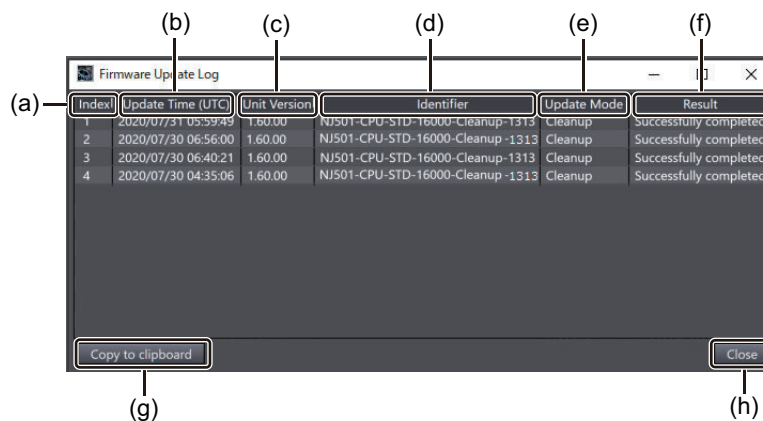

No.	Item	Description
(a)	Index	Displays the order of updates. The most recent log event is 1.
(b)	Update Time (UTC)	Displays the time when the firmware update was executed. The time is logged in Coordinated Universal Time (UTC).
(c)	Unit Version	Displays the firmware version.
(d)	Identifier	Displays system information stored in the Firmware Updater.
(e)	Update Mode	Displays the firmware update mode.
(f)	Result	Displays the result of the firmware update.
(g)	Copy to clipboard Button	Copies the firmware update log data to the clipboard.
(h)	Close Button	Closes the Firmware Update Log Dialog Box.

Refer to the *NJ/NX-series CPU Unit Software User's Manual (Cat. No. W501)* for details on each item.

8-10 Backup Functions

With the backup functions, you can back up, restore, and compare the user program and other NJ/NX/NY-series Controller data to replace hardware, such as the CPU Unit, or to restore device data. The following functions are supported.

Function	Description
Controller backup functions* ¹	You can back up, restore, or compare all of the data in the Controller.
SD Memory Card backup functions* ¹	You can back up all of the data in the Controller to an SD Memory Card mounted on an NJ/NX-series Controller or to a Virtual SD Memory Card in an NY-series Controller, and compare the data.
Variable and memory backup functions* ²	You can back up and restore the contents of retained memory locations in the Controller.
Importing and exporting backup files	You can import backup files from Controller backups or SD Memory Card backups to projects on the Sysmac Studio or export data from projects on the Sysmac Studio to backup files.

*1. A CPU Unit with unit version 1.03 or later and Sysmac Studio version 1.04 or higher are required.

*2. The data that is backed up for variable and memory backup is included in the data that is backed up for Controller backups.

Refer to the *NJ/NX-series CPU Unit Software User's Manual (Cat. No. W501)* or *NY-series Industrial Panel PC / Industrial Box PC Software User's Manual (Cat. No. W558)* for details on the backup functions, the applicable models for the backup functions, and the data that is backed up and restored.

CAUTION

Always confirm safety at the destination node before you transfer a user program, configuration data, setup data, device variables, or values in memory used for CJ-series Units from the Sysmac Studio. The devices or machines may perform unexpected operation regardless of the operating mode of the CPU Unit.



Precautions for Safe Use

- The *absolute encoder home offsets* are stored in the Controller and backed up by a Battery as absolute encoder information. If any of the following conditions is met, clear the absolute encoder home offsets from the list of data items to restore, and then restore the data. Then, define home again. If you do not define home, unintended operation of the controlled system may occur.
 - a) The Servomotor or Servo Drive was changed since the data was backed up.
 - b) The absolute encoder was set up after the data was backed up.
 - c) The absolute data for the absolute encoder was lost.
- When you restore only part of the data that was backed up, confirm that no problems will occur if you do not restore all of the backup data. Otherwise, malfunction of the device may occur.
- If inappropriate backup data is set when you restore backup data to a Unit, unexpected machine operation may result. Confirm that the machine will not be adversely affected before you transfer the data.
- The performance may be different if the hardware revisions are different. Before you transfer the user program, data, and parameter settings to the CPU Units with the different hardware revisions, check them for proper execution and then use them for actual operation.

8-10-1 Controller Backup Functions

You can back up the data from the Controller to a file and restore the contents of the backup file. Refer to the *NJ/NX-series CPU Unit Software User's Manual (Cat. No. W501)* or *NY-series Industrial Panel PC / Industrial Box PC Software User's Manual (Cat. No. W558)* for details on the backup functions, the applicable models for the backup functions, and the data that is backed up and restored.

Backing Up Data

- 1 Connect the Sysmac Studio to the Controller to back up, and then select **Backup – Backup Controller** from the **Tools** Menu.

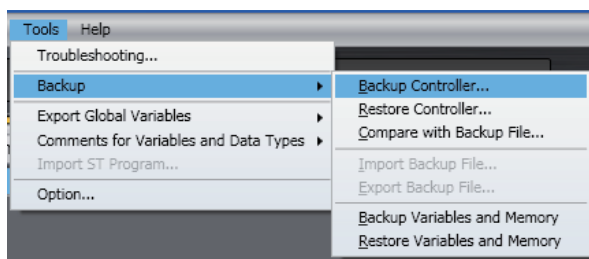

A dialog box is displayed for you to specify the folder in which to save the backup file.

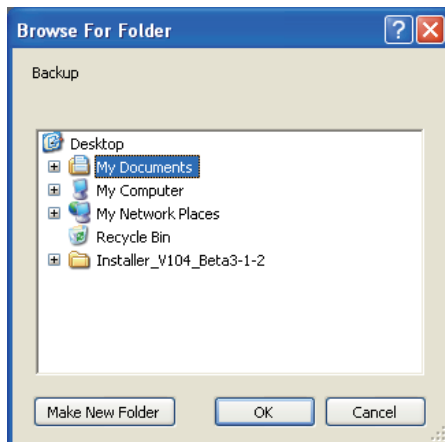

- 2 Select the folder and then click the **OK** Button.
The Backup Dialog Box is displayed.
Example for an NJ-series Controller

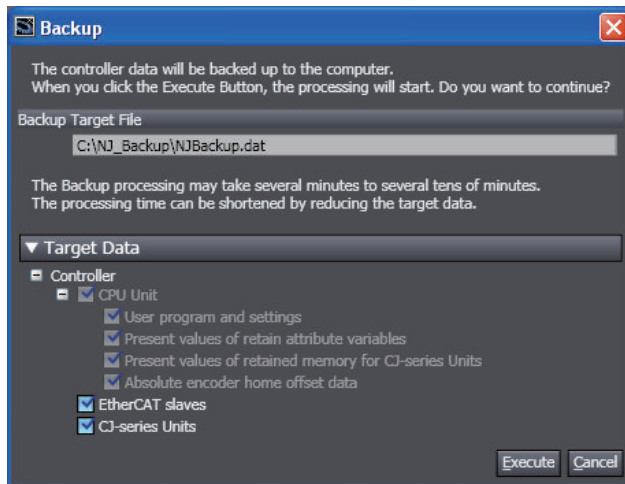

- 3 Select the data to back up, and then click the **Execute** Button.

The backup is started.

When the backup is completed, a Verification Confirmation Dialog Box is displayed.

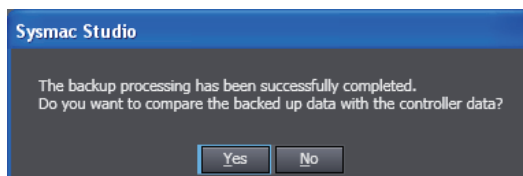

If you click the **Yes** Button, a dialog box is displayed to confirm the data to compare. Refer to *Verifying Data*, below, for the verification procedure.



Additional Information

- The backup file name is automatically determined for the Controller for which the data is backed up. You cannot change the file name.
- Backup files are not compatible between different series of Controllers.

Restoring Data

Before you restore data, change the operating mode of the Controller to PROGRAM mode.

- 1 Connect the Sysmac Studio to the Controller to restore, and then select **Backup – Restore Controller** from the **Tools** Menu.

A dialog box is displayed to select the folder in which the backup file is saved to restore the data.

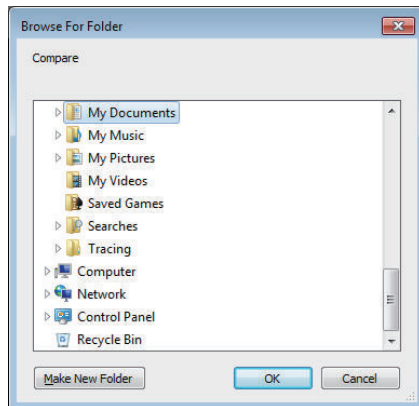

- 2** Select the folder and then click the **OK** Button.
The Restore Dialog Box is displayed.
Example for an NJ-series Controller

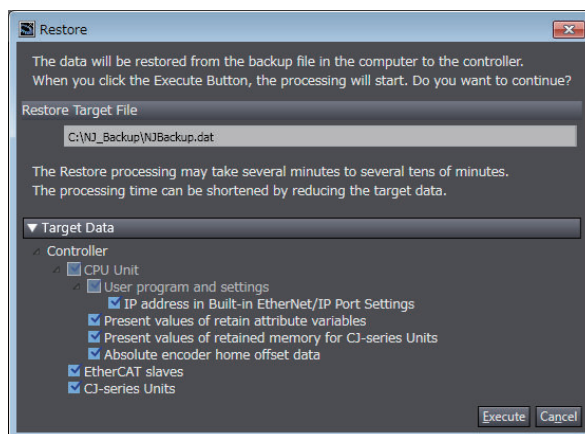

- 3** Select the data to restore, and then click the **Execute** Button.
The restoration operation is started and the execution progress is displayed.
When the execution progress display disappears, the restoration operation is completed.



Precautions for Correct Use

- If the model number or unit version of the CPU Unit of the Controller is not the same as those of the Controller from which the backup file was created, a confirmation dialog box is displayed. Confirm that the Controller is the correct one before you restore the data.
- If restoring the data results in changing the IP address of the EtherNet/IP port, communications may be disconnected. Confirm that the system will not be adversely affected even if the IP address changes before you restore the data.
If the Sysmac Studio is connected to a Controller with unit version 1.14 or later, you can remove the IP address settings for the built-in EtherNet/IP port from the restore target data. To do so, clear the **IP address in Built-in EtherNet/IP Port Settings** Check Box under **Target Data**. Refer to the *NJ/NX-series CPU Unit Software User's Manual (Cat. No. W501)* or *NY-series Industrial Panel PC / Industrial Box PC Software User's Manual (Cat. No. W558)* for details.
- You cannot cancel the operation after you have started to restore the data.

Verifying Data

- 1 Connect the Sysmac Studio to the Controller for which to compare the data, and then select **Backup – Compare with Backup File** from the **Tools** Menu.
A dialog box is displayed to select the folder in which the backup file is saved to compare the data.

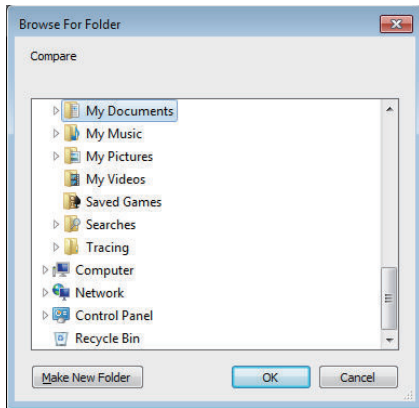

- 2 Select the folder and then click the **OK** Button.
The Compare Dialog Box is displayed.
Example for an NJ-series Controller

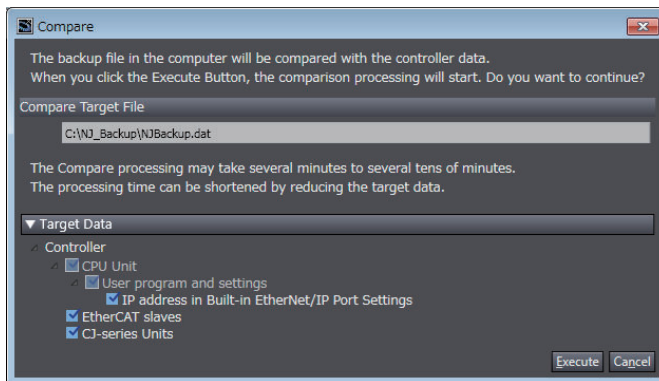

- 3 Select the data to compare, and then click the **Execute** Button.
The comparison is started.
The comparison results are displayed in the Output Tab Page after the comparison is completed.

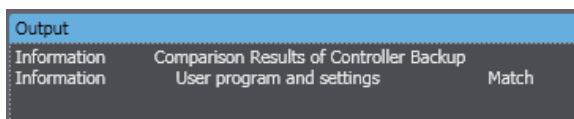

8-10-2 SD Memory Card Backup Functions

With the SD Memory Card backup functions, you can use SD Memory Cards or Virtual SD Memory Cards to back up, restore, and verify Controller data. These functions are supported by the Controller itself. You can also execute SD Memory Card backups and verifications on the Sysmac Studio. Refer to the *NJ/NX-series CPU Unit Software User's Manual (Cat. No. W501)* or *NY-series Industrial Panel PC / Industrial Box PC Software User's Manual (Cat. No. W558)* for details on the data that is backed up and the procedure to restore the data.

Backing Up Data

- 1 In the SD Memory Card Window, display the folder in which to create the backup file and then click the SD Memory Card Backup Button () on the toolbar. The SD Memory Card Backup Dialog Box is displayed.

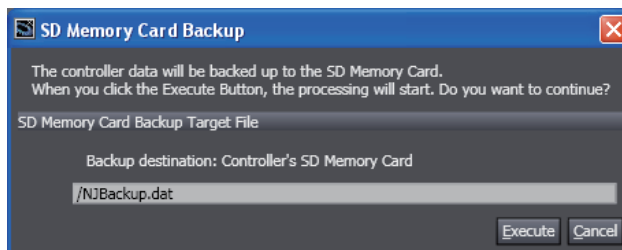

- 2 Click the **Execute** Button. The backup is started. When the backup is completed, a Backup Completed Dialog Box is displayed.

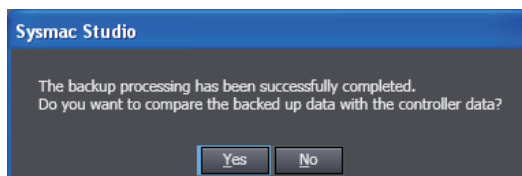

Precautions for Correct Use

You cannot backup data when data is already being backed up, restored, or compared for the same Controller. An error message is displayed and the process is not performed.



Additional Information

The backup file name is automatically determined for the Controller for which the data is backed up. You cannot change the file name.

Verifying Data

- 1 In the SD Memory Card Window, display the file that contains the data to compare and then click the Compare SD Memory Card Backup Button () on the toolbar. The Compare SD Memory Card Backup Dialog Box is displayed.

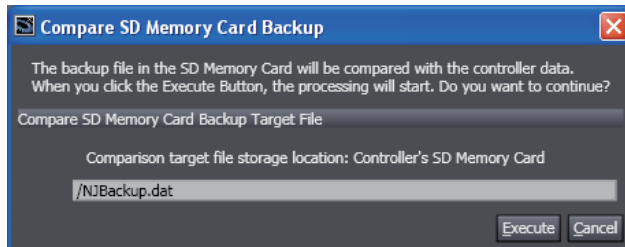

- 2 Click the **Execute** Button. The comparison is started. The comparison results are displayed in the Output Tab Page after the comparison is completed.

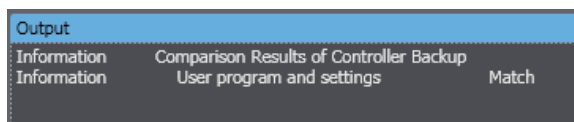

8-10-3 Backing Up Variables and Memory

● Backing Up Variables and Memory

When you replace an NJ/NX/NY-series Controller, you can back up the retained memory in the Controller to a file and restore the backed up data from the file to the new Controller.



Precautions for Correct Use

- Store and manage the variable/memory backup file and the project file used to create it as a set.
- You can also use the variable/memory backup file to restore memory from a copy of the project file used to create it, or even if the name of the project file is changed.
- If you change a variable, delete a variable, or otherwise edit a backed up variable in the project file used to create the backup, that variable is not restored to memory. The information on variables or memory that was not restored is recorded as errors.



Additional Information

If you add members of structure variables and transfer them to a CPU Unit with unit version 1.10 or earlier, the present values of existing members of structure variables are initialized. You can restore the present values of the members by backing up the present values of the structure variables with a Retain attribute before you download the new members, and then selecting the structure variables to restore afterward and restoring the present values. Select the Present value of Retain attribute variables Check Box.

For CPU Units with unit version 1.11 or later, the present values of existing members of structure variables are retained. For details on the retention operation for present values, refer to the *NJ/NX-series CPU Unit Software User's Manual (Cat. No. W501)* or *NY-series Industrial Panel PC / Industrial Box PC Software User's Manual (Cat. No. W558)*.

Backup Data

You can back up or restore following retained memory.

● Contents of the Retained Memory of the Connected Controller

Type of retained memory	Description	Remarks
Present values of Retain attribute variables	The values of retained variables defined in the Sysmac Studio	You can individually select the variables to back up.
Present values in the DM, EM, and Holding Memory area used for CJ-series Units*1	Data in the DM, EM, and Holding Memory area that can be assigned to CJ-series Special Units in NJ-series CPU Units	The entire memory areas are backed up.
	Values in the DM, EM, and Holding Memory area that are assigned in the CJ-series Unit memory settings for an NX102 Controller	The entire areas that are configured as the memory used for CJ-series Units are backed up.
	Values in the DM and Holding Memory area that are assigned in the CJ-series Unit memory settings for an NX1P2 Controller	
	Values in the DM, EM, and Holding Memory area that are assigned in the CJ-series Unit memory settings for an NX502 Controller	
Absolute encoder home offset value	Compensation value that was tuned with the absolute encoder	Data is not backed up for NJ101-90□□ CPU Units.

*1. This is displayed only for an NJ-series, NX502, NX102, or NX1P2 Controller.

Backing Up Data

● Procedure

- 1 Select **Backup – Backup Variables and Memory** from the **Tools** Menu on the Sysmac Studio.

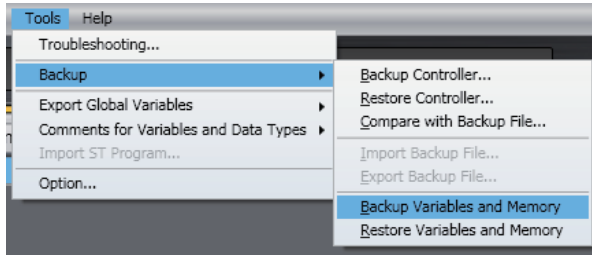

The Backup Dialog Box is displayed.

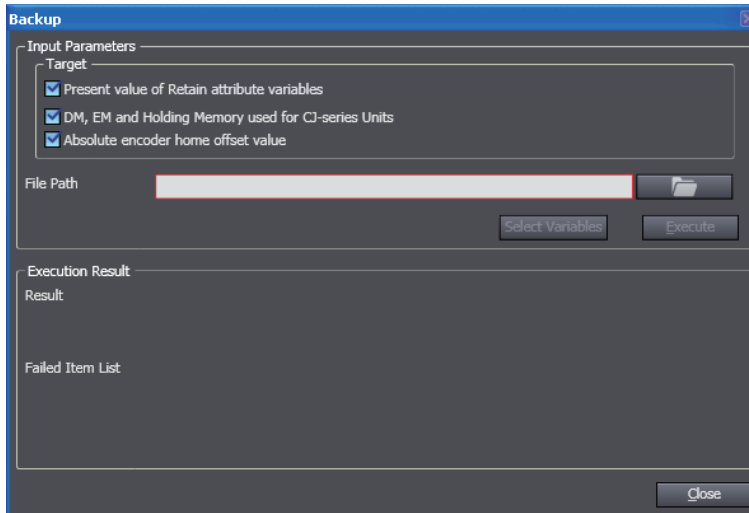

- 2 Select the check boxes for the memory items to back up.
- 3 Click the **View File Selection Dialog Button** (). The **Save As** Dialog Box is displayed. Specify the file path name and file name.
If you select the **Present value of Retain attribute variables** Check Box as a backup target, you can select the target variables using the **Select Variables** Button. Refer to *Selecting the Retained Variables to Back Up* on page 8-81 for details.
And if you select only the **Present value of Retain attribute variables** Check Box, besides XML, you can select CSV as a file format.
You can change the values of the retained variable by editing the saved CSV file. Refer to *Editing the Values of the Retained Variables That Were Backed Up* on page 8-82 for details.
- 4 Click the **Execute** Button. The variables are backed up.
When the backup is completed, the results are displayed in the Execution Result Area.



Additional Information

- To back up the data, the contents of the NJ/NX/NY-series Controller and the project must match. If it does not match, stop the backup and synchronize the data to make it match.
- With Sysmac Studio version 1.05 or higher, you can start a backup when changes are added after unifying the data by executing synchronization.
- With the following conditions, only the present value of a member with the largest data size can be the union backup data.
 - a) Sysmac Studio version 1.25 or higher
 - b) Comparison results between contents of the projects in the Sysmac Studio and the NJ/NX/NY-series Controller match.

Restoring Data

● Restore Procedure

- 1 Select **Backup – Restore Variables and Memory** from the **Tools** Menu on the Sysmac Studio.

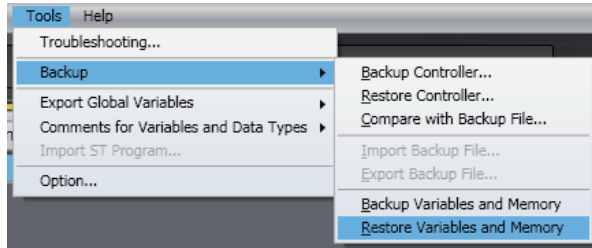

The Restore Dialog Box is displayed.

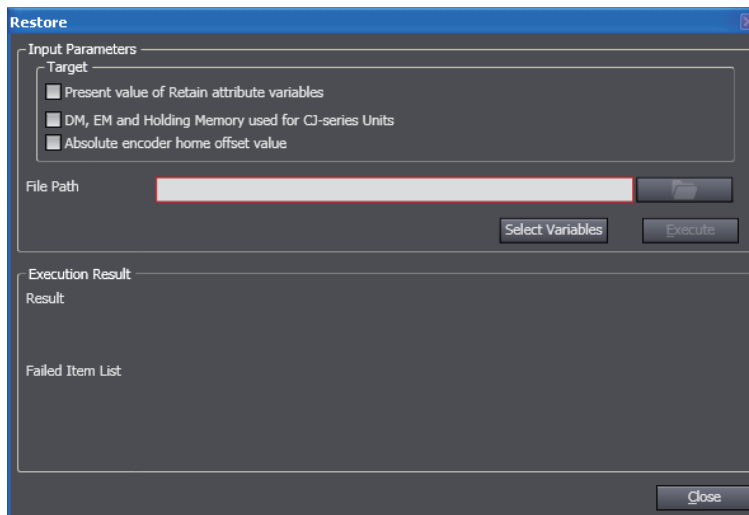

- 2 Select the check boxes for the items to restore.
- 3 Click the **View File Selection Dialog** Button (). The **File Selection** Dialog Box is displayed. Specify the file path.
- 4 To select the retained variables for which to restore the present values, click the **Select Variables** Button.
A list of retained variables is displayed in the Select Variables Dialog Box.

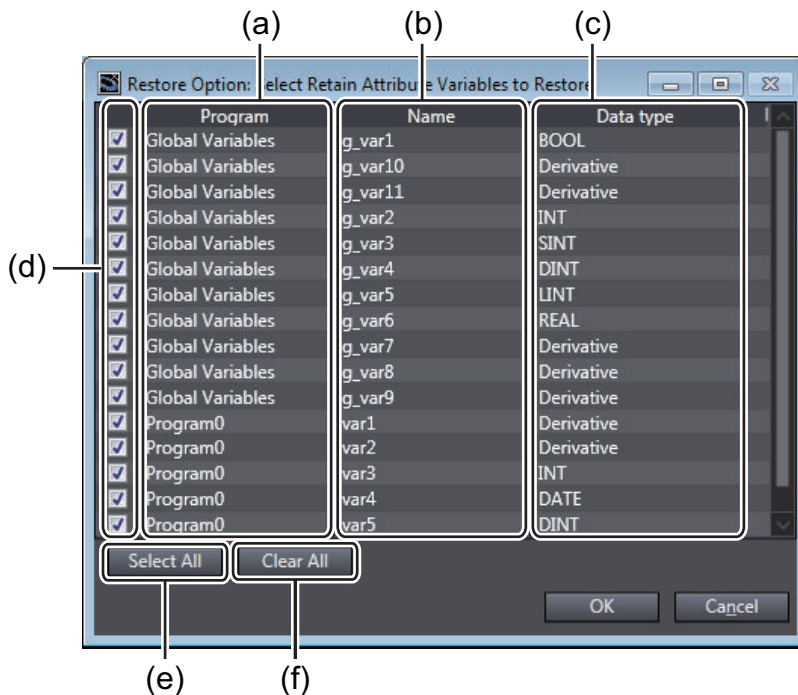

Item	Description
(a) Program	The group to which the retained variables that are read from the backup file belong (global variable table or programs) is displayed. These fields will be empty if the programs were deleted from the project or the program names were changed since the data was backed up.
(b) Name	The names of the retained variables read from the backup file are displayed.
(c) Data type	The data types of the retained variables in the backup file are displayed. <i>Derivative</i> is displayed for array and structure variables.
(d) Check boxes	Select the check boxes for the retained variables to restore.
(e) Select All	The check boxes for all variables are selected.
(f) Clear All	All of the selections are cleared.

Select the variables to restore, and then click the **OK** Button.

5 Click the **Execute** Button. The variables are restored.

When the restore operation is completed normally, the results are displayed in the Execution Results Text Display Area. In addition, cycle the power supply to the Controller, or reset the Controller, to reflect the results of the restored data.

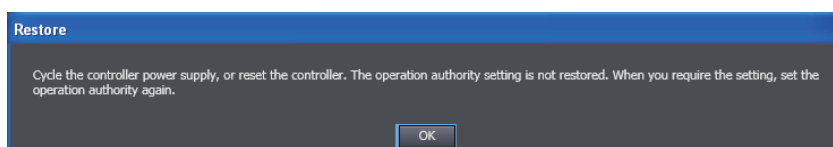

If the restore operation fails, the data names of the data that was not restored are shown in the **Failed Item List** Text Box.



Additional Information

- To restore the backup, the contents of the NJ/NX/NY-series Controller and the project must match. If it does not match, stop the restore process and synchronize the data to make it match.
- With Sysmac Studio version 1.05 or higher, you can execute a restore operation when changes are added after unifying the data by executing synchronization.
- In Sysmac Studio version 1.17 or higher, the following restrictions apply to mutual use of data between the *Backup Variables and Memory* and *Transfer All Variable Present Values* functions.
 - a) Although the *Transfer All Variable Present Values* function outputs the values of all variables to a file, the *Restore Variables and Memory* function targets only the values of retained variables.

Selecting the Retained Variables to Back Up

Select the retained variables to back up during the backup operation.

- 1 Select the **Present value of Retain attribute variables** Check Box in the Backup Dialog Box. The **Select Variables** Button is enabled.
- 2 Click the **Select Variables** Button. The Select Variables Dialog Box is displayed.

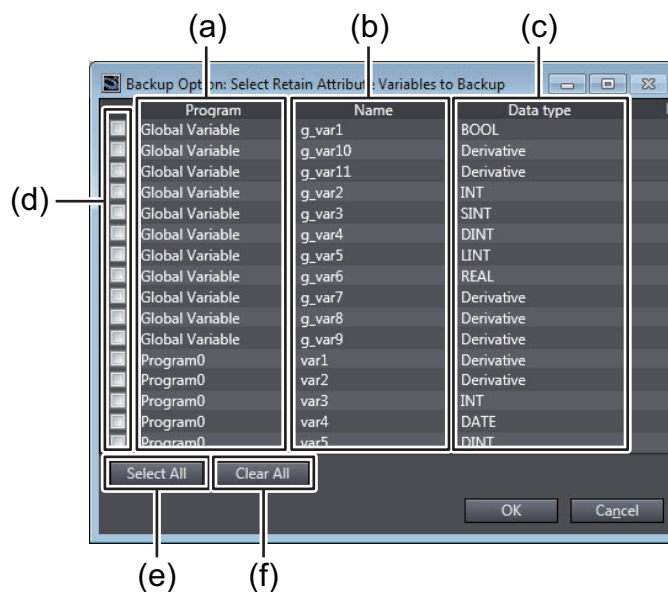

Item	Description
(a) Program	The group to which the retained variable belongs (global variable table or programs) is displayed.
(b) Name	The names of the retained variables in the project are displayed.
(c) Data type	The data types of the retained variables are displayed. <i>Derivative</i> is displayed for array and structure variables.
(d) Check boxes	Select the check boxes for the retained variables to back up.
(e) Select All	The check boxes for all variables are selected.
(f) Clear All	All of the selections are cleared.

- 3 Select the variables to back up, and then click the **OK** Button.

Editing the Values of the Retained Variables That Were Backed Up

When you back up the value of retained variables in CSV format, you can edit them with spreadsheet software.

You can change the value of backed up retained variables and save them to use as recipe data.

After you edit the file with spreadsheet software, save it in CSV format.

This section uses a sample to describe the items when a file is opened in spreadsheet software.

	A	B	C	D	E	F	G	H	I	J
(a)	1	ja-JP								
(b)	2	acbc932d-df1e-45c0-98cf-0096990653a4								
(c)	3	-								
	4	Program0	VAR://dbda46619e0d416db2b72affc9408ded/In1							
	5		(BOOL)							
	6		FALSE							
(d)	7	-								
	8	gControl1	VAR://gControl1							
(e)	9		status/(BOOL) discription/(STRING[256]) code/(INT)							
	10		FALSE TEST							
(f)	11	-								
	12	gRead1	VAR://gRead1							
(h)	13		(BYTE)							
	14	[0]	1							
	15	[1]	2							
	16	[2]	3							
	17	[3]	4							
(g)	18	[4]	5							
	19	[5]	6							
	20	[6]	7							
	21	[7]	8							
	22	[8]	9							
	23	[9]	10							
	24	-								
	25	gElemets1	VAR://gElemets1							
	26		[*,0]/arg/(INT) [*,0]/detail/(STRING[256]) [*,1]/arg/(INT[*,1]/detail/ [*,2]/arg/(IN[*,2]/detail/ [*,3]/arg/(IN[*,3]/detail/ [*,4]/arg/(IN							
	27	[0,*]	1 TEST	10		1 TEST	0		0	
	28	[1,*]	2 TEST	9		2 TEST	0		0	
	29	[2,*]	3 TEST	8		3 TEST	0		0	

	Item	Description	Editable
(a)	Language information	Gives the language information from when the file was created.	No
(b)	Header information	Gives the project ID when the data was backed up.	No
(c)	Separator	Gives the separator between variables.	No
(d)	Variable name	Gives the variable name.	No
(e)	Variable information	Gives the variable ID.	No
(f)	Variable column header	Gives the data type of the variable. For a structure variable, gives the member name and data type. For an array variable with two or more dimensions, gives the array element position, structure member name, and data type for dimensions 2 and higher.	No
(g)	Variable row header	For an array variable, gives the element number.	No
(h)	Variable value	Gives the value of the variable.	Yes



Precautions for Correct Use

- Do not change anything other than the values of the variables. If you change anything else, it may not be possible to restore the data.
- Enter the values of the variables within the predefined range and format for each data type. If you enter any values incorrectly, you cannot restore the data. Refer to the *NJ/NX-series CPU Unit Software User's Manual (Cat. No. W501)* or *NY-series Industrial Panel PC / Industrial Box PC Software User's Manual (Cat. No. W558)* for information on the ranges and formats of the data types.
- Observe the following precaution if you change the values of TIME_OF_DAY variables in Excel.

The values of TIME_OF_DAY variables are saved in the following format in CSV files:

hh:mm:ss.tt (Where, hh: hours, mm: minutes, ss: seconds, and tt: milliseconds)

If you open a CSV file in Excel, the values of TIME_OF_DAY variables are displayed in the following format:

mm:ss (Where, mm: minutes and ss: seconds)

If you save the file in this state, you will lose the data for hours and milliseconds, and an error will occur for the TIME_OF_DAY variable when you restore the data. To prevent this, change the display format for the values of TIME_OF_DAY variables to *hh:mm:ss.tt* before you save the file.

Restoring Data to Different Controller Models

You can restore data that was backed up on one Controller to another compatible Controller model. You can restore the types and range of data that are supported by the restore destination Controller. If you select an XML or CSV file that was backed up on a different Controller model during the restore operation, you can select only the check boxes for data that can be restored.

● Whether Data Can Be Restored to Different Controller Models

Data that can be restored to different Controllers depends on the Controller model.

The table below shows whether or not you can restore data that was backed up on each Controller to different Controller models.

Controller on which backup file was created	Data to restore	Restore destination Controller		
		NX701 Controller, NY-series Controller	NX502, NX102, or NX1P2 Controller	NJ-series Controller
NX701 Controller, NY-series Controller	Present values of retained variables	OK	OK	OK
	Absolute encoder home offset data ^{*1}	OK	OK	NG
NX502, NX102, or NX1P2 Controller	Present values of retained variables	OK	OK	OK
	Present values in the DM, EM, and Holding Memory area used for CJ-series Units ^{*2*3}	NG	OK ^{*3}	OK
	Absolute encoder home offset data ^{*1}	OK	OK	NG

Controller on which backup file was created	Data to restore	Restore destination Controller		
		NX701 Controller, NY-series Controller	NX502, NX102, or NX1P2 Controller	NJ-series Controller
NJ-series Controller	Present values of retained variables	OK	OK	OK
	Present values in the DM, EM, and Holding Memory area used for CJ-series Units ^{*2}	NG	OK ^{*3}	OK
	Absolute encoder home offset data ^{*1*4}	NG	NG	OK

- *1. If the number of enabled axes in the backup file exceeds the number of axes supported by the restore destination Controller, only the data corresponding to the number of axes supported by the restore destination Controller will be restored.
- *2. If the size of memory used for CJ-series Units in the backup file exceeds the size supported by the restore destination Controller or the size set for the Controller, only the data corresponding to the size supported by or set for the Controller will be restored.
- *3. For NX1P2 Controllers, present values in the DM and Holding Memory area will be restored.
- *4. This data is not contained in the backup file for NJ101-90□□ CPU Units.



Precautions for Correct Use

In Sysmac Studio version 1.16 or lower, you can use only CSV files to restore data to different Controller models. You cannot use XML files.

8-10-4 Importing/Exporting Backup Files

On the Sysmac Studio, you can import a backup file that was saved with the Controller backup function to a new project, or you can export a backup file from a project that can be used to restore data to a Controller.

Importing Backup Files

- 1 Select **Backup – Import Backup File** from the **Tools** Menu.

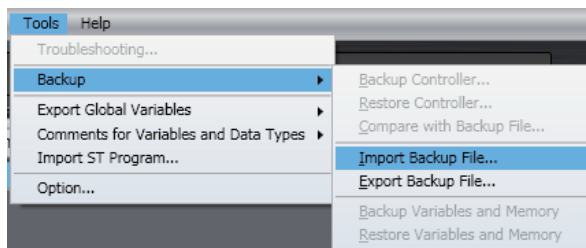

The Browse for Folder Dialog Box is displayed.

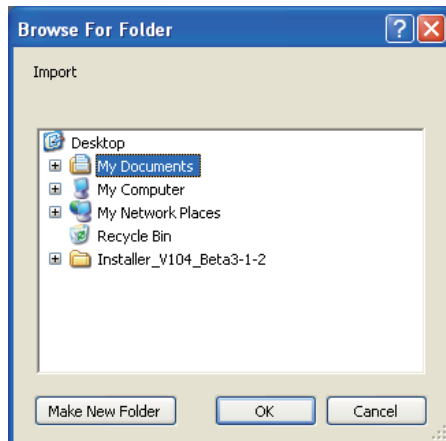

- 2 Select the folder that contains the backup file, and then click the **OK** Button.
The current project is closed and the data in the backup file is imported into a new project.

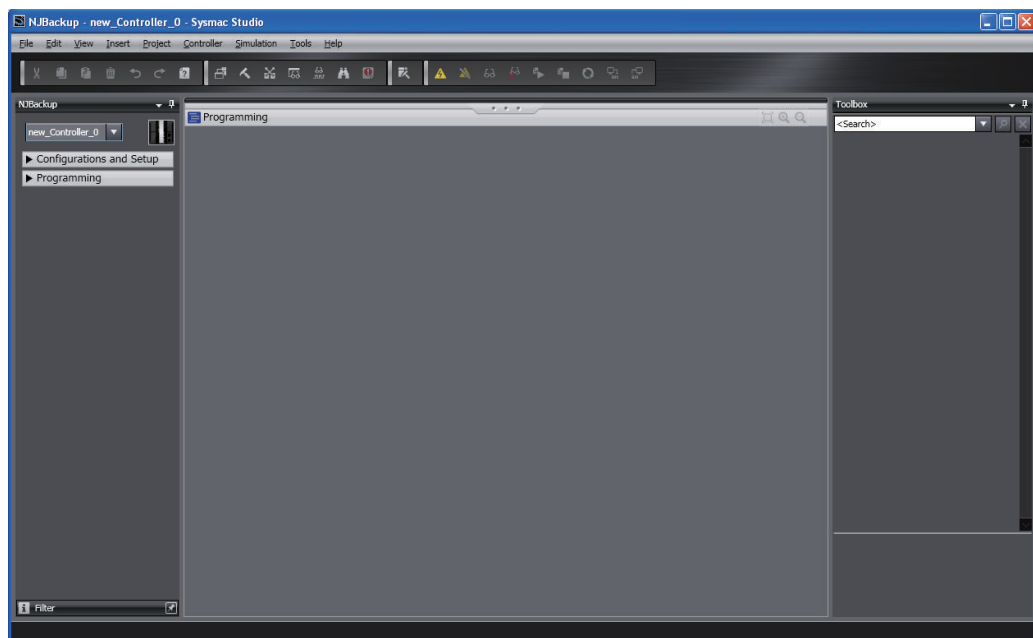

Exporting Backup Files

- 1 Open the project from which to export the backup file and select **Backup – Export Backup File** from the **Tools** Menu.
The Browse for Folder Dialog Box is displayed.

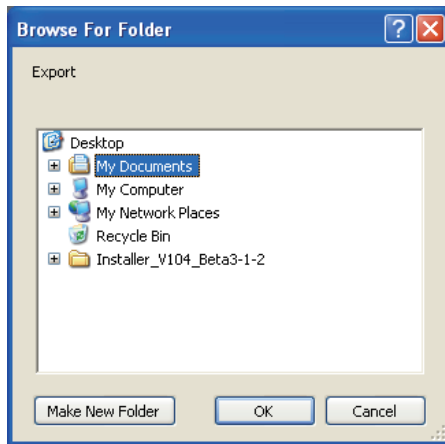

- 2 Select the folder in which to save the file and click the **OK** Button.
The Export Setting Dialog Box is displayed.

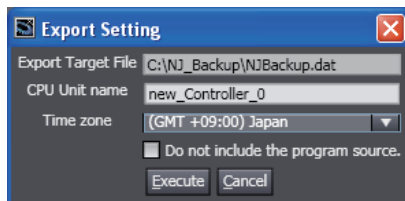

Option	Default	Description
CPU Unit name	CPU Unit name in the project	This option sets the name of the Controller. If you do not want to change the name of the Controller when you restore the data, set the name of the Controller here in advance.
Time zone*1	Japan	This option sets the time zone for the clock in the Controller. If you do not want to change the time zone of the Controller when you restore the data, set the time zone of the Controller here in advance.
Do not include the program source.	Not selected.	If you select this check box, the programs will not be saved. However, variables and settings are saved even if this check box is selected. The following operation is performed for a backup file that is created when this option is selected. <ul style="list-style-type: none"> • If the backup file is used to restore data to a Controller with the Controller backup or SD Memory Card backup function, the condition of the Controller will be the same as when data is transferred for synchronization with the <i>Do not transfer the program source</i> Check Box selected. • If the backup file is imported to a new project, the program will be empty, and a program error will occur.

*1. This is not displayed when the selected backup file is for an NY-series Controller.

- 3 Set the options and then click the **Execute** Button.
The backup file is created.



Precautions for Correct Use

Always confirm that the required data is included before you use a backup file that was exported from a project to restore data to a Controller.

8-11 Transferring All Controller Data

You can transfer the project data on the computer to the Controller or the data on the Controller to the project on the computer without using the synchronization operation.

This allows you to transfer the data with a shorter procedure than with the synchronization operation.

You can use it to reduce the amount of work required to transfer project data to more than one Controller after operation has been confirmed.

8-11-1 Transferring Data from the Computer to a Controller

- 1 Place the target Controller online and select **Controller – Transfer – To Controller** from the menu. Or, click the  Button in the toolbar.

The **Transfer to Controller** Dialog Box is displayed.

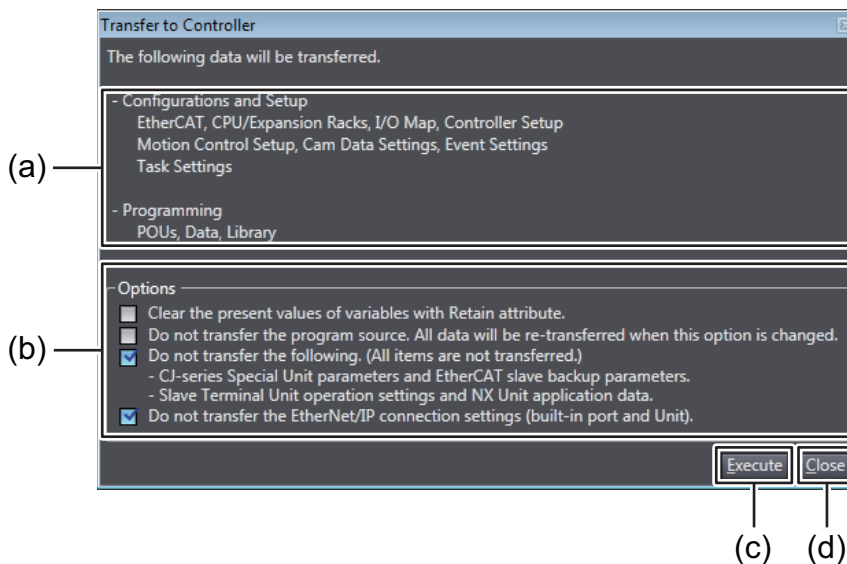

	Item	Description
(a)	Target data	Displays the data to transfer.
(b)	Options	Select the transfer options. The options are the same as for the synchronization operation. Refer to <i>Uploading and Downloading Data</i> on page 7-132 for details.
(c)	Execute Button	Starts transferring data to the Controller.
(d)	Close Button	Closes the Transfer to Controller Dialog Box.

- 2 Click the **Execute** Button.
The data is transferred to the Controller. The dialog box closes when the transfer is completed.

8-11-2 Transferring Data from the Controller to the Computer

- 1 Place the target Controller online and select **Controller – Transfer – From Controller** from the menu. Or, click the  Button in the toolbar.
The **Transfer from Controller** Dialog Box is displayed.

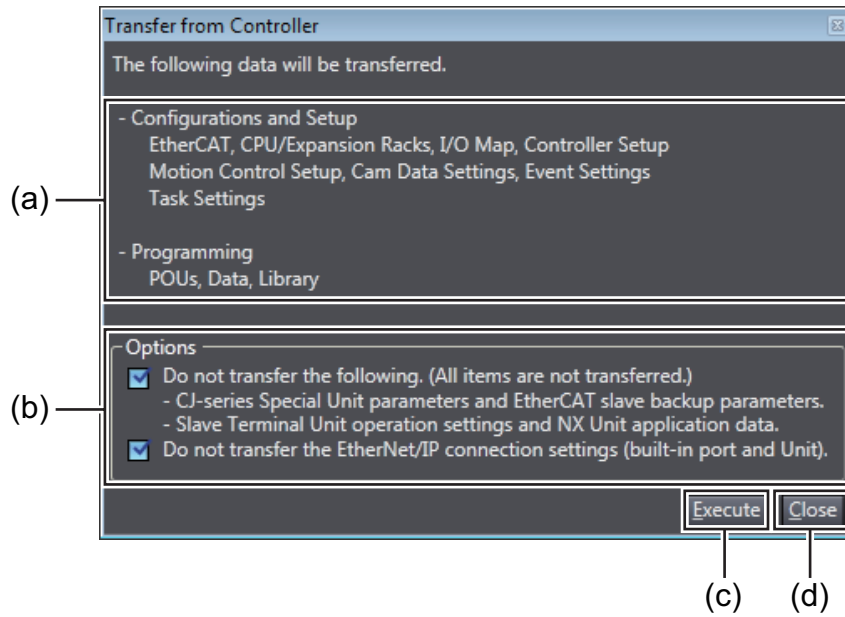

	Item	Description
(a)	Target data	Displays the data to transfer.
(b)	Options	Select the transfer options. The options are the same as for the synchronization operation. Refer to <i>Uploading and Downloading Data</i> on page 7-132 for details.
(c)	Execute Button	Starts transferring data to the computer.
(d)	Close Button	Closes the Transfer from Controller Dialog Box.

2 Click the **Execute** Button.

The data is transferred to the computer. The dialog box closes when the transfer is completed.

8-12 NX Unit Maintenance

The following describes the maintenance of NX Units that you can perform with the Sysmac Studio.

Calibrating NX Units

You can correct the characteristics of NX Analog I/O Units that will change over the years.

- 1** Go online, right-click an Analog Input Unit or Analog Output Unit in the CPU and Expansion Racks Tab Page or Slave Terminal Tab Page, and select **User Calibration** from the menu. The User Calibration dialog box is displayed.
- 2** Set the channel and calibration values and click the **Write** Button. A confirmation dialog box is displayed. Click the **Yes** Button to write the calibration values. Refer to the user's manual for the specific Analog Input Unit or Analog Output Unit for details on the setting values and operation of user calibration.

8-13 EtherCAT Maintenance

● EtherCAT Maintenance

The following operations are used for EtherCAT maintenance.

- Disconnecting a slave from and reconnecting a slave to the network
- Packet monitoring
- Diagnostic and statistical information
- Maintenance operations for EtherCAT Slave Terminals

8-13-1 Disconnecting a Slave from and Reconnecting a Slave to the Network

● Disconnecting a Slave from and Reconnecting a Slave to the Network

You can use this operation to disconnect a slave with active process data communications from the network without Process Data Communications Error occurring.

You can then reconnect the slave to the network to start process data communications again.

● Procedure for Disconnecting a Slave from the Network

Use the following procedure to disconnect a slave from the network.

- 1 Right-click the slave in the EtherCAT Tab Page and select **Disconnect/Connect Slave**.

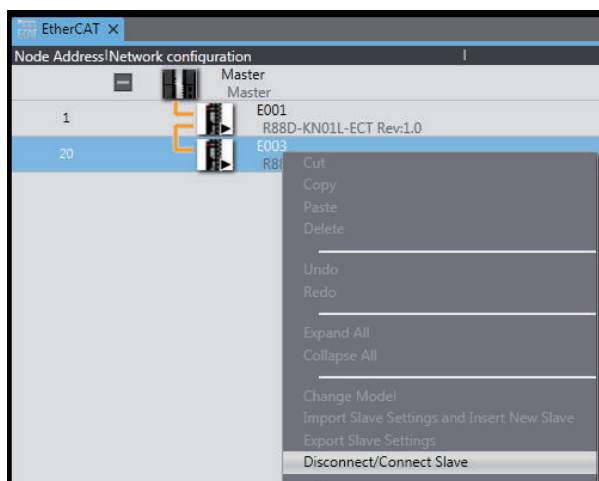

The Disconnect/Connect Slaves Dialog Box is displayed.

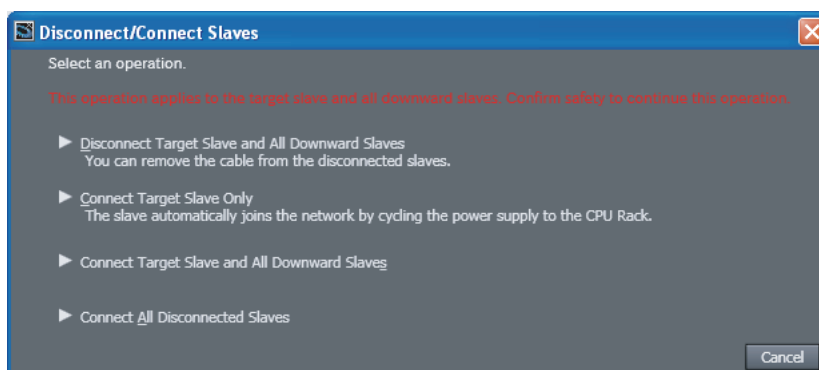

- 2** Click the **Disconnect Target Slave and All Downward Slaves** Button.
The selected slave and following slaves are disconnected.
The following confirmation dialog box is displayed if disconnection failed.

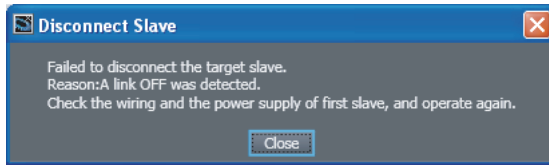

Additional Information

If you select a slave that has more than one output port and click the **Disconnect Target Slave and All Downward Slaves** Button, all of the slaves that are connected after all of the output ports will be disconnected.
You can remove the communications cables from the disconnected slaves.



Precautions for Correct Use

Disconnecting a slave affects not only the selected slave but all of the slaves connected after the output ports on the selected slave. When you disconnect slaves, all I/O refreshing for process data communications for the slaves is stopped. Always confirm safety before you disconnect a slave.

● Procedure for Reconnecting a Slave to the Network

- 1** Right-click the slave in the EtherCAT Tab Page and select **Disconnect/Connect Slave**.

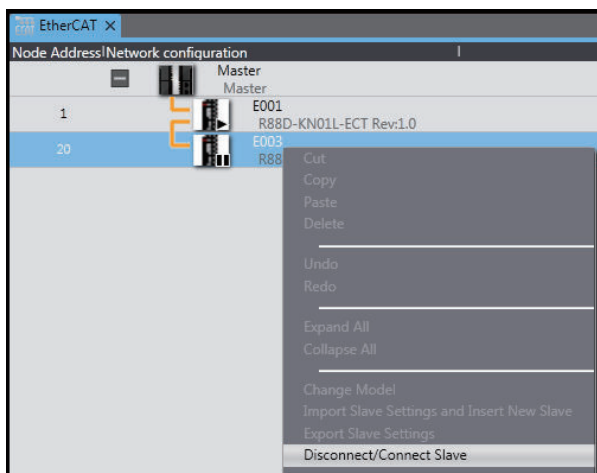

The Disconnect/Connect Slaves Dialog Box is displayed.

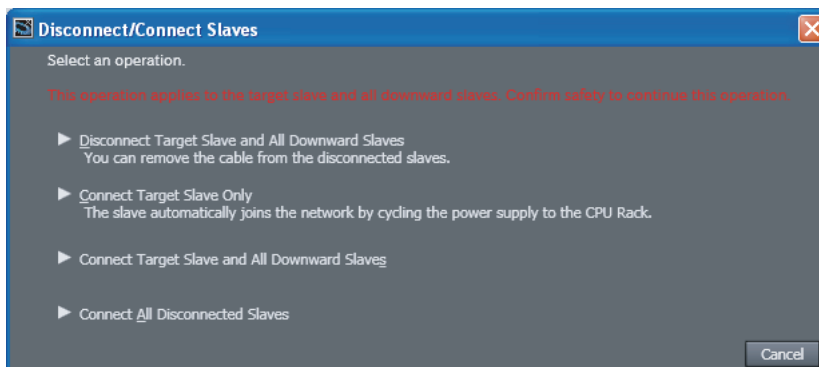

- 2** Click the **Connect Target Slave Only** Button.
The following dialog box is displayed and the selected slave is reconnected to the network. I/O refreshing with process data communications is restarted.





Note 1. Select the **Connect All Disconnected Slaves** Button to reconnect all slaves that are currently disconnected and to restart I/O refreshing through process data communications.

Note 2. Select **Connect target slave and the downward slaves** to reconnect the specified slave and all slaves that are connected after its OUT port. I/O refreshing with process data communications is restarted.



Additional Information

When the EtherCAT configurations are synchronized, the status of the slaves are displayed in the EtherCAT Tab Page with the following icons. These icons are not displayed if synchronization is lost.

Icon	Meaning
	The slave exists on the actual network.
	The slave exists on the actual network but it is disconnected.
	The slave is not connected and does not exist (i.e., is not connected) in the actual network. (This icon could also indicate a slave that was connected in the location of a disconnected slave without the node address set.)
	The slave does not exist on the actual network.
	Communications are disabled for the slave.

8-13-2 Packet Monitoring



Version Information

Packet monitoring can be used for a CPU Unit with unit version earlier than 1.40.

● Packet Monitoring

The master can monitor the packets that are transmitted through the network. From the Sysmac Studio, you can start and stop packet monitoring by the master, and you can get part of the packet data monitored by the master and save it in a file.

● Procedure

- 1** Right-click the master in the EtherCAT Tab Page and select **Display Packet Monitor**. The Packet Monitor Dialog Box is displayed.

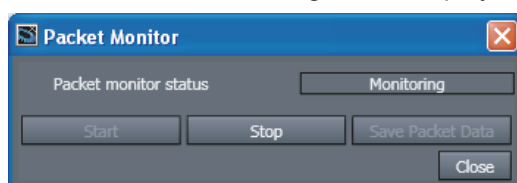

- 2** Click the **Start** Button to begin monitoring.

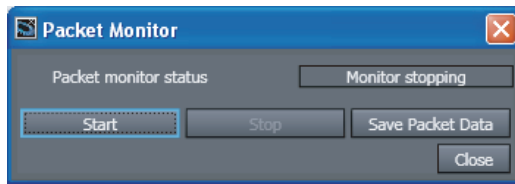

- 3 Click the **Stop** Button to stop monitoring.

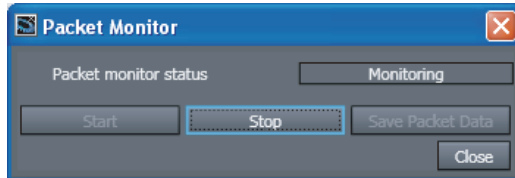

- 4 Click the **Save Packet Data** Button to save the results of the monitoring.
The **Save File** Dialog Box is displayed.
- 5 Input a file name, and then click the **Save** Button.
A TCPDump packet data file with a .cap extension is saved.

8-13-3 Diagnostic and Statistical Information

● Diagnostic and Statistical Information

Diagnostic and statistical information provides statistics on diagnosis of EtherCAT communications status, such as the number of frames that are sent and received. The Diagnosis/Statistics Information Tab Page displays information on the EtherCAT master and slaves. This section gives the procedure to display and operate the *Diagnosis/Statistics Information Tab Page*, which is displayed online, and the procedure for displaying and operating the *EtherCAT Diagnosis/Statistics Information Viewer* that displays the data saved in the *Diagnosis/Statistics Information Tab Page* in offline state. Refer to the *NJ/NX-series CPU Unit Built-in EtherCAT Port User's Manual (Cat. No. W505)* or *NY-series Industrial Panel PC / Industrial Box PC Built-in EtherCAT Port User's Manual (Cat. No. W562)* for details on the displayed information and troubleshooting methods for diagnostic and statistical information.

Diagnosis/Statistics Information Tab Page

● Diagnosis/Statistics Information Tab Page Operating Procedure

- 1 Right-click the master in the EtherCAT Tab Page and select **Display Diagnosis/Statistics Information**.
The **Diagnosis/Statistics Information** Tab Page is displayed.

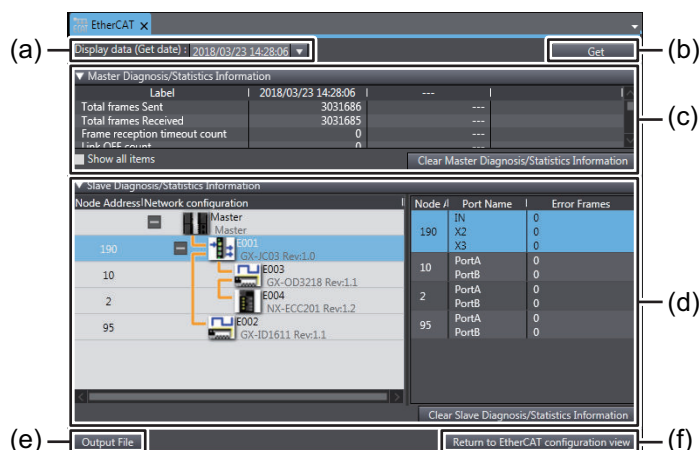

	Item	Description
(a)	Display data (Get date) list	Displays the list of dates and times at which you acquired the diagnostic and statistical information by clicking the Get Button. If you select a date and time from the list, the display of the diagnostic and statistical information for both master and slave are changed to the data for the selected date and time.
(b)	Get Button	Acquires the master and slave diagnostic and statistical information from the actual network configuration. The date and time of information acquisition is added to the Display data (Get date) list . You can retain a maximum of 100 diagnostic and statistical information data items acquired while the Diagnosis/Statistics Information Tab Page is displayed.
(c)	Master Diagnosis/Statistics Information	Displays the master diagnostic and statistical information.
(d)	Slave Diagnosis/Statistics Information	Displays the slave diagnostic and statistical information.
(e)	Output File Button	Saves the diagnostic and statistical information, and values of system-defined variables*1 of the master and slaves at all acquisition dates and times retained in the Diagnosis/Statistics Information Tab Page into a Viewer format file or CSV format file. The CSV file is encoded in UTF-8 character codes.
(f)	Return to EtherCAT configuration view Button	Closes the Diagnosis/Statistics Information Tab Page and returns the display to the EtherCAT Tab Page.

*1. The following system-defined variables of the slaves whose `_EC_RegSlavTbl` variable is set to TRUE are saved.
`_EC_EntrySlavTbl`, `_EC_MBXSlavTbl`, and `_EC_PDSlavTbl`

- 2** Click the **Get** Button when you want to acquire diagnostic and statistical information. The display of the master and slave diagnostic and statistical information is updated and the date and time of acquisition is added to the **Display data (Get date) list**. To display the master and slave diagnostic and statistical information that was already acquired, select the date and time of acquisition from the **Display data (Get date) list**.
- 3** To save the master and slave diagnostic and statistical information, click the **Output File** Button. The file format selection dialog box is displayed.

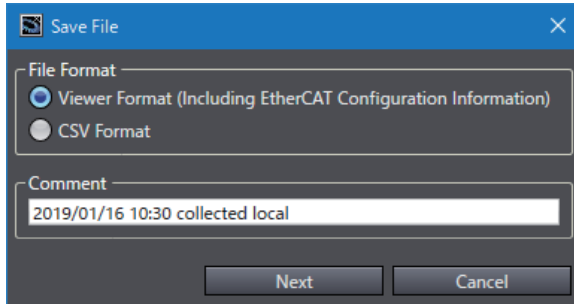

File format	Description
Viewer Format (Including EtherCAT Configuration Information)	Select this format to read and display data offline with the <i>EtherCAT Diagnosis/Statistics Information Viewer</i> .
CSV Format	Select this format to display data with spreadsheet software such as Excel.

4 Select the file format for saving data, enter any comment, and click the **Next** Button. The **Save File** Dialog Box is displayed.

5 Enter a file name, and then click the **Save** Button. When Viewer Format is selected, a file with a .xml extension is saved. When CSV Format is selected, a file with a .csv extension (comma-separated) is saved.



Precautions for Correct Use

- The data of diagnostic and statistical information acquired with the **Get** Button are retained only while the **Diagnosis/Statistics Information** Tab Page is displayed. When the **Diagnosis/Statistics Information** Tab Page is closed, all data are discarded. Save the diagnostic and statistical information into a file as needed before you close the **Diagnosis/Statistics Information** Tab Page.
- The maximum number of diagnostic and statistical information data items you can retain while the **Diagnosis/Statistics Information** Tab Page is displayed is 100. To acquire more data after the maximum number of retained data items is reached, close the **Diagnosis/Statistics Information** Tab Page to discard the retained data, and then open the tab page again to acquire new data.
- You cannot acquire the slave diagnostic and statistical information when the diagnosis/statistics log of the Controller is in progress. To acquire the slave diagnostic and statistical information, finish the diagnosis/statistics log, and then click the **Get** Button again. When the diagnosis/statistics log of the Controller is in progress, *Auto logging* is displayed in the **Error Frames** Column in the slave diagnostic and statistical information table. Refer to the *NJ/NX-series CPU Unit Built-in EtherCAT Port User's Manual (Cat. No. W505)* or *NY-series Industrial Panel PC / Industrial Box PC Built-in EtherCAT Port User's Manual (Cat. No. W562)* for details on the diagnosis/statistics log.

● Master Diagnostic and Statistical Information

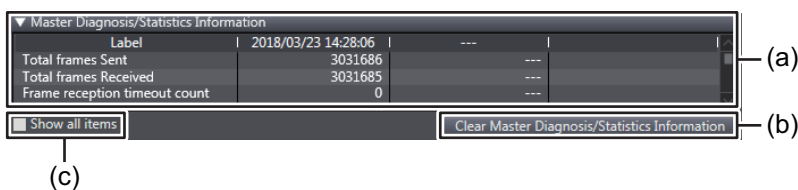

	Item	Description
(a)	Master Diagnostic and Statistical Information list	Displays the master diagnostic and statistical information.
(b)	Clear Master Diagnosis/Statistics Information Button	Clears the diagnostic and statistical information saved in the master.
(c)	Show all items Check Box	Select this check box to display all items of the master diagnostic and statistics information.

If the master diagnostic and statistical information is cleared, the display of the master diagnostic and statistical information in the **Diagnosis/Statistics Information** Tab Page is cleared to zeros. Also, the slave diagnostic and statistical information is acquired automatically and the display of the **Diagnosis/Statistics Information** Tab Page is updated.

● Slave Diagnosis and Statistics Information

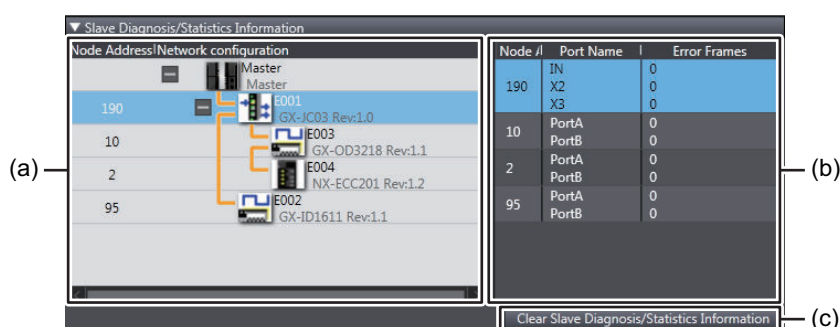

	Item	Description
(a)	EtherCAT Configuration display	The EtherCAT Configuration of the project is displayed. An error icon that indicates the occurrence of an error is displayed for the master or the slave where an error occurred. Place the mouse over the error icon, and the current event is displayed in a tooltip.
(b)	Slave Diagnostic and Statistical Information list	Displays the slave diagnostic and statistical information.
(c)	Clear Slave Diagnosis/Statistics Information Button*1	Clears the diagnostic and statistical information saved in the slave.

*1. This appears only when the unit version of the CPU Unit set in the Sysmac Studio project is 1.11 or later.

If the slave diagnostic and statistical information is cleared, the display of the slave diagnostic and statistical information in the **Diagnosis/Statistics Information** Tab Page is cleared to zeros. Also, the master diagnostic and statistical information is acquired automatically and the display of the **Diagnosis/Statistics Information** Tab Page is updated.



Precautions for Correct Use

- When the maximum number of acquired diagnostic and statistical information is reached, you need to discard the acquired data to clear the diagnostic and statistical information. If you need to save the data, output the file before you execute the clear command.
- You cannot clear the slave diagnostic and statistical information when the diagnosis/statistics log of the Controller is in progress. Finish the diagnosis/statistics log, and then execute the clear operation for the slave diagnostic and statistical information again. When the diagnosis/statistics log of the Controller is in progress, *Auto logging* is displayed in the **Error Frames** Column in the slave diagnostic and statistical information table.
- When you display the slave diagnostic and statistical information, make sure that the actual EtherCAT network configuration agrees with the network configuration in the project. If the network configurations do not agree, the slave diagnostic and statistical information display will not be correct. If you execute the clear command for the slave diagnostic and statistical information when the network configurations do not agree, the information may not be cleared properly.

EtherCAT Diagnosis/Statistics Information Viewer

In the EtherCAT Diagnosis/Statistics Information Viewer, you can display diagnostic and statistical information saved in a file in offline state.

Diagnostic and statistical information data must be saved into a *Viewer Format* file in advance in the Diagnosis/Statistics Information Tab Page. Refer to *Diagnosis/Statistics Information Tab Page Operating Procedure* on page 8-94 for the procedure to save data into a file.

● EtherCAT Diagnosis/Statistics Information Viewer Operating Procedure

- 1 Select **Tools - EtherCAT Diagnosis/Statistics Information Viewer** from the main menu. The diagnostic and statistical information file selection dialog box is displayed.
- 2 Select the target diagnostic and statistical information file, and then click the **Open** Button. The **EtherCAT Diagnosis/Statistics Information Viewer** Dialog Box starts, and the selected diagnostic and statistical information is displayed.

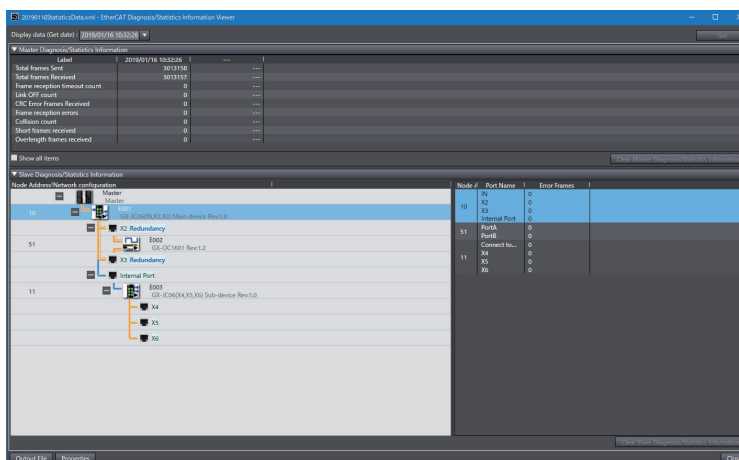

The displayed contents are the same as those displayed in the Diagnosis/Statistics Information Tab Page.



Additional Information

- Data can be saved into a file from the **EtherCAT Diagnosis/Statistics Information Viewer** Dialog Box in CSV format only.
- The following buttons are grayed out.
Get, Clear Master Diagnosis/Statistics Information, and Clear Slave Diagnosis/Statistics Information

● Displaying Diagnostic and Statistical Information File Properties

In the **EtherCAT Diagnosis/Statistics Information Viewer** Dialog Box, you can display the properties of the currently displayed diagnostic and statistical information.

- 1 Click the **Properties** Button in the **EtherCAT Diagnosis/Statistics Information Viewer** Dialog Box.

The **Properties** Dialog Box is displayed.

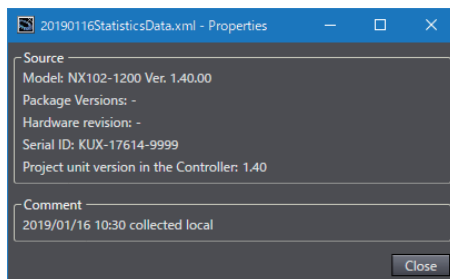

The controller information and comments when the diagnostic and statistical information was obtained are displayed in the **Properties** Dialog Box.

8-13-4 Maintenance Operations for EtherCAT Slave Terminals

The following maintenance operations are supported for EtherCAT Slave Terminals.

- Restarting Units in a Slave Terminal
- NX Unit Calibration
- I/O Wiring Checks

● Restarting Units in a Slave Terminal

Use the following procedure to restart the Units in a Slave Terminal. You can restart all of the Units in the Slave Terminal or you can restart individual Units.

- 1 To restart all of the Units in the Slave Terminal, go online, right-click the Communications Coupler Unit on the Slave Terminal Tab Page, and select **Restart**. To restart individual Units in the Slave Terminal, go online, right-click the Unit to restart on the Slave Terminal Tab Page, and select **Restart**.

The Restart Confirmation Dialog Box is displayed.

Example: When Restarting All of the Units in a Slave Terminal

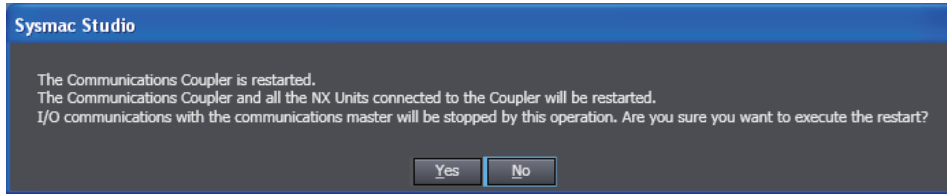

- 2** Click the **Yes** Button.
The restart is completed.



Additional Information

A Communications Coupler Unit with unit version 1.2 or later is required to restart individual Units.

● NX Unit Calibration

Calibration can be performed to compensate for temporal changes in the characteristics of Analog I/O Units.

Go online, right-click an Analog Input Unit or Analog Output Unit and select **User Calibration**. Refer to *8-12 NX Unit Maintenance* on page 8-90 for details.

● I/O Wiring Checks

Refer to *7-5-3 Checking I/O Wiring* on page 7-153 for details on wiring checks for NX Units on a Slave Terminal.

To perform I/O wiring checks for Slave Terminals that are not connected to the Controller, connect the Sysmac Studio directly to the Slave Terminal. Refer to *A-8 Directly Connecting to an EtherCAT Slave Terminal* on page A-59 for details.

8-14 Grouping for POU's and Global Variables

This function allows you to group multiple POU's and global variables.

With this function, you can group them by several aspects such as process or functionality, and clearly organize the programming constitutions.

This function does not affect the operation of programs.

8-14-1 Displaying the Programming Group Tab Page

- 1 Select **Programming Group Tab Page** from **View** in the Main Menu.

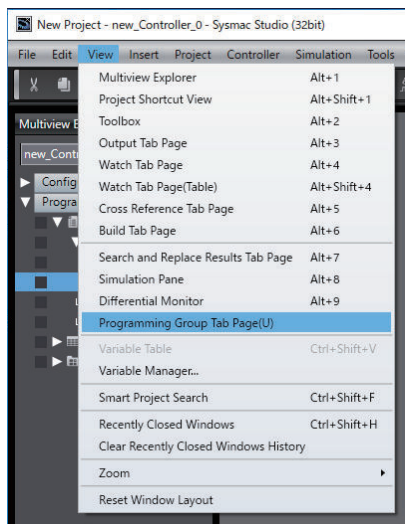

The **Programming Group tab page** is displayed.



It is displayed below the Filter Pane by default.



Additional Information

After you perform any of the following operations, click the **Update** Button on the Programming Group tab page to update the display.

- Adding a new group in the global variable table
- Switching a device
- Deleting a POU that is registered in a group

The Programming Group tab page can be used only in a standard project.

8-14-2 Grouping POUs

Multiple POUs can be grouped for display.

Grouping POUs is performed on the Programming Group tab page.

Creating a New Group and Adding POUs

- 1 Right-click in the **Programming Group** tab page and select **New group and add POUs**.

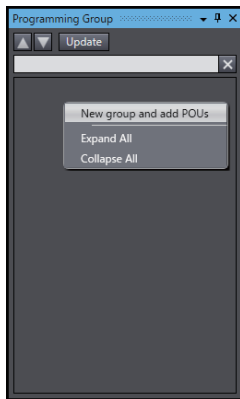

The **Enter new group name** dialog box is displayed.

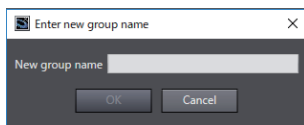

- 2 Enter a group name, and then click the **OK** Button.

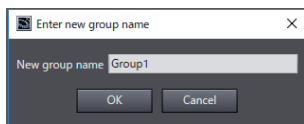

The **Add POUs to the group** dialog box is displayed.

- 3 Select the POUs you want to group, and then click the **OK** Button.

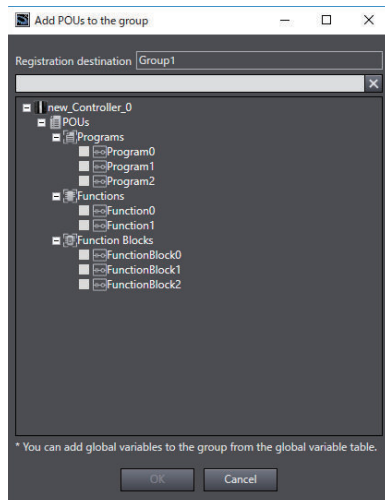

Grouped POUs are displayed in the **Programming Group** tab page.

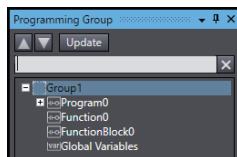

The **global variables** are displayed below the created group at the same time.

Any global variables can be added to the group.

Refer to *8-14-3 Grouping Global Variables* on page 8-105 for how to add global variables to a group.

Adding New POUs to Existing Group

- 1 Right-click an existing group where you want to add POUs, and then select **Add POUs to the group**.

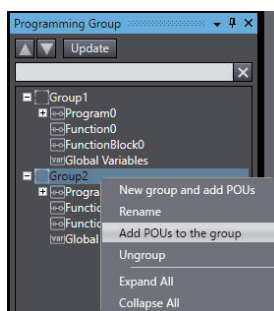

The **Add POUs to the group** dialog box is displayed.

- 2 Select the POUs to add, and then click the **OK** Button.
The specified POUs are added in the group.

Changing Group Name

- 1 Right-click an existing group to rename and select **Rename** from the menu.

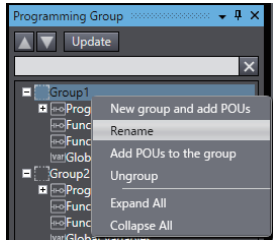

The **Enter new group name** dialog box is displayed.

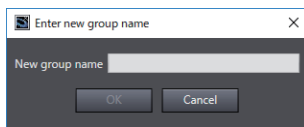

- 2 Enter a group name, and then click the **OK** Button.

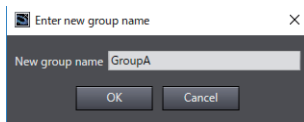

The present group name is changed.

Ungrouping

- 1 Right-click an existing group to ungroup and select **Ungroup** from the menu.

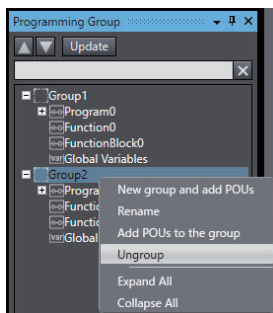

A confirmation dialog box for ungrouping is displayed.

- 2 Click the **OK** Button.

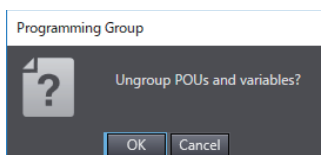

The specified group is deleted from the **Programming Group** tab page.

Removing a POU from a Group

- 1 Right-click the POU to remove from the group and select **Remove from the group** from the menu.

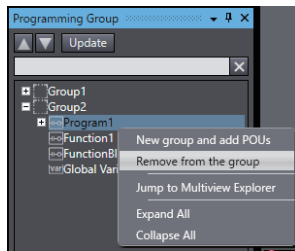

A confirmation dialog box for removing is displayed.

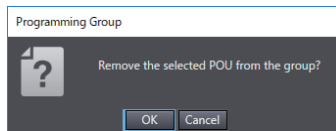

- 2 Click the **OK** Button.
The specified POU is removed from the group.

8-14-3 Grouping Global Variables

Grouping of the global variables is performed in the global variable table.

Creating a New Group and Adding Global Variables

- 1 Double-click **Global Variables** in the Multiview Explorer.

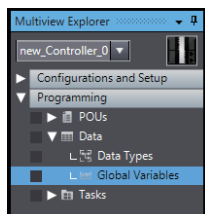

The global variable table is displayed.

- 2 Right-click the header on the row of the global variable to select **Add to new group** under **Group Settings**.

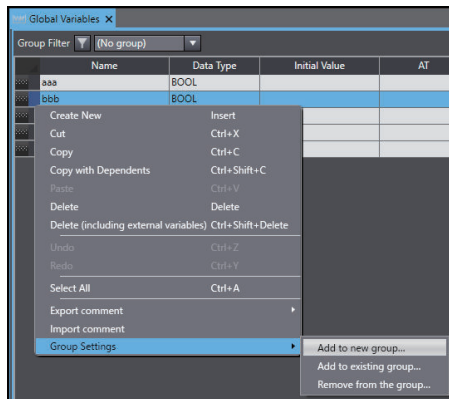

The **Enter new group name** dialog box is displayed.

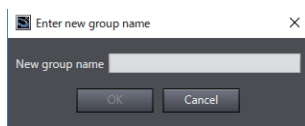

- 3** Enter a group name, and then click the **OK** Button.

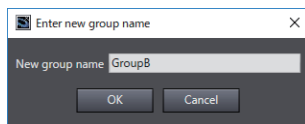

The message is displayed to notify that creation of the group and addition of the variables have been completed.

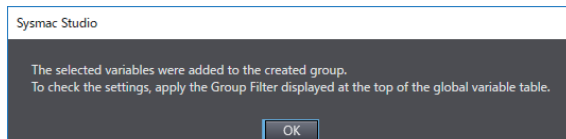

- 4** Click the **OK** Button.

The global variable you selected is added to the created group.

Refer to *Checking the Global Variable Added to a Group* on page 8-107 to confirm the global variables added to the group.



Additional Information

After you create a new group, click the **Update** Button on the Programming Group tab page to display the created group on the tab page.

Adding a New Global Variable to an Existing Group

- 1** Right-click the header on the row of a global variable you want to add, and then select **Add to existing group** under **Group Settings**.

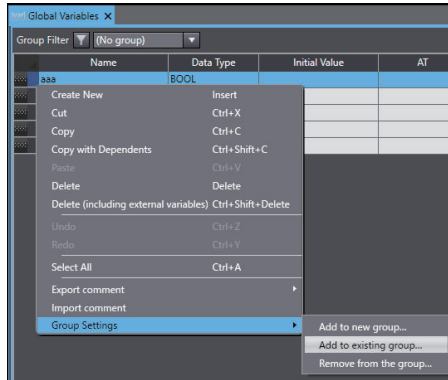

The **Select group** dialog box is displayed.

- 2 Select a destination group, and then click the **OK** Button.

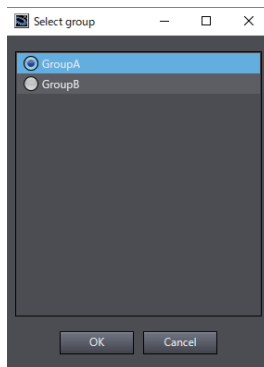

The global variable is added to the selected group.

Checking the Global Variable Added to a Group

To check the global variable added to the group, apply the group filter in the global variable table.

- 1 Select a group name and then click the **Group Filter** Button.

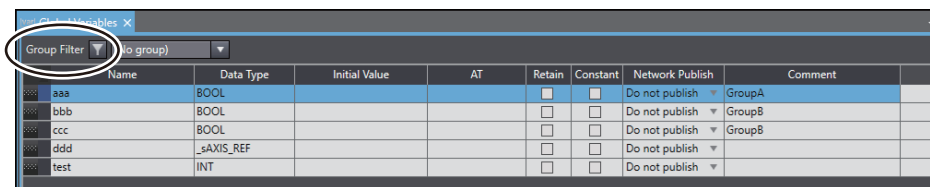

Only the global variables in the selected group are displayed.

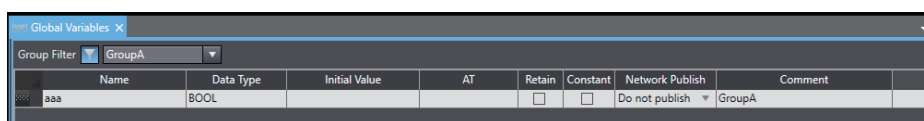

Click again the **Group Filter** Button to clear the group filter.

Once you clear the group filter, all global variables are displayed.

Removing a Global Variable from a Group

- 1 Right-click the header on the row of the global variable to remove, and then select **Remove from the group** under **Group Settings**.

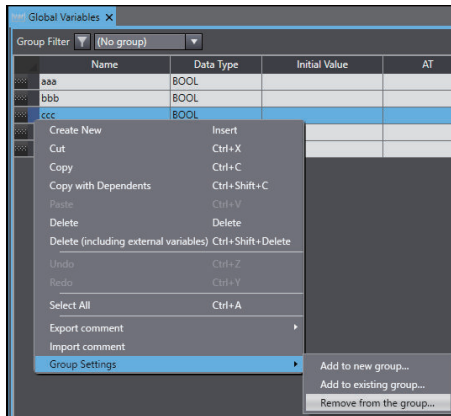

A confirmation dialog box for removing global variables from the group is displayed.

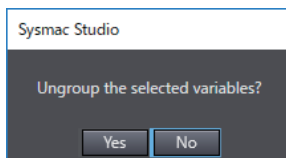

- 2 Click the **Yes** Button.
The selected global variable is removed from the group.

8-15 Project Shortcut View

This function enables you to create shortcuts for the Configurations and Setup items and Programming items in the Multiview Explorer.

By registering shortcuts, you can easily access the Configurations and Setup items and Programming items in the Multiview Explorer.

You can also create folders to organize the created shortcuts.

This function does not affect the operation of programs.



Precautions for Correct Use

This function is supported only by the Sysmac Studio (64 bit).

The created folders or registered shortcuts are not transferred to the Controller.

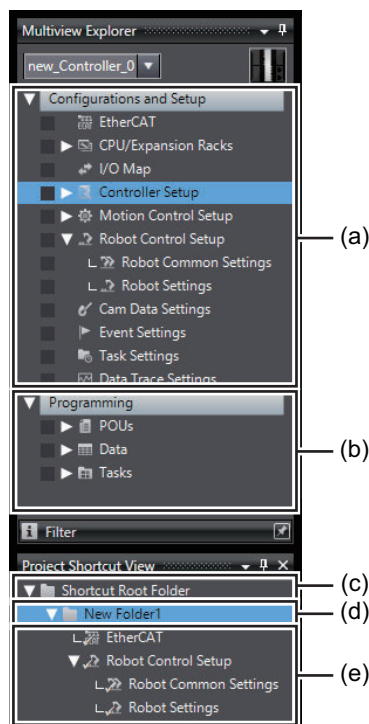

	Series
(a)	Configurations and Setup items
(b)	Programming items
(c)	Shortcut Root Folder
(d)	User folder
(e)	Shortcuts for Configurations and Setup items or Programming items

8-15-1 Displaying the Project Shortcut View

- 1 Select **Project Shortcut View** from the **View** Menu.

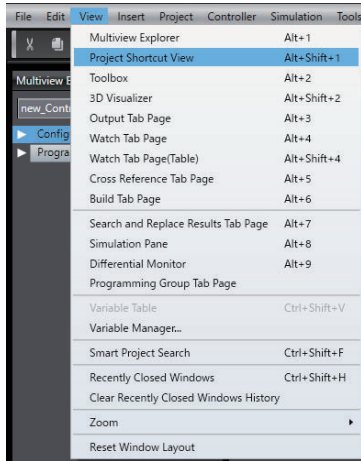

The **Project Shortcut View** is displayed in the Filter Pane.

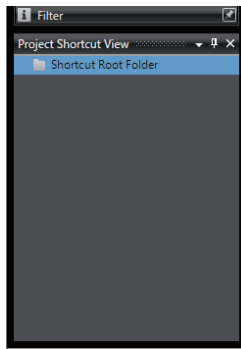

The **Shortcut Root Folder** is created in the **Project Shortcut View**.

You cannot delete the **Shortcut Root Folder**.

By default, only the **Shortcut Root Folder** is displayed.



Additional Information

- If the project contains any of the following devices, the **Project Shortcut View** is displayed in the default position. If the project contains none of the following devices, the **Project Shortcut View** is not displayed.
 - a) Robot Integrated CPU Unit
 - b) Application Manager
- When the Sysmac Studio has gone online with the Controller without a project open, **Project Shortcut View** is not displayed.

8-15-2 Adding User Folders

Right-click the Shortcut Root Folder and select **Add Folder**.

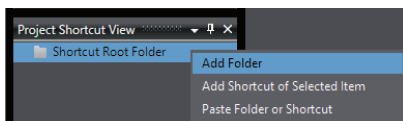

Under the Shortcut Root Folder, a new folder is created.

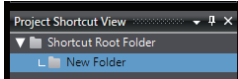

8-15-3 Renaming User Folders

- 1 Right-click the user folder to rename and select **Rename Folder** from the menu.

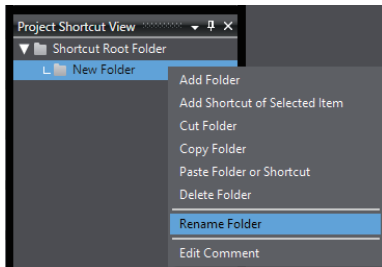

- 2 You can now rename the user folder in the Edit Pane.

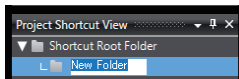

Enter any name.

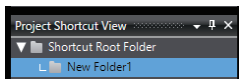

8-15-4 Copying and Pasting User Folders

- 1 Right-click the user folder to copy and select **Copy Folder** from the menu.

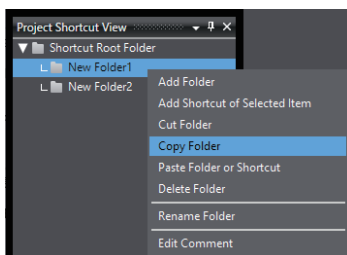

- 2 Right-click the copy destination folder and select **Paste Folder or Shortcut** from the menu.

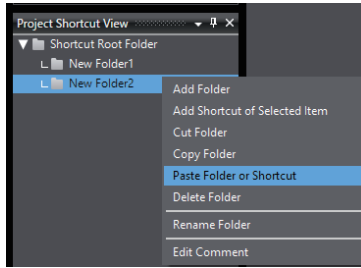

Under the Shortcut Root Folder, or the selected user folder, the copied folder is pasted.

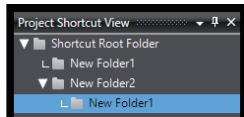

Additional Information

You can perform this operation on more than one selection.

8-15-5 Cutting User Folders

Right-click the user folder to delete or copy and select **Cut Folder** from the menu.

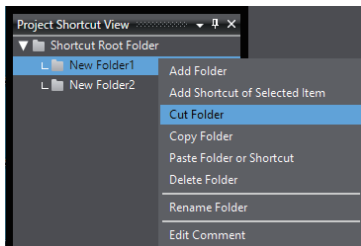

Refer to *8-15-4 Copying and Pasting User Folders* on page 8-111 for how to add a user folder by copying it.



Additional Information

You can perform this operation on more than one selection.

8-15-6 Deleting User Folders

- 1 Right-click the user folder to delete and select **Delete Folder** from the menu.

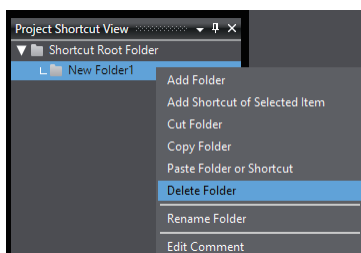

A deletion confirmation dialog box is displayed.

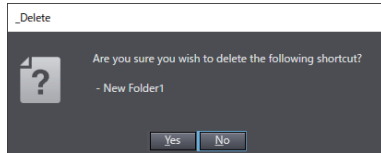

- 2 Click the **Yes** Button.
The user folder is deleted.



Additional Information

You can perform this operation on more than one selection.

8-15-7 Editing Comments on User Folders

You can enter a comment on a user folder to display it in a tooltip.

- 1 Right-click the user folder, Configurations and Setup item, or Programming item on which to enter a comment and select **Edit Comment**.
A dialog box is displayed for you to enter a comment.

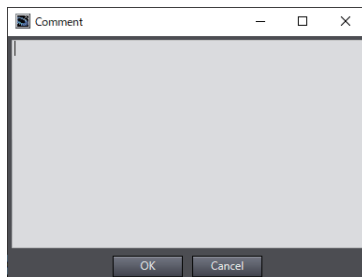

- 2 Enter a comment.
- 3 Click the **OK** Button.

8-15-8 Adding Shortcuts

You can add shortcuts from a Configurations and Setup item, Programming item, or user folder.

Adding Shortcuts from a Configurations and Setup Item or Programming Item

This function is available only when the Robot Integrated CPU Unit or Application Manager is selected.

- 1 Select the Configurations and Setup item or Programming item to jump to from a shortcut.
- 2 Right-click the user folder in which to add a shortcut and select **Add Shortcut of Selected Item** from the menu.

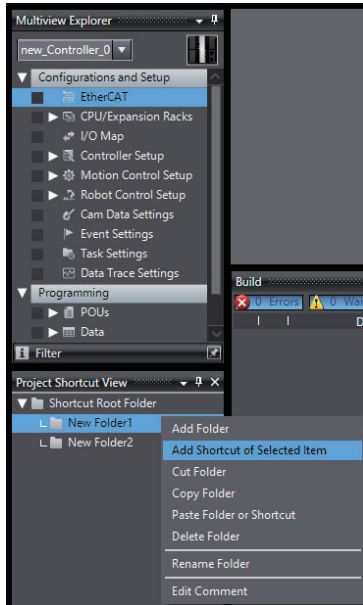

A shortcut is created under the user folder.

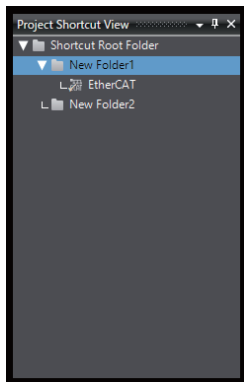

It is displayed with an icon for the created Configurations and Setup item or Programming item (🔌).

Adding Shortcuts from a User Folder

- 1 Select the user folder in which to add a shortcut.

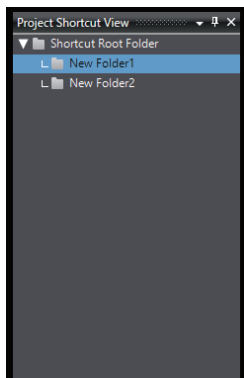

- 2 Right-click the Configurations and Setup item or Programming item for which to create a shortcut and select **Add Shortcut**.

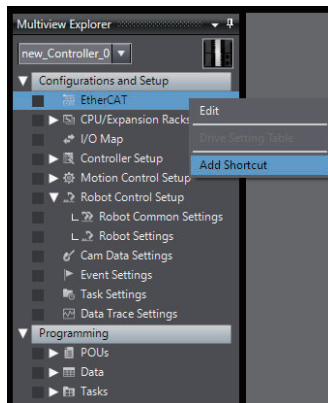

A shortcut is created under the user folder.

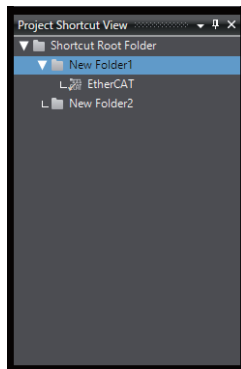

It is displayed with an icon for the created Configurations and Setup item or Programming item (📁).



Additional Information

- If the item selected in the Multiview Explorer has child items, a shortcut is created for items including the child items. Shortcuts for the items related to the Configurations and Setup item or Programming item are displayed under the selected folder.
- If there are items related to the item to add, in addition to its shortcut, you can add the shortcuts for the related items together.
- You can move shortcuts between folders by dragging them from one folder to another. However, you cannot move child shortcuts of a shortcut.

8-15-9 Editing Items from Shortcuts

Right-click the shortcut to an item to edit and select **Multiview Explorer Menu – Edit** from the menu.

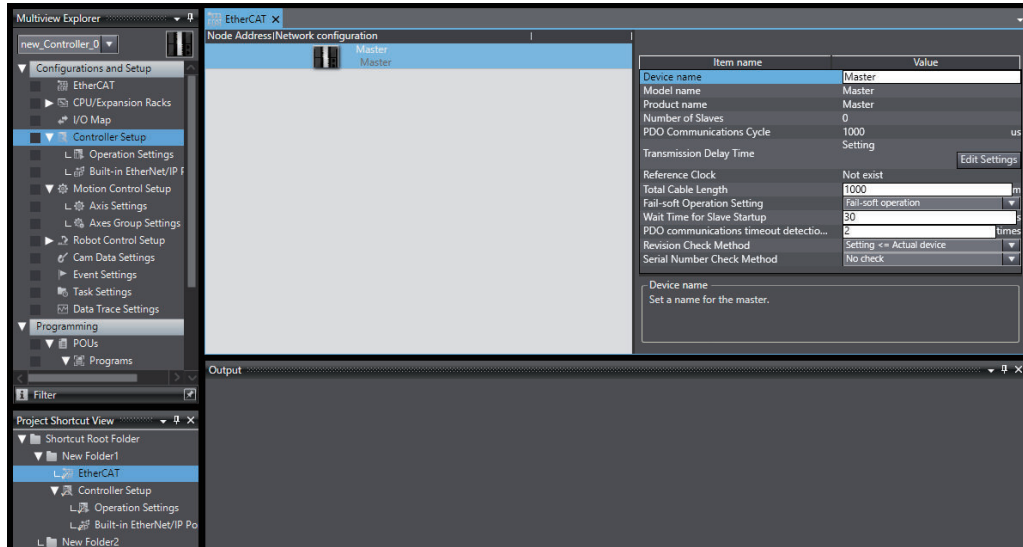

You can now edit it in the Edit Pane.

8-15-10 Copying and Pasting Shortcuts

- 1 Right-click the shortcut to copy and select **Copy Shortcut** from the menu.

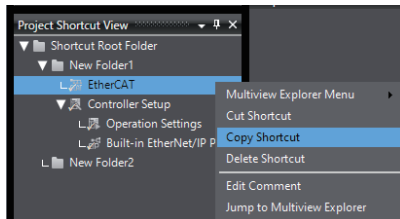

- 2 Right-click the copy destination folder and select **Paste Folder or Shortcut** from the menu.

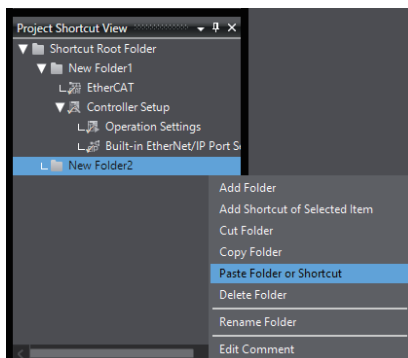

Under the Shortcut Root Folder, or the selected user folder, the copied shortcut is pasted.

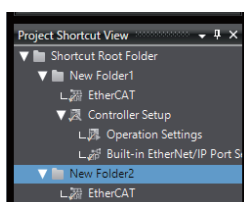



Additional Information

You can perform this operation on more than one selection.

8-15-11 Cutting Shortcuts

Right-click the user folder to delete or copy and select **Cut Shortcut** from the menu.

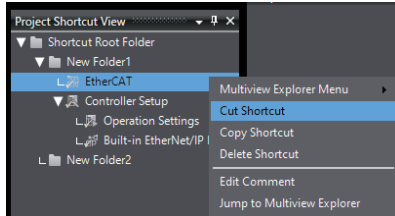

Refer to *8-15-11 Cutting Shortcuts* on page 8-117 for how to add a shortcut by copying it.



Additional Information

You can perform this operation on more than one selection.

8-15-12 Deleting Shortcuts

- 1 Right-click the shortcut to delete and select **Delete Shortcut** from the menu.

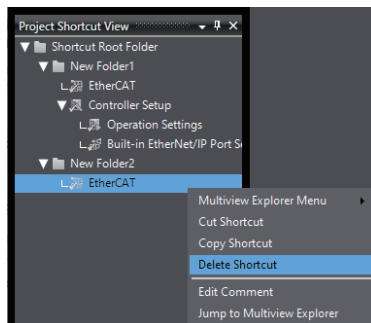

A deletion confirmation dialog box is displayed.

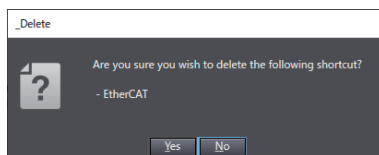

- 2 Click the **Yes** Button.
The shortcut is deleted from the folder.



Additional Information

You can perform this operation on more than one selection.

8-15-13 Editing Comments on Shortcuts

You enter a comment on a shortcut to display it in a tooltip.

- 1 Right-click the shortcut on which to enter a comment and select **Edit Comment** from the menu.

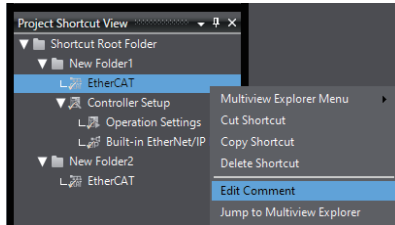

A dialog box is displayed for you to enter a comment.

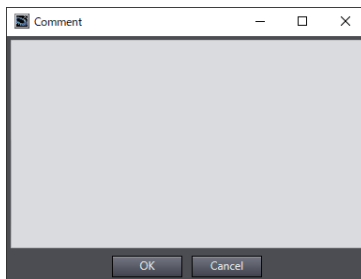

- 2 Enter a comment.
- 3 Click the **OK** Button.

8-15-14 Jumping from a Shortcut to the Multiview Explorer

You can jump from a selected shortcut to the associated item in the Multiview Explorer.

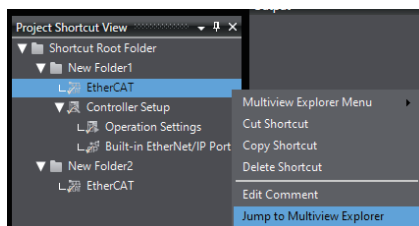

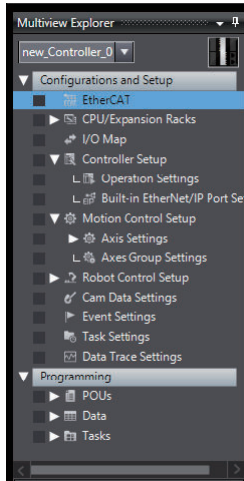

The focus moves to the Configurations and Setup item or Programming item for the selected shortcut.

8-16 Troubleshooting

● Overview of Troubleshooting

Troubleshooting is used to check the errors that occurred in the Controller, display corrections for the errors, and clear the errors.

8-16-1 Troubleshooting Dialog Box

The current errors in the online Controller and the contents of the event logs are read and displayed in the **Troubleshooting and Event Logs** Dialog Box.

- 1 Select **Troubleshooting** from the **Tools** Menu while online. You can also click the **Troubleshooting** Button in the toolbar.

The following **Troubleshooting** Dialog Box is displayed.

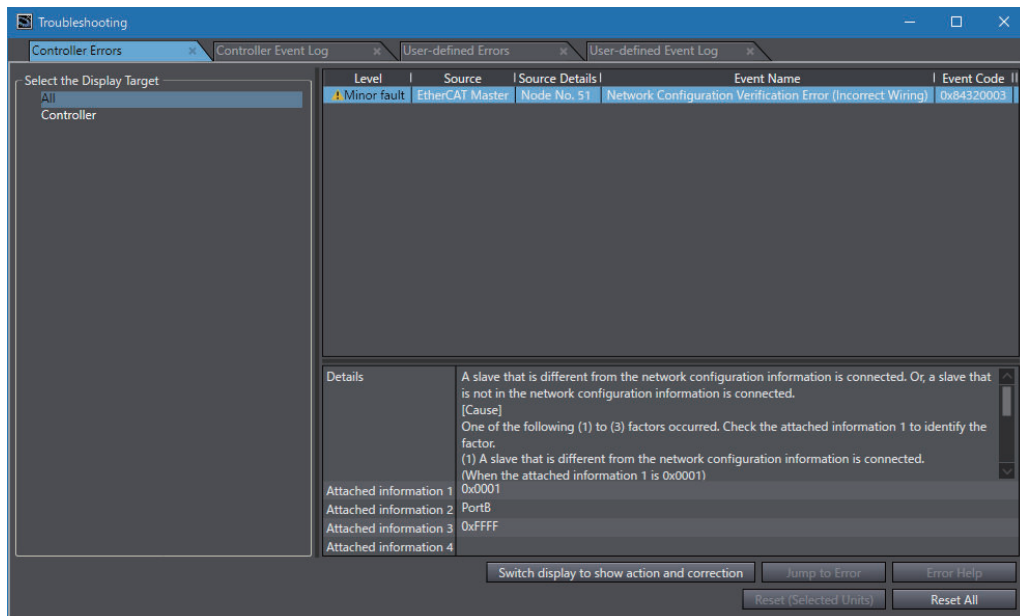

- 2 Click the following tabs to change the display as required.

Tab	Displayed information
Controller Errors	This tab page reports Controller errors as well as error details and corrections.
Controller Event Log	This tab page displays errors and information recorded in the event logs in the Controller.
User-defined Errors	This tab page reports user-defined errors and user-defined information that is created by execution of the SetAlarm (Create User-defined Error) instruction and the SetInfo (Create User-defined Information) instruction.
User-defined Event Log	This tab page displays user-defined errors and user-defined information recorded in the event log in the Controller.

8-16-2 Controller Errors

This tab page displays any current Controller errors. (Observations and information are not displayed.)

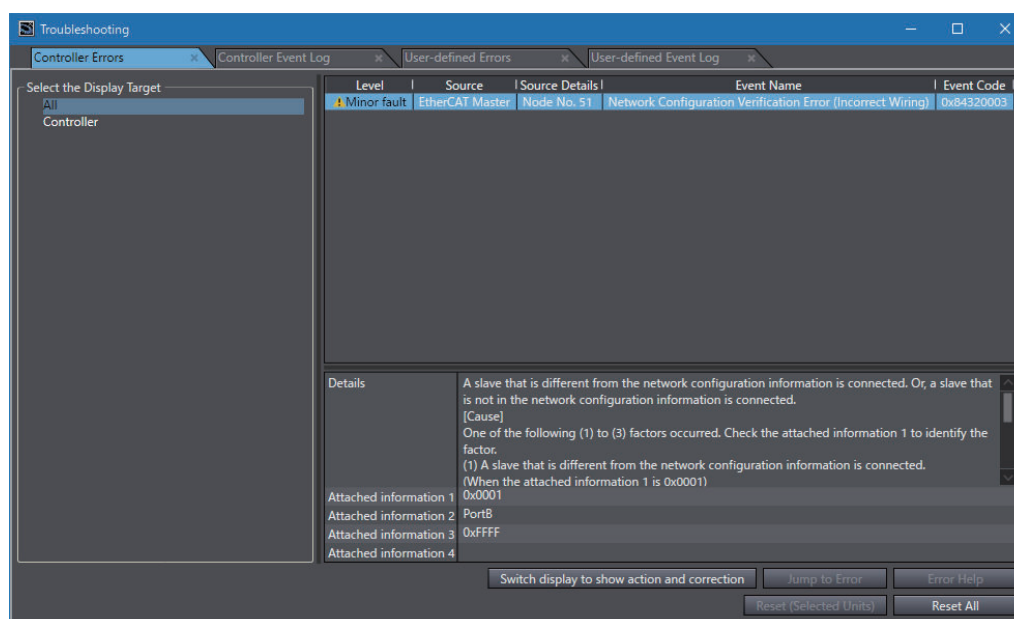

● Information Displayed for Controller Errors and Functions

Item	Description	Remarks
Select the Display Target	Selects the items to display for errors.	
Level	Displays the level of the error.	When a Controller error is displayed, this shows whether it is a major fault, a partial fault, or a minor fault. Observations and information events can be checked in the Controller log.
Source Source Details	Displays the location of the error.	
Event Name	Displays the name of the error.	
Event Code	Displays the event code of the error.	
Details	Describes the error and gives the cause of the error.	
Attached information 1 to 4	Displays supplementary information about the error. The meaning of the data is explained in the details.	
Action and correction	Gives the action and correction that are required to recover from the error.	Select an action and correction to enable the Jump to Error Button if there is a setting that you can correct.
Switch display to show action and correction Button	Switches the display between the details and attached information 1 to 4, and the corrections.	Click the button to switch to the display of Switch display to show details .
Jump to Error Button	Changes the display to the Correction Display in the Sysmac Studio if correcting settings are required.	You cannot jump if the data is not synchronized.
Error Help Button	Displays help if an error in a CJ-series Unit cannot be dealt with in the Sysmac Studio.	

Item	Description	Remarks
Reset All Button	Clears all current errors. Any errors that remain are displayed again.	You cannot clear errors individually.
Reset (Selected Units) Button	Resets any errors in the NX Unit selected in the <i>Select the Display Target</i> Area.	You cannot select this when the selected Unit is not an NX Unit.

● Items Displayed as Sources

Displayed source	Displayed detailed event source	Location of error
PLC	Instruction ^{*1*2*3}	The error occurred in an instruction.
	DB connection service ^{*4}	There is an error in the database connection for a Database Connection CPU Unit.
	SECS/GEM ^{*5}	An error related to SECS/GEM occurred for an SECS/GEM CPU Unit.
	Windows ^{*6}	The Windows was started up or closed on the NY-series Controller, or an error occurred on the Windows.
	Built-in I/O ^{*7}	The error occurred in the built-in I/O of the Controller.
	Option Board ^{*7}	The error occurred in the Option Board that is mounted on the Controller.
	Option Board 1 ^{*7}	The error occurred in Option Board 1 that is mounted on the Controller.
	Option Board 2 ^{*7}	The error occurred in Option Board 2 that is mounted on the Controller.
I/O Bus	Blank	The error occurred in the data processing section of the Controller.
	Master	The error occurred between the Controller and a mounted Unit.
X Bus ^{*8}	Rack No. Slot No.	The error occurred in a Unit that is mounted in the Controller. The Unit where the error occurred is identified by the rack number and slot number.
	Master	The error occurred between the Controller and a mounted Unit.
X Bus Unit common ^{*8}	Unit	The error occurred in a Unit that is mounted on the Controller. The Unit is identified by the Unit number.
	Unit No.	The error occurred in a Unit that is mounted on the Controller. The Unit is identified by the Unit number.
NX Bus ^{*9}	Master	The error occurred between the Controller and a mounted Unit.
	Unit No. (Slot No.)	The error occurred in a Unit that is mounted on the Controller. The Unit where the error occurred is identified by the Unit number and slot number.

Displayed source	Displayed detailed event source	Location of error
EtherNet/IP	Communications port	The error occurred in communications on the built-in EtherNet/IP port on the Controller.
	CIP	The error occurred in a CIP application on the built-in EtherNet/IP port on the Controller.
	FTP	The error occurred in an FTP application on the built-in EtherNet/IP port on the Controller.
	NTP	The error occurred in an NTP application on the built-in EtherNet/IP port on the Controller.
	SNMP	The error occurred in an SNMP application on the built-in EtherNet/IP port on the Controller.
	Communications port 1 ^{*10}	The error occurred in communications on the built-in EtherNet/IP port 1 on the Controller.
	Communications port 2 ^{*10}	The error occurred in communications on the built-in EtherNet/IP port 2 on the Controller.
	Internal port 1 ^{*6}	The error occurred in communications of the internal port 1 on the NY-series Controller.
	CIP1 ^{*10}	The error occurred in a CIP application on the built-in EtherNet/IP port 1 on the Controller.
	CIP2 ^{*10}	The error occurred in a CIP application on the built-in EtherNet/IP port 2 on the Controller.
NX Unit No.	An error occurred in a Unit on a Slave Terminal.	
Ethernet	FTP	The error occurred in an FTP application on the built-in Ethernet port on the Controller.
	NTP	The error occurred in an NTP application on the built-in Ethernet port on the Controller.
	SNMP	The error occurred in an SNMP application on the built-in Ethernet port on the Controller.
	Communications port 1	The error occurred in communications on the built-in Ethernet port 1 on the Controller.
	Communications port 2	The error occurred in communications on the built-in Ethernet port 2 on the Controller.
EtherCAT	Communications port	The error occurred in communications on the built-in EtherCAT port on the Controller.
	Master	The error occurred in the master for the built-in EtherCAT port on the Controller.
	Node No.	The error occurred in a slave connected to the built-in EtherCAT port on the Controller.
	NX Unit	The error occurred in a Unit on a Slave Terminal connected to the built-in EtherCAT port on the Controller.
Motion Control	Common items	The error occurred in the Axis Common section of the Controller's Motion Control Function Module.
	Axis No.	The error occurred in an axis in the Controller's Motion Control Function Module.
	Axes Group No.	The error occurred in an axes group in the Controller's Motion Control Function Module.

*1. "Instruction" is displayed only in the Controller event logs.

*2. "Instruction" is displayed only if outputting instruction errors is enabled in the *Event Log Settings* of the Controller Setup.

*3. "Instruction" is displayed only if the unit version of the connected CPU Unit is 1.02 or later.

- *4. This error is displayed only for an NJ-series Database Connection CPU Unit. Refer to the *NJ/NX-series Database Connection CPU Units User's Manual (Cat. No. W527)* for details on errors.
- *5. This error is displayed only for an NJ-series SECS/GEM CPU Unit. Refer to the *NJ-series SECS/GEM CPU Units User's Manual (Cat. No. W528)* for details on errors.
- *6. This is displayed only for an NY-series Controller.
- *7. This is displayed only for an NX1P2 Controller.
- *8. This is displayed only for an NX502 Controller.
- *9. This is displayed only for an NX502, NX102, or NX1P2 Controller.
- *10. This is displayed only for an NX701 Controller and NX102 Controller.

● Procedure

Changing to the Correction Display

- 1** Check the **Details** and **Attached Information** Areas to check the details and cause of an error.
- 2** Check the method to correct the error in the **Action and correction** Area.

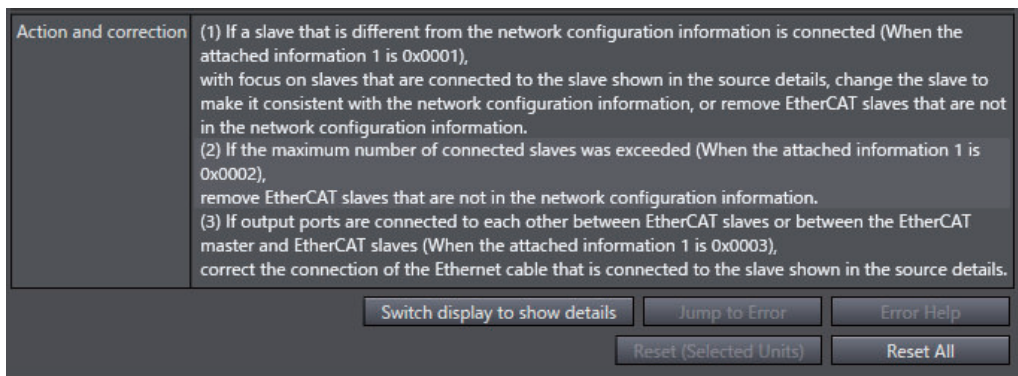

- 3** Select the correction to make. If there is more than one correction, select one correction to actually perform.

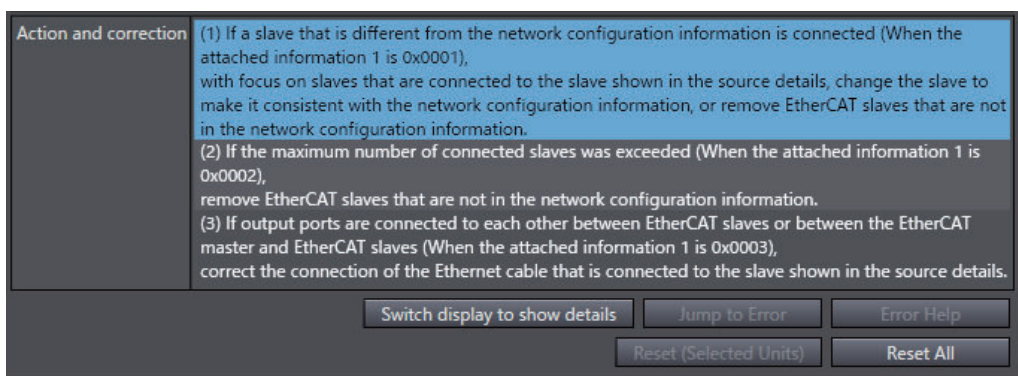

If you select a correction that allows you to jump to the Correction View, the **Jump to Error** Button is enabled.

- 4** Click the **Jump to Error** Button.
The display changes to the display for correcting the settings.
- 5** Correct the settings while the Sysmac Studio is offline.

● Changing the Display Order

You can click the **Level** or **Source** heading to sort the errors by that item. The events are displayed in order of event levels by default.

Example: Changing the Display Order

Entry	Time	Level	Source	Source D
0007	1/1/1970 9:00:03 AM	Minor fault	PLC	
0008	1/1/1970 9:00:03 AM	Minor fault	PLC	
0009	1/1/1970 9:00:03 AM	Minor fault	PLC	
0010	1/1/1970 9:00:03 AM	Minor fault	PLC	
0011	1/1/1970 9:00:03 AM	Minor fault	PLC	
0012	1/1/1970 9:00:03 AM	Minor fault	PLC	
0014	1/1/1970 9:00:03 AM	Minor fault	PLC	
0015	1/1/1970 9:00:05 AM	Major fault	I/O bus	Master
0016	1/1/1970 9:00:05 AM	Major fault	I/O bus	Master
0017	1/1/1970 9:00:05 AM	Major fault	I/O bus	Master
0018	1/1/1970 9:00:05 AM	Major fault	I/O bus	Master
0022	1/1/1970 9:00:05 AM	Observation	EtherNet/IP	Communicat

Click **Source**.

Entry	Time	Level	Source	Source Details	Event Name	Event Code
0170	7/7/2011 3:29:27 PM	Minor fault	PLC		Low Battery Voltage	0x000B0000
0178	7/7/2011 3:30:42 PM	Minor fault	PLC		Low Battery Voltage	0x000B0000
0187	7/7/2011 3:32:11 PM	Minor fault	PLC		Low Battery Voltage	0x000B0000
0167	7/7/2011 3:29:07 PM	Minor fault	PLC		Low Battery Voltage	0x000B0000
0154	7/7/2011 3:20:18 PM	Minor fault	PLC		Low Battery Voltage	0x000B0000
0157	7/7/2011 3:21:25 PM	Minor fault	PLC		Low Battery Voltage	0x000B0000
0163	7/7/2011 3:28:39 PM	Minor fault	PLC		Low Battery Voltage	0x000B0000
0193	7/7/2011 3:55:21 PM	Minor fault	PLC		Low Battery Voltage	0x000B0000
0228	7/7/2011 4:28:39 PM	Minor fault	PLC		Low Battery Voltage	0x000B0000
0236	7/7/2011 4:37:30 PM	Minor fault	PLC		Low Battery Voltage	0x000B0000
0247	7/7/2011 4:41:47 PM	Minor fault	PLC		Low Battery Voltage	0x000B0000
0224	7/7/2011 4:19:11 PM	Minor fault	PLC		Low Battery Voltage	0x000B0000

8-16-3 Controller Event Log

You can display a log of Controller events (including Controller errors and Controller information). (The logs in EtherCAT slaves are not displayed.)

Entry	Time	Level	Source	Source Details	Event Name	Event Code	Username
C_0033A	2021/04/14 13:57:03	Information	PLC		Online Connection Started	0x90030000	user01
C_0032A	2021/04/14 13:48:47	Information	PLC		Online Connection Started	0x90030000	user02
C_0031A	2021/04/14 13:48:33	Information	PLC		Authentication Setting Tran	0x90170000	user01
C_0030A	2021/04/14 13:44:01	Information	PLC		Online Connection Started	0x90030000	user01
C_0076S	2021/04/14 13:41:18	Information	EtherNet/IP	Communications port	Link Detected	0x84050000	
C_0075S	2021/04/14 13:41:16	Observation	EtherNet/IP	Communications port	Link OFF Detected	0x84060000	
C_0074S	2021/04/14 13:39:21	Information	EtherNet/IP	Communications port	Link Detected	0x94050000	
C_0073S	2021/04/14 13:39:17	Observation	EtherNet/IP	Communications port	Link OFF Detected	0x84060000	
C_0072S	2021/04/14 13:37:29	Information	EtherNet/IP	Communications port	IP Address Fixed	0x94080000	
C_0071S	2021/04/14 13:37:29	Information	EtherNet/IP	Communications port	Link Detected	0x94050000	
C_0070S	2021/04/14 13:37:29	Information	PLC		Operation Started	0x90130000	
C_0069S	2021/04/14 13:37:24	Information	PLC		Power Turned ON	0x90110000	
C_0068S	2021/04/14 11:05:48	Information	PLC		Power Interrupted	0x90120000	

Details: The authentication setting was transferred. [Cause] The authentication setting was transferred.

Attached information 1
Attached information 2
Attached information 3
Attached information 4

109 events Last data logged at 2021/04/14 13:59:52

List of Controller Event Log Contents and Functions

Item	Meaning	Remarks
Select the Display Target	Selects the items to display in the log.	
Displayed Information	This switches the information displayed between the system event log and the access event log.	The log contents in the CJ-series Unit is treated as a system event log.
Level	Changes the information displayed according to the event levels.	
Entry	Displays events with serial numbers by event source and by event log type.	Refer to <i>Display Details for Entries</i> on page 8-127 described later for details.
Time	Displays the time and date that the event occurred.	This is time and date information stored in the Controller. The date for events without occurrence time information is displayed as "----/-- --:--:--".
Level	Displays the event level.	Refer to <i>8-16-2 Controller Errors</i> on page 8-121 for information on the displayed contents.
Source Source Details	Displays the location of the event.	Refer to <i>8-16-2 Controller Errors</i> on page 8-121 for information on the displayed contents.
Event Name	Displays the event name.	
Event Code	Displays the event code.	
Username	Displays the user name that was connected online when the event occurred.	
Occurrence Number ^{*1}	Displays the order of occurrence of the event by a serial number starting from 1, without distinction between system event and access event logs.	
Details	Displays the contents and cause of the event log that was read.	
Attached information 1 to 4	Displays supplementary information about the event log that was read. The meaning of the data is explained in the details.	
Action and correction	Gives the action and correction that are required to recover from the error.	The location to edit is displayed if you select a correction.
Switch display to show action and correction Button	Switches the display between the details and attached information 1 to 4, and the corrections.	Click the button to switch to the display of Switch display to show details .
Update Button	Reads and displays the log again.	The display is not automatically updated. The display is updated at the following times. <ul style="list-style-type: none"> • When you open the Troubleshooting Dialog Box • When you click the Reload Button.
Print Button	Prints the displayed log information.	Log information that is not displayed due to the Displayed Information selections is not printed.

Item	Meaning	Remarks
Save Button	Saves the event log information into a Viewer format file or CSV format file.	All of the event log information is saved regardless of the display settings. Use the <i>Event Log Viewer</i> to open a file saved in Viewer format, and you can check the contents offline.
Clear Button	Deletes the display log.	If the system event log is cleared, the CJ-series Unit log is also cleared.
Error Help Button	Displays the causes of and details on errors.	---

*1. This is displayed only for events that occurred in an NX502 CPU Unit.



Precautions for Correct Use

The Controller event logs display information on events that have occurred. The information that is displayed in the logs may not reflect the current status of the Controller or programs. Use this information as reference only.



Additional Information

- To find out the timing of events that do not have time information in the NX Unit, select the NX Unit in the *Select the Display Target* Area and check the order of occurrence of the events with the numerical order of the entries.
- You can check the location of the event on the configuration of the EtherCAT network by right-clicking in the Controller Event Log Tab Page and selecting **Display EtherCAT Configuration Information (Event Log)** from the pop-up menu. For details, refer to the *NJ/NX-series CPU Unit Built-in EtherCAT Port User's Manual (Cat. No. W505)* or *NY-series Industrial Panel PC / Industrial Box PC Built-in EtherCAT Port User's Manual (Cat. No. W562)*.

● Display Details for Entries

Entries are displayed as follows according to the event sources and log types.

Serial numbers are assigned to events in chronological order of occurrence.

Device/log type	Display format	Description	Display example
Controller System Event Log	C_[nnnn]S	[nnnn]: Serial number	C_0001S
Controller Access Event Log	C_[nnnn]A	[nnnn]: Serial number	C_0001A
System Event Log for NX Unit on CPU Rack	U[aaa]_[nnnn]S	[aaa]: Unit number [nnnn]: Serial number	U063_0001S
Access Event Log for NX Unit on CPU Rack	U[aaa]_[nnnn]A	[aaa]: Unit number [nnnn]: Serial number	U063_0001A
System Event Log for X Bus Unit on CPU Rack	X[bbb]_[nnnn]S	[bbb]: Unit number [nnnn]: Serial number	X001_0001S
CJ-series Unit Log	R[aa]_SI[bb]_[nnnn]S	[aa]: Rack number [bb]: Slot number [nnnn]: Serial number	R01_SI02_0001S
EtherCAT Slave Log	N[aaa]_[nnnn]S	[aaa]: Node No. [nnnn]: Serial number	N001_0001S

Device/log type	Display format	Description	Display example
System Event Log for NX Unit on EtherCAT Slave Terminal (Controller connection)	N[aaa]_U[bbb]_[nnnn]S	[aaa]: Node No. [bbb]: Unit number [nnnn]: Serial number	N001_U063_0001S
Access Event Log for NX Unit on EtherCAT Slave Terminal (Controller connection)	N[aaa]_U[bbb]_[nnnn]A	[aaa]: Node No. [bbb]: Unit number [nnnn]: Serial number	N001_U063_0001A
System Event Log for NX Unit on EtherCAT Slave Terminal (EtherCAT slave terminal direct connection)	U[aaa]_[nnnn]S	[aaa]: Unit number [nnnn]: Serial number	U063_0001S
Access Event Log for NX Unit on EtherCAT Slave Terminal (EtherCAT slave terminal direct connection)	U[aaa]_[nnnn]A	[aaa]: Unit number [nnnn]: Serial number	U063_0001A

● Changing the Display Order

You can click the **Time**, **Level**, or **Source** heading to sort the errors by that item. The events are displayed in order of dates by default.

● Selecting the Display Range of Event Logs

You can specify the range of event occurrence dates to display event logs in a specific range.

- 1** Right-click the mouse over the target event log row, and select **Show only ones newer than the selected** or **Show only ones older than the selected**.
Only the event logs with the dates corresponding to the selected menu option will be displayed.
- 2** Right-click the mouse over the event log row with the date to be used for specifying the range, and select **Show only ones newer than the selected** or **Show only ones older than the selected**.
According to the selected menu option, the display range of event logs will be narrowed down. Repeat this to further narrow down the range of dates of event logs to be displayed.
- 3** To clear the narrowed-down results, right-click the mouse and select **Clear the filter for 'Time'**.

Saving Controller Event Log

- 1** Click the **Save** button.
The dialog box to select the file format is displayed.

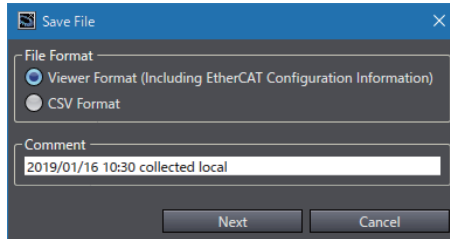

File format	Description
Viewer Format (Including EtherCAT Configuration Information)	Select this format to read and display data offline with the Event Log Viewer.
CSV Format	Select this format to display data with spreadsheet software such as Excel.

- 2 Select the file format for saving data, enter any comment, and click the **Next** Button. The **Save File** Dialog Box is displayed.
- 3 Enter a file name, and then click the **Save** Button. When Viewer Format is selected, a file with a .xml extension is saved. When CSV Format is selected, a file with a .csv extension (comma-separated) is saved.



Precautions for Correct Use

The saved CSV file of the Controller event log is encoded in UTF-8 character codes.

8-16-4 User-defined Errors

You can display information on current errors.

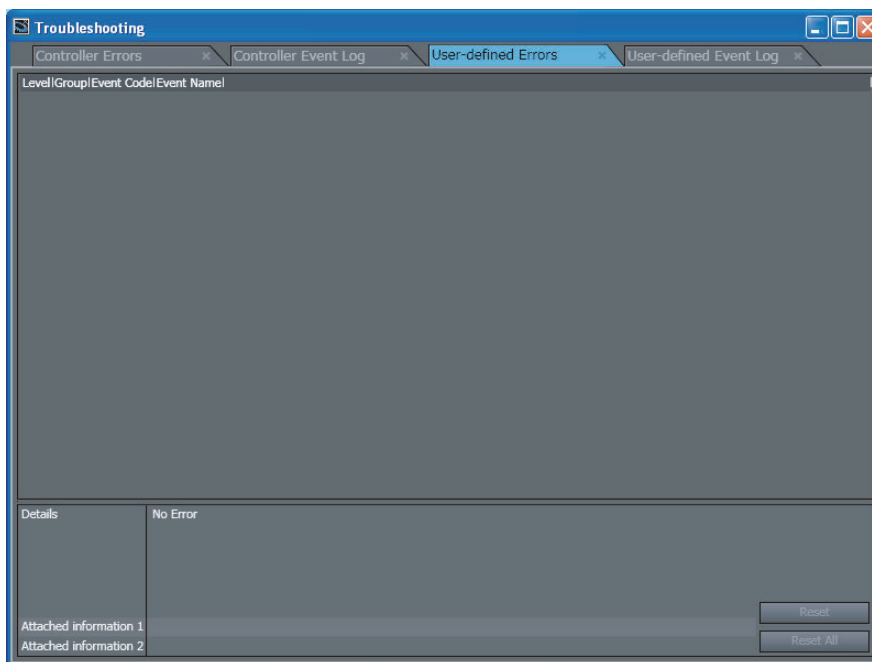

● Information Displayed for User-defined Errors and Functions

Item	Description	Remarks
Level	Displays the event level categorized by the event code.	You can change the name of the event level in the Event Setting Table.
Group	Displays the group registered in the Event Setting Table.	
Event Code	Displays the event code.	
Event Name	Displays the event title registered in the Event Setting Table.	
Details	Displays the event message registered in the Event Setting Table.	
Attached information 1 and 2	Displays the values for the Info1 and Info2 input parameters for the Create User-defined Error (SetAlarm) instruction and the Create User-defined Information (SetInfo) instruction.	
Reset Button	Resets the selected user-defined event.	
Reset All Button	Resets all user-defined events.	



Additional Information

Only the contents registered in the Language 1 Event Setting Table is shown in the User-defined Error Tab Page. The contents registered for Languages 2 to 9 are not displayed.

8-16-5 User-defined Event Log

The log of user-defined events that were stored for the Create User-defined Error (SetAlarm) instruction and the Create User-defined Information (SetInfo) instruction is displayed.

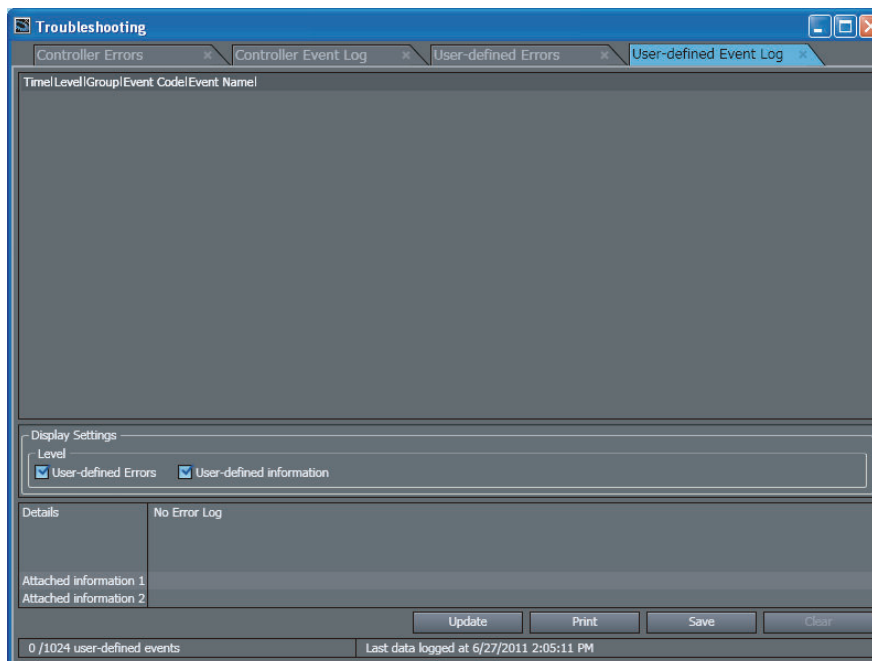

● Information Displayed for User-defined Event Log and Functions

Item	Description	Remarks
Time	Displays the time and date that the user-defined event occurred.	This is time and date information stored in the Controller.
Level	Displays the event level of the user-defined event.	Refer to <i>8-16-4 User-defined Errors</i> on page 8-129 for information on the displayed contents.
Group	Displays the group name of the user-defined event.	
Event Code	Displays the event code of the user-defined event.	
Event Name	Displays the user-defined event name.	
Display Settings, Level	Switches the view between user-defined errors (event codes 1 to 40,000) and user-defined information (event codes 40,001 to 60,000).	Only user-defined errors are displayed by default.
Details	Displays a description of the event that corresponds to the event code registered in the Event Setting Table.	Of Languages 1 to 9 in the Event Setting Table, only the contents registered for Language 1 is displayed. You cannot switch to Languages 2 to 9.
Attached Information 1 and 2	Displays the values for the Info1 and Info2 input parameters for the Create User-defined Error (SetAlarm) instruction and the Create User-defined Information (SetInfo) instruction.	
Update Button	Reads and displays the log again.	The display is not automatically updated. The display is updated at the following times. <ul style="list-style-type: none"> • When you open the Troubleshooting Dialog Box • When you click the Reload Button.
Print Button	Prints the event log.	
Save Button	Saves the event log to a CSV file.	
Clear Button	Deletes the user log.	

● Changing the Display Order

You can click the **Time**, **Level**, **Group**, or **Event Code** heading to sort the events by that item. The events are displayed in order of dates by default.



Precautions for Correct Use

The saved CSV file of the user-defined event log is encoded in UTF-8 character codes.

8-16-6 Event Setting Table

The Event Setting Table is used to register the contents displayed on the Sysmac Studio and on HMIs for user-defined events that occur for execution of the Create User-defined Error (SetAlarm) instruction and the Create User-defined Information (SetInfo) instruction.

- You can register the items that are described below (event name, level, group, and details) for each event code.
- You can register up to 5,120 events in the Event Setting Table.

- You can copy data created in Excel and paste it into the Event Setting Table.
- You can also directly edit the Event Setting Table.

● Event Name

Register the title of each user-defined event.

If the title is not registered, “User Fault Level 1” to “User Fault Level 8” or “User-defined Information” is displayed.

● Level

The level of user-defined event is automatically determined according to the event code as shown in the following table.

The name of the level is registered according to the level.

Event code	Level	Default title setting	Remarks
1 to 5000	High	User fault level 1	These event codes are used in the Create User-defined Error (SetAlarm) instruction.
5001 to 10000	↑	User fault level 2	
10001 to 15000	↑	User fault level 3	
15001 to 20000	↑	User fault level 4	
20001 to 25000	↑	User fault level 5	
25001 to 30000	↑	User fault level 6	
30001 to 35000	↑	User fault level 7	
35001 to 40000	↑	User fault level 8	
40001 to 60000	Low	User-defined Information	These event codes are used in the Create User-defined Information (SetInfo) instruction.

If the level name is not registered, “User Fault Level 1” to “User Fault Level 8” or “User-defined Information” is displayed.

● Group

Register the group names to indicate the location and type of each user-defined event.

● Details

Register a detailed description of the user-defined event.

The contents registered in the Event Setting Table and the contents displayed in the Troubleshooting Dialog Box and on an HMI have the following relationship.

Parameters in the Event Setting Table

Event Cod	Event Name	Event Level	Group	Details
1	Monitoring of alarm	User fault Level 1	No. 1 Equipment	If the temprature is too high, please stop it emergently.

Information That Is Displayed on the HMI or Troubleshooting Dialog Box

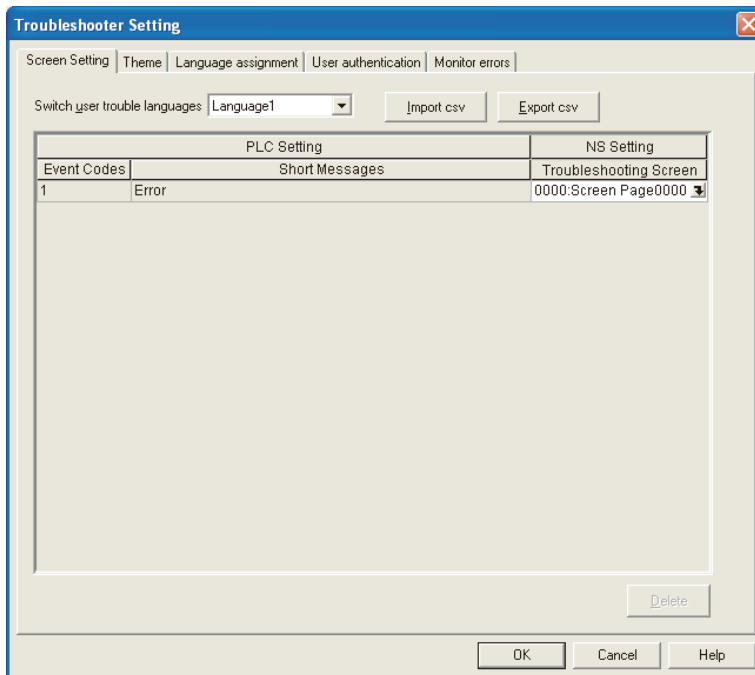

If you use more than one label on the NS-series PT, create more than one language table in the Event Setting Table.

You can edit up to nine languages in the Event Setting Table.

8-16-7 Displaying and Editing the Event Setting Table

This section provides the procedures for displaying and editing the Event Setting Table.

● Displaying the Event Settings Table

Double-click **Event Settings** under **Configurations and Setup** in the Multiview Explorer. Or, right-click **Event Settings** under **Configurations and Setup** and select **Edit** from the menu.

The Editing Pane for the Event Setting Table is displayed.

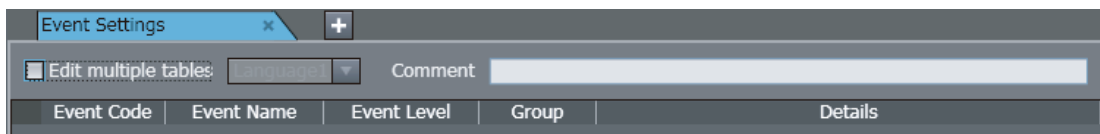

● Displaying and Editing the Event Settings Table

	Item	Description	Remarks
Event Settings Table	Event Code	You can specify a number to identify the event according to the event level.	User-defined errors: 1 to 40,000 User-defined information: 40,001 to 60,000
	Event Name	You can include a title for the event.	128 characters max.
	Event Level	You can specify the level of the event. The level is indicated with a number. The lower the number is, the higher the level is.	32 characters max. There are no restrictions on the characters that can be used. Case sensitive. Reserved words: None
	Group	You can specify a group name to represent the location or type of the event. You can use user-defined groupings for the events.	32 characters max. There are no restrictions on the characters that can be used. Case sensitive. Reserved words: None
	Details	You can include a message that describes the event. The user can enter any text string. The message is used when the event is displayed on the Sysmac Studio or an HMI.	1,024 characters max. You can enter carriage returns in the text, but each carriage return is counted as one character.
	Register the detailed description to display on the HMI when a Controller error in the major fault level occurs.	Register the detailed description to display on the HMI when a Controller error in the major fault level occurs. When a major fault occurs, the text registered here is displayed in the Troubleshooter Screen of the HMI.	You can register up to 128 characters. You can enter carriage returns in the text, but each carriage return is counted as one character.
	Comment	The comment is attached for each set of table entries.	

● Copying from Excel to the Event Settings Table

This section describes the procedure to copy contents created in Excel to the Event Settings Table. You can also directly edit information in the Event Settings Table.

- 1 Use the following format to create data in Excel.

	A	B	C	D	E
1	Event Code	Event Name	Event Level	Group	Details
2	1	Error	User fault Level 1	No.1	The in-furnace temperature is an expected value. Please urgent stop.

- 2 Right-click the part to copy and select **Copy** from the menu.

	A	B	C	D	E
1	Event Code	Event Name	Event Level	Group	Details
2		Error	User fault Level 1	No.1	The in-furnace temperature is an expected value. Please urgent stop.

- 3 Right-click the Event Settings Table and select **Paste** to paste the data.

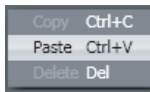

● Copying from the Event Settings Table to Excel

This section describes the procedure to copy the contents of the Event Settings Table to Excel.

- 1 Select the section to copy in the Event Settings Table.

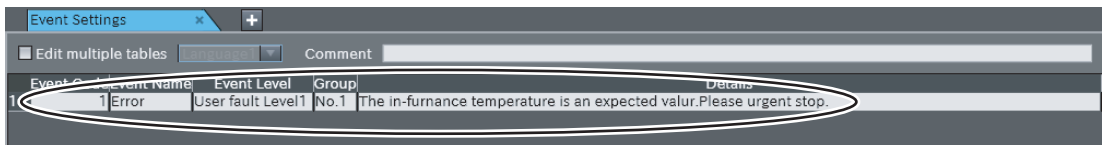

- 2 Right-click the Event Settings Table and select **Copy**.

- 3 Paste the data in Excel.

The data is pasted as shown below.

	A	B	C	D	E
1	Event Code	Event Name	Event Level	Group	Details
2	1	Error	User fault Level 1	No.1	The in-furnance temperature is an expected value. Please urgent stop.

● Editing Multiple Tables

You can create more than one language table in an Event Settings Table to change the contents that is displayed for different HMI labels.

- 1 Select the **Edit multiple tables** Check Box in the Event Settings Table.



- 2 Select the language to edit from *Language 2* to *Language 9*.

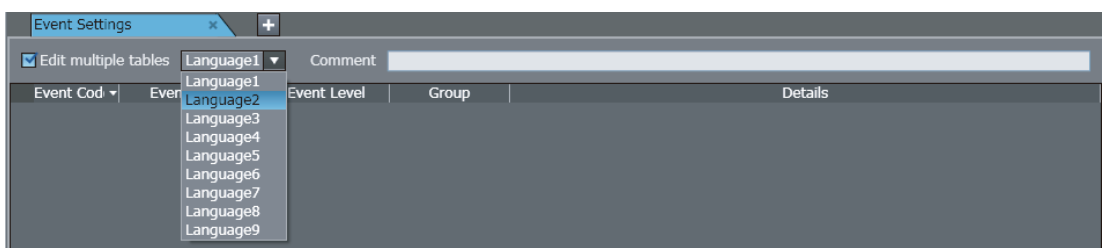

- 3 Use the same method as in *Copying from Microsoft Excel to the Event Settings Table*, above.
Select and copy the target data that was created in Excel.
- 4 Right-click the Event Settings Table and select **Paste** to paste the data.



Additional Information

Multiple language tables in an Event Setting Table are used to add display contents for the event registered for Language 1. You cannot use Language 2 to Language 9 to create more events. (You cannot change the event code field.)

To add an event, set the event for Language 1 in an Event Setting Table.

● Referring to the Other Languages When Editing an Event Settings Table

The contents registered for other languages in the Event Settings Table is displayed when the mouse is placed on an event.

Example: When Editing the Event Settings Table for Language 1

The contents registered for Language 2 to Language 9 is displayed.

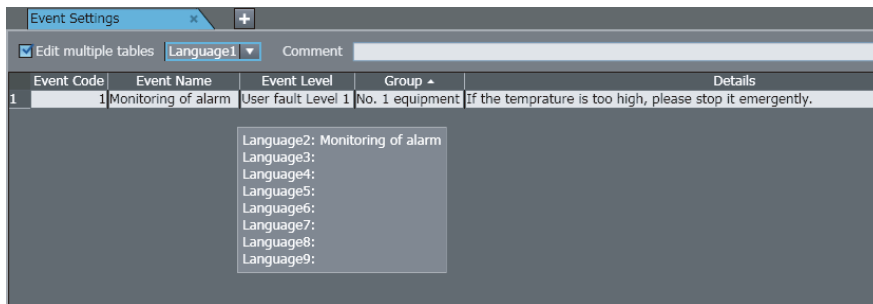

Example: When Editing the Event Settings Table for Language 2 to Language 9

The contents registered for Language 1 is displayed.

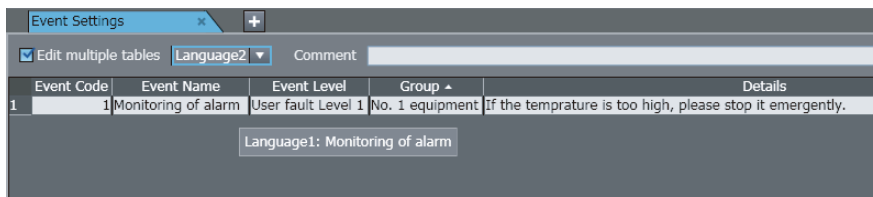

8-16-8 Exporting the Event Setting Table

Export the Event Setting Table as user-defined event definition information for the SYSMAC Gateway Event Log Utility. Refer to the *SYSMAC Gateway Help* for how to use user-defined event definition information.

● Exported Items

The following items in the Event Setting Table are exported.

- Event Code
- Event Name
- Event Level

- Group
- Details

The detailed description and comments to display on the HMI are not output when a Controller error in the major fault level occurs.

Refer to *8-16-7 Displaying and Editing the Event Setting Table* on page 8-133 for details on the Event Setting Table.

● Export Procedure

- 1 Select **SYSMAC Gateway – Export User Event Definition File** from the **Tools** Menu. A dialog box for selecting the export destination folder is displayed.

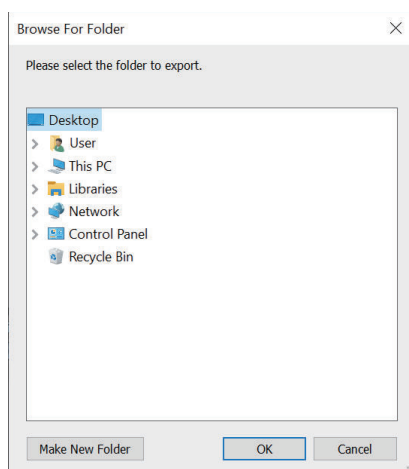

- 2 Select the export destination folder and click the **OK** Button.
- 3 When a message that shows the completion of export is displayed, click the **OK** Button.

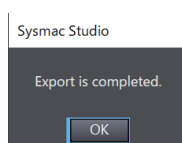

User-defined event definition information in nine languages is saved in xml file format, which you can load into the SYSMAC Gateway's Event Log Utility.

8-16-9 Event Log Viewer

In the Event Log Viewer, you can display controller event logs saved in a file in offline state. Controller event logs must be saved into a *Viewer Format* file (hereinafter called “controller event log file”) in advance in the **Troubleshooting** Dialog Box. Refer to *Saving Controller Event Log* on page 8-128 for the procedure to save data into a file.

● Event Log Viewer Operating Procedure

- 1 Select **Tools - Event Log Viewer** from the main menu.

The controller event log file selection dialog box is displayed.

- 2 Select the target controller event log file, and then click the **Open** Button.
The **Event Log Viewer** Dialog Box starts, and the selected controller event logs are displayed.

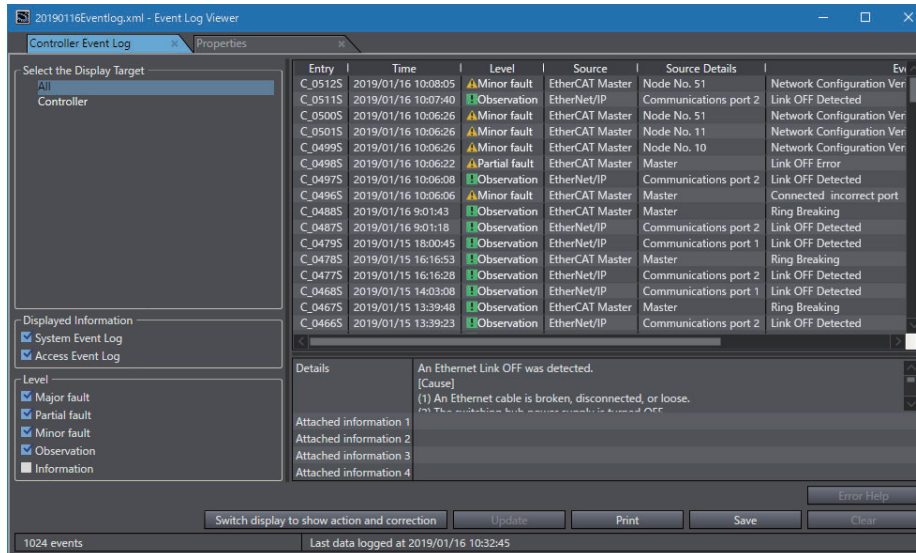

The displayed contents are the same as those of the controller event logs displayed in the **Troubleshooting** Dialog Box.



Additional Information

- Data can be saved into a file from the **Event Log Viewer** Dialog Box in CSV format only.
- The **Update** Button and the **Clear** Button are grayed out.

● Displaying Controller Event Log File Properties

In the **Event Log Viewer** Dialog Box, you can display the properties of the currently displayed controller event logs.

- 1 Select the **Properties** Tab in the **Event Log Viewer** Dialog Box.
The **Properties** are displayed.

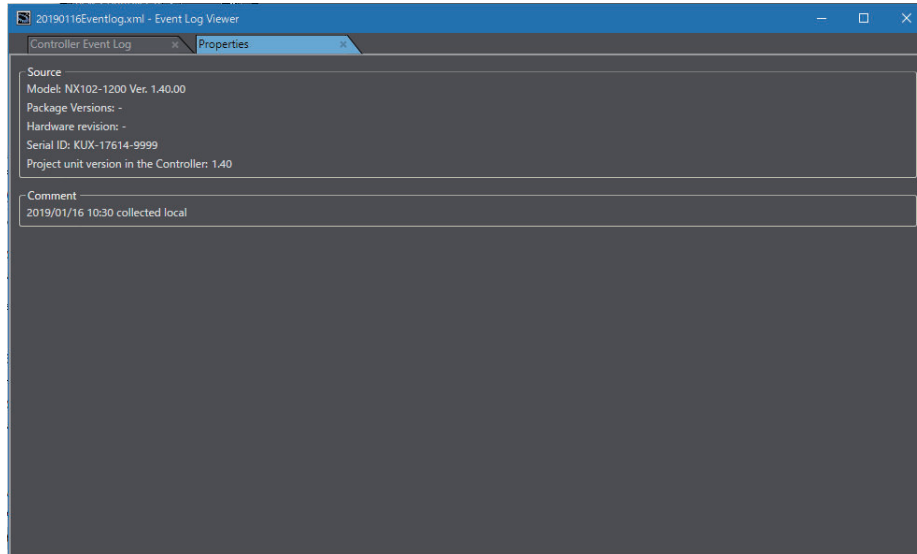

The controller information and comments when the controller event logs were obtained are displayed in the **Properties** Tab.

8-17 Changing Variable Comments and Data Type Comments

You can switch the comments that are displayed for variables and data types. You can use this to globally switch all of the comments for variables and data types that are used in a Controller in a project. You can export the comments from the Controller, translate them into a different language or change them to different comments, import them, and then switch all of the comments that are displayed.

Also, you can edit the display comments and switchable comments simultaneously from a variable table.

8-17-1 Exporting Comments

- 1 Select the Controller from which to export the comments, and then select **Comments for Variables and Data Types (For switching) - Export** from the **Tools** Menu.

The **Properties** are displayed.

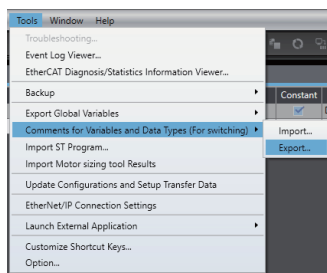

A Save File Dialog Box is displayed.

- 2 Enter the file name, and then click the **Save** Button.
The comments are saved in a CSV file.



Additional Information

Comments for variables and data types for which display is prohibited with data protection are not exported. To export these comments, temporarily release the data protection.

8-17-2 Editing the Comment File

Use the following procedure to edit the CSV file that you exported.

- 1 Open the CSV file in a spreadsheet software application.
CSV File Format

	(1)	(2)	(3)	(4)	(5)	(6)	(7)
A	B	C	D	E	F	G	H
Sysmac Studio Exported Comments File	ID	Table Type	Type	Namespace	Name	Comment1	Comment2
	{D}\6b268a06-68ea-4727-af76-856764c1936f}	Global			LS_AA1	Limit SW of AA1	
	{D}\ebaef10f-5497-4ee1-a1a6-c949e7905828}	Global			LS_AA2	Limit SW of AA2	
	{D}\22d0e93c-282a-4eb2-8a0b-fe676b647285}	Global			LS_AS1	Limit SW of AS1	
	{D}\12df3201-18ae-40bd-b482-52cb30f9c827}	Global			LS_AL1	Limit SW of AL1	
	{D}\8744b06a-a405-4859-8c76-2e0581a7b622}	Program0	VAR		RED		
	{D}\d5f9c44-b8b8-4c44-8d56-c1a7c3d4f4a8}	Program0	VAR		GREEN		

No.	Item	Description	Remarks
1	ID	ID numbers are automatically assigned to the variables and data types.	Do not change this item.
2	Table Type	Gives the table type. Global: Global variable table POU name: Local variable table Type: Data type table	Do not change this item.
3	Type	Gives the classification in the local variable table. Internal: Internal variable External: External variable input,output: Input or output variable inout: In-out variable return: Return value	Do not change this item.
4	Namespace	Gives the name of the namespace of the data type.	Do not change this item.
5	Name	Gives the name of the variable or data type.	Do not change this item.
6	Comment 1	Gives the comment registered for display.	
7	Comment 2	Gives the comment registered for switching. Enter the comment for switching.	

2 Enter the comment for switching in the *Comment 2* column. If the cell for comment 2 is left empty, the comment will be blank.

3 Save the CSV file.



Precautions for Correct Use

- Only array elements for which comments are registered are exported. Elements that have no comments are not exported to the CSV file. To add or correct a comment of an element, export/import variable comments. Refer to *Exporting/Importing Variable Comments* on page 4-47 for details.
- Do not change the names of the items in the exported file. If you change these, you will not be able to import the file.

8-17-3 Importing Comment Files

Use the following procedure to import the CSV file that you edited to the project.

1 Select the Controller to which to import the comments, and then select **Comments for Variables and Data Types (For switching) - Import** from the **Tools** Menu.

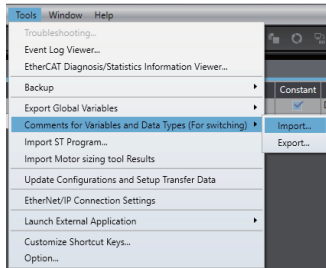

A Select File Dialog Box is displayed.

- 2 Select the CSV file to import, and then click the **Open** Button.
A dialog box is displayed to confirm the import operation.
Click the **OK** Button. The comments are imported and the comments in the project are replaced with the comments in the CSV file.
If an error occurs while importing the comments, it is displayed in the Output Tab Page.



Precautions for Correct Use

- When you import comments from a CSV file, all of the previous comments in the specified Controller in the project are overwritten with the comments in the CSV file. You cannot undo this operation.
- If you delete the comments for any array elements in the project after you export the comments, the comments will not be imported for those elements.
- If you export comments for union variables or array elements in union array variables from Sysmac Studio version 1.07 or higher and then import them into Sysmac Studio version 1.06, the comments will be lost.



Additional Information

Comments for variables and data types for which changes are prohibited with data protection are not imported. To import these comments, temporarily release the data protection.

8-17-4 Switching the Displayed Comments

Use the following procedure to display the new comments from the imported comment file.

- 1 Select **Option** from the **Tools** menu. The Option Dialog Box is displayed.

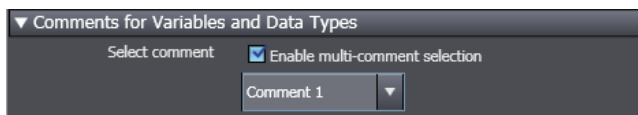

- 2 Select the **Enable multi-comment selection** Check Box for **Select comment** in the **Comments for Variables and Data Types** Area, select the comments to display, and then click the **OK** Button.
The new comments are displayed if you display a variable table or the Ladder Editor.



Precautions for Correct Use

If you open a project to which comments were imported from a CSV file on a version of the Sysmac Studio that does not support switching comments, the comments will not be displayed correctly.



Additional Information

The comments that are switched on the display can be edited as usual, i.e., in a variable table or in the Data Type Editor.

8-17-5 Procedure to Edit Switchable Comments in Variable Tables

You can edit the display comments and switchable comments simultaneously from a variable table. To use this function, you need to select the **Enable multi-comment selection** Check Box in the option settings. Refer to *8-26 Sysmac Studio Option Settings* on page 8-166 for details on the option settings.

- 1 Right-click in the variable table that has the variable element comments you want to edit, and select **Show Switchable Comment Setting Dialog (including element comments) – Selected variables** or **All variables in this view** from the menu.

The following shows an example where **Selected variables** is selected.

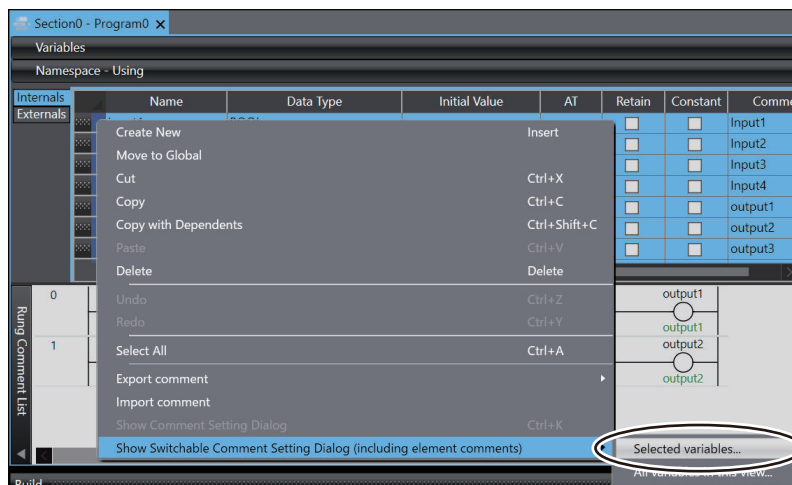

The **Switchable Comment Setting** Dialog Box is displayed.

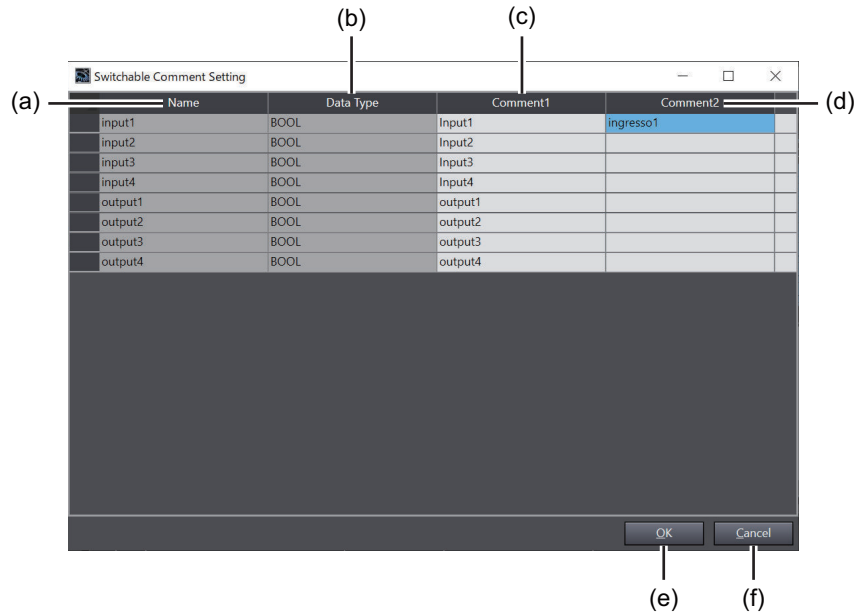

No.	Item	Description	Editing
(a)	Name	Gives the variable name.	---
(b)	Data Type	Gives the data type name.	---
(c)	Comment1	Gives the comment registered for display.	○*1
(d)	Comment2	Gives the comment registered for switching. Enter the comment for switching.	○*1
(e)	OK Button	Applies the edited contents of comments 1 and 2 to the variable table.	---
(f)	Cancel Button	Discards the edited contents of comments 1 and 2.	---

*1. The comment can be edited when the following conditions are met.

- The status must be offline.
- If the status is online, the variable table must be the target of online editing.
- It must be a variable in a POU that is not protected with the change prohibition setting

2 Edit the contents of **Comment1** and **Comment2**.

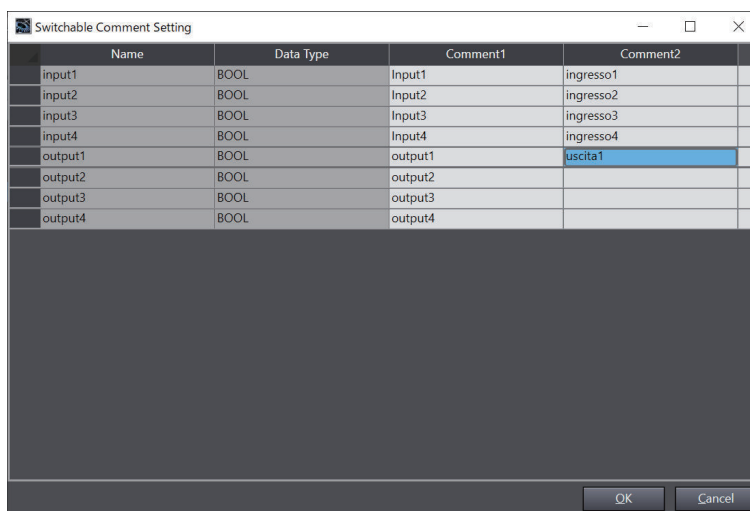

3 Click the **OK** Button.

A change confirmation dialog box is displayed.

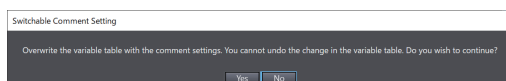

- 4** Click the **Yes** Button.
The edited comments are applied to the variable table.



Precautions for Correct Use

Applying the contents edited in the **Switchable Comment Setting** Dialog Box overwrites the existing comments for the target variables in the project, which means that you cannot undo the changes.



Additional Information

- The comments edited in the **Switchable Comment Setting** Dialog Box are the target of export. Refer to *8-17-1 Exporting Comments* on page 8-140 for details.
 - If you enable **Use global variable comment** in the option settings, you cannot edit the switchable comments for external variables. Refer to *8-26 Sysmac Studio Option Settings* on page 8-166 for details on the option settings.
 - For variables that are defined in libraries, you cannot edit switchable comments.
-

8-18 Exporting the Program Hash Code

Use this function to output the program hash code to a CSV file. Comparing the program hash code allows you to detect changes in the user program. The program hash code to be output is the same as the program hash code that you get using the GetPrgHashCode instruction of NJ/NX-series Controllers.

Refer to the *NJ/NX-series Instructions Reference Manual (Cat. No. W502)* for details on the GetPrgHashCode instruction.

● Procedure for Exporting the Program Hash Code

- 1 Select **Export Program Hash Code** from the **Tools** Menu.

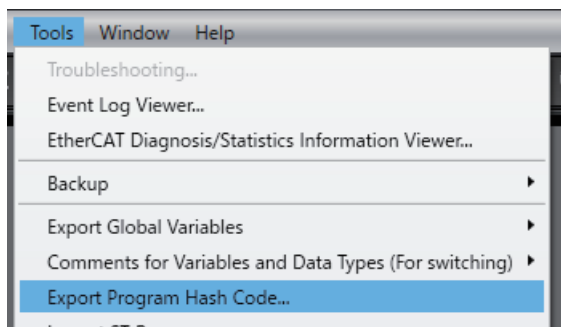

The **Export Program Hash Code** Dialog Box is displayed.

- 2 Enter the file name, and then click the **Save** Button.
The CSV file is saved.

● Program Hash Code File Format

The file format of the program hash code that this function outputs is as follows.

File format: CSV (Comma-separated values)

Data format:

Sysmac Studio Program Hash Code				
Created	2022-10-27T14:00:00+09:00			
Device Name	new_Controller_0			
Model Name	NJ501-1500			
Project Unit Version	Ver.1.80			
Program Hash Code	16#476790F6	16#4A7F7DEF	16#3596B3F3	16#B55E7865

The items are described in the following table.

Item	Description			
Created	File output date and time			
Device Name	Controller name			
Model Name	Model name of the Controller			
Project Unit Version	Project unit version of the Controller			
Program Hash Code	Code1	Code2	Code3	Code4

Code1 to Code4 are the same values as those of the output variables (Code1 to Code4) of the GetPrgHashCode instruction.



Precautions for Correct Use

- The program hash code may vary depending on program, Controller model, and project unit version.
- If using a program hash code to detect changes in the program, export the program hash code after changing the project unit version and check its values.
- If the program hash code is unintentionally changed, use the synchronization and detailed comparison functions to check the change.



Version Information

To use this function, one of the following CPU Units and Sysmac Studio versions are required.

Sysmac Studio version 1.50 or higher

Model	Project unit version
NJ101-□□□□	Version 1.50 or later
NJ301-□□□□	Version 1.50 or later
NJ501-□□□□	Version 1.50 or later
NX102-□□□□	Version 1.50 or later
NX1P2-□□□□DT, NX1P2-□□□□DT1	Version 1.50 or later
NX701-□□□□	Version 1.32 or later

Sysmac Studio version 1.54 or higher

Model	Project unit version
NX502-1□00	Version 1.60 or later

8-19 Exporting Global Variables

You can export global variables in a format that can be used in the following Support Software.

- Network Configurator
- CX-Designer

8-19-1 Exporting Global Variables for the Network Configurator

You can export global variables to a CSV file that the Network Configurator can read.

● Exported Variables

All global variables that are published to the network as inputs or outputs.

● Export Procedure

- 1 When there are variables to export, select **Export Global Variables – Network Configurator** from the **Tools** Menu
The Save Dialog Box is displayed.
- 2 Enter the file name, and then click the **Save** Button.
The CSV file is saved.



Precautions for Correct Use

You cannot export global variables if the variable names are the same as address expressions for OMRON CJ-series PLCs, as shown in the following table.

Memory area	CIO Area	DM Area	Work Area	Holding Area	EM Area
Examples	1234	D1234	W12	H123	ED_1234 or E17_8

8-19-2 Exporting Global Variables for the CX-Designer

You can copy the global variables to the clipboard in a format that the CX-Designer can read.

● Exported Variables

All global variables that are published to the network as inputs, outputs, or publish only variables.

● Export Procedure

- 1 When there are variables to export, select **Export Global Variables – CX-Designer** from the **Tools** Menu
The global variables are copied to the clipboard.



Precautions for Correct Use

Variables with the following data types cannot be exported: *STRING* arrays and *ENUM*.

8-20 Importing ST Programs

You can import XML files that were output from the Simulink® PLC Coder™ from MathWorks® Inc. for the OMRON Sysmac Studio.

● Imported Data

You can import programs, functions, function blocks, data types, and global variables.

● Importing Procedure

- 1 Select **Import ST Program** from the **Tools** Menu.

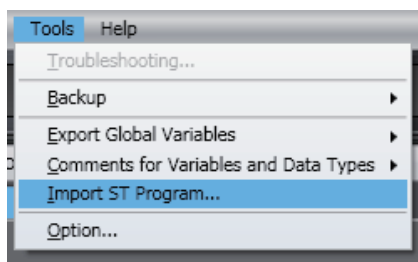

A Select File Dialog Box is displayed.

- 2 Select the XML file to import, and then click the **Open** Button.

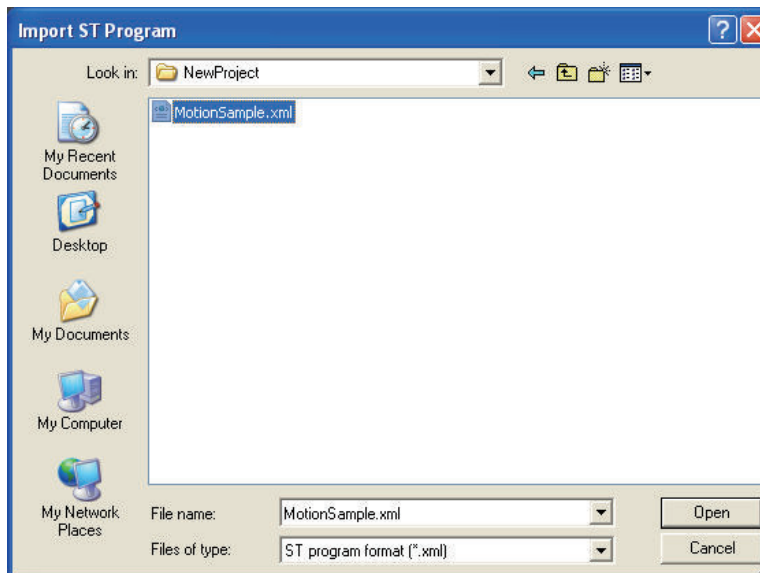

The data is imported and the programs, functions, function blocks, data types, and global variables in the XML file are added to the project.

The items that are added by importing the data are displayed in the Output Tab Page.



Additional Information

You can create code for the OMRON Sysmac Studio with Simulink PLC Coder revision R2013a or higher.

For information on the Simulink PLC Coder, refer to the *Simulink PLC Coder User's Guide* from MathWorks.

8-21 Importing IEC 61131-10 XML Files

This function imports XML files that are defined in IEC 61131-10. These XML files contain data types, global variables, and POU programming-related data based on the ladder diagrams or ST that are defined in IEC 61131-3. You can read programming data that was created with software other than the Sysmac Studio into the Sysmac Studio.

An example of writing XML is installed by default in the following folder.

To check the data supported by this function, refer to the XML schema in the same folder.

● Sysmac Studio (32 bit)

For 32-bit OS:

C:\Program Files\OMRON\Sysmac Studio\Sample\IEC 61131-10 XML\Controller

For 64-bit OS:

C:\Program Files (x86)\OMRON\Sysmac Studio\Sample\IEC 61131-10 XML\Controller

● Sysmac Studio (64 bit)

C:\Program Files\OMRON\Sysmac Studio\Sample\IEC 61131-10 XML\Controller

✓ Version Information

This function can be used in projects for the NX102 CPU Unit with unit version 1.31 or later, NX502 CPU Unit version 1.60, and the NJ/NX/NY-series CPU Unit with unit version 1.19 or later.

8-21-1 Importing Data

● Imported Data

You can import programs, functions, function blocks, data types, and global variables.

● Importing Procedure

- 1 Select **IEC 61131-10 XML - Import** from the **Tools** Menu.
The IEC 61131-10 XML Import Dialog Box is displayed.

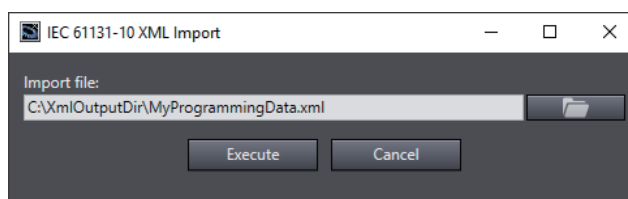

- 2 Click the file selection dialog box button.

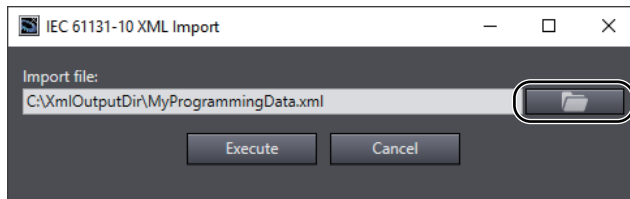

The Select File Dialog Box is displayed.

3 In the Select File Dialog Box, select the XML file to import, and then click the **Open** Button. The screen return to the IEC 61131-10 XML Import Dialog Box, in which the path to the file that you selected in the Select File Dialog Box is displayed as the import file.

4 Click the **Execute** Button.

The data is imported and the programs, functions, function blocks, data types, and global variables in the XML file are added to the project.

If the project already has any data type, global variable, program, function, and/or function block with the same name but with a different content, the **Compare before importing** Dialog Box is displayed.

For details on the **Compare before importing** Dialog Box, refer to *8-21-2 Compare before Importing* on page 8-152.



Precautions for Correct Use

Check the operation of the imported program for proper execution before you use it for actual operation.

8-21-2 Compare before Importing

If program data exists in the project before import, and there are variables or data types with the same name and different attributes in the import target, or if there are different ladder diagrams or ST programs, the **Compare before importing** Dialog Box is displayed to confirm whether you want to overwrite the data.

Compare before Importing Dialog Box

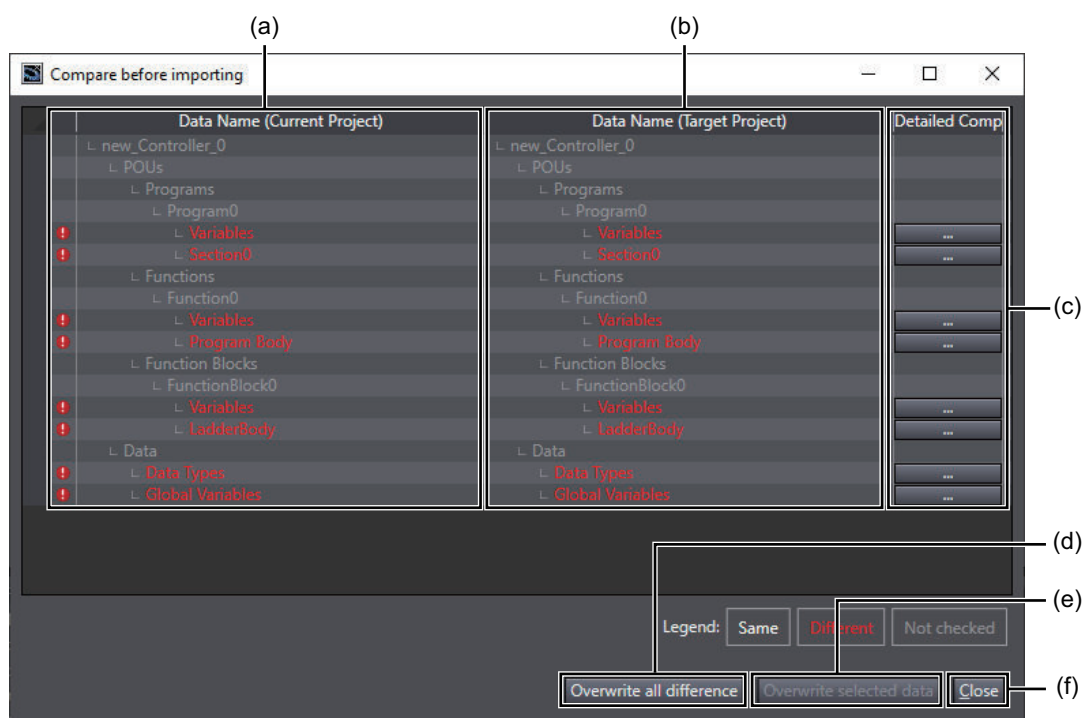

	Item	Description
(a)	Data before importing	Displays data before importing if any difference is detected. The lines which contain any data differences are displayed in red.
(b)	Data to be imported	Displays data to be imported if any difference is detected.
(c)	Detailed Comparison Button	Displays the Detailed Comparison Window that contains difference details.
(d)	Overwrite all difference Button	Overwrites all lines that contain any differences with the data to be imported.
(e)	Overwrite selected data Button	Overwrites the selected line with the data to be imported.
(f)	Close Button	Closes the dialog box.

Detailed Comparison Window

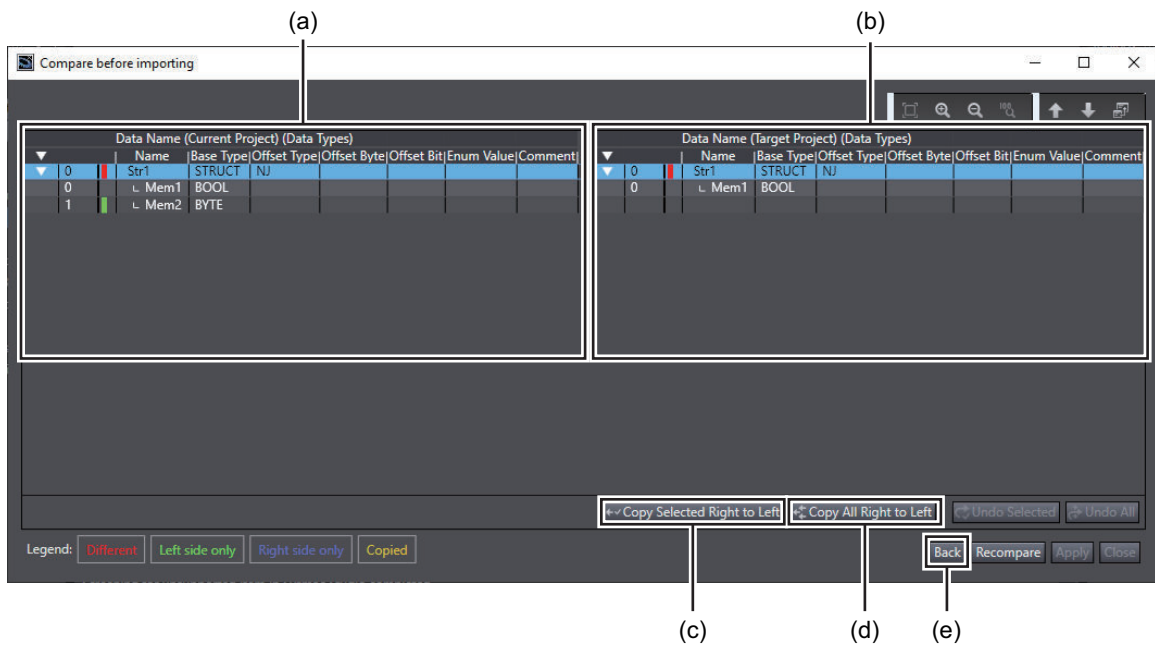

	Item	Description
(a)	Data before importing	Displays data before importing. The lines which contain any data differences are displayed in red.
(b)	Data to be imported	Displays data to be imported.
(c)	Copy Selected Right to Left Button	Overwrites the existing data in the selected line with the data to be imported.
(d)	Copy All Right to Left Button	Overwrites all existing data that contains any differences with the data to be imported.
(e)	Back Button	Returns to the Compare before importing Dialog Box.

8-22 Importing IEC-62714 AutomationML Files

You can import the controller configuration and device variables from electrical CAD drawings that you created with EPLAN Electric P8 into the Sysmac Studio via an AutomationML file (hereinafter called the AML file). For details on the setting procedures in EPLAN Electric P8, which are required to import the data to the Sysmac Studio, refer to the *Sysmac Studio Electrical CAD Connector Function Practices Guide for AutomationML Import (EPLAN Electric P8) (Cat. No. P156)*.

The sample files are installed by default in the following folder.

Refer to them when checking various setting data if you design electrical systems using EPLAN Electric P8 and then import the controller configuration and device variables to the Sysmac Studio via an AML file.

● For Sysmac Studio (32-bit)

For 32-bit OS:

C:\Program Files\OMRON\Sysmac Studio\Sample\IEC 62714 AutomationML

For 64-bit OS:

C:\Program Files (x86)\OMRON\Sysmac Studio\Sample\IEC 62714 AutomationML

● For Sysmac Studio (64-bit)

C:\Program Files\OMRON\Sysmac Studio\Sample\IEC 62714 AutomationML

No.	File name	Description
(a)	SampleProject.zw1	This file is an EPLAN Electric P8 sample project containing electrical CAD drawings.
(b)	SampleProject.aml	This AML file will be generated by opening the sample project (a) in EPLAN Electric P8 and then exporting PLC data.



Version Information

This function can be used with the following CPU Units.

Model	Project unit version
NJ101-□□00	Version 1.47 or later
NJ301-1□00	Version 1.47 or later
NJ501-1□00	Version 1.48 or later
NX102-□□00, NX102-□□20	Version 1.48 or later
NX1P2-□□□□DT, NX1P2-□□□□DT1	Version 1.47 or later
NX502-1□00	Version 1.60 or later
NX701-1□00, NX701-1□20	Version 1.28 or later

Refer to the *Sysmac Studio Electrical CAD Connector Function Practices Guide for AutomationML Import (EPLAN Electric P8) (Cat. No. P156)* for the supported models of Units that are connected to the CPU Unit.

8-22-1 Importing Data

- 1 Select **IEC 62714 AutomationML – Import** from the **Tools** Menu.
A project save confirmation message is displayed.

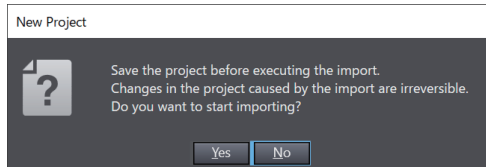

Click the **Yes** Button. The **IEC 62714 AutomationML Import** Dialog Box is displayed.

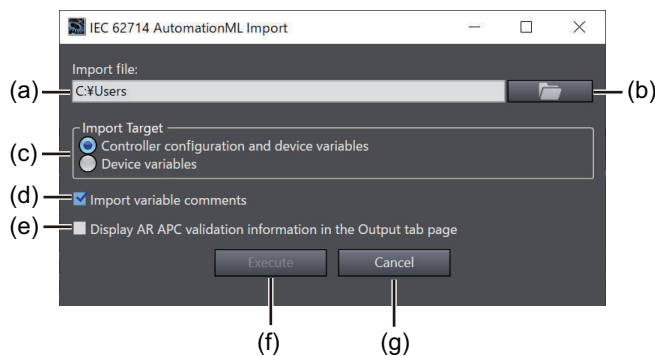

No.	Item	Description	
(a)	Import file	Displays the path to the AML file to import.	
(b)	File selection dialog box button	Displays a dialog box for specifying the AML file to import.	
(c)	Import Target	Controller configuration and device variables	Imports the controller configuration and the device variables associated with the I/O ports in the configuration.
		Device variables	Imports the device variables associated with the I/O ports in the project's controller configuration.
(d)	Import variable comments Check Box	Includes device variable comments in the import target when selected.	
(e)	Display AR APC validation information in the Output tab page Check Box	Displays AR APC (Application Recommendation Automation Project Configuration) validation information in the Output Tab Page when selected.	
(f)	Execute Button	Imports the AML file.	
(g)	Cancel Button	Closes the dialog box with the settings for the AML file import discarded.	

- 2 Click the file selection dialog box button.

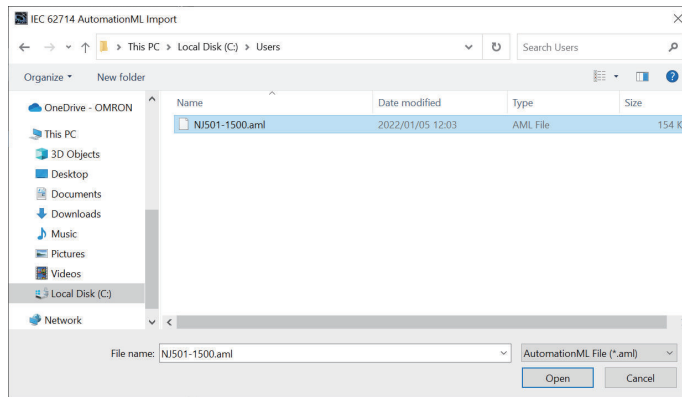

The file selection dialog box is displayed.

3 In the file selection dialog box, select the AML file to import, and then click the **Open** Button. The screen returns to the **IEC 62714 AutomationML Import** Dialog Box, in which the path to the file that you selected in the file selection dialog box is displayed as **Import file**.

4 Set the import conditions and click the **Execute** Button.

When you select **Controller configuration and device variables** for **Import Target** in the **IEC 62714 AutomationML Import** Dialog Box, the **IEC 62714 AutomationML Import: Controller configuration** Dialog Box will show results of comparison between controller configurations in an AML file and a project.

Refer to *8-22-2 Comparison Results of Controller Configurations* on page 8-159 for details on the items displayed in the **IEC 62714 AutomationML Import: Controller configuration** Dialog Box.

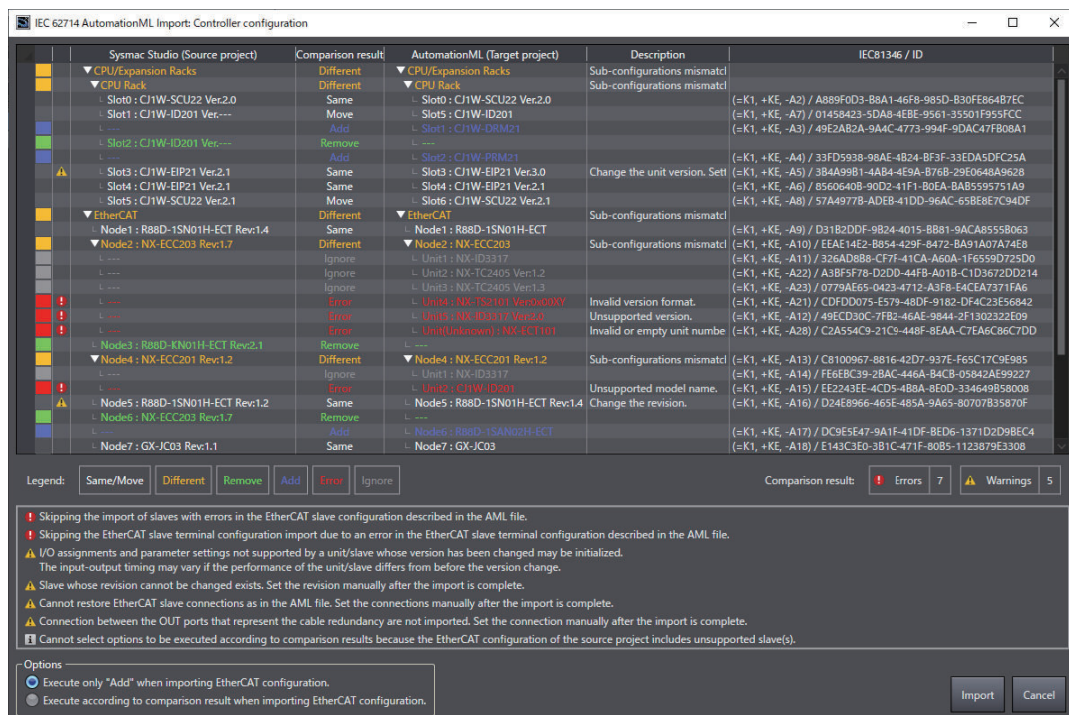

5 In **Options**, select the import option and then click the **Import** Button. The import of the controller configuration and device variables is executed.

If the project already has global variables with the same names but different attributes, the **Resolve Conflicts between Global Variable Table and Imported Data** Dialog Box appears so that you can resolve the conflicts between the variables.

For details on the **Resolve Conflicts between Global Variable Table and Imported Data** Dialog Box, refer to *8-22-3 Resolving Conflicts between Device Variables* on page 8-161.

- 6** When a message that shows the completion of import is displayed, click the **OK** Button.

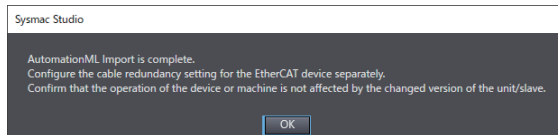

The results of the import are displayed in the Output Tab Page.

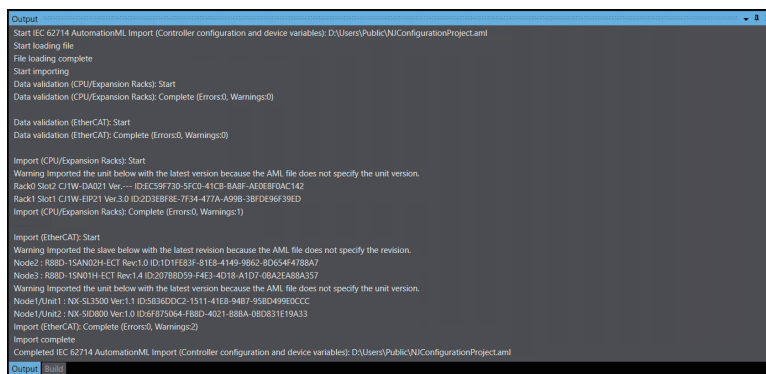

Precautions for Correct Use

Check the system operation with the imported device variables carefully before the actual operation.



Additional Information

Global variables imported from an AML file may have the comment *Spare*. Please delete the comment in the global variable table if it is unnecessary.

This phenomenon will occur if you set the symbol address (device variable), but do not set the function text (device variable comment) or leave the column blank, in an EPLAN Electric P8 project before exporting the AML file.

8-22-2 Comparison Results of Controller Configurations

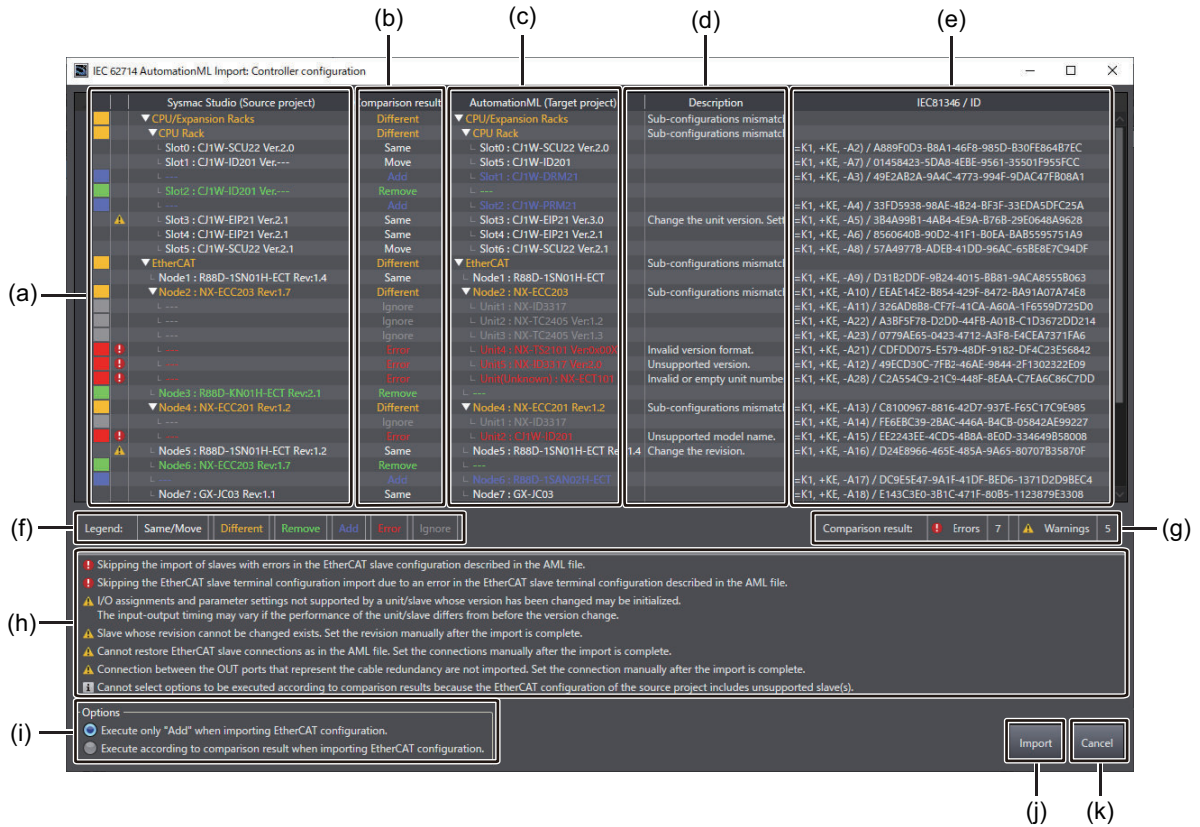

Item	Description	
(a)	Sysmac Studio (Source project) Displays the controller configuration included in the current project. *1	
(b)	Comparison result	Displays the comparison results.
	Same	<p>EtherCAT Slaves</p> <p>The source and the target are the same. It is judged as Same when the model and the node address are the same. Even if the slave revision differs between the source and the target, it is judged as Same. If import is executed in this state, the slave revision of the target will be reflected in the source.</p> <p>Other than the above</p> <p>The source and the target are the same. It is judged as Same when the unit model is the same in the source and in the target. Even if the unit version differs between the source and the target, it is judged as Same. If import is executed in this state, the unit version of the target will be reflected in the source.</p>
	Move	The unit position differs between the source and the target. During import, the unit position of the target will be reflected in the source.
	Different	There is a difference in subordinate configurations to the line.

		Item	Description
	Remove	EtherCAT Slaves	Some slaves in the source do not exist in the target. The slaves in the source project will be removed during import according to the setting of Options .
		Other than the above	Some units in the source do not exist in the target. During import, the units in the source of the comparison will be removed.
	Add	Some units or slaves exist only in the target. During import, the units or slaves in the target will be added to the source with the default settings applied.	
	Error	There is an error in the controller configuration in the target. If there is an error, the device in the target indicated in the line will not be imported.	
	Ignore	EtherCAT Slaves	If some slaves that are not supported by the electrical CAD connector function are registered in the source project, the settings before execution of import will be inherited without comparison processing.
Other than the above		If an error in a target unit prevents comparison processing for subsequent units, the comparison result is Ignore . If there is even one error in a unit in the target, the unit configuration in the target will not be imported.	
(c)	AutomationML (Target project)	Displays the controller configuration included in an AML file. *1	
(d)	Description	Displays a description of the (b) Comparison result .	
(e)	IEC81346/ID	Displays the values of PlantDesignation IEC, LocationIdentifier IEC, and ProductDesignation IEC defined in IEC81346 and the IDs in the AML file. Refer to the <i>Sysmac Studio Electrical CAD Connector Function Practices Guide for AutomationML Import (EPLAN Electric P8) (Cat. No. P156)</i> for details on each description.	
(f)	Legend	Displays the legend for (b) Comparison result .	
(g)	Comparison result	Displays the numbers of errors and warnings.	
(h)	Error, warning, and information	Displays processing information and warnings during the execution of import.	
(i)	Options	Select your option for how to process the EtherCAT configuration when importing the AML file.	
	Execute only <i>Add</i> when importing EtherCAT configuration.	Executes only <i>Add</i> when importing an EtherCAT configuration. For slaves with a comparison result of <i>Remove</i> , the slaves in the source will not be removed.	
	Execute according to comparison result when importing EtherCAT configuration.	Executes according to comparison result when importing an EtherCAT configuration. For slaves with a comparison result of <i>Remove</i> , the slaves in the source will be removed to match the configuration in the target.	
(j)	Import	Imports the AML file with the dialog box closed.	
(k)	Cancel	Cancels the import of the AML file with the dialog box closed.	

*1. In the controller configuration items to be compared, EtherCAT slaves are displayed in ascending order of node address, regardless of the network configuration of a source or target project.

8-22-3 Resolving Conflicts between Device Variables

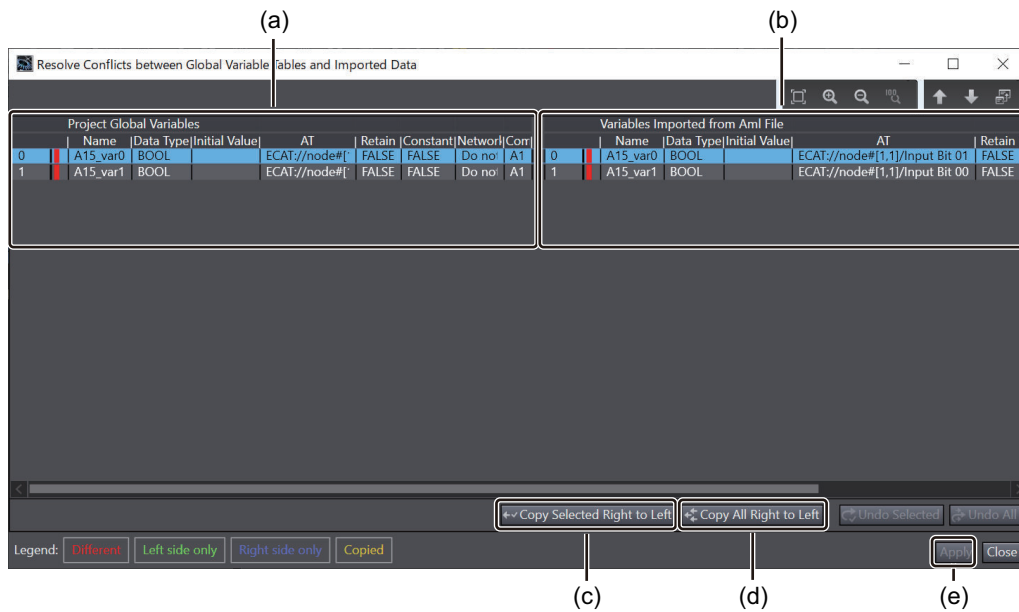

If the project has global variables with the same names but different attributes when importing an AML file, the **Resolve Conflicts between Global Variable Table and Imported Data** Dialog Box appears so that you can resolve the conflicts between the variables.

No.	Item	Description
(a)	Project Global Variables	Displays global variables in the project before import. The lines containing any difference in data are displayed in red.
(b)	Variables Imported from AML File	Displays variables imported from the AML file.
(c)	Copy Selected Right to Left Button	Copies global variables from the selected AML file to the project global variables.
(d)	Copy All Right to Left Button	Copies all conflicting global variables from the AML file to the project global variables.
(e)	Apply Button	Applies any changes to the current project.

8-23 Importing Motor Sizing Tool Results

You can import the results of the Motor sizing tool.

● Imported Data

You can import EtherCAT configurations and settings, Drive settings, axis settings, and axes group settings.

● Importing Procedure

- 1 Select **Import Motor sizing tool Results** from the **Tools** Menu.

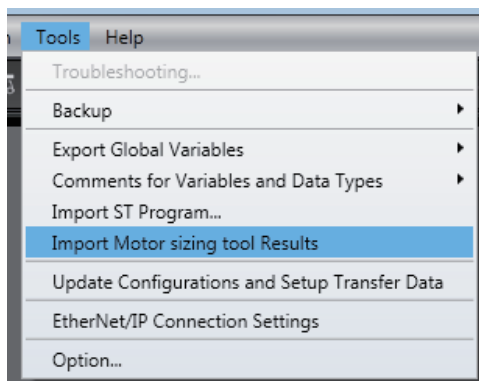

An import confirmation dialog box is displayed.

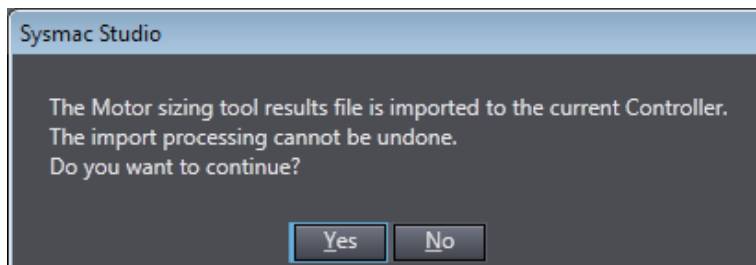

- 2 Click the **Yes** Button.

The file selection dialog box is displayed.

- 3 Select the XML file to import, and then click the **Open** Button.

If the currently selected Controller does not match the Controller in the results of the Motor sizing tool, a dialog box will appear to confirm whether to continue the import operation.

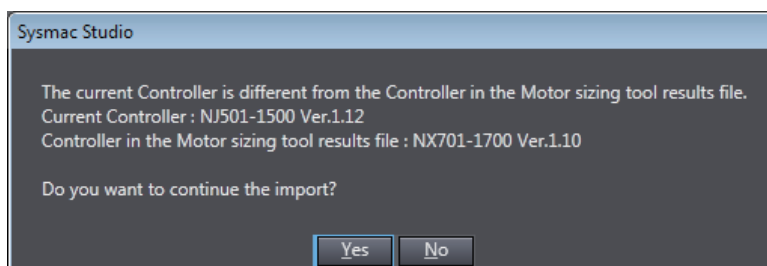

4 Click the **Yes** Button.

The results are imported and the Drive, axes, and axes groups are added to the project. When the import operation is completed, a completion message box is displayed.

The items added by the import operation and error information are displayed in the Output Tab Page.

**Additional Information**

Refer to the *Motor Sizing Tool Startup Guide (Cat. No. 1820)* for details on the Motor sizing tool.

8-24 Updating the Configurations and Setup Transfer Data

You can update the Configurations and Setup data that is transferred to the Controller.

You can do this to apply the contents of an ESI file to the transfer data after you update the ESI file on the EtherCAT Tab Page.

When you update the Configurations and Setup transfer data, all of the Configurations and Setup data is transferred when you execute synchronization.

To update the Configurations and Setup transfer data, select **Update Configurations and Setup Transfer Data** from the **Tools** Menu.



Additional Information

If you edit the contents of the Configurations and Setup, the edited locations are transferred when you execute synchronization. It is therefore not necessary to use this menu command.

8-25 EtherNet/IP Connection Settings

You can make settings for EtherNet/IP connections.

EtherNet/IP connections (i.e., tag data links) are used for cyclic exchange of data between Controllers or between Controllers and other devices on an EtherNet/IP network.

Refer to the *NJ/NX-series CPU Unit Built-in EtherNet/IP Port User's Manual (Cat. No. W506)* or *NY-series Industrial Panel PC / Industrial Box PC Built-in EtherNet/IP Port User's Manual (Cat. No. W563)* for details on setting EtherNet/IP connections (i.e., tag data links).

To access the EtherNet/IP connection settings, select **EtherNet/IP Connection Settings** from the **Tools** Menu.



Precautions for Correct Use

If you export a project that includes EtherNet/IP connection settings, select the smc2/csm2 file format. EtherNet/IP connection settings are not saved in project files exported to the smc/csm file format.

8-26 Sysmac Studio Option Settings

8-26-1 Option Settings

You can set the color theme for the Sysmac Studio, you can hide or display variable comments, and you can change the settings for program checks.

- 1 Select **Option** from the **Tools** Menu.

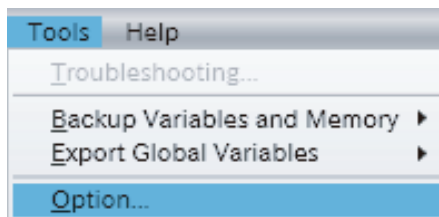

An **Option** Dialog Box is displayed.

- 2 Change the settings and then click the **OK** Button. The changes are applied. A message is displayed if it is necessary to restart the Sysmac Studio. If a message is displayed, restart the Sysmac Studio to apply the changes.

The option setting are listed in the following table.

Category	Option	Set value	Description
Color theme	Color theme	<ul style="list-style-type: none"> • Gray (default) • White 	This option changes the overall color theme of the Sysmac Studio.
Startup	Fast Startup	Enable Fast Startup	Sysmac Studio becomes resident so that it can start immediately.
Project Settings	Default Author Name	Enable Default Author Name	You can set the default value of the author name that is displayed as a property of the project or POU. You can set up to 127 characters. In the default setting, the user name that you entered when you logged on-to Windows is displayed.
	Default Communications Settings	Response Monitor Time (1-3600 sec)	You can set a default value for the response monitoring time for communications with the Controller.

Category	Option	Set value	Description
Window	Edit Pane	Maximum number of tab pages in Edit Pane	You can set the number of tab pages in the Edit Pane and floating edit windows that can be displayed at a time.
		When the maximum number of tab pages in the Edit Pane is exceeded, close the tab page that has not become active for the longest time	If the maximum number of tab pages in the Edit Pane and floating edit windows is exceeded when you open a new tab page, the tab page that has not been used for the longest time is closed automatically. Note that the following tab pages are excluded from this setting. <ul style="list-style-type: none"> • MC Test Run Tab Page • Diagnosis/Statistics Information Tab Page • Drive Settings Tab Pages (Auto Tuning, Test Run, and Damping Control) • Trend Monitor Tab Page for ZW-series Displacement Sensors
	Window layout	Save/restore the window layout as the project-specific setting for each	The window layout is saved or restored for each project.
		Save/restore the window layout as the common setting with all projects	The window layout is saved or restored as common for all projects.*1
Ladder Editor	Local variable table layout	Top	Place the local variable table at the top of the Ladder Editor.
		Bottom	Place the local variable table at the bottom of the Ladder Editor.
		Left	Place the local variable table on the left side of the Ladder Editor.
		Right	Place the local variable table on the right side of the Ladder Editor.

Category	Option	Set value	Description
	Rung display	Align right bar	The right bus bars of the rungs are aligned according to the width specified with Display width of rungs [pixel] . If a rung cannot be displayed within the specified width due to so many circuit parts, all circuit parts in the rung are displayed in the minimum displayable width.
		Display width of rungs [pixel]	When you align the right bus bars, specify the rung width to 200 to 2,000 pixels. You can use the Fit to the Edit Pane Width Button to set the rung width to the width of the Ladder Editor that is currently displayed. The Fit to the Edit Pane Width Button is enabled when you open the Option Dialog Box while the Ladder Editor is displayed.
Display width of variables		Fit to variable name	The variable name for any ladder diagram object is displayed on one line.
		Specify the max width	Variable names are displayed within the specified maximum width. The width is set in pixels on a slider.* ²
		Specify the fixed width	Variable names are displayed within the specified fixed width. The width is set in pixels on a slider.* ²
		When not fit in the specified width	If you specify the maximum width or a fixed width, variable names that do not fit in the specified width are left-aligned, right-aligned, or wrapped to multiple lines.* ³

Category	Option	Set value	Description
	Ladder Editor Guide	Show Ladder Editor Guide	When this check box is selected, you can show or hide Ladder Editor Guide in the Ladder Editor. When this check box is not selected, Ladder Editor Guide is always hidden. Select this check box and enable Show Guide in the Ladder Editor to display Ladder Editor Guide.
		Display size	Specify the display size of Ladder Editor Guide.
	In-Out variable sort order of Function/Function Block	Follow the definition order of the variable table of Function/Function Block	When a function or function block is called in a Ladder Editor, the display order of input variables, output variables and in-out variables follows the definition order in the variable table. If you set this item, the display of the function or function block in the Ladder Editor may be expanded in the vertical direction. If you do not set this item, output variables are abbreviated in the display.

Category	Option	Set value	Description
	Variable Comment	Show comment	This option allows you to display or hide variable comments for ladder diagram objects.
		Number of lines ^{*3}	You can set the number of lines to use to display variable comments. (1 to 5 lines)
		When a comment does not fit in the display area	You can set the part of comment omitted from the display when a variable comment does not fit in the display area. The beginning, middle, or end part of the comment can be omitted. The omitted part is displayed with ellipsis (...).
		Automatic display of comment editing window <ul style="list-style-type: none"> • Automatically display after entering a variable name • Automatically display only at registering variables • Do not display automatically 	Select the display timing of the comment editing window.
Element Comment	Show comment	This option allows you to show or hide element comments for ladder diagram objects.	
	Specify number of lines	You can specify the number of lines to display between one to five.	
	Show whole content	The whole content of element comments is shown.	

Category	Option	Set value	Description
	Color Selection	Focus background color Rung comments Jump labels Global variables Element comments Variable comments Online power flow Unmonitored power flow Monitored present values Rung comment background color AT specification variable background color Network variable (Publish Only) background color Network variable (Input) background color Network variable (Output) background color Ladder background color (offline) Ladder background color (online)	You can change the colors of the elements in the Ladder Editor.
	Present Value Display	Display present values of array index variables	You can set whether to display the present values of variables that are used as subscripts for array variables, structure array variables, and array elements or members of union array variables.
	Auto Variable Registration	Select local or global variable and register it.	You can set whether to display the dialog box to select the variable table in which to register new variable names that are entered in the Ladder Editor. The setting is valid only when the Sysmac Studio is offline.
		Specify the data type	You can set whether to display a dialog box to enter the data type when the data type cannot be determined when a new variable name is entered on the Ladder Editor.

Category	Option	Set value	Description
ST Editor	Local variable table layout	Top	Place the local variable table at the top of the ST Editor.
		Bottom	Place the local variable table at the bottom of the ST Editor.
		Left	Place the local variable table on the left side of the ST Editor.
		Right	Place the local variable table on the right side of the ST Editor.
	Auto Complete	Enable Auto Complete (default: enabled)	A list of candidates is automatically displayed when entering instructions or variables.
	Font Setting	Font	You can change the font to use to display programs in the ST Editor. A preview of the selected font is displayed in the preview box.
	Color Selection	Comments Global variables ST background color (off-line) ST background color (on-line)	You can change the colors of the elements in the ST Editor.
	Present Value Display	Display present values of array index variables	You can set whether to display the present values of variables that are used as subscripts for array variables, structure array variables, and array elements or members of union array variables.
	Upon clicking variable registration mark	Select local or global variable and register it.	You can set whether to display the dialog box to select the registered variable table when the variable registration mark is clicked in the ST Editor. The setting is valid only when the Sysmac Studio is offline.
		Specify the data type	You can set whether to display the dialog box to enter data types when the variable registration mark is clicked in the ST Editor.
HMI Code Editor	You can make settings for the NA-series PT Code Editor. Refer to the <i>NA-series Programmable Terminal Software User's Manual (Cat. No. V118)</i> for details.		
HMI Page Editor	You can make settings for the NA-series PT Page Editor. Refer to the <i>NA-series Programmable Terminal Software User's Manual (Cat. No. V118)</i> for details.		

Category	Option	Set value	Description
Program Check/ Build	Ladder Program Check	Display the following warnings in ladder program checks <ul style="list-style-type: none"> • Duplicate use of an output • Duplicate use of a function block instance • No reference to an internal output from others or no value writing to an internal input from others 	You can select whether to display specific warnings for ladder diagram program checks.
	Variable Check	Display a warning level when network variables are not registered in the settings for exclusive control of variables in tasks	Check for network variables that are not registered in the settings for exclusive control of network-published variables in tasks.
	Program Check/ Build	Run automatically	You can select whether to automatically check and build a program when you change program data.
	Program check	Detect an error when an in-out variable is passed to specific instruction argument.*4	Causes the program checker to detect an error when an in-out variable is passed to a specific instruction argument in a program.
Variables	Initial Value Setting Dialog	Array layout selectable Vertical layout for arrays	You can change the display format of the dialog box that is used to set the initial values of structure variables, array variables, and structure array variables.
	When changing a variable name on the variable table	Do not change the variable name used in programs Change the variable name used in programs	Set whether to change the same variable name in other locations when you change a variable name. When you select the <i>Change the variable name used in programs</i> Check Box, the variable names used in the programs and external variables will be changed at the same time you change the variable name in the variable table.
Comments for Variable and Data Types	Select comment	Enable multi-comment selection Comment 1 (default) Comment 2	You can switch the variable comments and data type comments.
	External variable comments in Ladder/ST Editors	Use global variable comment	The comments for the global variables are displayed instead of the comments for the corresponding external variables.

Category	Option	Set value	Description
Parameter Editor (Drive)	Online	Automatically transfer updated parameter(s) to drive	Parameters that are changed during online with the Drive are immediately transferred to the drive.
		Confirm transfer operation	When parameters are transferred to the Drive, a confirmation message is displayed.
		Allow downloading of invalid values	Parameters are transferred even when they are out of range.
	Display	Show reserved parameters	Parameters that are reserved by the system are displayed.
		Show all drive parameters	All parameters are displayed.
Synchronization	Comparison	Enable algorithm check for programs	You can enable or disable checking the program algorithm when you use synchronization to compare the data between the project and Controller.*5
Automation Playback	Configure the automation playback settings. Refer to the <i>NX-series CPU Unit Automation Playback User's Manual (Cat. No. W639)</i> for details.		
Safety	Configure the Safety CPU Unit settings. Refer to the <i>NX-series Safety Control Unit User's Manual (Cat. No. Z930)</i> for details.		

- *1. For library projects and IAG projects, a window layout is saved or restored to their own common templates respectively.
- *2. You can set between 50 and 500 pixels. The distance between the left edge of the Ladder Editor Pane and the left bus bar is 50 pixels. Use it as a guide.
- *3. Only one line is always displayed for the variables that are allocated to parameters in functions and function blocks and for the comments for the variables.
- *4. This option is displayed only for Sysmac Studio version 1.02. For details, refer to the *NJ/NX-series Instructions Reference Manual (Cat. No. W502)*.
- *5. Rung comments, variable comments, element comments, configuration data, and setup data are not checked for differences.

8-26-2 Exporting and Importing Option Settings

You can export the Sysmac Studio option settings and then import them into the Sysmac Studio on another computer.

Procedure to Export Option Settings

- 1** Select **Option** from the **Tools** Menu.
An **Option** Dialog Box is displayed.
- 2** Check the settings and then click the **Export** Button.

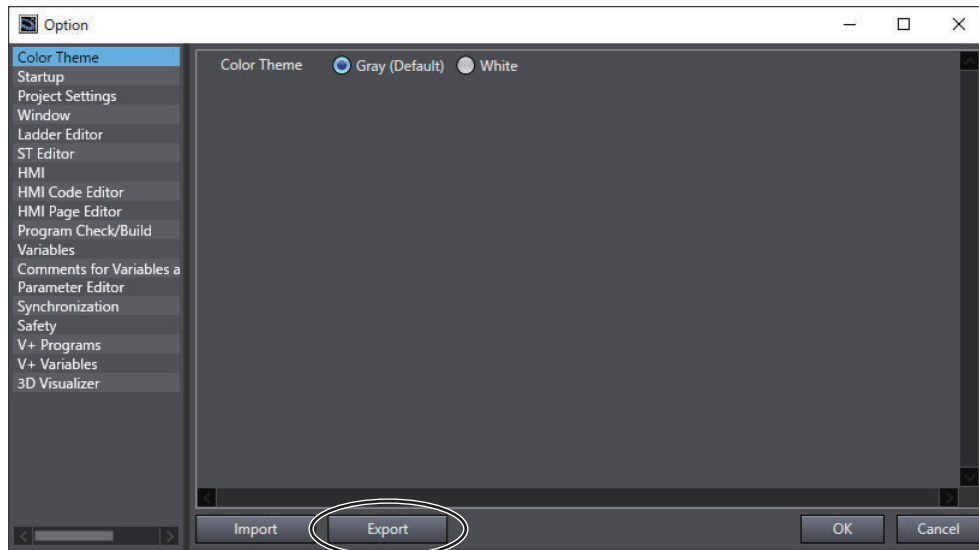

A file selection dialog box is displayed.

- 3 Enter the file name, and then click the **Save** Button.
When the export is completed, the following dialog box is displayed.

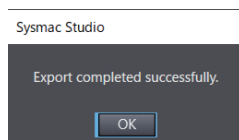

- 4 Click the **OK** Button.
The option settings are saved to an XML format file and the **Option** Dialog Box closes.



Precautions for Correct Use

Do not edit the exported Sysmac Studio option setting file. If you make any edits, you will not be able to import the file.

Procedure to Import Option Settings

- 1 Select **Option** from the **Tools** Menu.
An **Option** Dialog Box is displayed.
- 2 Check the settings and then click the **Import** Button.

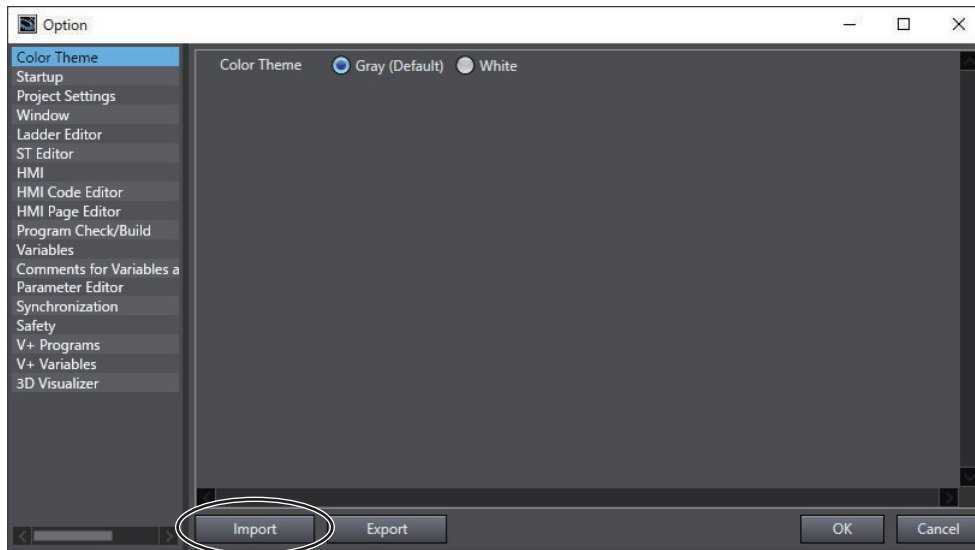

- 3** A confirmation message appears to confirm whether you want to overwrite the option settings. Click the **OK** Button.

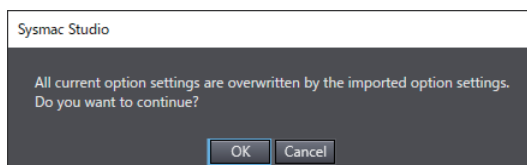

A file selection dialog box is displayed.

- 4** Select the XML file to import, and then click the **Open** Button. When the import operation is completed, the following completion message is displayed.

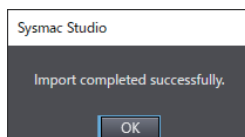

The **Option** Dialog Box closes with the contents of the XML file applied.

9

Reusing Programming

This section describes how to reuse the programs that you create with the Sysmac Studio.

9-1	Overview	9-2
9-2	Example of Reusing Device and Program Assets	9-4
9-2-1	Changing I/O Assignments.....	9-4
9-2-2	Deleting Device Options.....	9-5
9-2-3	Adding Device Options.....	9-6
9-3	Creating and Using Libraries	9-8
9-3-1	Creating a Library.....	9-8
9-3-2	Using a Library	9-12
9-4	Program Sharing in Derived Devices	9-17
9-4-1	Overview of Sharing Programs in Derived Devices	9-17
9-4-2	Procedure to Share a Program	9-18
9-4-3	Editing Shared Data	9-21
9-4-4	Changing a Sharing Relationship.....	9-23

9-1 Overview

The ability to reuse development assets is necessary to reduce development costs, shorten development time, and reduce maintenance costs for production facilities.

With previous PLCs, information was exchanged with I/O devices through addresses that were assigned to the hardwired devices. These addresses were used to write the program. As a result, changing the addresses for device changes involved complex procedures to obtain new addresses, move comments to new addresses, change addresses in the program, etc. This was inevitably accompanied by mistakes.

The relationship between hardware and software was strong and the function modules were large, so the affects of changes could not be absorbed by the modules.

With the NJ/NX/NY-series Controllers, information for hardwired I/O devices is handled in I/O devices that are defined within the system. The programs are created based on these I/O devices and the variables that are assigned to them by the user. Even if devices are changed, it is often not necessary to change the programs when the I/O devices that are defined within the system are changed, i.e., it is only necessary to change the variable assignments to I/O devices.

The hardware-software function modules separate the I/O devices and variables, and the affects of changes can be absorbed by the function modules.

This reduces the corrections that require complex procedures, which in turn reduces mistakes. Confirmation and correction work are also reduced to reduce the cost of development and development time.

Using Variable Programming to Reuse Programs

The Sysmac Studio provides an environment for programming with variables and POU (program organization units), including functions, function blocks, and programs. Variables are assigned to read external devices and I/O information in the user program.

Refer to *9-2 Example of Reusing Device and Program Assets* on page 9-4 for an example of applicable devices.

Creating Libraries to Reuse Programs

You can create libraries of functions, function blocks, and data types to reuse them as objects in other projects.

Refer to *9-3 Creating and Using Libraries* on page 9-8 for details on how to create and use libraries.

Sharing a Machine Project with EtherCAT Configuration

You can use the Enable/Disable EtherCAT Slave function on more than one machine with different EtherCAT slave configurations to share a machine project.

To do so, create a device project with the maximum number of EtherCAT slaves and enable or disable each EtherCAT slave by the program depending on the device configuration.

For details on the Enable/Disable EtherCAT Slave function, refer to the *NJ/NX-series CPU Unit Built-in EtherCAT Port User's Manual (Cat. No. W505)*.

Reusing Machines by Program Sharing

With the combination of Sysmac Studio version 1.20 or higher and Controllers with unit version 1.16 or later, you can share the same POUs, data types, and global variables among more than one Controllers in a project.

Suppose that you use a single project to manage Controllers for more than one device and share a program that provides common functions among the Controllers. Then, you can correct the program for only one Controller to apply the corrections to the programs for other Controllers.

Thus, you can reduce the time and effort to apply corrections that you made to a common program to all of the devices when you develop devices that are derived from a certain device.

Refer to *9-4 Program Sharing in Derived Devices* on page 9-17 for details.

9-2 Example of Reusing Device and Program Assets

This section describes how design assets would be reused in a typical system upgrade example. It compares the work required for traditional programming with fixed address as opposed to programming with variables with the Sysmac Studio.

9-2-1 Changing I/O Assignments

- In this example, the long-distance wiring from the I/O devices to Basic I/O Units is converted to a network device configuration that uses remote I/O slaves to save wiring and changing the I/O devices to remote I/O slaves to improve the maintainability of the system.

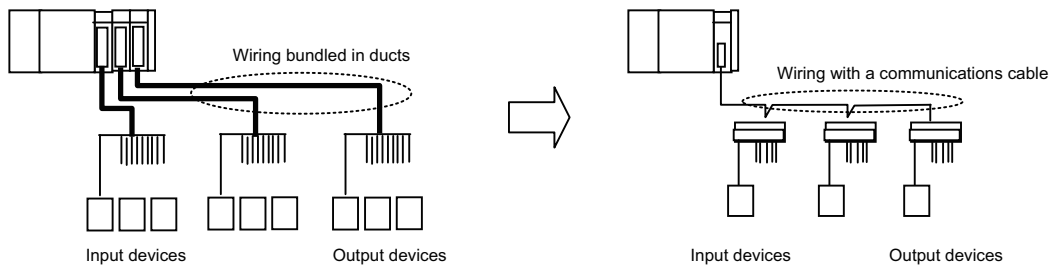

	Goal	Traditional programming	Programming with the Sysmac Studio
1	Checking the addresses assigned to the old devices	You must confirm the addresses and I/O comments assigned to the Basic I/O Units.	---
2	Checking the addresses assigned to the new devices	You must calculate the addresses assigned to the remote I/O slaves. Note If any of the calculated addresses are used as work bits, you must assign the work bits to new work bit addresses.	---
3	Replacing the addresses of the old devices with the addresses of the new devices.	You must move the I/O comment information for the previous addresses to the calculated new addresses. Note If any of the calculated addresses are used as work bits, you must move the I/O comments to the new work bit addresses.	You must delete the Basic I/O Units from the Unit configuration (variable assignments to I/O devices are cleared).
		You must replace the addresses of the old devices with the addresses of the new devices. Note If any of the calculated addresses are used as work bits, you must move the I/O comments to the new work bit addresses.	You must register the remote I/O slaves in the network configuration.
		You must register the remote I/O slaves in the network configuration.	You must assign variables to the I/O devices for remote I/O devices.
4	Changing the Unit Configuration in the project	You must delete the Basic I/O Units from the Unit Configuration.	---
		You must delete the old addresses from the variable table.	---

	Goal	Traditional programming	Programming with the Sysmac Studio
5	Building the devices and wiring	You must wire the I/O devices to the remote I/O device terminals according to the device configuration diagrams and wiring diagrams.	You must wire the I/O devices to the remote I/O device terminals according to the device configuration diagrams and wiring diagrams.
6	Checking wiring and addresses	You must visually confirm that wires are connected according to the wiring diagram using color codes and use a tester to check continuity.	You must visually confirm that wires are connected according to the wiring diagram using color codes and use a tester to check continuity.
		You must confirm that the output results to the new addresses are output to the remote I/O slave devices and that dummy inputs from I/O devices are reflected in the input words.	You must confirm that the output results to the variables are output to the remote I/O slave devices and that dummy inputs from I/O devices are reflected in the variables.
7	Debugging the programs	You must check for mistakes in address changes for device changes and make sure that operation timing is not affected.	You must make sure that operation timing is not affected.
8	Performing trial operation	You must perform trial operation of the device configuration and control programs after the changes are made.	You must perform trial operation of the device configuration and control programs after the changes are made.

9-2-2 Deleting Device Options

- In this example, part of the devices is removed from the system to reduce the production scale.

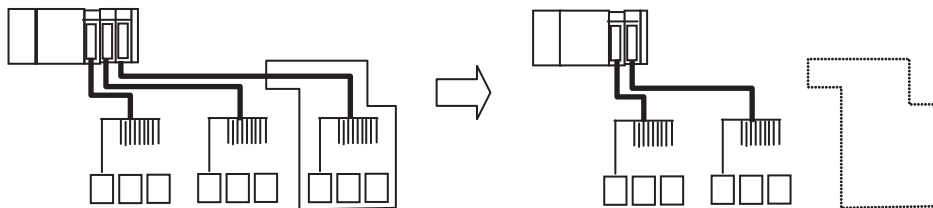

	Application	Traditional programming	Programming with the Sysmac Studio
1	Checking the addresses assigned to the devices to delete	You must check the addresses that are used by the devices to delete.	---
2	Checking the control programming for the devices to delete	You must check the programming that is used to control the devices to delete.	You must check the programs and program tasks that are used to control the devices to delete.
		You must check the programming that is used to monitor and interlock the devices to delete.	You must check the programs and program tasks that are used to monitor and interlock the devices to delete.
3	Changing the Unit Configuration in the project	You must delete the devices to delete from the Unit Configuration.	You must delete the devices to delete from the Unit configuration (variable assignments to I/O devices are cleared).

	Application	Traditional programming	Programming with the Sysmac Studio
4	Deleting the control programming for the unnecessary devices	You must delete the programming that is used to control the devices to delete.	You must delete the programs and program tasks that are used to control the devices to delete.
		You must correct the programming that is used to monitor and interlock the devices to delete.	You must correct the programs that are used to monitor and interlock the devices to delete.
		You must delete the addresses that are used by the devices to delete from the variable table.	---
5	Removing Units that were used for the devices to delete	You must remove the wiring to the external devices from the Units that were used for the devices to delete.	You must remove the wiring to the external devices from the Units that were used for the devices to delete.
		You must remove the external devices and the Units that were used for the devices to delete.	You must remove the external devices and the Units that were used for the devices to delete.
6	Debugging the programs	You must check for mistakes in program changes for the devices to delete and make sure that operation timing is not affected.	You must check for mistakes in program changes for the devices to delete and make sure that operation timing is not affected.
7	Performing trial operation	You must perform trial operation of the device configuration and control programs.	You must perform trial operation of the device configuration and control programs.

9-2-3 Adding Device Options

- In this example, part of the devices is expanded on the device copy line to increase the production scale.

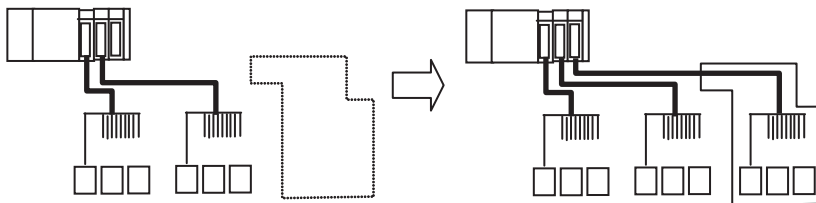

	Application	Traditional programming	Programming with the Sysmac Studio
1	Checking the addresses assigned to the devices to add	You must check the addresses to assign to the Units to use for the devices to add. Note If any of the assigned addresses are used as work bits, you must assign the work bits to unused work bits.	---
		You must add variables and comments for the work bits to use in the programming.	You must register the Units to use for the devices to add in the Unit Configuration.
		You must register the Units to use for the devices to add in the Unit Configuration.	You must register the variables to use in the programs.
		---	You must assign the variables to use to the I/O devices.

	Application	Traditional programming	Programming with the Sysmac Studio
2	Writing the control programming for the devices to add	You must write the control programming. Note If any of the assigned addresses are used as work bits, you must change the work bits to unused addresses.	You must write the control programming.
		You must understand the operation and affects of interlocks and improve the programming.	You must understand the operation and affects of interlocks and improve the programming.
3	Building the devices to add and wiring	You must add and wire devices according to the device configuration diagrams and wiring diagrams.	You must add and wire devices according to the device configuration diagrams and wiring diagrams.
4	Checking wiring and addresses	You must visually confirm that wires are connected according to the wiring diagram using color codes and use a tester to check continuity.	You must visually confirm that wires are connected according to the wiring diagram using color codes and use a tester to check continuity.
		You must confirm that the output results to the addresses are output to the devices and that inputs from I/O devices are reflected in the input words.	You must confirm that the output results to the variables are output to the devices and that inputs from I/O devices are reflected in the variables.
5	Debugging the programs	You must debug the programs.	You must debug the programs.
6	Performing trial operation	You must perform trial operation of the device configuration and control programs after the changes are made.	You must perform trial operation of the device configuration and control programs after the changes are made.

9-3 Creating and Using Libraries

You can create programs, functions, function block definitions, and data types in a library file to reuse them as objects in other projects.

Refer to the *NJ/NX-series CPU Unit Software User's Manual (Cat. No. W501)* or *NY-series Industrial Panel PC / Industrial Box PC Software User's Manual (Cat. No. W558)* for details on libraries.

9-3-1 Creating a Library

● Creating a Library

You can create programs, functions, function block definitions, and data types in a library file so that you can reuse them.

Procedure

Use the following procedure to create a library.

● Creating a Library Project

- 1 Create a new project on the Start page. Select a library project as the project type, select a Controller, and click the **Create** Button.
A project that can be used as a library is created.

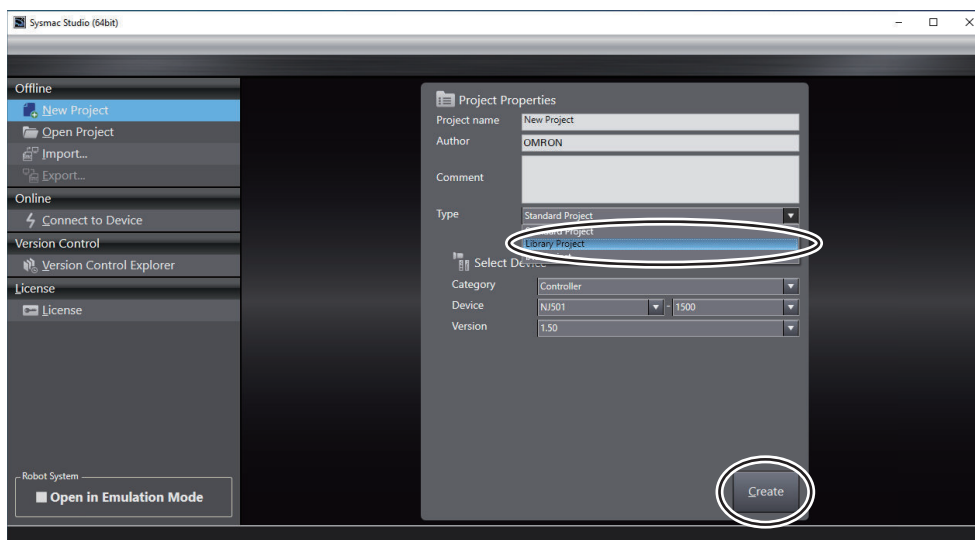

- 2 Create programs, functions, function block definitions, and data types using the standard programming procedures.



Additional Information

- You must select a Controller as the device for a library project.
- If the device for an existing project is set to a Controller, you can change the project type to a library project in the project property settings.
- We recommend that you use namespaces for the names of programs, functions, function block definitions, and data types that you create as library objects to prevent duplication of names in different programs. Refer to *4-4 Namespaces* on page 4-79 for information on namespaces.

● Setting Up a Library

The properties of the library are set before the library file is created.

- 1 Select **Library – Library Setting** from the **Project Menu**.
A Library Setting Dialog Box is displayed.

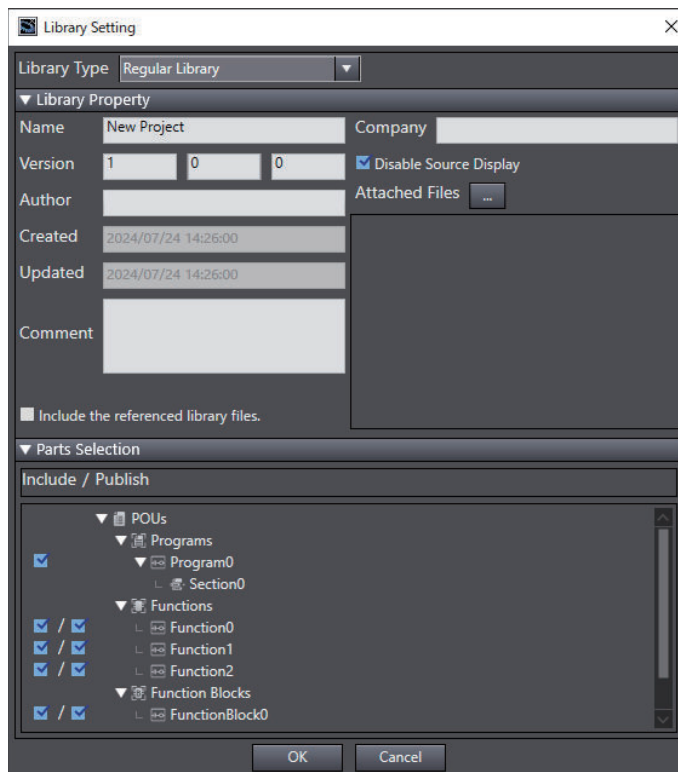

- 2 Set the library properties in the Library Setting Dialog Box, and select the objects.
After you make all of the settings, click the **OK** Button.

- Library Type

Item	Description
Regular Library	Creates a regular library.
Library Without Source Code	Creates a library without source code. This library prevents leakage of source code from the library for enhanced security.

- Library Properties

Item	Description
Name	Enter the name of the library.

Item	Description
Version	Enter the version and revision of the library.
Author	Enter the name of the creator of the library. (This setting is optional.)
Comment	Enter the a comment for the library. (This setting is optional.)
Company	Enter the name of the company that created the library. (This setting is optional.)
Disable source display	Specify whether to show or hide the source when the library objects are reused. The source is not displayed if this check box is selected.
Attached files	Specify the path to a file to attach to the library. The specified file is loaded to the library file. You can attach more than one file.
Include the referenced library files	If the current library project accesses another library, select whether to include the data from the accessed library in the library that you create.

- Parts Selection

Item	Description
Include	Select the objects (programs* ¹ , functions, function block definitions, and data types) to include in the library. Clear the check boxes of any objects not to include in the library. Data types are always included in the library.
Publish* ²	You can allow Controllers that access the library to use the selected functions and function block definitions. If you select check boxes, the selected POUs are displayed in the Toolbox for the Controller and in entry candidates displayed when programming. You can select a Publish Check Box only when the corresponding Include Check Box is selected.

*1. You can select programs as library objects with Sysmac Studio version 1.06 or higher. You cannot reference libraries that include programs with Sysmac Studio version 1.05 or lower. Also, you cannot open or import projects that have libraries that include programs with Sysmac Studio version 1.05 or lower.

*2. Caution is required to use the created library on Sysmac Studio version 1.13 or lower. Refer to *Version Information*, below.



Additional Information

To create a library without source code, the following conditions must be met.

- No programs are selected (included in the library) in the **Parts Selection** category.
- All functions and function blocks are selected (included in the library) in the **Parts Selection** category.
- External variables used in the functions and function blocks are system variables only.
- No AT specifications for internal variables are specified in the function blocks.
- Data protection is not set for the functions and function blocks.
- No other libraries are referred.
- A Controller with unit version that supports libraries without source code is set. Refer to *Version Information* below for unit versions.

3 Version Information

Select the **Publish** Check Boxes for all library objects in the following cases.

- When you will use a library created on Sysmac Studio version 1.14 or higher on Sysmac Studio version 1.13 or lower
 - When you will open a library saved on Sysmac Studio version 1.14 or higher on Sysmac Studio version 1.13 or lower
 - When you will connect Sysmac Studio version 1.13 or lower to a Controller to which a project that accesses a library created on Sysmac Studio version 1.14 or higher was downloaded
- If there is even one library object for which the **Publish** Check Box was not selected, you cannot access the library on Sysmac Studio version 1.13 or lower and you cannot open the library project on Sysmac Studio version 1.13 or lower.

Libraries without source code is supported by the following project unit versions.

Controller	Project unit version
NJ-series	Version 1.64 or later
NX1P2	Version 1.64 or later
NX102	Version 1.64 or later
NX502	Version 1.66 or later
NX701	Version 1.35 or later
NY-series	Version 1.26 or later

3 Select **Library – Create Library** from the **Project** Menu.

A Create Library File Dialog Box is displayed.

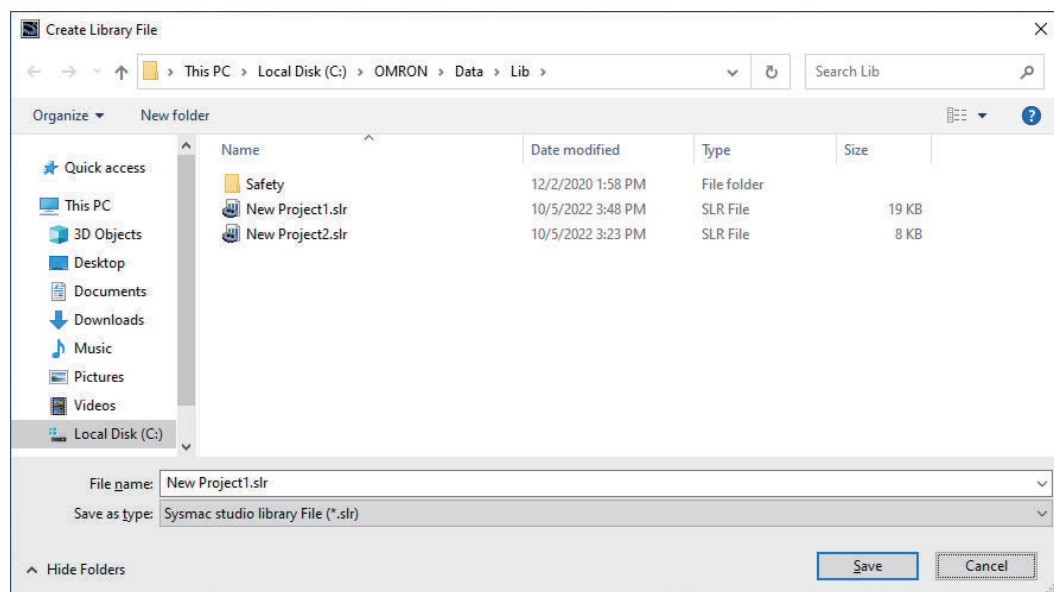

4 Select the folder in which to save the library file, enter the file name, and then click the **Save** Button.

The library file is created.

Information on the created library file*¹ is displayed in the Output Tab Page.

*1. A unique ID for comparing libraries is automatically generated.

9-3-2 Using a Library

You can read a library file that you created into a project and use the objects from it. You can use the library objects that are read in the same way as you can use programs, functions, function block definitions, and data types that you create in the project.

Use the following procedures to use a library.

- 1 Library Reference
- 2 Using Library Objects

Library Reference

● Library Reference

You must register a library to use it in a project. The library file to use is read into the project.

- 1 Select **Library – Show References** from the **Project** Menu.

A Library Reference Dialog Box is displayed.

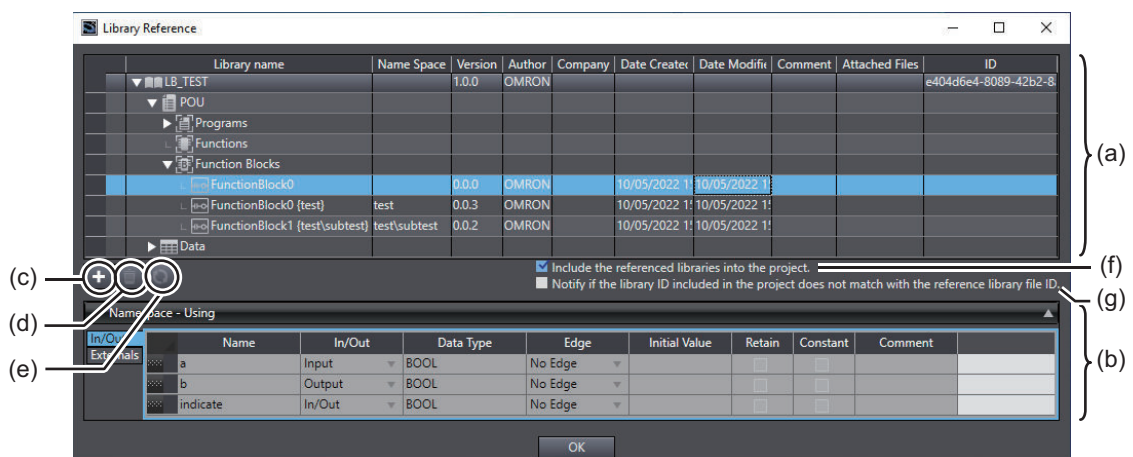

Item	Description
(a) Library View	A list of the libraries that are currently accessed is displayed. Library property information is displayed. Click the (▶) Buttons to expand the tree and display the objects in the libraries. An information icon appears at the left end of the library row if the library ID included in the project does not match the ID of the reference library file.
(b) Interface View	The data that you can access in the library parts is displayed.
(c) Create Reference Button	Click this button to read a library file and add it to the project.
(d) Delete Reference Button	Click this button to remove a library from the list of accessed libraries.
(e) Update the libraries included in the project Button	Click this button when the Include the referenced libraries into the project Button. Check Box is selected to update the libraries in the project with the content of the reference library file.
(f) Include the referenced libraries into the project.	If you select this check box and then save or export the project, the library files that are accessed in the project will be included in the saved or exported data. You can select this setting for each Controller, which will be transferred together with the program to the Controller.

	Item	Description
(g)	Notify if the library ID included in the project does not match with the reference library file ID.	<p>If you select this check box and then save or export the project or transfer the user program to a Controller, the library ID included in the project will be checked against the ID of the reference library file at the following timings and a message will appear if they do not match.</p> <ul style="list-style-type: none"> • When a saved project is opened • When an exported project is imported • When a program that was transferred to a Controller is uploaded • When the backup file of a program that was transferred to a Controller is imported

- 2** Click the *Create Reference* Button in the Library Reference Dialog Box. A Refer to Library File Dialog Box is displayed.

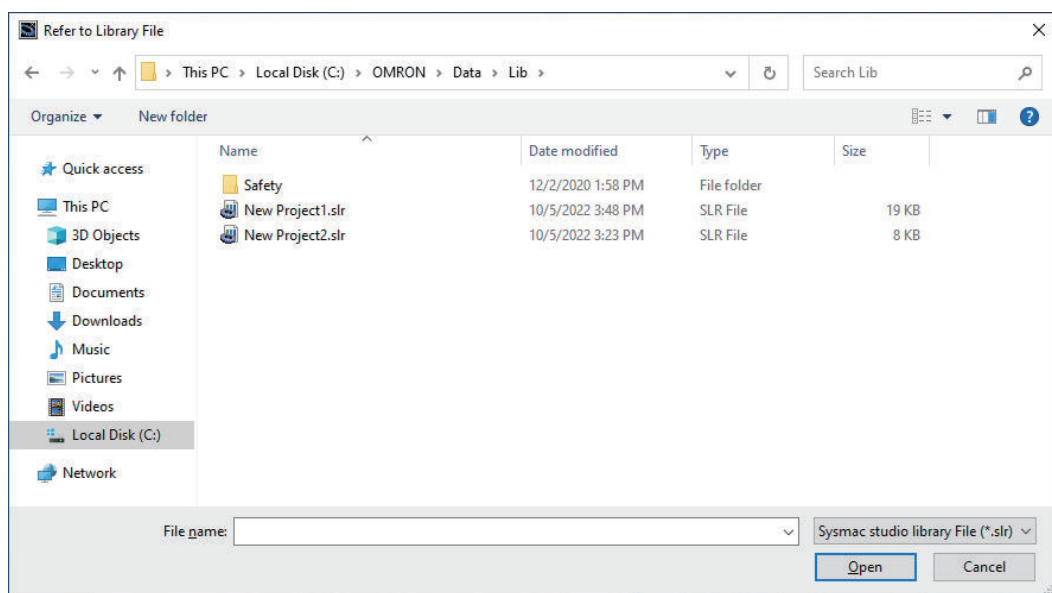

- 3** Select the library file to read into the project and click the **Open** Button. The library file is read so that you can use the library objects in the project.



Precautions for Correct Use

- If the fully qualified name of a library object that you attempt to use already exists in the project or in a library object that was previously read, an error occurs and the library object is not read. Be sure that all names are unique.
- If both the short name of a library object and the company name in the library properties already exist for a library object that was previously read, an error occurs and the library object is not read. Make sure that the names and company names are not duplicated between library objects.
- Note this if you do not select to include the referenced libraries into the project: If the library ID included in a Controller is different from the reference library file ID, it may happen during verification after transfer to the Controller that the POUs, variables, or data types that reference libraries mismatch.



Additional Information

- If the library properties are set to display the source, you can right-click a program, function, or function block definition in the Library View and select **Display Source** to display the source of the program, function, or function block definition.
- If data protection is set for a library object for which you try to display the source code, you must enter the password for data protection.
- When you import library project files with the **Include the referenced libraries into the project. (Include the referenced libraries when saving the project** in Sysmac Studio version 1.17 or lower) Check Box selected, the save location for the reference library file depends on the Sysmac Studio version.

Version	Save location	
Version 1.14 or higher	When the accessed library file was saved under the folder specified in the OS environment variable USERPROFILE when the project was exported:	Under the folder specified in the environment variable USERPROFILE on the computer where the file is imported
	When the library file is saved in any other folder	A folder* ¹ with the same name as the folder in which the library file was saved when the project was exported
Version 1.13 or lower	A folder* ¹ with the same name as the folder in which the library file was saved when the project was exported	

*1. If a folder with the same name does not exist, a new folder is created.

- The application scope of the **Include the referenced libraries into the project.** setting differs between Sysmac Studio version 1.17 or lower and version 1.18 or higher.

	Version 1.17 or lower	Version 1.18 or higher
Application scope of Include the referenced libraries into the project. (Include the referenced libraries when saving the project in Sysmac Studio version 1.17 or lower) setting	The setting applies to all Controllers in the project.	The setting can be enabled or disabled for each Controller in the project.
Operation when a project that was exported in version 1.18 or higher is imported in version 1.17 or lower	If the Include the referenced libraries into the project. setting was enabled for one or more Controllers in the project, the Include the referenced libraries when saving the project setting is enabled for the imported project.	---

- The following conditions must be met for a library to reference libraries without source code.
 - a) The library type is set to *Regular Library*. *¹
 - b) **Include the referenced libraries into the project** is selected.
 - c) The same Controller model is set for the referencing project and the library. *²
 - d) The Controller version set for the referencing project is later than the Controller version set for the library. *²

*1. When the type of the referencing project is library project

*2. If the project references libraries without source code, you cannot change the device in the Change Device Dialog Box. Note also that the Controller version is restricted by the referencing libraries without source code. To change the device without being restricted, delete references to all libraries without source code before you perform Change Device. Then, reference libraries without source code that meet the requirements again.

● Deleting a Library Reference

Use the following procedure to delete a library that you read into the project.

- 1 Select the library, and then click the **Delete Reference** Button. Or, right-click the library and select **Delete Reference** from the menu.

● Updating the Libraries Included in the Project

If the libraries included in the project differ from the reference library file, use this procedure to update the libraries in the project with the content of the reference library file.

- 1 Select the library to update in the Library View and click the **Update the libraries included in the project** Button.

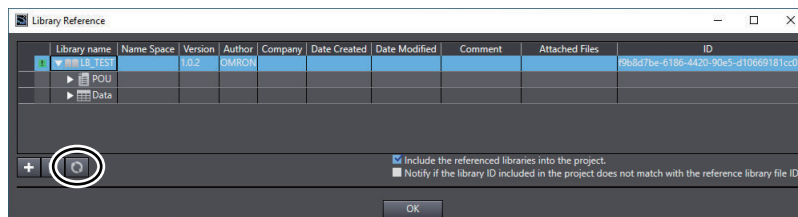

The **Library update confirmation** Dialog Box is displayed.

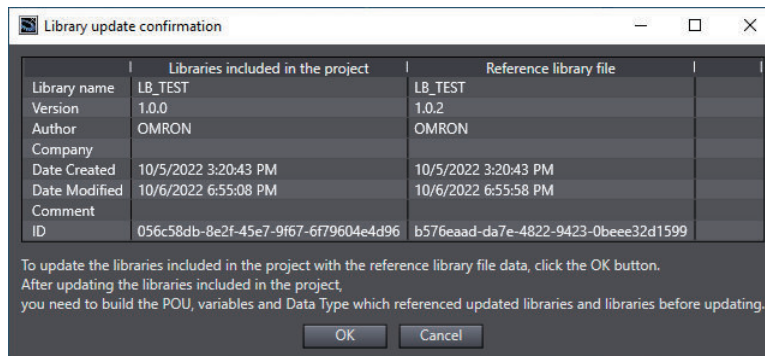

- 2 Check the difference from the reference library file and click the **OK** button to update the libraries included in the project.



Additional Information

After updating the libraries, you may need to build the POUs, variables, or data types that reference libraries.

Using Library Objects

You can use objects in a library that has been read into the project.

You use the objects in the same way as you use any other programs, functions, function block definitions, and data types. Refer to *Section 4 Programming* on page 4-1 for application procedures.

Object	Application method
Programs, functions, and function blocks	You can use these objects to create programs, functions, and function blocks.
Data types	You can use the data types just like any other data types.

To use a library object, enter the name of the library object displayed in the Refer to Library File Dialog Box.

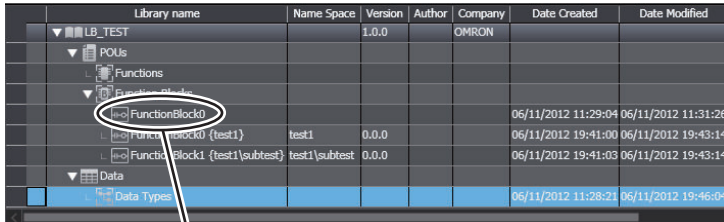

Library object name



Additional Information

If the library object name has a namespace, enter the name of the namespace before the library object name.
Example:

Library object name	Name of namespace	Notation
FunctionBlock1	test1\subtest	\\test1\subtest\FunctionBlock1

● Using Library Objects in the Ladder Editor

In the Ladder Editor, objects that are read by accessing libraries are displayed in the Toolbox. You can drag these objects from the Toolbox in the same way as for other circuit parts to insert them into the program.

- 1 Display the library objects to add in the Toolbox of the Ladder Editor.

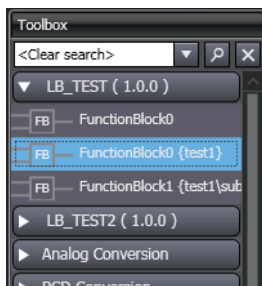

- 2 Drag the library object to the ladder diagram. The function block from the library is inserted.

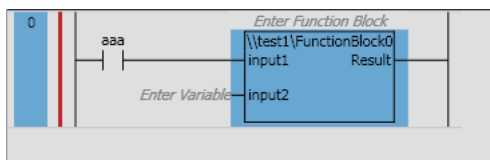

9-4 Program Sharing in Derived Devices

A derived device is a device that is developed based on a certain device by adding and changing some functionality. A common program is used in a derived device and the device from which it is derived.

Use the following procedures to share programs among more than one device.



Version Information

To use this function, Sysmac Studio version 1.20 or higher and a CPU Unit with unit version 1.16 or later are required.

9-4-1 Overview of Sharing Programs in Derived Devices

Use the following information to share the same POU, data types, and global variables among more than one Controller that is registered in a project.

Sharing Target

You can share the following data.

- POU, (Programs, functions, and function blocks)
- Data types
- Global variables



Additional Information

POUs and global variables of the Safety CPU Unit are not shared.

Sharing Methods

Use the following sharing methods.

- Deriving a device from the sharing source Controller
Create a copy of the source Controller to share the target data. You can share either all of the POU, data types, and global variables at a time, or only the data that is already shared.
- Configuring the sharing settings for POU, data types, and global variables individually
Share the POU, data type, and global variable data individually. To share a POU, copy the data from the sharing source Controller to the sharing destination Controller. To share a data type or global variable, overwrite the data in the sharing destination Controller with the data in the sharing source Controller.



Precautions for Correct Use

- You cannot use this function for library projects. In addition, you cannot change projects that include any Controller that uses this function into library projects.
- When a Safety CPU Unit exists in the CPU rack, you cannot derive a device from the Controller.



Additional Information

Registering a large number of derived devices (Controllers) in a project may result in low job performance depending on your computer environment, because the Sysmac Studio consumes a significant amount of computer memory.

If the number of derived devices in a project is likely to increase, use this function with *Sharing a Machine Project with EtherCAT Configuration* on page 9-2.

9-4-2 Procedure to Share a Program

Use the following procedure to share a program.

Creating a Derived Device

Use the following procedure to create a derived device.

- 1 With the deriving source Controller displayed in the Multiview Explorer, right-click the device icon and select **Derive Device - Share All Programming Data** from the pop-up menu. Or, select **Derive Device - Share All Programming Data** from the **Insert** Menu. To share only the data that is already shared, select **Share Shared Programming Data**.

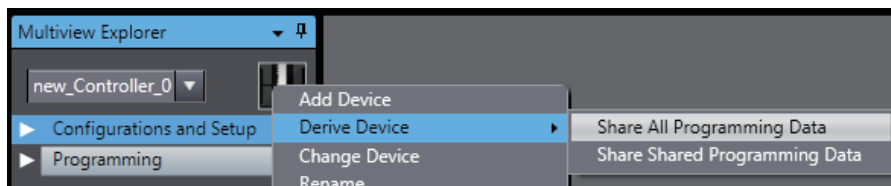

The **Derive Device** Dialog Box is displayed.

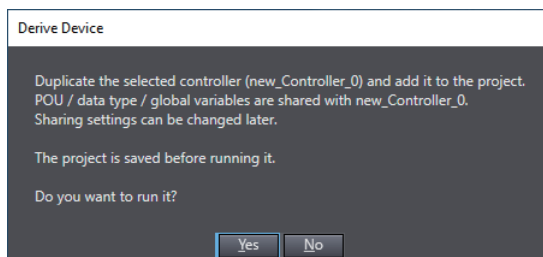

- 2 Click the **OK** Button.
A copy of the Controller is added to the project.
For data that is shared, the icons change to indicate the shared status.

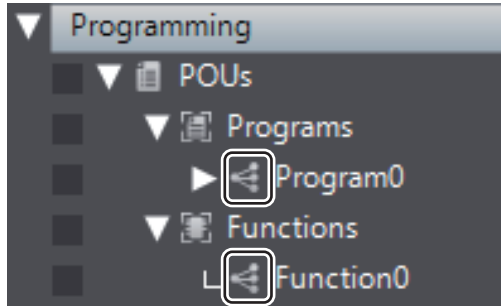

Configuring the Sharing Settings for POUs, Data Types, and Global Variables

Use the following procedure to configure the sharing settings for POUs, data types, and global variables.

● For POUs

The following example is for a program.

- 1 Right-click the target program in the Multiview Explorer and select **Sharing setting between devices** from the pop-up menu.

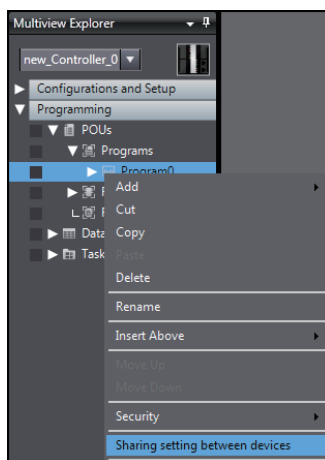

The **Sharing setting between devices** Dialog Box is displayed.

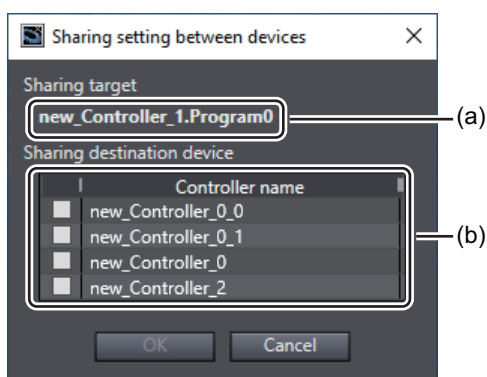

	Item	Description
(a)	Sharing target	The selected data is displayed.
(b)	Sharing destination	All Controllers that are included in the project are displayed.

- 2 Select the check boxes for the Controllers whose data to share, and then click the **OK** Button. You can select more than one Controller. A dialog box is displayed to indicate that the sharing is completed.

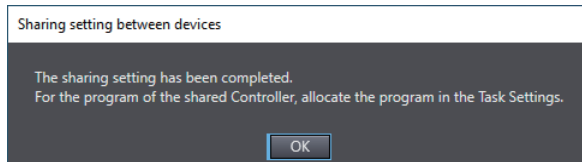

- 3 Click the **OK** Button. For data that is shared, the icons change to indicate the shared status.



Precautions for Correct Use

- You cannot configure the sharing settings if a POU with the same name as that of the target POU exists in Controllers in the sharing destination. If so, rename the POU in the Controllers in the sharing destination, or delete the POU and configure the sharing settings again.
- The sharing target is only the selected data. Note the following when you select a POU for sharing.
 - a) Although the external variables that are used in POUs are shared, global variables are not shared. This means that an error occurs if the corresponding global variables do not exist in Controllers in the sharing destination. In this case, share also the global variables as needed.
 - b) For POUs that reference libraries, the library reference settings are not copied to Controllers in the sharing destination. Copy the library reference settings as needed.

● For Data Types and Global Variables

- 1 Right-click **Data Types** or **Global Variables** in the Multiview Explorer, and select **Sharing setting between devices** from the pop-up menu. The **Sharing setting between devices** Dialog Box is displayed.
- 2 Select the check boxes for the Controllers whose data to share, and then click the **OK** Button. You can select more than one Controller. A confirmation dialog box is displayed, which asks whether to overwrite data.

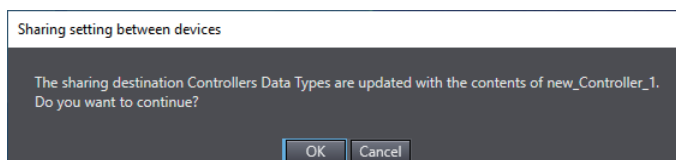

- 3 Click the **OK** Button. For data types, data including the namespace name is shared. For data that is shared, the icons change to indicate the shared status.



Precautions for Correct Use

- You cannot select Controllers that are already shared with another Controller in the **Sharing setting between devices** Dialog Box. Their check boxes are disabled.
- To add a new Controller to the sharing destination of data, display the **Sharing setting between devices** Dialog Box for the target data in the sharing source Controller and add it there. Refer to *Adding a Sharing Target Controller* on page 9-23 for details.
- Among global variables, the following data is not the sharing target. This means that the data in the sharing source is not copied.
 - a) Axis variables, axes group variables, cam data variables, and cam definition variables
 - b) **AT** values of variable attributes
- You cannot configure the sharing settings if a variable with the same name exists in the global variable table in the sharing target. Rename it to a unique name, and then try again.
- If a variable with the same name exists in the global variable table in the sharing destination, all attributes except for the **AT** attribute will be overwritten.
- If an axis variable, axes group variable, cam data variable, or cam definition variable with the same name as that of a user-defined variable in the sharing source exists in the sharing destination, it will be registered with the same name as a different variable from the axis variable, axes group variable, cam data variable, or cam definition variable. In this case, a duplicate name error will occur. Rename the user-defined variable to a unique name.
- Variables that exist only in Controllers in the sharing destination will be deleted.
- The order of variables will not be shared.

9-4-3 Editing Shared Data

The following describes the operations and operational precautions that apply when you edit shared data.

Operations and Results for POU's, Data Types, and Global Variables

You can edit shared data from any Controller that shares it. Regardless of from which Controller you edit shared data, the edited data is shared among the Controllers.

The table below describes the operations that you can perform on shared data and the results of the operations.

Shared data	Item	Operation	Result
POUs	---	Renaming	After operation, the data is shared. However, you cannot rename data if a POU with the same name exists in Controllers in the sharing destination. Rename the applicable POU in the Controller in the sharing destination or delete the POU, and then try again.
	Sections (Programs)	Edition, addition, deletion, order change, renaming	After operation, the data is shared.
	Properties of POUs	Edition	
	Data protection settings	Setting, release, temporary release of change prohibition, finishing temporary release of change prohibition	
	Local variables	Edition, addition, deletion	After operation, the data is shared. However, the AT values are not shared and retained by each Controller.
	Breakpoints	All operations	After operation, the data is not shared. The data is retained by each Controller.
	Bookmarks		
Settings for debugging			
Data types	---	Edition, addition, deletion, order change	After operation, the data is shared.
Global variables	---	Edition, addition, deletion	After operation, the data is shared. However, the AT values are not shared and retained by each Controller.

Change Device

You cannot change Controllers in a sharing relationship to other Controllers with unit version 1.15 or earlier. Cancel the sharing relationship before you change to other devices. Refer to *Canceling a Sharing Relationship* on page 9-24 for the procedure to cancel a sharing relationship.

Build

Build the project for each Controller. The building results are not shared and retained by each Controller.

If shared data is changed by another Controller after building, you must rebuild the project.

Search and Replace

If you replace strings in shared data, the changes made to the data will be shared with other Controllers.

Online

If you edit shared data, the changes made to the data will be shared with online Controllers that share the data.

The table below describes the operations that you can perform online on shared data and the results of the operations.

Online function	Operation	Result
Transfer from Controller	Transferring only part of shared data	The data is updated and the changes made to the Controller are shared among Controllers.
	Transferring all data from a physical Controller, transferring data from a physical Controller for which Do not transfer the program source setting is enabled	All the shared data is overwritten with the data of the physical Controller, with the sharing of the data with all other Controllers canceled. At this time, the sharing relationship among other Controllers remains unchanged.
	From a physical Controller, transferring the data that has been transferred with the Do not transfer the comments and the programming group information to the controller setting	
Monitoring	Changing the present value display setting	The changes are not shared. The data is displayed in the display format that is set for each Controller.
Online editing	Changing the data	The changes are shared.



Precautions for Correct Use

If you make changes to shared data from another Controller after matching it with the data of a physical Controller, the data will not match with the data of the physical Controller. Be careful that, if you make changes to shared data without being aware of the sharing relationship among other Controllers, you will end up in having data in the Sysmac Studio that does not match the data of Controllers connected online.

9-4-4 Changing a Sharing Relationship

Use the following procedures to change a sharing relationship among Controllers.

You can perform the following operations to change a sharing relationship.

- Adding a sharing target Controller
- Canceling a sharing relationship
- Deleting a POU
- Deleting a Controller

Adding a sharing target Controller and canceling a sharing relationship are performed in units of shared data (POUs, data types, or global variables).

Adding a Sharing Target Controller

Use the following procedure to add a sharing target Controller to a group of Controllers in a sharing relationship.

- 1 Right-click **Data Types** or **Global Variables** in the Multiview Explorer, and select **Sharing setting between devices** from the pop-up menu.
The **Sharing setting between devices** Dialog Box is displayed.
- 2 Select the check boxes for the Controllers to add as a sharing target, and then click the **OK** Button.
A confirmation dialog box is displayed and the selected Controller is added as a sharing target.



Precautions for Correct Use

- You cannot configure the sharing settings if a POU with the same name as that of the target POU for the Controller to add exists. If so, rename the POU in the Controllers in the sharing destination, or delete the POU and configure the sharing settings again.

Canceling a Sharing Relationship

Use the following procedure to remove a Controller in a sharing relationship from the sharing target Controllers.

- 1 Right-click POUs, **Data Types**, or **Global Variables** in the Multiview Explorer, and select **Sharing setting between devices** from the pop-up menu.
The **Sharing setting between devices** Dialog Box is displayed.
- 2 Clear the check boxes for the Controllers to cancel the sharing relationship, and then click the **OK** Button.
If the target is a data type or global variable, the sharing relationship is canceled.

If the target is a POU, a confirmation dialog box is displayed, which asks whether to delete the target POU from the Controller simultaneously when canceling the sharing relationship.

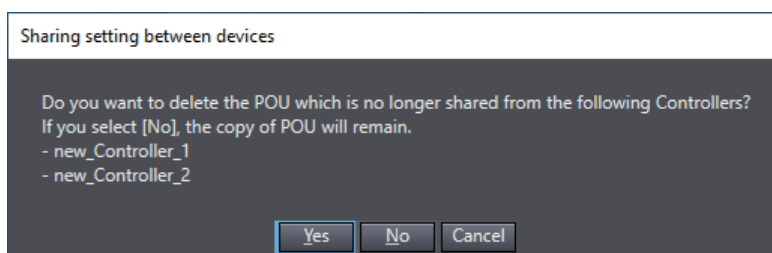

- 3 Click the **Yes** Button to delete the target POU. Click the **No** Button to leave the target POU.
The sharing of the target is canceled. If you click the **Yes** Button, the target POU is deleted.

Deleting a POU

You can delete a POU from the pop-up menu that appears when you right-click the target POU. The table below describes the results when you delete a Controller in a sharing relationship.

Pop-up menu command	Result
Delete	Use this command to delete only the target POU for the selected Controller.
Delete with sharing target	Use this command to delete the target POUs for all the Controllers in a sharing relationship.

Deleting a Controller

Deleting a Controller in a sharing relationship neither cancels the sharing relationship with other Controllers in the sharing destination nor deletes the share data.

However, if there is only one Controller that has a sharing relationship with the deleted Controller, the sharing relationship with the Controller is canceled.

Support Software Provided with the Sysmac Studio

This section describes the Support Software that is provided with the Sysmac Studio.

10-1	Support Software Provided with the Sysmac Studio.....	10-2
10-2	Starting and Exiting the Support Software	10-4
10-2-1	Starting the Support Software Provided with Sysmac Studio.....	10-4
10-2-2	Exiting the Support Software Provided with Sysmac Studio	10-4

10-1 Support Software Provided with the Sysmac Studio

● Overview of Support Software

The following table shows the overview of Support Software for the Sysmac Studio. For the operating procedures on Support Software, refer to the reference manual or Help of each software.

Support Software	Description	Reference manual/Help
CX-Integrator	Configures networks (data links, routing tables, Communications Unit settings, etc.).	CX-Integrator Operation Manual (Cat. No. W464)
CX-Designer	Creates screen data for NS-series Programmable Terminals.	CX-Designer User's Manual (Cat. No. V099)
CX-Protocol	Creates data transfer protocols for general-purpose devices connected to CJ-series Serial Communications Units.	CX-Protocol Operation Manual (Cat. No. W344)
Network Configurator	Configures tag data links for the built-in EtherNet/IP ports on NJ/NX-series CPU Units or NY-series Industrial PCs.	NJ/NX-series CPU Unit Built-in EtherNet/IP Port User's Manual (Cat. No. W506) or NY-series Industrial Panel PC / Industrial Box PC Built-in EtherNet/IP Port User's Manual (Cat. No. W563)
CX-ConfiguratorFDT	Performs setup for communications between IO-Link master and slave units.	CX-ConfiguratorFDT Help
Adept Robot IP Address Setting Tool	Changes IP addresses and subnet masks for Adept Robot and SmartController EX.	Adept Robot IP Address Setting Tool Help

● Units Supported by the Sysmac Studio and Applicable Support Software

NX Units and EtherCAT Slaves

Model	Unit name	Applicable Support Software	Relevant Manuals	Cat. No.
NX-ILM400	IO-Link Master Unit	CX-ConfiguratorFDT	IO-Link System User's Manual	W570
GX-ILM08C				
NXR-ILM08C-ECT			NXR-series IO-Link Master Unit for EtherCAT User's Manual	W640

CPU Bus Units and Special I/O Units

Model	Unit name	Applicable Support Software	Relevant Manuals	Cat. No.
CJ1W-DRM21	DeviceNet Unit	CX-Integrator	CX-Integrator Operation Manual	W464
CJ1W-CRM21	CompoNet Master Unit (unit version 1.3 or later)			
CJ1W-EIP21	EtherNet/IP Unit with unit version 2.1 or later	Network Configurator	CJ-series EtherNet/IP Units Operation Manual for NJ-series CPU Unit	W495
CJ1W-EIP21S	EtherNet/IP Unit			

Model	Unit name	Applicable Support Software	Relevant Manuals	Cat. No.
CJ1W-SCU22	Serial Communications Units	CX-Protocol	CX-Protocol Operation Manual	W344
CJ1W-SCU32				
CJ1W-SCU42				

Programmable Terminals (HMIs)

Model	Unit name	Applicable Support Software	Relevant Manuals	Cat. No.
NS Series	Programmable Terminals	CX-Designer	CX-Designer User's Manual	V099

10-2 Starting and Exiting the Support Software

This section describes how to start and exit the Support Software that is provided with the Sysmac Studio.



Precautions for Correct Use

Observe the following precautions when you start the Sysmac Studio or any of the Support Software that is provided with it.

- Exit all applications that are not necessary to use the Sysmac Studio. For virus checker or other software that could affect the startup and operations of the Sysmac Studio, take measures such as to remove the Sysmac Studio from the scope of virus checking.
- If any hard disks or printers that are connected to the computer are shared with other computers on a network, isolate them so that they are no longer shared.
- With some notebook computers, the default settings assign the USB port to a modem or infrared communications. Refer to the user documentation for your computer and set the USB port as a normal serial port.
- With some notebook computers, the default settings do not supply power to the USB port or Ethernet port to save energy. There are energy-saving settings in Windows, and also sometimes in utilities or the BIOS of the computer. Refer to the user documentation for your computer and disable all energy-saving features.

10-2-1 Starting the Support Software Provided with Sysmac Studio

Use the following procedure to start the Support Software that is provided with the Sysmac Studio.

- 1** Select **All Programs - OMRON - Sysmac Studio** from the Windows **Start Menu**.
A list of the Support Software is displayed.
- 2** Select the Support Software to start. (Example: CX-Integrator)

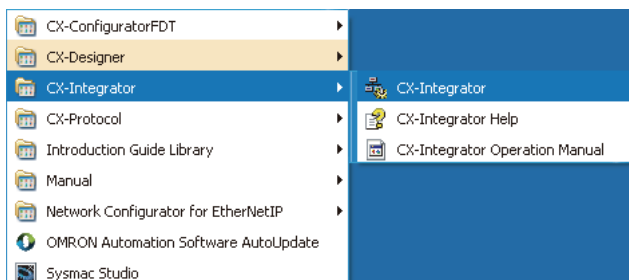

The main window for the Support Software is displayed.

10-2-2 Exiting the Support Software Provided with Sysmac Studio

Use the following procedure to exit the Support Software that is provided with the Sysmac Studio.

- 1** Select **Exit** from the **File Menu**.

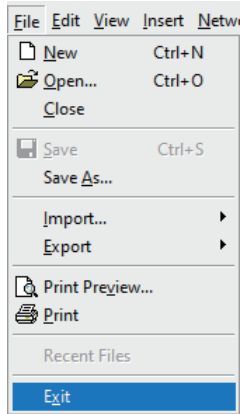

The Support Software provided with Sysmac Studio is exited.



Additional Information

If there is unsaved data when you select **Exit** from the menu, a dialog box will prompt saving the data before the Sysmac Studio Support Software is exited. Save the data if it is required. Refer to the relevant manual for details.



Troubleshooting

This section describes the error messages that are displayed when you check a program on the Sysmac Studio and how to correct those errors.

11-1	Error Messages for Ladder Program Checks	11-2
11-2	Error Messages for Structured Text Checks	11-7
11-3	Error Messages for Variable Check.....	11-10
11-4	Error Messages for Sysmac Studio Operation.....	11-11

11-1 Error Messages for Ladder Program Checks

The following table lists the ladder program error messages that are displayed in the Output Tab Page when detected during a program check on the Sysmac Studio.

Error message	Error level	Cause	Correction
A parameter is not entered for the input.	Error	Refer to the error message.	Enter a parameter for the input.
A parameter is not entered for the output.	Error	Refer to the error message.	Enter a parameter for the output.
A parameter of the MC instruction is invalid. Execute the program check to correct the parameter.	Error	The MC or MCR number argument does not match the MC or MCR level number.	Correct the MC or MCR instruction parameter.
A variable not registered in the local variable table exists. To use a global variable, a corresponding external variable must be registered. Register it by right-clicking the variable and selecting Register in variable table from the context menu.	Error	A global variable is defined, but the corresponding external variable is not defined.	If you want to use the global variable, register an external variable that corresponds to the global variable. If you want to use a variable other than the global variable, correct the variable name.
A variable not registered in the variable table exists. Register it by right-clicking the variable and selecting Register in variable table from the context menu.	Error	Refer to the error message.	Register the variable in the variable table or enter the correct variable name.
A variable whose data type is not defined is used.	Error	Refer to the error message.	Define the data type or enter the correct variable name.
Any item other than output cannot be connected after an output.	Error	Refer to the error message.	Remove any connections other than outputs after the output.
An element comment can contain up to 250 characters.	Error	Refer to the error message.	Reduce the number of characters in the element comment.
An exception such as memory shortage has occurred.	Error	An object file could not be created due to insufficient memory.	Reduce the sizes of the individual POUs as given below, e.g., by separating individual POUs into two or more POUs. POUs that are ladder programs: Separate the programs into two or more sections. Global variables: Use structures or arrays to combine variables or use local variables instead of global variables whenever possible.
Any parameters other than WORD data may result in an unexpected operation.	Warning	Unintended operation may occur if you use a parameter that is not WORD data.	Correct the usage of parameter data types.

Error message	Error level	Cause	Correction
At least one BOOL input variable and at least one BOOL output variable or return variable must be defined.	Error	Refer to the error message.	Correct the input variable, output variable, or return value variable of the function or function block.
Be careful not to make the scan time too long when moving upward on the program.	Warning	A jump was made to an earlier part of the program.	Correct the jump so that it does not go to an earlier part of the program.
Cannot jump into inside the FOR-NEXT loop.	Error	You attempted to jump to a location inside a FOR ... NEXT construct from outside the FOR ... NEXT construct.	Correct the usage of the FOR and NEXT instructions.
Contacts must not be connected to the right bus bar.	Error	The input is connected to the right bus bar.	Correct the rung.
Data may be lost during conversion.	Warning	Some data may be lost in the conversion.	Correct how the data is converted.
data_type_name cannot be converted to data_type_name .	Error	You cannot convert the data to the specified data type.	Correct how the data is converted.
Inline ST can contain up to 1,000 rows.	Error	The Inline ST box contains more than 1,000 lines.	Reduce the number of lines in the Inline ST box.
Invalid pair of data types. Execution result may be lost.	Error	You cannot specify a combination of data types that may result in the loss of execution results.	Correct the usage of the data types.
Invalid pair of input parameters.	Error	The specified combination of input parameter data types is incorrect.	Correct the usage of input parameter data types.
It is not recommended to use global variables in a function.	Warning	You used a global variable in a function.	Correct the usage of global variables in functions.
instruction_name requires a variable with the range specified.	Error	You specified a variable that does not have a range specification.	Correct the usage of the instruction, or specify the variable with a range specification.
Literal cannot be used in an input parameter of a in-out variable.	Error	A literal was specified for the parameter on the input side for an in-out variable.	Correct the parameter on the input side for the in-out variable.
Literal format is wrong or the data type is not available.	Error	The format of the literal is incorrect, or you attempted to use a text string literal as a different data type.	Correct the usage of literals, including the format.
member_name is not a member of the data_type_name data type.	Error	You specified an undefined member name after the period.	Define the member or correct the member specification.
No JUMP instruction specifies the label in the same section.	Warning	This warning is displayed when only a label is defined in a section.	Correct the usage of jumps and labels.
No need to round integer type variables.	Warning	Execution is not required for integer variables.	Correct the usage of the integer variables.
No value can be written to a literal.	Error	You attempted to output to a literal.	Correct the output.
No value can be written to a variable with Read Only attribute set in the task setting.	Error	You specified a variable that can be accessed in the task as an output parameter.	Correct the usage of the accessing tasks.
No value can be written to a variable with the Constant attribute.	Error	You specified a variable with the Constant attribute as an output parameter.	Correct the usage of the Constant attribute for the variable.

Error message	Error level	Cause	Correction
No value can be written to an input variable.	Error	You attempted to write a value to an input variable inside a function or function block.	Correct the usage of input variables in functions and function blocks.
No value can be written to input, output, or in-out variables of a function block instance.	Error	You attempted to write a value to the output variable, input variable, or in-out variable of an instance variable.	Correct the usage of variables of function block instances.
No value can be written to the enumerated type of variables.	Error	You attempted to output a value to an enumeration.	Correct the enumeration.
One rung can contain only one inline ST.	Error	There is more than one Inline ST box on the rung.	Correct the usage of inline ST.
One rung can contain up to 1,000 instructions.	Error	Refer to the error message.	Reduce the number of instructions on the rung.
One section can contain up to 1,000 rungs.	Error	You attempted to use more than 1,000 rungs in one section.	Reduce the number of rungs in the section.
Output parameter type does not match output variable type.	Error	The data type of the output parameter does not match the data type of the output variable.	Correct the output parameter or output variable.
Same name is already used for a variable.	Error	Refer to the error message.	Rename the variable or the label.
The actual argument is not a variable.	Error	A constant is specified for a parameter.	Specify a variable for the parameter.
The BREAK instruction is used outside the FOR-NEXT loop.	Error	Refer to the error message.	Correct the usage of the BREAK instruction.
The BREAK instruction must be connected to the right bus bar.	Error	Refer to the error message.	Correct the usage of the BREAK instruction.
The END instruction cannot be used in a function or function block.	Error	Refer to the error message.	Remove the END instruction from the function or function block.
The END instruction must be used alone on a rung. The rung cannot contain any other elements.	Error	Refer to the error message.	Correct the usage of the END instruction.
The FOR instruction must be used alone on a rung. The rung cannot contain any other elements.	Error	Refer to the error message.	Correct the usage of the FOR instruction.
The MC instruction must be connected to the right bus bar.	Error	Refer to the error message.	Correct the output of the MC instruction.
The MCR instruction must be used alone on a rung. The rung cannot contain any other elements.	Error	Refer to the error message.	Correct the usage of the MCR instruction.
The NEXT instruction must be used alone on a rung. The rung cannot contain any other elements.	Error	Refer to the error message.	Correct the usage of the NEXT instruction.
The program is not assigned to Task Settings.	Warning	Refer to the error message.	Review the Task Settings and correct an unassigned setting item of the program to execute, if any.
The RETURN instruction cannot be used in a program POU.	Error	The RETURN instruction was used in a program.	Remove the RETURN instruction from the program.

Error message	Error level	Cause	Correction
The RETURN instruction must be used alone on a rung. The rung cannot contain any other elements.	Error	Refer to the error message.	Correct the usage of the RETURN instruction.
The array dimension is not correctly specified.	Error	The array dimensions used do not match the array definition.	Correct the array definition or correct the array dimensions.
The array expression is invalid.	Error	The array expression is incorrect, there is no right bracket, or there is a character after the right bracket.	Correct the array expression.
The array index is out of range.	Error	The literal used for the array subscript is outside of the range of the array.	Correct the array definition or correct the array subscript.
The data type range is decreased in the conversion from data_type_name to data_type_name .	Error	You cannot convert the variable to the specified data type.	Correct how the data is converted.
The data_type_name data type is not defined.	Error	You attempted to use a variable with an undefined data type.	Define the data type or enter the correct variable name.
The downward differentiation condition cannot be specified for the instruction_name instruction.	Error	The instruction does not support the ~ condition.	Correct the usage of the instruction_name instruction.
The function block definition name is empty.	Error	Refer to the error message.	Enter a function block definition name.
The function block name is not defined.	Error	Refer to the error message.	Define the function block or enter the correct function name.
The function name is empty.	Error	Refer to the error message.	Enter a function definition name.
The function name is not defined.	Error	Refer to the error message.	Define the function or enter the correct function name.
The inline ST box must be connected to the right bus bar.	Error	Refer to the error message.	Correct the usage of inline ST.
The input parameter cannot be omitted for an in-out variable.	Error	The in-out variable does not have a parameter on the input side.	Enter a parameter on the input side for the in-out variable.
The input parameter types cannot be converted to the output parameter types.	Error	Refer to the error message.	Correct how the data is converted.
The input used as an internal bit is not written from others.	Warning	Refer to the error message.	Check the access relationships of the work bit input.
The instance is doubly used, which may cause an unintentional operation.	Warning	Refer to the error message.	Correct the usage of the instance.
The instance variable is empty.	Error	Refer to the error message.	Enter an instance variable.
The label is empty.	Error	No label was entered for a Jump instruction (->>) or Label instruction.	Enter a label.
The label specified for the jump destination does not exist in the same section.	Error	A label for the jump target does not exist in the same section.	Correct the usage of jumps and labels.
The label specified for the jump destination is used more than once.	Error	Refer to the error message.	Correct the usage of jumps and labels.

Error message	Error level	Cause	Correction
The member expression is invalid.	Error	The member expression is incorrect (e.g., "(a..b)").	Correct the member expression.
The output is doubly used, which may cause unintentional operation.	Warning	Refer to the error message.	Correct the usage of outputs.
The output used as an internal bit is not referenced from others.	Warning	Refer to the error message.	Check the access relationships of the work bit output.
The rung cannot be branched before the MC instruction.	Error	Refer to the error message.	Correct the rung before the MC instruction.
The rung cannot be branched or converged after an output.	Error	Refer to the error message.	Remove any branches or joins after outputs.
The rung is disjunct.	Error	There is a disconnection within a rung.	Correct the rung.
The upper limit of nesting levels (15) was exceeded.	Error	Refer to the error message.	Correct the usage of nesting.
The upward differentiation condition cannot be specified for the instruction_name instruction.	Error	The instruction does not support the @ condition.	Correct the usage of the instruction_name instruction.
There is no corresponding FOR instruction in the same section.	Error	A FOR instruction was not found in the same section as a NEXT instruction.	Correct the usage of the FOR and NEXT instructions.
There is no corresponding MC instruction.	Error	You did not include the MC instruction that corresponds to the MCR instruction.	Correct the usage of the MC and MCR instructions.
There is no corresponding MCR instruction inside the FOR-NEXT loop.	Error	There is an MC instruction without an MCR instruction between the FOR and NEXT instructions.	Correct the MC structure between the FOR and NEXT instructions.
There is no corresponding MCR instruction.	Error	You did not include the MCR instruction that corresponds to the MC instruction.	Correct the usage of the MC and MCR instructions.
There is no corresponding NEXT instruction in the same section.	Error	A NEXT instruction was not found in the same section as a FOR instruction.	Correct the usage of the FOR and NEXT instructions.
There is no corresponding NEXT instruction inside the MC-MCR region.	Error	There is a FOR instruction without a NEXT instruction between the MC and MCR instructions.	Correct the FOR structure between the MC and MCR instructions.
Unsigned integers cannot be used together with signed integers.	Error	You cannot use an unsigned integer with a signed integer or a real number.	Correct the usage of unsigned integers, signed integers, and real numbers.
When specifying an output parameter of an in-out variable, it must be same as input parameter.	Error	The parameter on the output side for the in-out variable is not the same as the parameter on the input side.	Use the same parameter on both the input and output sides for an in-out variable.
When using the union data type, specify a member.	Error	You attempted to use a union variable without a period.	Correct the usage of unions.
You can only use the following types for the input parameter.	Error	You specified a data type that cannot be used for an input.	Correct the usage of inputs.

11-2 Error Messages for Structured Text Checks

The following table lists the ST program error messages that are displayed in the Output Tab Page when detected during a program check on the Sysmac Studio.

Error message	Error level	Cause	Correction
"(" is missing.	Error	Refer to the error message.	Insert a left parenthesis.
")" is missing.	Error	Refer to the error message.	Insert a right parenthesis.
"." is missing.	Error	Refer to the error message.	Insert a period.
":" is missing.	Error	Refer to the error message.	Insert a colon.
":=" is missing.	Error	Refer to the error message.	Insert a colon and equals sign (:=).
";" is missing.	Error	Refer to the error message.	Insert a semicolon.
"[" is missing.	Error	Refer to the error message.	Insert a left bracket.
"]" is missing.	Error	Refer to the error message.	Insert a right bracket.
A constant cannot be written.	Error	Refer to the error message.	Correct the usage of constants.
A variable with Constant attribute cannot be written.	Error	Refer to the error message.	Correct the usage of variables with a Constant attribute.
A value is out of range.	Error	Refer to the error message.	Correct the value.
Address cannot be allocated for the variable variable_name . Check the auto allocation option.	Error	Refer to the error message.	Refer to the error message.
An I/O parameter is missing. All I/O parameters must be set.	Error	Refer to the error message.	Set the I/O parameter.
Array dimension or size does not match.	Error	Refer to the error message.	Correct the usage of arrays.
Array index is out of range.	Error	Refer to the error message.	Correct the array index.
Bad Parameter - Variable is not found.	Error	Refer to the error message.	Correct the parameter.
Constant is missing.	Error	Refer to the error message.	Insert a constant.
Conversion from source_data to destination_data may cause data loss.	Error	Refer to the error message.	Correct how the data is converted.
Conversion from source_data to destination_data is impossible.	Error	Refer to the error message.	Correct how the data is converted.
"DO" is missing.	Error	Refer to the error message.	Insert DO.
Definition of the function block definition_name is missing.	Error	Refer to the error message.	Correct the function block definitions.
Definition of the function function_definition_name is missing.	Error	Refer to the error message.	Use the function function_definition_name .
Division by zero	Error	Refer to the error message.	Correct the division operation.
Duplicate variable is specified for the function.	Error	Refer to the error message.	Correct the usage of the variables.
Duplicate variable is specified.	Error	Refer to the error message.	Correct the variable.
'EN' or 'ENO' cannot be used as an input/output variable.	Error	Refer to the error message.	Correct the usage of the 'EN' and 'ENO' variables.
"END_CASE" is missing.	Error	Refer to the error message.	Insert END CASE.

Error message	Error level	Cause	Correction
"END_FOR" is missing.	Error	Refer to the error message.	Insert END FOR.
"END_IF" is missing.	Error	Refer to the error message.	Insert END IF.
"END_REPEAT" is missing.	Error	Refer to the error message.	Insert END REPEAT.
"END_WHILE" is missing.	Error	Refer to the error message.	Insert END WHILE.
End of the comment is not found.	Error	Refer to the error message.	Define the end of the comment.
End of the string is not found.	Error	Refer to the error message.	Define the end of the text string.
Enumerated type identifiers are read only.	Error	Refer to the error message.	Correct the usage of ENUM enumerators.
Failed to retrieve the information of variable variable_name from function block variable table.	Error	Refer to the error message.	Correct the variable name.
Field specifier is missing.	Error	Refer to the error message.	Correct the field specifier.
Function block I/O variable is read only.	Error	Refer to the error message.	Correct the function block I/O variable.
Global variable variable_name is used.	Warning	Refer to the error message.	Correct the usage of the variables.
Identifier is missing.	Error	Refer to the error message.	Insert an identifier.
Invalid format.	Error	Refer to the error message.	Correct the format.
Invalid value	Error	Refer to the error message.	Correct the value.
Missing parameter.	Error	Refer to the error message.	Correct the number of parameter specifications.
member_name is not a member of data_type_variable_name .	Error	Refer to the error message.	Correct the member_name member of data_type_variable .
Negation is not supported by data_type_variable_name data type.	Error	Refer to the error message.	Correct the value or the data type.
Numbers cannot be specified for the NOT operation.	Error	Refer to the error message.	Correct the usage of the NOT expression.
"OF" is missing.	Error	Refer to the error message.	Insert OF.
Output variable of the function is invalid.	Error	Refer to the error message.	Correct the output variable.
Read-only memory is specified as the AT address of the variable variable_name No value can be assigned to the variable.	Error	Refer to the error message.	Correct the AT specification.
String literal is too long.	Error	Refer to the error message.	Correct the text string.
Strings are not currently supported.	Error	Refer to the error message.	Correct the text string.
Structure variables are not supported.	Error	Refer to the error message.	Correct the usage method.
"THEN" is missing.	Error	Refer to the error message.	Insert THEN.
"TO" is missing.	Error	Refer to the error message.	Insert TO.
The AT address specified for the variable variable_name is invalid.	Error	Refer to the error message.	Correct the AT specification.
The FOR loop declaration contains an invalid parameter.	Error	Refer to the error message.	Correct the parameter in the FOR loop declaration.
The array index is invalid.	Error	Refer to the error message.	Correct the array index.
The array is short of dimensions.	Error	Refer to the error message.	Correct the array variable.
The constant is invalid.	Error	Refer to the error message.	Correct the constant.

Error message	Error level	Cause	Correction
The expression is invalid.	Error	Refer to the error message.	Correct the expression.
The function block parameter is mixed data types.	Error	Refer to the error message.	Correct the function block parameter.
The in-out variable is invalid.	Error	Refer to the error message.	Correct the in-out variable.
The input variable variable_name cannot be assigned a value.	Error	Refer to the error message.	Correct the usage of the input variables.
The operation is invalid.	Error	Refer to the error message.	Correct the operation.
The operator_name operator is not supported by data_type_name data type.	Error	Refer to the error message.	Correct the usage of the operator.
The output variable is invalid.	Error	Refer to the error message.	Correct the output variable.
The output variable variable_name cannot be assigned a value.	Error	Refer to the error message.	Correct the usage of the output variables.
The statement is invalid.	Error	Refer to the error message.	Correct the instruction.
The variable does not have enough size.	Error	Refer to the error message.	Correct the variable size.
The variable variable_name is not a parameter of the function.	Error	Refer to the error message.	Correct the variable_name variable.
The variable variable_name is not an in-out variable.	Error	Refer to the error message.	Correct the usage of the variable attributes.
There are too many keywords.	Error	Refer to the error message.	Reduce the number of keywords.
There must be at least one line of valid code (excluding comments).	Error	Refer to the error message.	Insert at least one line of valid code.
Too many dimensions for an array.	Error	Refer to the error message.	Correct the array variable.
Too many parameters are specified.	Error	Refer to the error message.	Correct the variable.
Too many variables are specified for the function.	Error	Refer to the error message.	Correct the variable specifications.
Two variable formats are mixed.	Error	Refer to the error message.	Correct the variable notation.
"UNTIL" is missing.	Error	Refer to the error message.	Insert UNTIL.
Usage mismatch in a variable of the function	Error	Refer to the error message.	Correct the usage of the variables.
Usage mismatch in function block variable	Error	Refer to the error message.	Correct usage of the function block variables.
Usage mismatch. ':= ' cannot be used for an output parameter.	Error	Refer to the error message.	Correct the usage.
Usage mismatch. '=>' cannot be used for an I/O parameter.	Error	Refer to the error message.	Correct the usage.
Usage mismatch. '=>' cannot be used for an input parameter.	Error	Refer to the error message.	Correct the usage.
When using the union data type, specify a member.	Error	You attempted to use a union variable without a period.	Correct the usage of unions.

11-3 Error Messages for Variable Check

The following table shows the variable check error message that is displayed in the Output Tab Page when detected during a program check on the Sysmac Studio.

Error message	Error level	Cause	Correction
Variable concurrency may not be ensured between tasks which reference the network-published variable. Register the network-published variable to the Settings for Exclusive Control of Variables in Tasks to ensure concurrency of the variable value.	Error	Refer to the error message.	Change the Sysmac Studio option settings. Refer to <i>8-26 Sysmac Studio Option Settings</i> on page 8-166 for detail.

11-4 Error Messages for Sysmac Studio Operation

The following table lists the error messages that are displayed in the Output Tab Page when you perform operations on the Sysmac Studio.

Error message	Error level	Cause	Correction
□□□ cannot be executed.	Error	<ul style="list-style-type: none"> A cable is disconnected. 	<ul style="list-style-type: none"> Check the cable connections. Go offline and then go online again, and then try again. Increase the response monitoring time in the Communications Setup.
		<ul style="list-style-type: none"> You used prohibited characters in the volume label. 	<ul style="list-style-type: none"> Correct the volume label.
		<ul style="list-style-type: none"> You used prohibited characters when you created or renamed a file or folder. 	<ul style="list-style-type: none"> Correct the name of the file or folder.
		<ul style="list-style-type: none"> The SD Memory Card does not have enough available space for the copy operation. 	<ul style="list-style-type: none"> Check the amount of available space required to copy the data, and the amount of available space left on the SD Memory Card.
		<ul style="list-style-type: none"> There is no SD Memory Card. 	<ul style="list-style-type: none"> Insert the SD Memory Card.
		<ul style="list-style-type: none"> Power is not supplied to the SD Memory Card. 	<ul style="list-style-type: none"> Insert the SD Memory Card again.
		<ul style="list-style-type: none"> The protection switch on the SD Memory Card is turned ON. 	<ul style="list-style-type: none"> Turn OFF the protection switch on the SD Memory Card.
		<ul style="list-style-type: none"> A format operation is in progress. Other Support Software is currently accessing the SD Memory Card. 	<ul style="list-style-type: none"> Wait until the format operation is completed, and then try again. Wait until the other Support Software is finished, and then try again.

Error message	Error level	Cause	Correction
A communications error has occurred /The communication has been disconnected.	Error	There was a communications error between the Sysmac Studio and the Controller. (For example, a cable is disconnected.)	Check the Communications Setup, and then try again.
		There was an error in a communications message.	<ul style="list-style-type: none"> • Check the cable connections and go offline, then go online and try again. • Increase the response monitoring time in the communications settings. • Wait for a while and then try again (e.g., wait until downloads from other Support Software are completed).
		An unexpected error occurred during exclusive control of commands.	
		An unexpected error occurred (including inconsistent communications format).	
		A timeout occurred during the Communications Setup test.	Check the following items: <ul style="list-style-type: none"> • Cable connections • The specified IP address • The network connection and the IP address setting for the local area network in the Control Panel on the computer
		There was no response from the Controller.	<ul style="list-style-type: none"> • Make sure the cables are connected correctly. • Increase the response monitoring time in the Communications Setup. • Cycle the power supply to the Controller.
An error occurred when exporting the project.	Error	The file system is write protected, or some other write error occurred.	Make sure the write attribute of the file system is set correctly.
A project could not be found in the archive file.	Error	The export file was not found.	Specify the correct export file.
An error has occurred in the MC Test Run. The MC Test Run is forced to end.	Error	You cannot execute the operation because of a Controller error.	Identify and remove the Controller error, and then try again.
An error occurred while the Special Unit parameters were transferred.	Error	The transfer operation for all parameters timed out.	Check the power supply and wiring, and then try again.
An error occurred during backup parameter transfer of EtherCAT slaves.	Error	Refer to the error message.	Try again.
An error occurred when importing the project.	Error	The file system is read protected, or some other read error occurred.	Make sure the read attribute of the file system is set correctly.

Error message	Error level	Cause	Correction
Unexpected error occurred. *** aborted. /The *** processing was abnormally terminated due to an unexpected error.	Error	Refer to the error message.	Try again.
Cannot change to the MC Test Run.	Error	You cannot execute the operation because of a Controller error.	Identify and remove the Controller error, and then try again.
Cannot execute the test run.	Error	You cannot execute the operation because of a Controller error.	Identify and remove the Controller error, and then try again.
Cannot read the axis variable variable_name .	Error	There was a communications error between the Sysmac Studio and the Controller.	Check the Communications Setup, and then try again.
Cannot start monitoring the axis status.	Error	There was a communications error between the Sysmac Studio and the Controller.	Check the Communications Setup, and then try again.
CPU Unit write protection is set. Release the write protection, and then execute the transfer. Process was aborted.	Error	CPU Unit write protection is set.	Release CPU Unit write protection, and then perform the operation again.
Data is broken.	Error	The data you attempted to read or write is corrupted.	
Error occurred when exporting project	Error	The export failed due to some problem.	Make sure the contents of the file and the write attribute of the file system are correct.
Error occurred when importing project	Error	The import failed due to some problem.	Make sure the contents of the file and the read attribute of the file system are correct.
Error while loading file	Error	The file could not be loaded.	Check the file to see if it is corrupted.
Error while writing file	Error	The file could not be written to.	Make sure that the file is not open for any other application, and then try again.
Export Failed	Error	You cannot write to the save location. You do not have write rights for the save location. The file you are trying to overwrite may be in use by another application.	Save the data to a folder that you can write to. Save the file under another file name.
Failed to □□□ due to out of memory. Please restart Sysmac Studio and then try again.	Error	There is insufficient memory for Sysmac Studio processing.	Close the project, restart the Sysmac Studio, and execute the operation again.
Failed to add a Rack.	Error	You have reached the maximum number of Racks.	Delete a Rack, and then try again.
Failed to add a Unit.	Error	You have reached the maximum number of Units that you can add to the Rack.	Add the Unit to another Rack, or delete a Unit and try again.

Error message	Error level	Cause	Correction
Failed to clear the error.	Error	<p>A timeout occurred or an error response was received when you attempted to reset a Controller error or user-defined error during troubleshooting.</p> <ul style="list-style-type: none"> A cable is disconnected. You do not have the required access rights. A download is in progress for other Support Software. 	<ul style="list-style-type: none"> Check the cable connections. Go offline and then go online again, and then try again. Reset the access rights, and then try again. Wait until the download for the other Support Software is finished, and then try again.
Failed to clear diagnosis/statistics information.	Error	The system is busy.	Try again.
		The communications timed out.	Check the power supply and wiring, and then try again.
Failed to clear the event log.	Error	<p>A timeout occurred or an error response was received when you attempted to clear the troubleshooting event log or user-defined event log or when you attempted to clear all memory to clear the error log.</p> <ul style="list-style-type: none"> A cable is disconnected. You do not have the required access rights. Write protection is enabled. A download is in progress for other Support Software. 	<ul style="list-style-type: none"> Check the cable connections. Go offline and then go online again, and then try again. Increase the response monitoring time in the Communications Setup. Reset the access rights, and then try again. Release CPU Unit write protection, and then try again. Wait until the download for the other Support Software is finished, and then try again.
Failed to communicate with the EtherCAT slave or the NX Unit. Process was aborted.	Error	The system is busy.	Try again.
		The loads are OFF.	Enable the loads, and then try again.
		A major fault level Controller error occurred.	Correct the error, and then try again.
		A partial fault level Controller error such as a CPU Rack bus error occurred in a subsystem.	Correct the error, and then try again.
		A Link OFF Error occurred.	Check the power supply and wiring of the first slave and then try again.
		Communications are not possible with the target slave.	Check the power supply, wiring, and slave's node address, and then try again.
		The target slave is disabled.	Enable the slave and perform synchronization, and then try again.
		The slave cannot be identified.	Use the Compare and Merge with Actual Network Configuration menu command to make the configurations match, synchronize the data, and then try again.
		Synchronization has not been performed.	Synchronize the data, and then try again.

Error message	Error level	Cause	Correction
Failed to compare.	Error	The communications timed out.	Check the power supply and wiring, and then try again.
		The system is busy.	Try again.
		The loads are OFF.	Enable the loads, and then try again.
		A major fault level Controller error occurred.	Correct the error, and then try again.
		A Link OFF Error occurred.	Check the power supply and wiring of the first slave and then try again.
		Communications are not possible with the target slave.	Check the power supply, wiring, and slave's node address, and then try again.
		The target slave is disabled.	Enable the slave and perform synchronization, and then try again.
		The slave cannot be identified.	Use the Compare and Merge with Actual Network Configuration menu command to make the configurations match, synchronize the data, and then try again.
		Synchronization has not been performed.	Synchronize, and then perform the operation.
		A slave status change was detected.	Make sure you are not performing any operations in other Support Software, and then try again.
A change in the configuration was detected.	Try again.		
Failed to delete a Rack.	Error	You cannot delete this Rack.	
Failed to execute the command.	Error	You cannot execute the operation because of a Controller error.	Identify and remove the Controller error, and then try again.
Failed to extend the session.	Error	You cannot execute the operation because of a Controller error.	Identify and remove the Controller error, and then try again.
Failed to get a session.	Error	You cannot execute the operation because of a Controller error.	Identify and remove the Controller error, and then try again.
Failed to get actual Unit configuration.	Error	A change in the configuration was detected.	Try again.
		The limit to the number of slaves was exceeded.	Correct the wiring to reduce the number of slaves to 192 or less, and then try again.
		The wiring is incorrect.	Correct the wiring so that the input and output ports are connected, and then try again.
		The system is busy.	Try again.
		The communications timed out.	Check the power supply and wiring, and then try again.
		A Link OFF Error occurred.	Check the power supply of the first slave. Check the wiring. Try again after you have solved the problem.
		A system error occurred.	Contact your OMRON representative.

Error message	Error level	Cause	Correction
Failed to get diagnosis/statistics information.	Error	The communications timed out.	Check the power supply and wiring, and then try again.
Failed to get packet data.	Error	The communications timed out.	Check the power supply and wiring, and then try again.
		The system is busy.	Try again.
		The packet monitor was started already.	Stop the packet monitor, and then try again.
		The file could not be obtained.	Make sure that you are not saving the packet monitor results with an instruction or from another tool, and then try again.
Failed to get serial numbers.	Error	A change in the configuration was detected.	Try again.
		The limit to the number of slaves was exceeded.	Correct the wiring to reduce the number of slaves to 192 or less, and then try again.
		The wiring is incorrect.	Correct the wiring so that the input and output ports are connected, and then try again.
		The system is busy.	Try again.
		The communications timed out.	Check the power supply and wiring, and then try again.
		A Link OFF Error occurred.	Check the power supply of the first slave. Check the wiring. Try again after you have solved the problem.
		The actual device configuration and the device configuration in the project do not match.	Make sure that the device configurations match, and then try again.
Failed to get the Controller configuration information. Check the power supply and wiring for any abnormality, and retry.	Error	The configuration information of the CJ-series Units could not be obtained because of a communications error.	Check the status of the power supply and wiring, and then try the operation again.

Error message	Error level	Cause	Correction
Failed to get the production information.	Error	A change in the configuration was detected.	Try again.
		The limit to the number of slaves was exceeded.	Correct the wiring to reduce the number of slaves to 192 or less, and then try again.
		The communications timed out.	Check the power supply and wiring, and then try again.
		The wiring is incorrect.	Correct the wiring so that the input and output ports are connected, and then try again.
		The system is busy.	Try again.
		A Link OFF Error occurred.	Check the power supply of the first slave. Check the wiring. Try again after you have solved the problem.
		Check that the slave information on the right is provided in the ESI file library.	Vendor ID=0x{0,0:X8}, Product Code=0x{1,0:X8}, Revision Number=0x{2,0:X8}
		There are two or more slaves with the same node address in the actual device configuration.	Write a new slave node address to correct the problem.
		There is a slave with an out-of-range node address in the actual device configuration.	Write a new slave node address to correct the problem.
Communications failed.	Check the power supply and wiring, and then try again.		
Failed to judge the condition. Simulation will stop at the breakpoint.	Error	This error is displayed when the condition for a breakpoint cannot be evaluated due to an internal communications error. * This does not mean that the result of the evaluation is FALSE.	Execution pauses at the breakpoint where the error occurred, and this error message is displayed. Stop the simulation, and then execute the simulation again.
Failed to load the event log.	Error	A timeout occurred or an error response was received when reading the event log for troubleshooting. <ul style="list-style-type: none"> A cable is disconnected. A download is in progress for other Support Software. An I/O Bus Check Error occurred, and reading the error log of the CJ-series Unit was not possible. 	<ul style="list-style-type: none"> Check the cable connections. Go offline and then go online again, and then try again. Increase the response monitoring time in the Communications Setup. Wait until the download for the other Support Software is finished, and then try again. Eliminate all high level errors, perform an error reset, and then try to read the event log again.
Failed to lock the servo.	Error	You cannot execute the operation because of a Controller error.	Identify and remove the Controller error, and then try again.
Failed to monitor the status.	Error	You cannot execute the operation because of a Controller error.	Identify and remove the Controller error, and then try again.
Failed to read Controller Clock Information.	Error	A timeout occurred when the Clock Dialog Box was displayed. (For example, a cable is disconnected.)	<ul style="list-style-type: none"> Check the cable connections. Go offline and then go online again, and then try again.

Error message	Error level	Cause	Correction
Failed to read the file.	Error	You specified a file that is not a Unit Parameters File.	Specify a Unit Parameters File.
Failed to read the list of Controller variables and memory addresses for which forced refreshing is active.	Error	A timeout occurred or an error response was received when you attempted to read forced refreshing values after going offline, or when all forced refreshing was completed. <ul style="list-style-type: none"> A cable is disconnected. A download is in progress for other Support Software. 	<ul style="list-style-type: none"> Check the cable connections. Go offline and then go online again, and then try again. Increase the response monitoring time in the Communications Setup. Wait until the download for the other Support Software is finished, and then try again.
Failed to read the serial ID.	Error	The serial ID could not be obtained from the CPU Unit when online.	There is no correction to be taken. (For example, noise caused the error.)
Failed to read the status.	Error	You cannot execute the operation because of a Controller error.	Identify and remove the Controller error, and then try again.
Failed to cancel the forced refreshings for all of the specified variables/memory in the Controller.	Error	A timeout occurred or an error response was received when you attempted to cancel forced refreshing after going offline, or when all forced refreshing was completed. <ul style="list-style-type: none"> A cable is disconnected. A download is in progress for other Support Software. 	<ul style="list-style-type: none"> Check the cable connections. Go offline and then go online again, and then try again. Increase the response monitoring time in the Communications Setup. Wait until the download for the other Support Software is finished, and then try again.
Failed to reset all axis errors.	Error	You cannot execute the operation because of a Controller error.	Identify and remove the Controller error, and then try again.
Failed to restore EtherCAT configuration.	Error	Add an ESI file that contains the device (ID) information.	Make sure that the device configurations match, and then try again.
Failed to save file.	Error	You do not have the rights that are required to load the file.	
Failed to save the build results to the project due to out of memory. Please restart Sysmac Studio, and then execute the build again.	Error	There is insufficient memory for Sysmac Studio processing.	Close the project, restart the Sysmac Studio, and then build the programs before you transfer them to the Controller.
Failed to start absolute positioning.	Error	You cannot execute the operation because of a Controller error.	Identify and remove the Controller error, and then try again.
Failed to start homing.	Error	You cannot execute the operation because of a Controller error.	Identify and remove the Controller error, and then try again.
Failed to start jogging.	Error	You cannot execute the operation because of a Controller error.	Identify and remove the Controller error, and then try again.
Failed to start packet monitoring.	Error	The communications timed out.	Check the power supply and wiring, and then try again.
	Error	The system is busy.	Try again.
Failed to start relative positioning.	Error	You cannot execute the operation because of a Controller error.	Identify and remove the Controller error, and then try again.
Failed to start the MC Test Run.	Error	You cannot execute the operation because of a Controller error.	Identify and remove the Controller error, and then try again.
Failed to stop jogging.	Error	You cannot execute the operation because of a Controller error.	Identify and remove the Controller error, and then try again.

Error message	Error level	Cause	Correction
Failed to stop packet monitoring.	Error	The communications timed out.	Check the power supply and wiring, and then try again.
	Error	The system is busy.	Try again.
Failed to stop the axis.	Error	You cannot execute the operation because of a Controller error.	Identify and remove the Controller error, and then try again.
Failed to transfer to the controller.	Error	The upload failed (the specified file does not exist).	
Failed to transfer the parameters.	Error	There was a communications error between the Sysmac Studio and the Controller.	Check the Communications Setup, and then try again.
Failed to transfer from the controller.	Error	The download failed.	
Failed to transfer.	Error	The communications timed out.	Check the power supply and wiring, and then try again.
		The system is busy.	Try again.
		The loads are OFF.	Enable the loads, and then try again.
		A major fault level Controller error occurred.	Correct the error, and then try again.
		A Link OFF Error occurred.	Check the power supply and wiring of the first slave and then try again.
		Communications are not possible with the target slave.	Check the power supply, wiring, and slave's node address, and then try again.
		The target slave is disabled.	Enable the slave and perform synchronization, and then try again.
		The slave cannot be identified.	Use the Compare and Merge with Actual Network Configuration menu command to make the configurations match, synchronize the data, and then try again.
		Synchronization has not been performed.	Synchronize, and then perform the operation.
		A slave status change was detected.	Make sure you are not performing any operations in other Support Software, and then try again.
Failed to transfer the EtherNet/IP connection settings to/from the Controller. (Communication Error)	Error	Communications were blocked due to Windows firewall settings.	Change the Windows firewall settings to allow access. Refer to the <i>NJ/NX-series CPU Unit Built-in EtherNet/IP Port User's Manual (Cat. No. W506)</i> or <i>NY-series Industrial Panel PC / Industrial Box PC Built-in EtherNet/IP Port User's Manual (Cat. No. W563)</i> for details.
Failed to unlock the servo.	Error	You cannot execute the operation because of a Controller error.	Identify and remove the Controller error, and then try again.

Error message	Error level	Cause	Correction
Failed to write Controller Clock Information.	Error	A timeout occurred when you clicked the button to apply the time zone and clock settings in the Clock Dialog Box. (For example, a cable is disconnected.)	<ul style="list-style-type: none"> Check the cable connections. Go offline and then go online again, and then try again.
Failed to write the Controller name.	Error	<p>A timeout occurred or an error response was received when you attempted to write the name of the Controller while online.</p> <ul style="list-style-type: none"> A cable is disconnected. Write protection is enabled. A download is in progress for other Support Software. 	<ul style="list-style-type: none"> Check the cable connections. Go offline and then go online again, and then try again. Increase the response monitoring time in the Communications Setup. Release CPU Unit write protection, and then try again. Wait until the download for the other Support Software is finished, and then try again.
Failed to write the ID to the Controller.	Error	<p>A timeout occurred or an error response was received when you attempted to write the online user program execution ID to the Controller.</p> <ul style="list-style-type: none"> A cable is disconnected. RUN mode Write protection is enabled. A download is in progress for other Support Software. 	<ul style="list-style-type: none"> Check the cable connections. Go offline and then go online again, and then try again. Increase the response monitoring time in the Communications Setup. Change to PROGRAM mode, and then try again. Release CPU Unit write protection, and then try again. Wait until the download for the other Support Software is finished, and then try again.
File operation failed.	Error	Refer to the error message.	
Import Failed	Error	The CSV file is corrupted. Another application is using the CSV file.	If another application is using the CSV file, close that application, and then try again.
Incorrect CSV format on line line_number .	Error	The CSV file format is incorrect.	Specify a valid CSV file.
Insufficient permissions.	Error	You do not have the read rights required to read the file system stored in the project file.	Make sure the read attribute of the file system is set correctly.
One of the modules for executing Sysmac Studio stopped. Exit Sysmac Studio and try again.	Error	For some reason, one of the modules for executing Sysmac Studio stopped.	Restart the Sysmac Studio and then execute the operation again.
Problem while reading CSV File	Error	The CSV file could not be loaded.	Make sure that the file is not open for any other application, and then try again.
Sysmac Studio cannot be started because one or more system files are missing. Please uninstall the Sysmac Studio, and then reinstall it.	Error	A file that is necessary to start the Sysmac Studio is missing.	Uninstall the Sysmac Studio and then install it again.
The command is not supported by the controller and device.	Error	The command does not exist.	

Error message	Error level	Cause	Correction
The comparison processing could not start.	Error	<ul style="list-style-type: none"> The backup file is corrupted. The data that is required for comparison is not in the backup file. 	Make sure that the file is correct and execute the operation again.
The content of the archive file is invalid.	Error	The contents of the export file are incorrect (format error).	Specify the correct export file.
The Controller was not found.	Error	A node at the specified IP address was not found during the Communications Setup test. (A response was received, but the specified IP address was not found.)	<ul style="list-style-type: none"> Check the remote IP address in the Communications Setup.
The data of rung No. □□ is corrupted. Delete the rung No. □□ and create it again.	Error	The rung data was corrupted for some reason.	Delete the corrupted rung and create it again.
The entered value has an error.	Error	The value that was entered in one or more of the text boxes in the current window is out of range.	You can view the tooltip of any text box with an exclamation mark to see how to correct the problem. Follow the instructions to correct the value as appropriate.
The file format is illegal.	Error	Refer to the error message.	
The name has already been used.	Error	A data type with that name is already defined.	Use a different name to define the data type.
The operation cannot be executed because it is invalid.	Error	Refer to the error message.	
The predefined keywords cannot be used for data type name.	Error	This error is displayed when you attempt to use a reserved word (such as IF) for a data type name.	Do not use reserved words for data types.
The system file could not be loaded. Please restart Sysmac Studio and then try again.	Error	A file that is necessary to start the Sysmac Studio cannot be read.	Restart the Sysmac Studio.
The target controller includes data not supported by the current version of Sysmac Studio. Use the latest version of Sysmac Studio.	Error	An attempt was made to connect to a Controller with an unsupported unit version.	Use the newest version of the Sysmac Studio.
		An NX Unit that is not supported is included in the EtherCAT Slave Terminal configuration information in the connected Controller.	Use the newest version of the Sysmac Studio.
The target controller includes data of functions that cannot be used in Sysmac Studio.	Error	If <i>Library Data</i> is also displayed, a library in the Controller data was created with a version of Sysmac Studio that is newer than the version that is currently online.	Use the newest version of the Sysmac Studio.
		The Controller includes a library not supported by the current version of Sysmac Studio.	Use the newest version of the Sysmac Studio.



Appendices

A-1	Driver Installation for Direct USB Cable Connection.....	A-3
A-1-1	Installing the USB Driver	A-3
A-1-2	Installing a Specified USB Driver	A-3
A-1-3	Installing NA5-□□W□□□□-V2 USB Driver.....	A-5
A-1-4	Confirmation Procedure after Installation	A-10
A-2	Specifying One of Multiple Ethernet Interface Cards	A-11
A-3	Network Browser Tool	A-13
A-4	Differences between the Simulator and the Physical Controller.....	A-15
A-4-1	Operation of Functions	A-15
A-4-2	Task Execution	A-18
A-4-3	Task Execution Times.....	A-21
A-4-4	Floating-point Data Expressions	A-22
A-5	Online Help	A-23
A-5-1	Sysmac Studio Help Contents.....	A-23
A-5-2	Instruction Reference	A-23
A-5-3	Keyboard Mapping Reference.....	A-24
A-5-4	System Defined Variable Reference	A-24
A-6	Shortcut Keys	A-25
A-6-1	Basic Operations	A-25
A-6-2	Editing Programs.....	A-26
A-6-3	Searching and Replacing	A-27
A-6-4	Online	A-27
A-6-5	Simulation.....	A-28
A-6-6	SD Memory Card.....	A-28
A-6-7	Changing Shortcut Keys.....	A-29
A-7	Simulation Instructions	A-38
A-7-1	Simulate Positive Limit Input Signal Instruction.....	A-38
A-7-2	Simulate Negative Limit Input Signal Instruction	A-39
A-7-3	Simulate Home Proximity Signal Instruction	A-42
A-7-4	Simulate Immediate Stop Input Signal Instruction.....	A-43
A-7-5	Simulate External Latch Input Signal Instruction	A-44
A-7-6	Simulate Drive Alarm Instruction	A-46
A-7-7	Simulate Drive Warning Instruction	A-47
A-7-8	Encoder Velocity Input Instruction	A-48
A-7-9	Write Actual Position Instruction.....	A-50
A-7-10	Write Actual Velocity Instruction	A-52
A-7-11	Write Actual Torque Instruction	A-54
A-7-12	Detailed Information on Error Codes	A-56

A-8	Directly Connecting to an EtherCAT Slave Terminal	A-59
A-8-1	Procedure for Directly Connecting to an EtherCAT Slave Terminal	A-59
A-8-2	Transferring Settings for an EtherCAT Slave Terminal	A-60
A-8-3	Comparing the EtherCAT Slave Terminal Configuration Information	A-61
A-8-4	USB Connection Prohibition Setting for EtherCAT Slave Terminals	A-61
A-8-5	I/O Wiring Checks for EtherCAT Slave Terminals	A-62
A-8-6	Differences in Operation from an Online Connection to an NJ/NX/NY-series Controller	A-63
A-9	MDP Settings for EtherCAT Network Slaves	A-64
A-9-1	Installing ESI Files for MDP Slaves	A-64
A-9-2	Adding MDP Slaves	A-64
A-9-3	Editing Module Configurations	A-64
A-9-4	Building Module Configurations Online	A-65
A-9-5	Setting MDP Slaves and Transferring/Comparing Module Configurations...	A-65
A-9-6	Displaying Production Information.....	A-65
A-10	Changing the Sysmac Studio Display Language.....	A-67
A-10-1	Changing the Display Language	A-67
A-11	Changing models among NJ-, NX-, and NY-series Controllers	A-68
A-11-1	Changing between NJ-series and NX701 Controllers	A-69
A-11-2	Changing between NJ-series and NY-series Controllers	A-70
A-11-3	Changing between NY-series and NX701 Controllers.....	A-72
A-11-4	Changing between NX1P2 and NJ-series Controllers	A-73
A-11-5	Changing between NX1P2 and NX701 Controllers.....	A-75
A-11-6	Changing between NX1P2 and NY-series Controllers	A-77
A-11-7	Changing between NX102 and NJ-series Controllers	A-78
A-11-8	Changing between NX102 and NX701 Controllers	A-80
A-11-9	Changing between NX102 and NY-series Controllers.....	A-81
A-11-10	Changing between NX102 and NX1P2 Controllers.....	A-83
A-11-11	Changing between NX502 and NJ-series Controllers.....	A-84
A-11-12	Changing between NX502 and NX701 Controllers	A-86
A-11-13	Changing between NX502 and NY-series Controllers.....	A-88
A-11-14	Changing between NX502 and NX102 Controllers	A-89
A-11-15	Changing between NX502 and NX1P2 Controllers.....	A-91
A-12	Report Tools	A-92
A-12-1	Sysmac Controller Log Upload Tool	A-92
A-12-2	Sysmac Studio Error Report Generating Tool	A-94
A-12-3	Sysmac Coupler Log Upload Tool	A-95
A-13	Downloading Manuals	A-97
A-13-1	Displaying the Manual Download Site.....	A-97

A-1 Driver Installation for Direct USB Cable Connection

This section describes the procedures when you connect the computer to the USB port on the Controller, Communications Coupler Unit, or NA-series PT the first time, assuming that you are using Windows 7.

These procedures assume that the Sysmac Studio is already installed on the computer.

A-1-1 Installing the USB Driver

- 1 Turn ON the power supply to the Controller, Communications Coupler Unit, or HMI and connect the USB port on it with a USB cable.

The USB driver is installed automatically after you connect the cable.

Note that when using NA5-□□W□□□□-V2, the USB driver will not be installed automatically. Refer to *A-1-3 Installing NA5-□□W□□□□-V2 USB Driver* on page A-5 for details.



Additional Information

You may need to restart Windows after you install the USB driver. Restart Windows as instructed on the display.

A-1-2 Installing a Specified USB Driver

If you cannot install the USB driver automatically, use the following procedure to specify the driver to install.

- 1 Start the **Device Manager** from the Control Panel and, in **Other devices**, double-click **Unknown device**.

The **Unknown device Properties** dialog box is displayed.

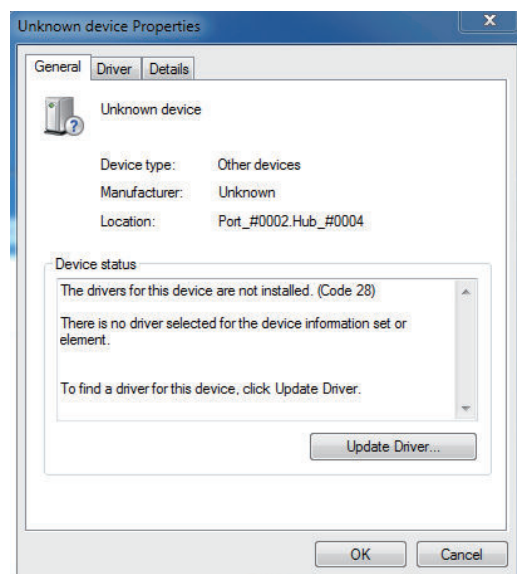

- Click the **Update Driver** Button.
The **Update Driver Software** Dialog Box is displayed.

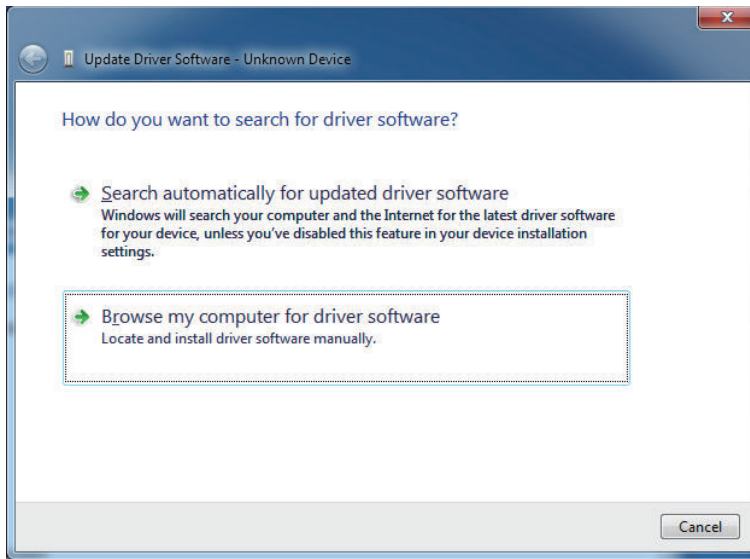

- Click **Browse my computer for driver software**.
A dialog box is displayed to specify the location to browse for driver software.

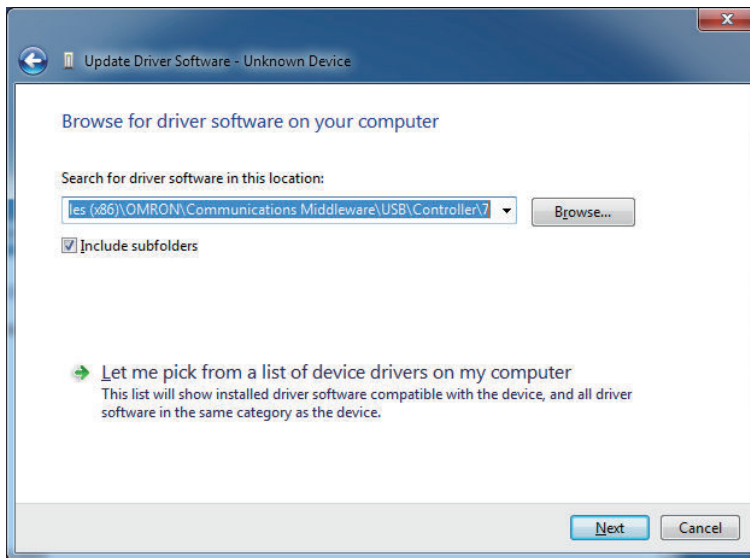

- Click the **Browse** Button and select the USB driver.
You can find the USB driver in the following location:
Folder paths for a Controller or HMI (NA5-□□□□□□) are shown below. For a Communications Coupler Unit, replace *Controller* with *Coupler*.
 - Windows 7 32-bit edition, Windows 8.1 32-bit edition, or Windows 10 32-bit edition
C:\Program Files\OMRON\Communications Middleware\USB\Controller\7\32bit
 - Windows 7 64-bit edition, Windows 8.1 64-bit edition, Windows 10 64-bit edition, or Windows 11 64-bit edition
C:\Program Files (x86)\OMRON\Communications Middleware\USB\Controller\7\64bit
 Folder paths for an HMI (NA5-□□W□□□□-V1) are shown below.
 - Windows 7 32-bit edition

- C:\Program Files\OMRON\Communications Middleware\USB\NA5-V1\7\32bit
- Windows 8.1 32-bit edition
- C:\Program Files\OMRON\Communications Middleware\USB\NA5-V1\8\32bit
- Windows 10 32-bit edition
- C:\Program Files\OMRON\Communications Middleware\USB\NA5-V1\10\32bit
- Windows 7 64-bit edition
- C:\Program Files(x86)\OMRON\Communications Middleware\USB\NA5-V1\7\64bit
- Windows 8.1 64-bit edition
- C:\Program Files(x86)\OMRON\Communications Middleware\USB\NA5-V1\8\64bit
- Windows 10 64-bit edition or Windows 11 64-bit edition
- C:\Program Files(x86)\OMRON\Communications Middleware\USB\NA5-V1\10\64bit

5 Click the **Next** Button.
The **Windows Security** Dialog Box is displayed.

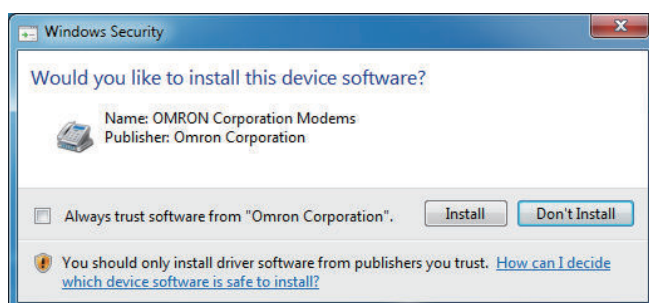

6 Click the **Install** Button.
When installation of the USB driver is completed, the following dialog box is displayed.

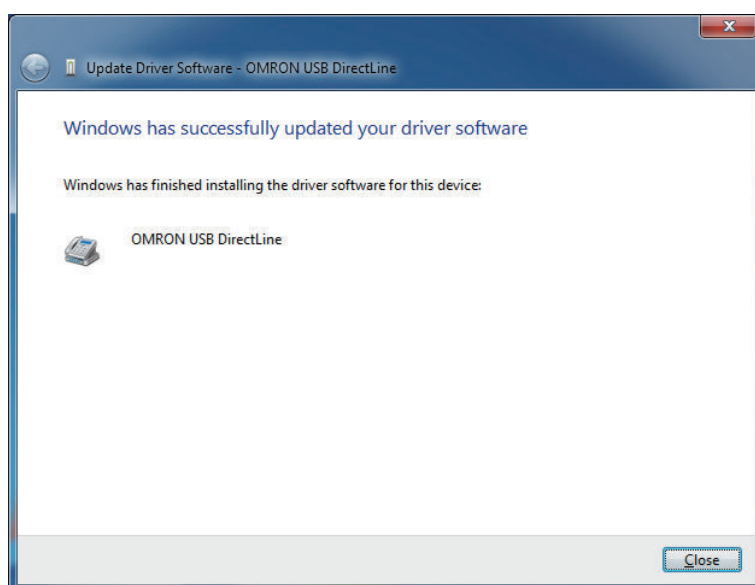

A-1-3 Installing NA5-□□W□□□□-V2 USB Driver

Use the following procedure to install NA5-□□W□□□□-V2 USB Driver.

- 1 Access the Microsoft® Update Catalog site and search for *USB RNDIS Gadget*.
When multiple drivers are found, select the following driver.

Acer Incorporated. - Other hardware - USB Ethernet/RNDIS Gadget

Refer to <https://www.catalog.update.microsoft.com/Home.aspx> for information on the Microsoft® Update Catalog site.

- 2 Download the appropriate driver for your environment.
Click the download button for **Windows 7, Windows 8, Windows 8.1 and later drivers**.
Clicking the download button displays a download window. Click the cab file link to download the cab file.



Additional Information

Note that when using 32-bit Windows, transferring the system program from Sysmac Studio is not supported. To update the system program, it is required to execute the system recovery. For details on the system recovery, refer to the *NA-series Programmable Terminal Hardware (-V2) User's Manual (Cat. No. V128)*.

- 3 Extract the downloaded cab file.
Right-click the cab file and select **Open** from the menu.

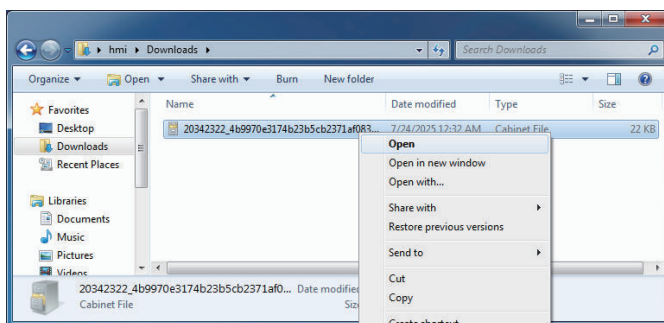

Two files are displayed. Right-click these files and select **Extract** from the menu.

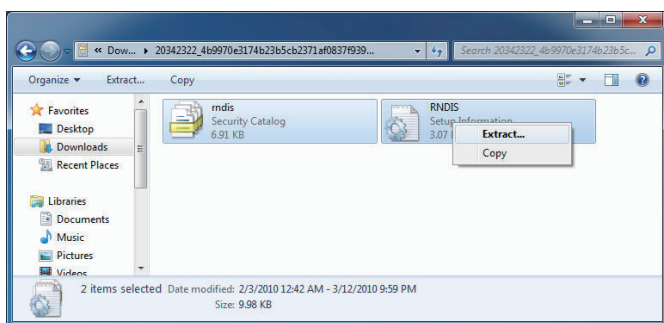

In the **Select a Destination** Dialog Box, select the destination folder for extracted files and click the **Extract** Button.

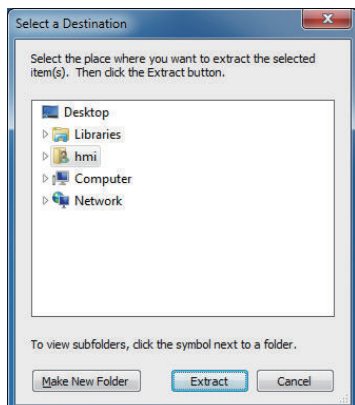

If the **File Download – Security Warning** Dialog Box appears, click the **Save** Button to save the file.

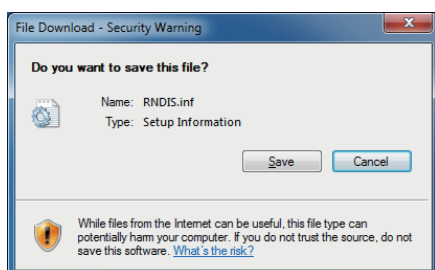

- 4 Open the extracted folder and check that the following files are present. Make sure that these are **Security Catalog** and **Setup Information** files.

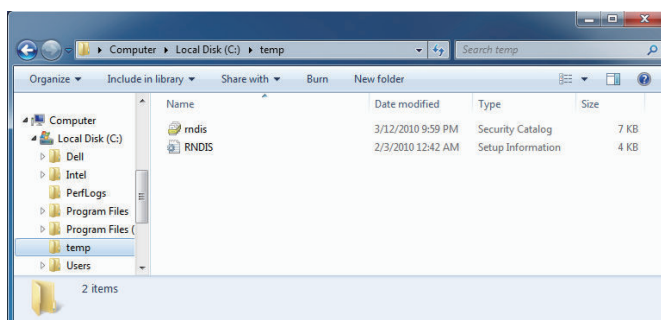

- 5 Start the **Device Manager** from the Control Panel and double-click **RNDIS/Ethernet Gadget** under **Other devices**. The **RNDIS/Ethernet Gadget Properties** Dialog Box is displayed.

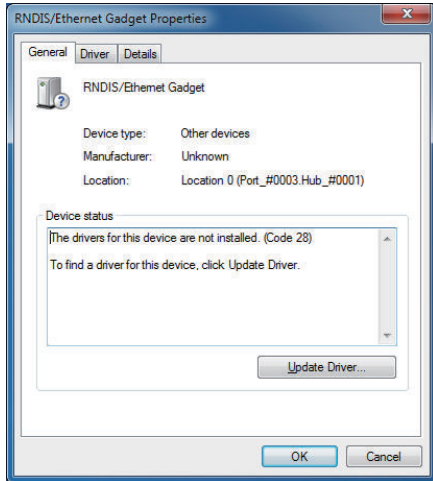

- 6 Click the **Update Driver** Button.
The **Update Driver Software** Dialog Box is displayed.

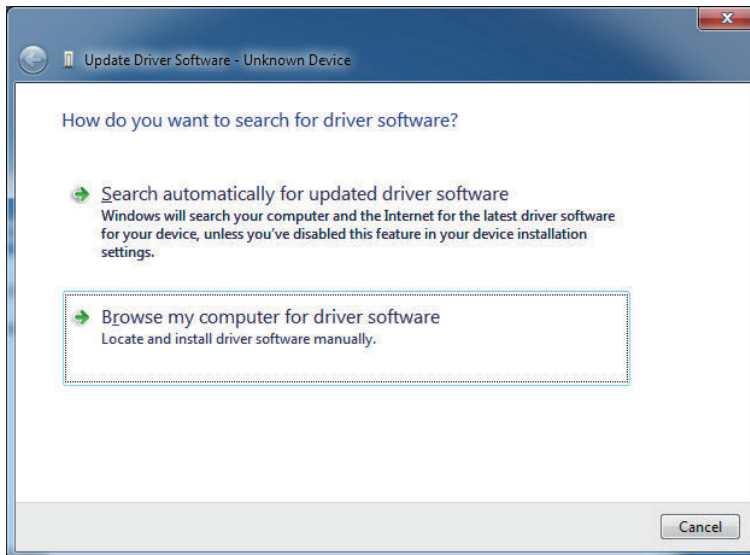

- 7 Click **Browse my computer for driver software**.
A dialog box is displayed to specify the location to browse for driver software.

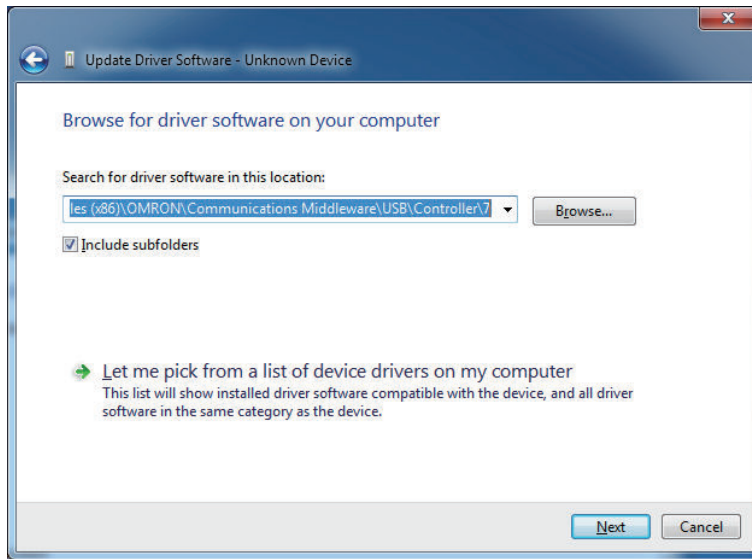

8 Click the **Browse** button and select the folder with the files that you extracted in step 3.

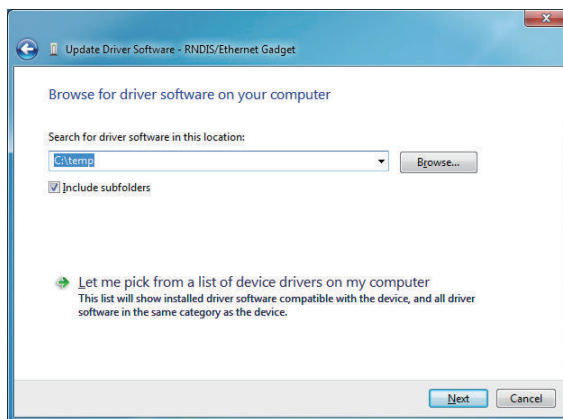

9 Click the **Next** Button.

If the **Windows Security** installation warning message appears, click the **Install** Button and continue with the installation.

When installation of the USB driver is completed, the following dialog box is displayed.

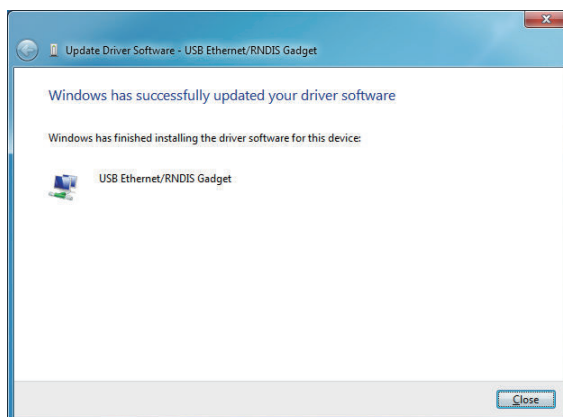

A-1-4 Confirmation Procedure after Installation

● Procedure

- 1** Connect the computer to the Controller, Communications Coupler Unit, or HMI with a USB cable.
- 2** Start the Device Manager on the computer.
- 3** In the Device Manager, make sure that the following name is displayed.
For Controller or HMI (NA5-□□□□□□): OMRON USB DirectLine
For Communications Coupler Unit: OMRON USB AbstractControl
For HMI (NA5-□W□□□□-V1): NA5 V1 USBClient
For HMI (NA5-□W□□□□-V2): USB Ethernet/RNDIS Gadget
Example for Controller or HMI (NA5-□□□□□□)

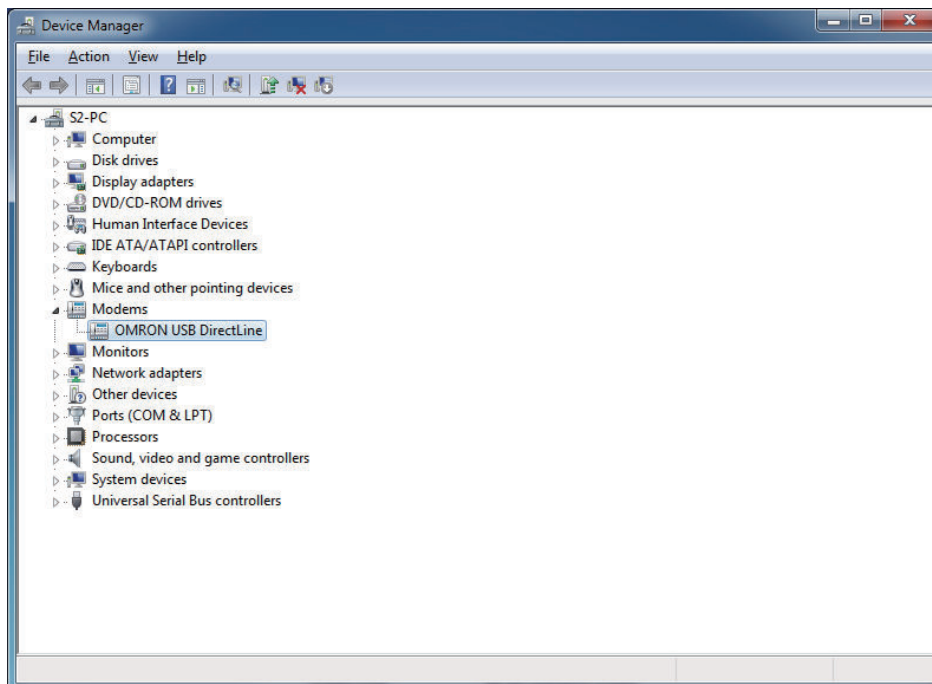

A-2 Specifying One of Multiple Ethernet Interface Cards

If more than one Ethernet interface card is mounted in the computer that runs the Sysmac Studio, you must specify the Ethernet interface card that is connected to the NJ/NX/NY-series Controller to connect directly through Ethernet.

The Ethernet interface card is specified when the Sysmac Studio is installed. You can use a special utility shown below to change the specification after installation.

Specifying the Ethernet Interface Card

- 1 Select **All Programs - OMRON - Communications Middleware Utilities - Direct Ethernet Utility** from the Windows Start Menu.
The Direct Ethernet Utility Dialog Box is displayed.
- 2 Select the Ethernet interface card to use to connect the NJ/NX/NY-series Controller in the Direct Ethernet Utility Dialog Box.

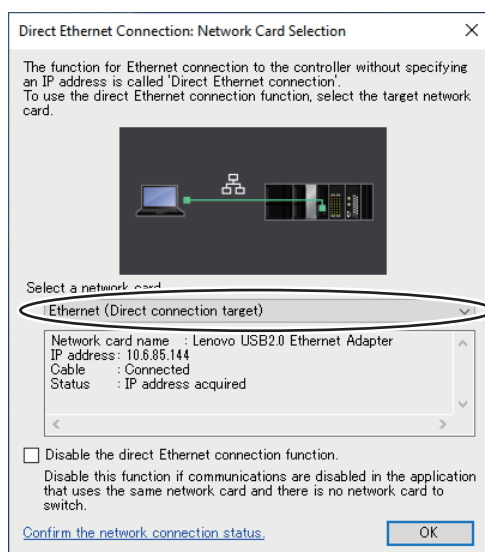

- 3 Click the **OK** Button. The dialog box is closed.



Precautions for Correct Use

If any other application that uses the same network becomes unable to communicate and there is no network card to switch, select the **Disable the direct Ethernet connection function** Check Box and disable this feature.

- Disable the direct Ethernet connection function.**
Disable this function if communications are disabled in the application that uses the same network card and there is no network card to switch.



Precautions for Correct Use

The settings that you make with the Direct Ethernet Utility are used for Ethernet connections for other OMRON software as well, not just for the Sysmac Studio. Make sure that you do not unintentionally change the connected Controller when you change the Ethernet interface card.

Examples of other OMRON software: Network Configurator and CX-Integrator

A-3 Network Browser Tool





From the computer on which the Sysmac Studio is installed, you can check the connection status with multiple Controllers. In addition, if the Sysmac Studio cannot go online with a Controller, you can collect useful information for troubleshooting from the browse result displayed in this tool.

● Using the Network Browser

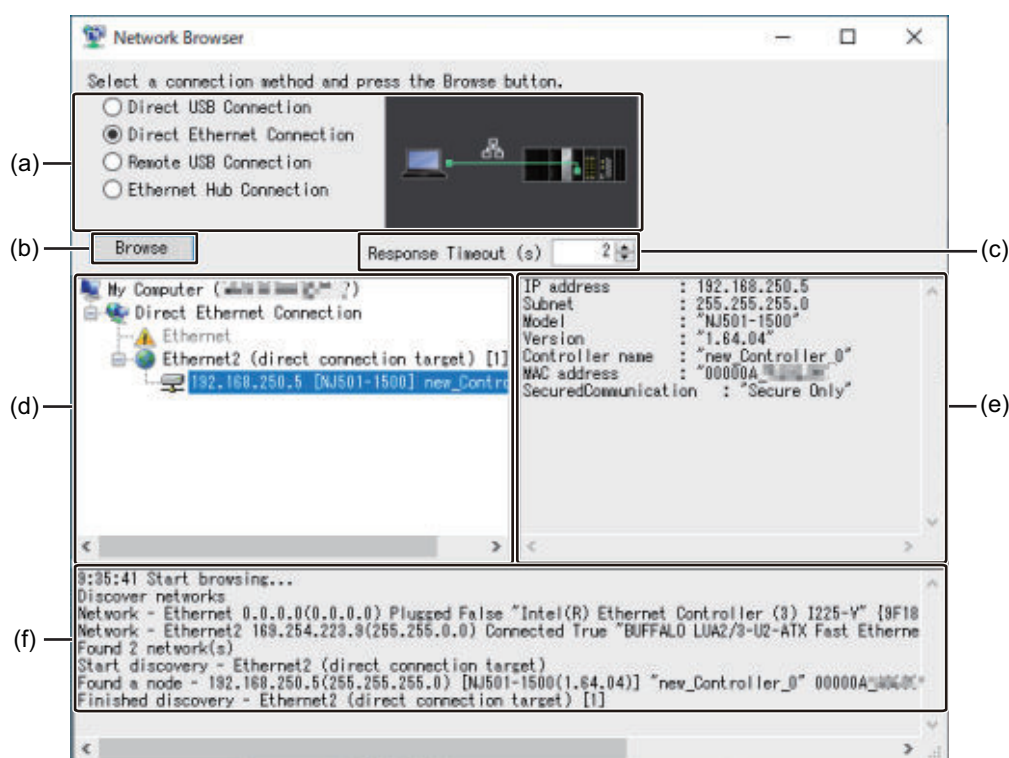
- 1 Select **All Programs – OMRON – Communications Middleware Utilities – Network Browser** from the Windows Start Menu.
The **Network Browser** Dialog Box is displayed.
- 2 Select a connection method and then click the **Browse** Button.



No.	Item	Description
(a)	Connection method	Select the connection method to use to go online.
(b)	Browse Button	Use this button to browse for multiple Controllers connected to the computer using the connection method selected in (a).
(c)	Response Timeout	You can set the response monitoring time for communications with the Controller. An error is displayed if a response is not received before this time expires. <ul style="list-style-type: none"> • The time can be set to between 1 and 3,600 s.
(d)	Browse result	A tree of networks and nodes is displayed as the browse result.

No.	Item	Description
	Icons	 Indicates that the tool has successfully obtained network information but cannot browse it. Example: <ul style="list-style-type: none"> When Ethernet Hub Connection is selected as the connection method, the computer's network adapter is configured to Obtain an IP address automatically and no IP address is assigned. When Direct Ethernet Connection is selected as the connection method, the network card to be directly connected is disabled. Check the status of the network card in the network connection settings of Windows.
		 Indicates that the tool has failed to obtain network information. Example: When Remote USB Connection is selected as the connection method, no Controller is connected via USB cable.
(e)	Detailed network/node information	Detailed information on the network or node selected in (d) is displayed. If browsing is successful, the tool displays the following Controller information.
	IP address*1	Displays the IP address of the port connected to the computer.
	Subnet*1	Displays the subnet mask of the port connected to the computer.
	Model	Displays the Controller model.
	Version	Displays the firmware version.
	Controller name	Displays the name of the Controller.
	MAC address	Displays the MAC address of the Controller.
	SecuredCommunication*1	Displays the status of the Controller's DIP switch settings for secure communications. *2 These items are not displayed if the Controller does not support secure communications.
	Unuse	Secure communications are disabled.
	Secure Only	Secure communications are enabled.
(f)	Log display	Displays the log of the browse processing.

*1. These items are not displayed when **Direct USB Connection** is selected in **Connection method**.

*2. Refer to the *NJ-series CPU Unit Hardware User's Manual (Cat. No. W500)*, *NX-series CPU Unit Hardware User's Manual (Cat. No. W535)*, *NX-series NX502 CPU Unit Hardware User's Manual (Cat. No. W629)*, *NX-series NX102 CPU Unit Hardware User's Manual (Cat. No. W593)*, or *NX-series NX1P2 CPU Unit Hardware User's Manual (Cat. No. W578)* for details on the Controller's DIP switch settings for secure communications.



Additional Information

You can start the Network Browser tool also from the **Communication Setup** Dialog Box or the **Connect to Device** Dialog Box. Refer to 6-2-2 *Setting the Connection Method* on page 6-5 or 6-2-8 *Going Online without a Project* on page 6-9 for details.

A-4 Differences between the Simulator and the Physical Controller

A-4-1 Operation of Functions

The Simulator has the following functional differences in comparison with the physical Controller.

	Item	Differences between Simulator and physical Controller
Tasks	Starting	You start the Simulator from the Simulation Menu or the Simulation Pane. (You cannot start it from the Controller Menu.)
	Synchronization	The data in the Simulator is synchronized when you go online with the Simulator. (There is no need to perform synchronization after you start the Simulator.)
	Exiting	You exist the Simulator from the Simulation Menu or the Simulation Pane. (When you exist, the online connection is broken and the programs and other data are deleted from the Simulator.)
	Scheduling	<p>On the Simulator, tasks are executed according to the Windows scheduling policy. Task priority and timing are ignored, so operation is not necessarily the same as on the physical Controller. If a simulation is executed in Execution Time Estimate Mode, timeouts will not occur even for programs that are not completed within the specified timeout time, i.e., execution of those programs will continue. When execution is completed, a <i>Task Execution Timeout</i> minor fault will occur. (On the Controller, a timeout will occur, resulting in a major fault.)</p> <p>This allows you to check the estimated execution time of a program that does not complete execution within the timeout time.</p> <p>For details on the differences in the overall operation of tasks and the task execution times, refer to <i>A-4-2 Task Execution</i> on page A-18 and <i>A-4-3 Task Execution Times</i> on page A-21 later in this appendix.</p> <p>In an NX701 Controller, the primary periodic task and priority-5 periodic task are executed in parallel. On the Simulator, this type of parallel processing is not performed. The primary periodic task and priority-5 periodic task are executed sequentially.</p>
	Clock	<p>The time on the Simulator is different from the time in the operating system. The time on the Simulator is advanced by adding the time required by the control period each time the primary periodic task is executed.</p> <p>Temporarily stopping the programs or performing step execution will not affect the execution of timers or the operation of programs that access the time.</p>
	Monitoring	The Simulator displays the estimated execution times for operation on the physical Controller, and not the execution times on the computer.
	Resetting	<p>The Simulator does not provide a reset function. If you restart the Simulator, all POU instances are initialized except for retained variables.</p> <p>If you want to initialize retained variables, restart the Sysmac Studio.</p>

Item		Differences between Simulator and physical Controller
Variables and memory	Monitoring present values	The Simulator uses non-synchronized operation to read and write data. This creates the following functional differences in comparison with the physical Controller. <ul style="list-style-type: none"> Changes to the present values of variables on the I/O Map are not always possible on the physical Controller, but they are always possible on the Simulator. If program inputs for which forced refreshing is specified are changed in the user program, they may flicker on the monitor displays on the Simulator.
	Data on the Simulator	Variable data is valid only while the Simulator is running. The user program and all other data in the Simulator are cleared when you exit the Simulator.
	Retain attribute	If you stop a simulation on the Simulator and then perform any of the following operations, the values of retained variables are initialized when the simulation is started again. <ul style="list-style-type: none"> Change the project. Change the model or unit version. Edit the configurations, setups, or programs. However, if you start the simulation again without editing the configurations, setups, or programs, the values of retained variables are retained regardless of the operating mode when you start the simulation.
	Clear All Memory	This function is not supported by the Simulator. (Exit the Simulator and then go online with the Simulator again to clear memory.)
Debugging	Using the debugger	You can use debugger functions, such as step execution and breakpoints, on the Simulator.
	Changing the execution speed	You can change the apparent program execution times on the Simulator. (You change the program execution interval on the computer to change the apparent execution speed.) Time passage on the Simulator is not affected by changes in the execution speed.
	Debug programs	You can load and execute programs that are set as debug programs only on the Simulator. (You cannot load debug programs on the physical Controller.)
	Partial execution of user program	On the Simulator, you can specify to execute only the selected programs. (This is not possible on the physical Controller.)
Motion control	Axis control	If a Servo axis is specified on the Simulator, Servo operation is emulated. If an encoder axis is specified, you can control the axis with the Simulator instructions.
	Position and velocity control	On the Simulator, command values for the axes are used directly as the actual positions and actual velocities.
	Torque control	The Simulator does not have mechanical machine information and cannot calculate velocities for torque control. A velocity of 0 is used as the actual velocity.
	Touch probe function	With the Simulator, you can use Simulator instructions in the debug program to generate external triggers. On the Simulator, the Z phase is generated once for each 2,048 pulses that are input.
	MC Test Run	You cannot perform an MC Test Run when connected to the Simulator.
	Cam data	The cam data file transfer commands to transfer cam data from the Controller to files or from files to the Controller are not supported on the Simulator.
Networks	Setting communications addresses	Network communications are not performed by the Simulator, so communications address settings are ignored.
	Routing tables	Network communications are not performed by the Simulator, so routing table settings are ignored.
CJ-series Unit management	Unit configuration	The Simulator uses registered I/O directly as real I/O.
	First addresses for slots	The Simulator ignores the first address settings for slots.
	CJ-series Unit settings	CJ-series Unit emulation is not performed by the Simulator, so CJ-series Unit settings are ignored.

	Item	Differences between Simulator and physical Controller
Instructions	Communications instructions	The Simulator will normally process signal outputs for communications instructions, but it will not execute actual communications for the instructions. If you execute a serial communications instruction (ExecPMCR, SendCmd, SerialRcv, or SerialSend), an error (error ID: 0415) is output.
	EtherNet/IP communications instructions	The Simulator will normally complete the signal output processing for the FTP client communications instructions (FTPGetFileList, FTPGetFile, FTPPutFile, FTPRemoveFile, and FTPRemoveDir), but it will not execute FTP command processing for these instructions.
	EtherCAT communications instructions	The Simulator will not operate correctly for the following instructions. • EC_StopMon The instruction is processed normally, but the <code>_EC_PktMonStop</code> external variable remains FALSE. • EC_SaveMon The instruction is processed normally, but the <code>_EC_PktSaving</code> external variable remains FALSE. • EC_CopyMon Even if the file that is specified in the instruction exists, a File Does Not Exist error (error ID: 1403) is output and the instruction ends in an error.
	SD Memory Card instructions	You can use the SD Memory Card instructions on the Simulator in the same way as you can on the physical Controller. The Simulator uses "c:\OMRON\Data\SimulatorData\CARD\Memory001" as a Virtual SD Memory Card. However, for the BackupToMemoryCard instruction, signal output processing for the instruction is completed normally, but the backup files are not created in the Virtual SD Memory Card.
	Integer calculations	On the Simulator, if underflow or overflow occurs in integer or duration calculations, the calculation results may differ.
	Real data and conversion instructions	You can use the instructions on the Simulator in the same way as you can on the physical Controller. Rounding error for calculations on the Simulator may produce somewhat different calculation results. Expressions for infinity and nonnumeric data are sometimes different for the results of the Natural Exponential Operation (EXP) instruction or calculation results on the Simulator. For details, refer to <i>Expressions for Infinity and Nonnumeric Data in Real Number-to-Text String Conversion Instructions</i> on page A-22 later in this appendix.
	Clock instructions	The Simulator will normally complete signal output processing for clock and time instructions, but it will not execute time change processing for the instructions.
Maintenance	ID information	The Simulator does not have production information (i.e., ID information, such as lot numbers).
	Programming by multiple programmers	It is assumed that the Simulator is used on one computer by a single programmer. (It is not possible for more than one programmer to connect to the same Simulator at the same time.)
	Clock information	The time that is read from the computer when the Simulator is started is incremented each time the primary periodic task is executed to generate a virtual clock.
	SD Memory Cards	You cannot use Memory Cards with the Simulator.
	Backing up variables and memory	You cannot back up variables and memory with the Simulator.
Peripheral devices	You cannot connect peripheral devices when connected to the Simulator.	

A-4-2 Task Execution

This section describes the differences in the control methods that are used for task execution between the physical Controller and the Simulator.

NX701 Controller

● Physical Controller

An NX701 Controller gives the highest priority to execution of the primary periodic task. Tasks other than the primary periodic task are executed preferentially in order of the execution priority.

The priority-5 periodic task is executed in parallel with the primary periodic task. The priority-16 periodic task is executed after execution of the primary periodic task is completed.

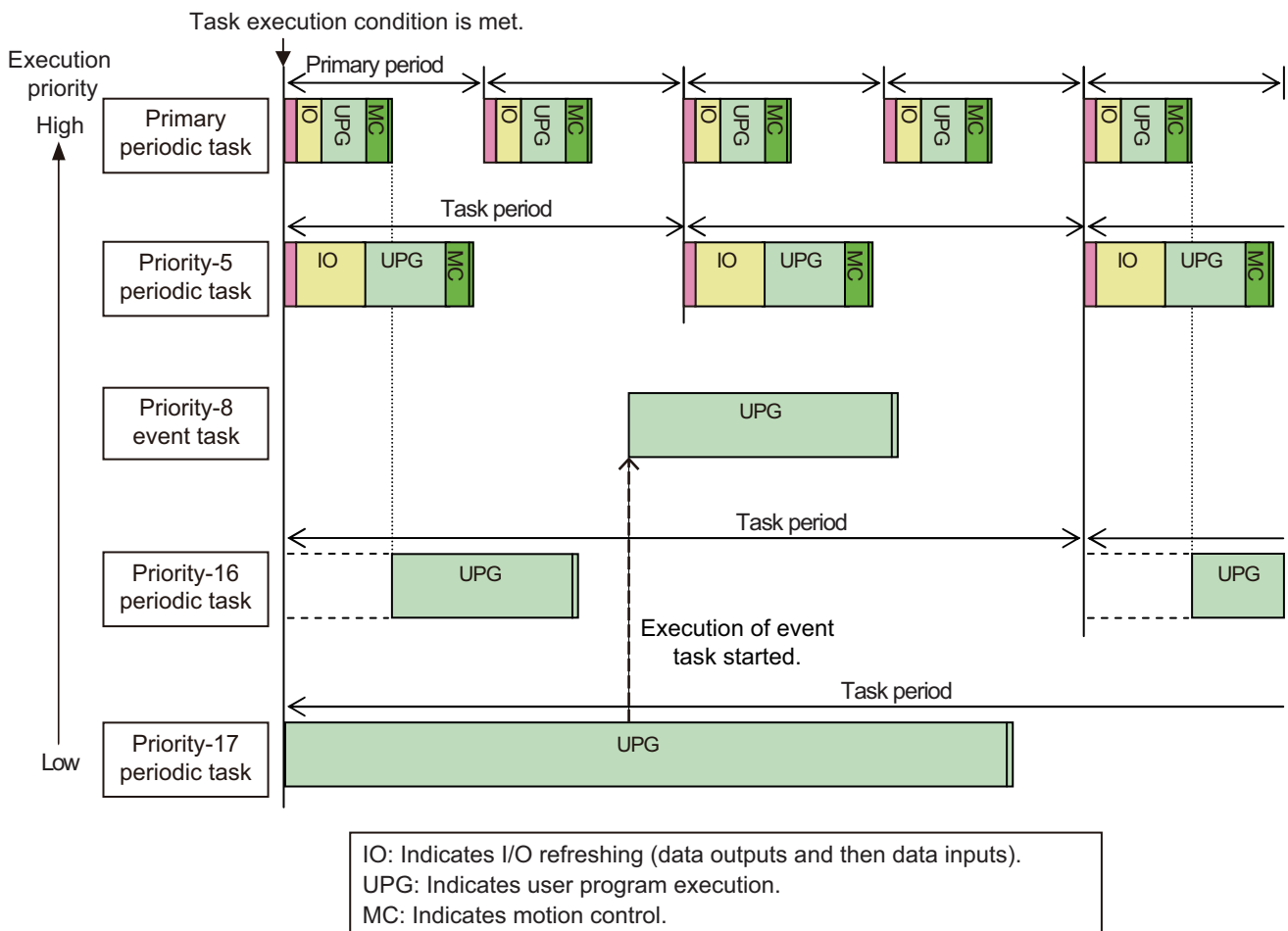

● Simulator

The NX701 Controller Simulator executes the primary periodic task according to the scheduling period determined by the scheduler in the Simulator.

Periodic tasks other than the primary periodic task are executed in order of the execution priority. The priority-5 periodic task is not executed in parallel with the primary periodic task. This differs from the physical Controller.

The periods of periodic tasks other than the primary periodic task are integral multiples of the scheduling period of the Simulator.

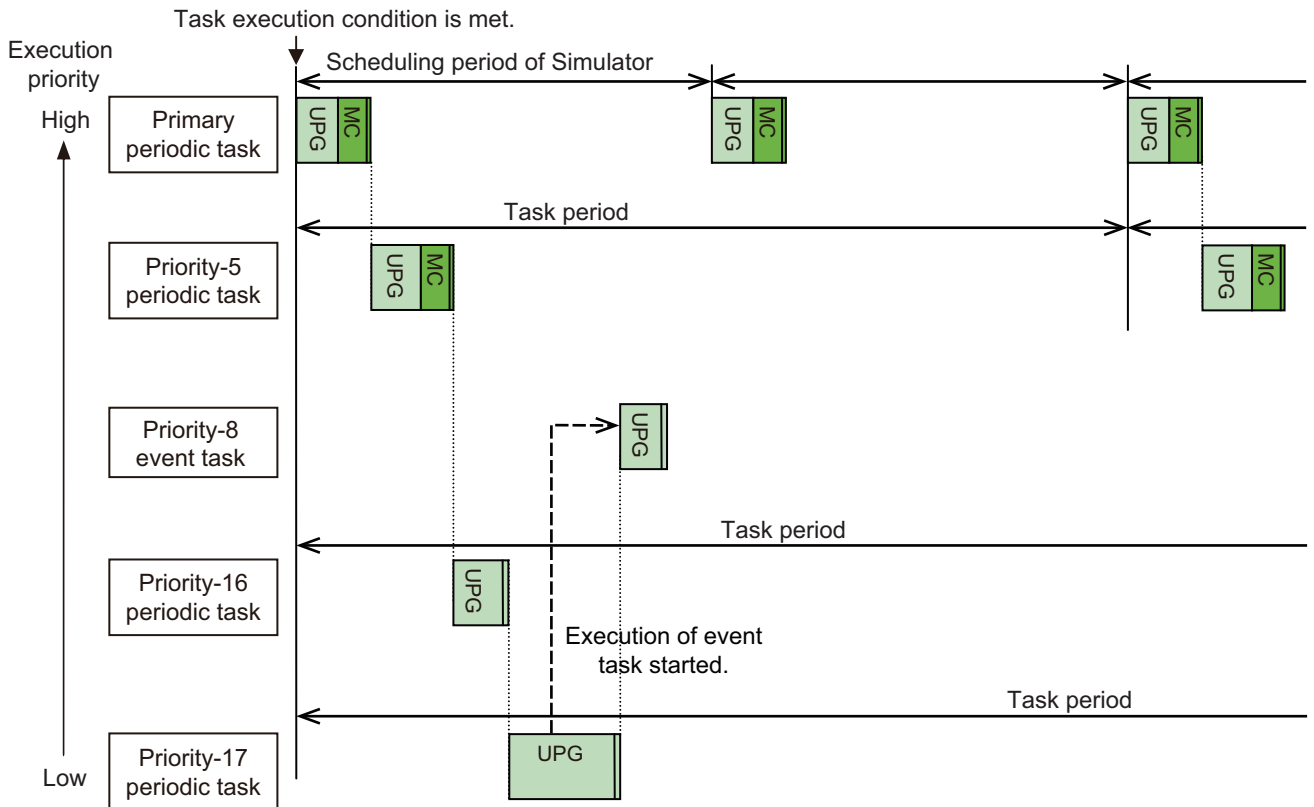

NJ/NY-series Controllers and NX502, NX102, or NX1P2 Controllers

● Physical Controller

For the NJ/NY-series Controllers and NX502, NX102, or NX1P2 Controllers, the tasks are activated every primary period. The execution of a periodic task with a lower priority is interrupted to execute a task with a higher priority (such as the primary periodic task).

An example for an NJ-series Controller is given below.

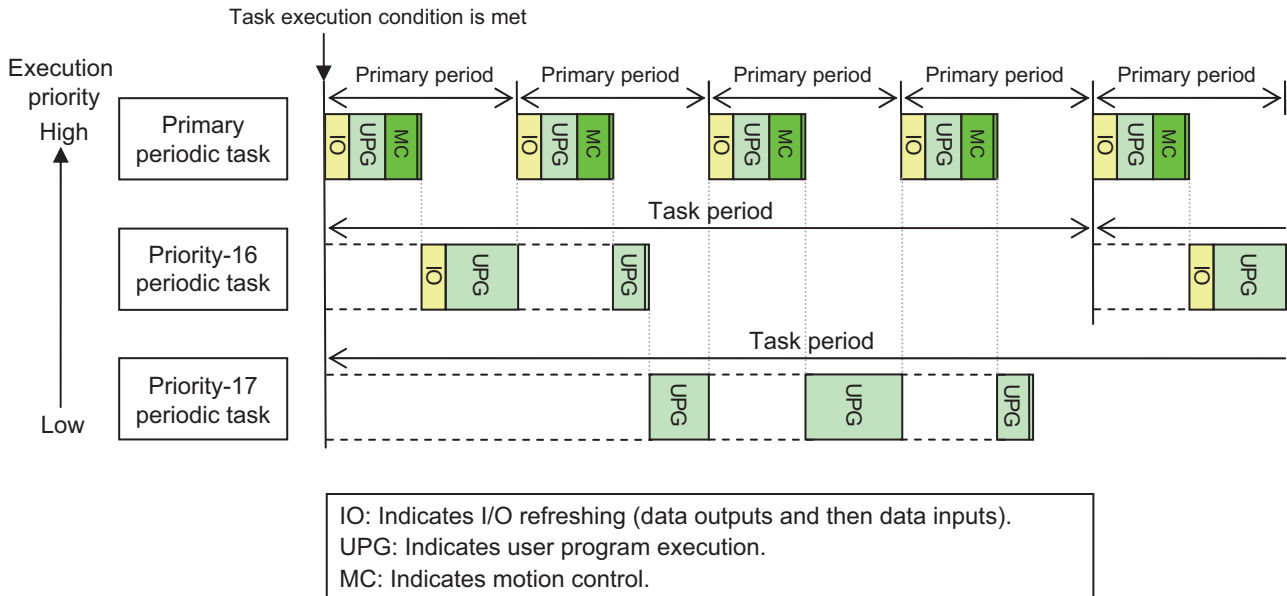

● Simulator

For the NJ/NY-series Controller and NX502, NX102, or NX1P2 Controller Simulator, tasks are executed according to the scheduling policies of the Simulator. Execution of the user program cannot be interrupted like it is in the physical Controller.

An example for an NJ-series Controller is given below.

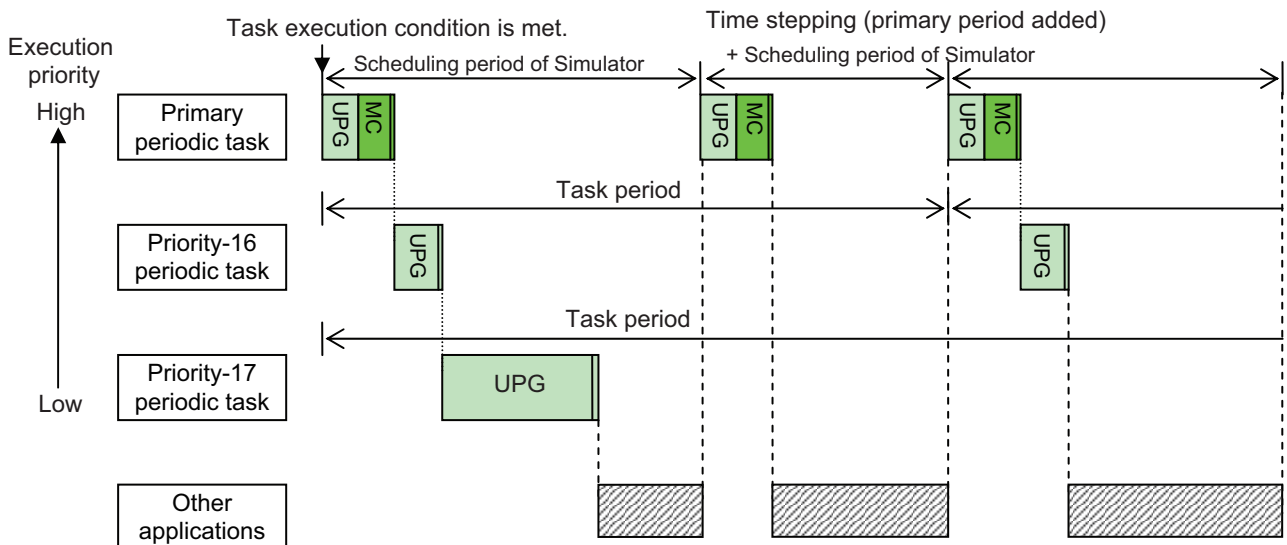

Differences in Task Execution

The differences in the control methods may cause the following differences in operation.

1. Differences in the Timing of Data Exchanges

The end timing of the periodic tasks and the execution order of the tasks are not reproduced precisely. Therefore, the data exchanges between tasks and the timing of obtaining data trace data may be different from the Controller.

2. Differences in Timing of Updating the Time

The clock time in the Simulator is updated by adding the time of the primary period when the execution of all tasks in that period is completed. If you access the clock time from a program, the operation may be different.

Timer instructions are also evaluated at the same time, so the timers may time out at different times.

3. Differences in Operation When Task Execution Times Out

If a simulation is executed in Execution Time Estimation Mode and the execution time is used to execute a long task, the other tasks are not executed until the execution of the long task is completed. Also, when task processing is completed, a *Task Execution Timeout* minor fault will occur. On the Controller, a major fault occurs after a timeout, and operation stops.

A-4-3 Task Execution Times

The Simulator estimates*1 and displays the execution times on the Controller. It displays the results of desktop calculations as the results of the simulation. (Refer to the *NJ/NX-series CPU Unit Software User's Manual (Cat. No. W501)*.)

*1. This estimation is not possible on an NY-series Controller.

- I/O Refresh Processing Time

For the NJ/NX-series Controller, the I/O refresh processing time is calculated based on the *common processing time* and *I/O refresh processing time* that are described in *A-2 Calculating Guidelines for the Real Processing Times of Tasks for the NX-series System* or *A-3 Calculating Guidelines for the Real Processing Times of Tasks for the NJ-series System* in the *NJ/NX-series CPU Unit Software User's Manual (Cat. No. W501)*.

Parameters for each version are given in the above manual.

- Processing Times for the User Program (UPG) and Motion Programs (MCE)

These processing times are estimated with the "calibrated execution time estimation" method (Japanese patent number 4748286).

It is assumed that the estimated value of a task execution time will follow a normal distribution, and estimates are made at the 95% confidence level.



Additional Information

More processing time may be required depending on other applications running on the computer. Do not run any unnecessary applications while the Simulator is running.

A-4-4 Floating-point Data Expressions

Expressions for Infinity and Nonnumeric Data in Real Number-to-Text String Conversion Instructions

The output results for instructions that convert real data to text strings may be different between the Controller and Simulator.

	Expression on the Controller	Expression on the Simulator
Positive infinity	inf	1.#INF00e+000 1.#INF0000000000e+000
Negative infinity	-inf	-1.#INF00e+000 -1.#INF0000000000e+000
Positive nonnumeric data	nan	1.#QNAN0e+000 1.#QNAN0000000000e+000
Negative nonnumeric data	-nan	-1.#IND00e+000 -1.#IND0000000000e+000

Note The number of "zeros" after INF, QNAN, IND will vary.

Exponents

Either two or three digits are given for exponents on the physical Controller. However, you must always give three digits for exponents on the Simulator. When you compare text strings, make sure that the comparison data has the same number of digits.

A-5 Online Help

Online Help

You can access online help from a Sysmac Studio menu to see instruction descriptions or to check shortcut keys. There are four types of help.

- Sysmac Studio help: *Contents*
- Instruction Reference
- Keyboard Mapping Reference
- System-defined Variable Reference

A-5-1 Sysmac Studio Help Contents

Sysmac Studio Help Contents

This help feature provides operating procedures for the Sysmac Studio.

A-5-2 Instruction Reference

Instruction Reference

The Instructions Reference describes the basic instructions and motion control instructions that you can use with an NJ/NX/NY-series Controller. For each instruction, the same description as the one in the following manuals is given.

NJ/NX-series Instructions Reference Manual (Cat. No. W502)

NJ/NX-series Motion Control Instructions Reference Manual (Cat. No. W508)

NY-series Instructions Reference Manual (Cat. No. W560)

NY-series Motion Control Instructions Reference Manual (Cat. No. W561)

● Displaying the Instructions Reference

There are two ways to display the Instructions Reference.

Method (1) From the main menus

Method (2) From the Ladder Editor, ST Editor, or Instruction Navigator

Method (1) From the main menus

Select **Instruction Reference** from the **Help** Menu.

The *Sysmac Studio Instruction Reference Help* is displayed.

Method (2) Displaying the Instructions Reference from the Ladder Editor or ST Editor

In the Ladder Editor or ST Editor, select an instruction that was previously entered or select an instruction in the Instruction Navigator in the Toolbox, and then press the **F1** Key.

The *Sysmac Studio Instruction Reference Help* is displayed for the selected instruction.

A-5-3 Keyboard Mapping Reference

Keyboard Mapping Reference

You can display a list of convenient shortcut keys that you can use on the Sysmac Studio.

- **Displaying the Keyboard Mapping Reference**

Select **Keyboard Mapping Reference** from the **Help** Menu.

The Keyboard Mapping Reference is displayed.

Refer to *A-6 Shortcut Keys* on page A-25 for details.

A-5-4 System Defined Variable Reference

System Defined Variable Reference

You can display a list of descriptions of the system-defined variables that you can use on the Sysmac Studio.

- **Procedure to Display the System Defined Variable Reference**

Select **System Defined Variable Reference** from the **Help** Menu.

Tables of the system-defined variables are displayed.

A-6 Shortcut Keys

The following tables list the shortcut keys that you can use in the Main Window of the Sysmac Studio. You can change the keyboard mapping of some shortcut keys.

A-6-1 Basic Operations		
Operation	Default key/shortcut key setting	Menu command
Displaying help information	F1	Help – Help Contents
Inserting	Insert	None
Deleting	Delete	Edit – Delete
Moving the cursor up one cell	↑	None
Moving the cursor down one cell	↓	None
Moving the cursor right one cell	→	None
Moving the cursor left one cell	←	None
Moving the cursor to the beginning of the row	Home	None
Moving the cursor to the end of the row	End	None
Placing the cursor in Edit Mode	F2	None
Confirming Edit Mode	Enter	None
Moving the cursor to and from the menus	Alt	None
Moving the cursor to the next category	Tab	None
Moving the cursor to the previous category	Shift + Tab	None
Moving the cursor to the next lower level at an expanded item	→	None
Expanding the lower level at a collapsed item	→	None
Collapsing the lower level at an expanded item	←	None
Moving the cursor to the next higher level at a collapsed item	←	None
Displaying/hiding the Output Tab Page	Alt + 3	View – Output Tab Page
Displaying the Watch Tab Page	Alt + 4	View – Watch Tab Page
Displaying/hiding the Cross Reference Tab Page	Alt + 5	View – Cross Reference Tab Page
Displaying/hiding the Build Tab Page	Alt + 6	View – Build Tab Page
Displaying/hiding the Search and Replace Results Tab Page	Alt + 7	View – Search and Replace Results Tab Page
Opening the Simulation Pane	Alt + 8	View – Simulation Pane
Displaying the Differential Monitor Tab Page	Alt + 9	View – Differential Monitor
Displaying the Smart Project Search Dialog Box	Ctrl + Shift + F	View – Smart Project Search
Displaying a thumbnail index of recently closed windows	Ctrl + Shift + H	View – Recently Closed Windows
Jumping to the Multiview Explorer	Shift + Alt + L	Edit – Jump to Multiview Explorer
Enlarging the display	Alt + →	View – Zoom – Zoom In
Reducing the display	Alt + ←	View – Zoom – Zoom Out

Operation	Default key/shortcut key setting	Menu command
Zooming the display to fit the window width	Alt + ↑	View – Zoom – Zoom to Fit
Restoring the default zoom setting	Alt + ↓	View – Zoom – Zoom Reset
Moving to the next page	PageDown	None
Moving to previous page	PageUp	None
Selecting a menu command	Alt + First underlined letter of the command	None
Saving a project	Ctrl + S	File – Save
Printing	Ctrl + P	File – Print
Undoing	Ctrl + Z	Edit – Undo
Redoing	Ctrl + Y	Edit – Redo
Cutting	Ctrl + X	Edit – Cut
Copying	Ctrl + C	Edit – Copy
Pasting	Ctrl + V	Edit – Paste
Selecting everything	Ctrl + A	Edit – Select All
Deleting to the left of the cursor	BackSpace	None
Inverting an input or output to a NOT input or NOT output	/	None
Copying with dependents	Ctrl + Shift + C	None
Deleting a global variable (including external variable)	Ctrl + Shift + Delete	None

A-6-2 Editing Programs

Operation	Default key/shortcut key setting	Menu command
Show/hide Ladder Editor Guide	Ctrl + G	None
Show/hide Ladder Editor Shortcut Key List	H	None
Insert Above	Ctrl + Shift + 1	None
Insert Below	Ctrl + Shift + 2	None
Rung Pattern Copy	Ctrl + Shift + V	None
Inserting a line below the cursor	R	None
Inserting a line above the cursor	Shift + R	None
Entering an N.O. input	C	None
Entering an N.C. input	/	None
Entering an OR with an N.O. input	W	None
Entering an OR with an N.C. input	X	None
Entering an output	O	None
Entering a NOT output	Q	None
Setting upward differentiation for an input	Ctrl + Shift + U or @	None
Setting downward differentiation for an input	Ctrl + Shift + D or %	None
Calling a function block	F	None
Calling a function	I	None
Calling inline ST	S	None
Add Connect Line	T	None
Move Connect Line	M	None

Operation	Default key/shortcut key setting	Menu command
Displaying the contents of a user-defined function or function block	Ctrl + Shift + L	None
Restoring the previous display from a user-defined function or function block	Ctrl + Shift + P	None
Editing variable comments	Ctrl + Enter	None
Jumping from the Ladder or ST Editor to a variable table	Ctrl + Alt + J	None
Adding new members in the Data Type Editor	Ctrl + I	None
Checking all programs	F7	Project – Check All Programs
Checking the selected programs	Shift + F7	Project – Check Selected Programs
Building the project file	F8	Project – Build
Aborting building	Shift + F8	Project – Abort Build
Show Tooltip	Shift + T	None
Enter Element Comment	Alt + Enter	None

A-6-3 Searching and Replacing

Operation	Default key/shortcut key setting	Menu command
Searching and replacing	Ctrl + F	Edit – Search and Replace
Next Variable	N	None
Previous Variable	B	None
Next Input	Ctrl + Shift + I	None
Next Output	Ctrl + Shift + O	None
Retrace Search	Space	None
Specified Rung	G	Edit – Jump
Specified Comment	L	None
Search Next	Alt + N, or F3	None
Search Previous	Shift + F3	None

A-6-4 Online

Operation	Default key/shortcut key setting	Menu command
Going online	Ctrl + W	Controller – Online
Going offline	Ctrl + Shift + W	Controller – Offline
Changing to PROGRAM mode	Ctrl + 1	Controller – Mode – PROGRAM
Changing to RUN mode	Ctrl + 3	Controller – Mode – RUN
Synchronizing	Ctrl + M	Controller – Synchronization
Transferring Controller data from computer to Controller	Ctrl + T	Controller – Transfer – To Controller
Transferring Controller data from Controller to computer	Ctrl + Shift + T	Controller – Transfer – From Controller

Operation	Default key/shortcut key setting	Menu command
Changing the selected program input or output to TRUE	Ctrl + Shift + J	Controller – Set/Reset – Set
Changing the selected program input or output to FALSE	Ctrl + Shift + K	Controller – Set/Reset – Reset
Forcing a selected input or output to TRUE	Ctrl + J	Controller – Forced Refreshing – TRUE
Forcing a selected input or output to FALSE	Ctrl + K	Controller – Forced Refreshing – FALSE
Canceling a selected input or output that was forced to TRUE or FALSE	Ctrl + L	Controller – Forced Refreshing – Cancel
Starting online editing	Ctrl + E	Project – Online Edit – Start
Transferring changes made during online editing	Ctrl + Shift + E	Project – Online Edit – Transfer
Canceling online editing	Ctrl + U	Project – Online Edit – Cancel
Jumping to the current online Edit Pane	Ctrl + Shift + G	Project – Online Edit – Go to Edit Pane

A-6-5 Simulation

Operation	Default key/shortcut key setting	Menu command
Executing a simulation	F5	Simulation – Run
Pausing	Ctrl + Alt + Break	Simulation – Pause
Stopping	Shift + F5	Simulation – Stop
Stepping in	F11	Simulation – Step In
Step execution	F10	Simulation – Step Execution
Stepping out	Shift + F11	Simulation – Step Out
Displaying the Breakpoint Window	Alt + F9	Simulation – Breakpoint Window
Setting/clearing a breakpoint at the cursor position	F9	Simulation – Set/Clear Breakpoints
Clearing all breakpoints	Ctrl + Shift + F9	Simulation – Clear All Breakpoints

A-6-6 SD Memory Card

Operation	Default key/shortcut key setting	Menu command
Going back	Alt + ←	None
Going forward	Alt + →	None
Moving up	Backspace	None
Refreshing	F5	None
Displaying properties	Alt + Enter	None
Formatting	Ctrl + Alt + A	None
Deleting	Delete	None
Copying	Ctrl + C	None
Pasting	Ctrl + V	None
Creating a folder	Ctrl + Alt + F	None
Renaming	F2	None
Ending	Alt + F4	None

A-6-7 Changing Shortcut Keys

You can change the assignment of some shortcut keys for the following functions (commands).

- Main menu commands
- Commands supported in the Edit window (Ladder Editor)

You can assign shortcut keys in the **Shortcut Key Customization** Dialog Box.

Displaying the Shortcut Key Customization Dialog Box

Select **Customize Shortcut Keys** from the **Tools** Menu. The **Shortcut Key Customization** Dialog Box is displayed.

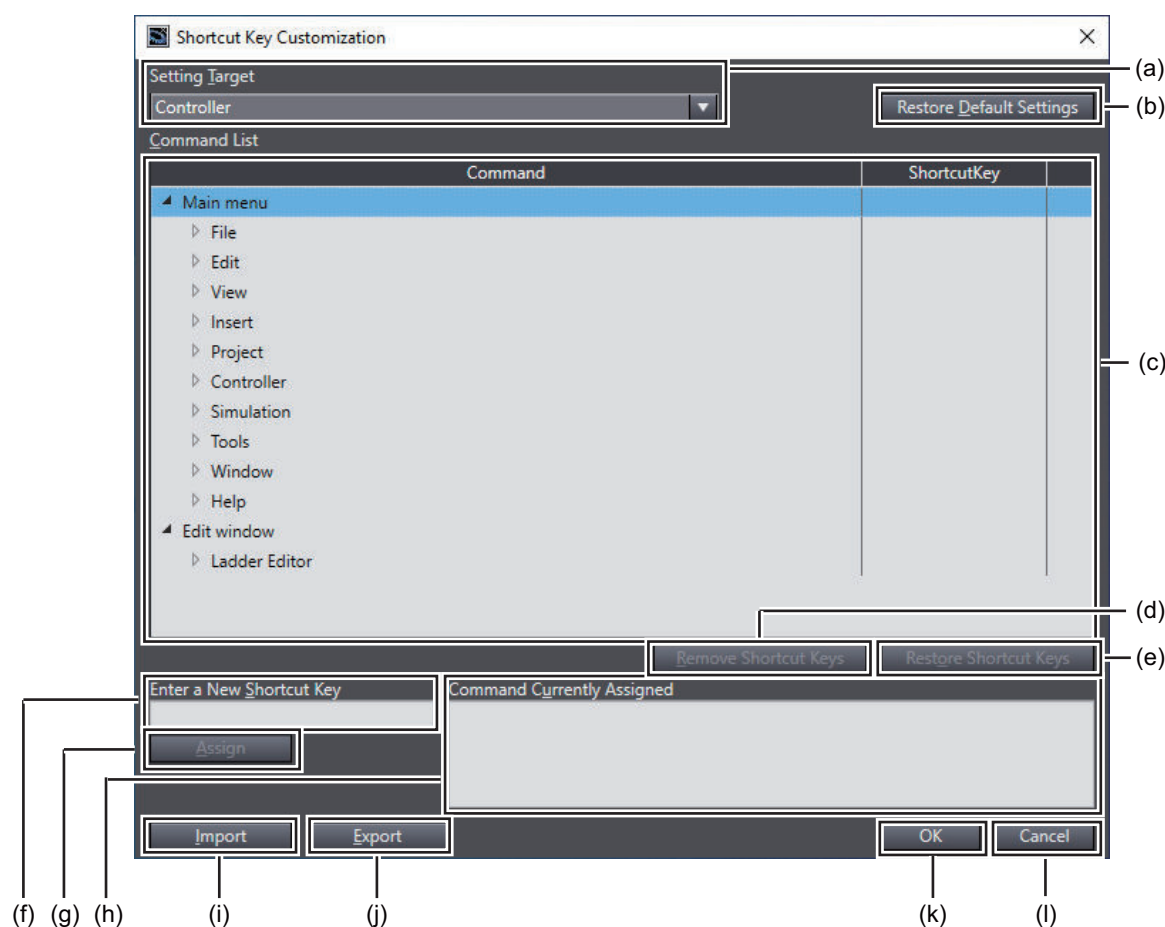

	Displayed item	Description
(a)	Setting Target Dropdown List	Select the target device for which to set shortcut keys from the device categories included in the current project.
(b)	Restore Default Settings Button	Use this button to restore the default settings for the target device selected from the Setting Target Drop-down List.

	Displayed item	Description
(c)	Command List	This shows a list of commands and shortcut keys assigned to the commands for the device selected in the Setting Target Drop-down List. From this list, select the command for which to change the shortcut key. Command column: Main menu commands and commands supported in the Edit window are displayed. ShortcutKey column: Currently assigned shortcut keys are displayed. For commands whose shortcut key settings cannot be changed, shortcut keys are displayed on a gray background. For commands whose shortcut key settings have been changed from the default, commands and shortcut keys are shown in purple.
(d)	Remove Shortcut Keys Button	Use this button to remove the shortcut key that is assigned to the command selected in the Command List.
(e)	Restore Shortcut Keys Button	Use this button to restore the default setting for the command selected in the Command List.
(f)	Enter a New Shortcut Key Box	Enter the keys to assign. When you press a key, a text string that represents the pressed key is entered in this box. To clear the entry, press the Delete or Back-Space Key. Example: When you press the Ctrl Key, <i>Ctrl+</i> is displayed.
(g)	Assign Button	Use this button to assign the shortcut key that is entered in the Enter a New Shortcut Key Box to the command selected in the Command List.
(h)	Command Currently Assigned display area	This shows a list of commands to which you assigned shortcut keys, by entering in a text string the Enter a New Shortcut Key Box. Here, you can check for commands with duplicate shortcut key assignment. Double-clicking a command in the display area causes the corresponding command to be selected in the Command List .
(i)	Import Button	Use this button to import shortcut key assignment settings from a file.
(j)	Export Button	Use this button to save shortcut key assignment settings to a file.
(k)	OK Button	Use this button to save the current changes to the shortcut key settings and close the dialog box.
(l)	Cancel Button	Use this button to discard the current changes to the shortcut key settings and close the dialog box.

Assigning Shortcut Keys

Use the following procedure to assign shortcut keys.

Here, you assign the shortcut key *Ctrl + W* to the *Window - Close* command for the Controller, as an example.

- 1 In the **Setting Target** Drop-down List of the **Shortcut Key Customization** Dialog Box, select the device for which to set the shortcut key. In this example, select **Controller**.
The current shortcut key settings are displayed in the Command List.

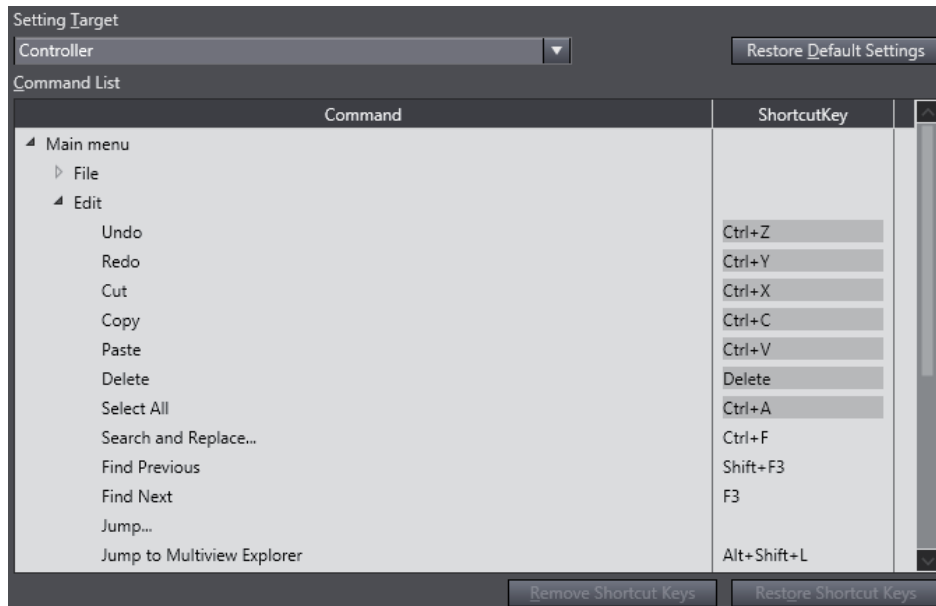

- 2 Select the command to which to assign the shortcut key and click the **Enter a New Shortcut Key** Box. In this example, select **Close** under **Main menu - Window**.

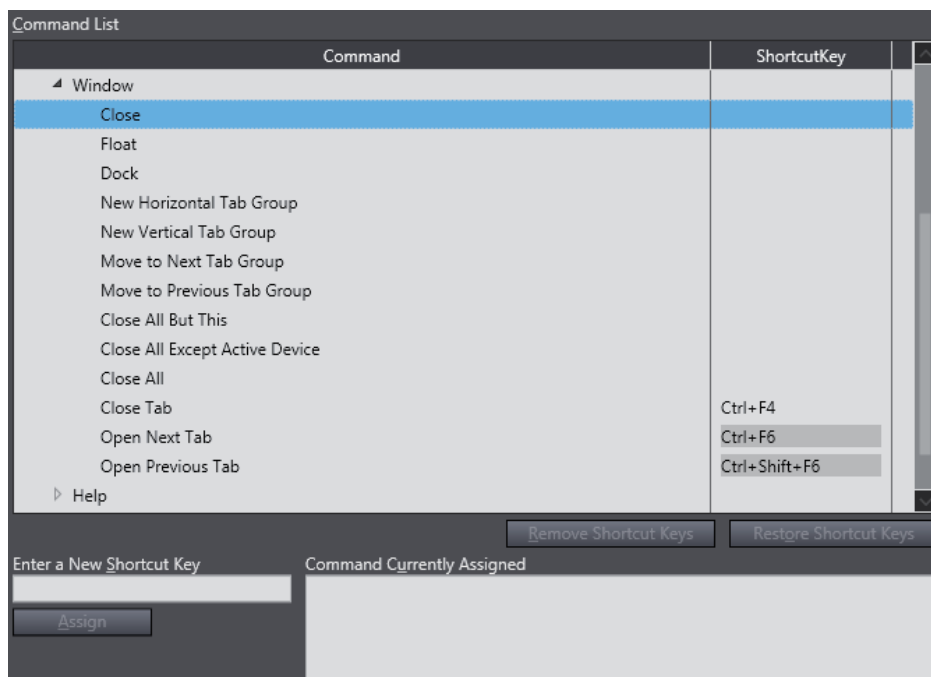

- 3 Press the keys to assign as the shortcut key. In this example, press the Ctrl Key and then press the W Key.
Ctrl + W is now displayed in the **Enter a New Shortcut Key** Box.

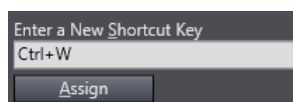

If the shortcut key that you enter in the **Enter a New Shortcut Key** Box has already been assigned to another command, the command will be displayed in the **Command Currently Assigned** display area.

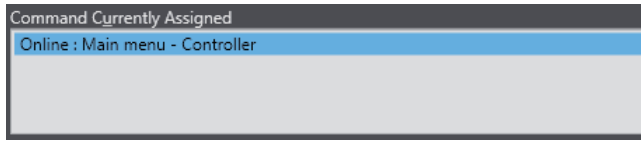

4 Click the **Assign** Button.

If the shortcut key has not been assigned to any command, the shortcut key assignment for the command is changed and the change is reflected on the Command List.

If the shortcut key has already been assigned to another command, a confirmation dialog box is displayed, which asks whether to cancel the current assignment and assign the shortcut key to the new command.

In this example, a confirmation dialog box is displayed because the shortcut key *Ctrl+W* has been assigned to **Online: Main menu - Controller**.

Click the **OK** Button to remove the current assignment and assign the shortcut key to the new command.

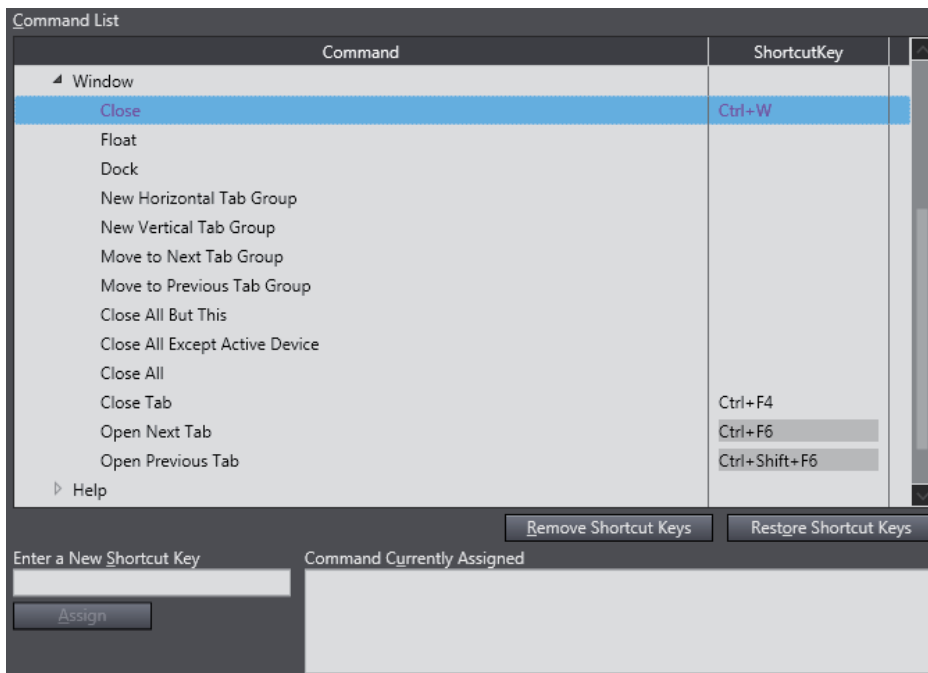



Additional Information

- More than one shortcut key can be assigned to one command.
- Different commands in main menus or in the Edit window cannot have the same shortcut key assigned at the same time. However, commands in main menus and commands in the Edit window can have the same shortcut key assigned.
- Changing the default shortcut key is not possible for some commands. Refer to *Commands Whose Shortcut Key Assignment Cannot Be Changed* on page A-37 for details.
- Some shortcut keys can only be assigned to specific commands. You cannot assign them to other commands. Refer to *Reserved Shortcut Keys* on page A-35 for details.
- To restore the default setting after you change the assignment of a shortcut key, select the command and click the **Restore Shortcut Keys** Button.
- To restore all of the default shortcut key settings for the target device selected from the **Setting Target** Drop-down List, click the **Restore Default Settings** Button.
- The shortcut key assignment settings are stored for each user who logs onto the computer.

Available Shortcut Keys

This section shows a list of keys that can be used as shortcut keys, shortcut keys that can be assigned to main menu commands, and shortcut keys that can be assigned to Ladder Editor commands. It also shows a list of reserved shortcut keys which you cannot assign as shortcut keys.

● Keys That Can Be Used as Shortcut Keys

The table below shows a list of keys that can be used as shortcut keys. You can use a combination of modifier keys and other keys to compose a shortcut key.

Classification		Available keys	Display in Enter a New Shortcut Key Box
Character keys	Alphabetic letters	A to Z	A to Z (Uppercase)
	Numbers	0 to 9	0 to 9
	Space	Space	Space
	Keyboard-layout dependent characters	Depending on keyboard layout of the computer Example of available keyboard-layout dependent characters <ul style="list-style-type: none"> • Japanese keyboard layout: <code>\ - [] , . / ; : ^ @</code> • English keyboard layout: <code>\ - [] , . / ; = ' `</code> • Italian keyboard layout: <code>\ ' ì è + ò à ù , . -</code> 	As entered by key
Numeric keys	Numbers	0 to 9	0 to 9
	Operators	/ * - +	/ * - +
	Decimal point	.	.
	Enter	Enter	Enter

Classification	Available keys	Display in Enter a New Shortcut Key Box
Navigation keys	→	Right
	←	Left
	↑	Up
	↓	Down
	Page Up	PageUp
	Page Down	PageDown
	Home	Home
	End	End
	Tab	Tab
Function keys	F1 to F24	F1 to F24
Enter key	Enter	Enter
Pause/Break key	Pause/Break	Break
Modifier keys	Ctrl	Ctrl
	Alt	Alt
	Shift	Shift

● **Shortcut Keys That Can Be Assigned to Main Menu Commands**

Among the shortcut keys listed in the *Keys That Can Be Used as Shortcut Keys* on page A-33, you can use the following single keys and combinations keys excluding the reserved shortcut keys (see *Reserved Shortcut Keys* on page A-35).

Classification of keys	Shortcut key that can be assigned	
Single keys	Function keys	
Combination keys	Combination with only Shift Key	Function keys
	Combination with Ctrl and Alt Keys	Non-modifier keys that can be used

● **Combination of Shortcut Keys That Can Be Used in the Ladder Editor**

Among the shortcut keys listed in the *Keys That Can Be Used as Shortcut Keys* on page A-33, you can use the following single keys and combinations keys excluding the reserved shortcut keys (see *Reserved Shortcut Keys* on page A-35).

Classification of keys	Shortcut key that can be assigned	
Single keys	Character keys	Alphabetic letters
		Space
		Keyboard-layout dependent characters
	Numeric keys	Operators
		Decimal point
		Enter
	Function keys	
	Enter key	

Classification of keys	Shortcut key that can be assigned		
Combination keys	Combination with only Shift Key	Character keys	Alphabetic letters
			Space
			Keyboard-layout dependent characters
		Numeric keys	Operators
			Decimal point
	Enter		
Function keys			
Enter key			
	Combination with Ctrl and Alt Keys	Non-modifier keys that can be used	

● **Reserved Shortcut Keys**

The following shortcut keys are reserved for use by the Sysmac Studio. You cannot assign them to other commands.

Shortcut key	Command
F1	Displaying help information
F2	Entering Edit Mode
Ctrl + Tab	Switching windows
Ctrl + Shift + Tab	
Alt + F7	
Alt + Shift + F7	
Ctrl + Home	Moving to the beginning
Ctrl + End	Moving to the end
Shift + Right	Selecting an area
Shift + Left	
Shift + Up	
Shift + Down	
Shift + Home	
Shift + End	
Shift + Page Up	
Shift + Page Down	
Ctrl + Shift + Right	
Ctrl + Shift + Left	
Ctrl + Shift + Up	
Ctrl + Shift + Down	
Ctrl + Shift + Home	
Ctrl + Shift + End	

Removing Shortcut Keys

Use the following procedure to remove the shortcut keys that are assigned to a command.

- 1 Select the command for which to remove the shortcut key and click the **Remove Shortcut Keys** Button.
The shortcut key assigned to the command is removed.
If the command has more than one shortcut key assigned, the **Remove Shortcut Keys** Dialog Box is displayed.

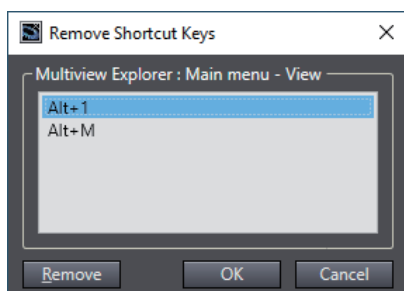

- 2 Select the shortcut key to remove from the shortcut key list, click the **Remove** Button, and then click the **OK** button.
The selected shortcut key is removed from the Command List.

Exporting/Importing Shortcut Keys

You can export/import shortcut key assignment settings after a change to/from an external file.

● Export

The export procedure is described below.

- 1 In the **Shortcut Key Customization** Dialog Box, click the **Export** Button.
The dialog box to specify the export destination is displayed.
- 2 Select the export destination folder and click the **Save** Button.
The current shortcut key assignment settings are saved in the file.

● Import

The import procedure is described below.

- 1 In the **Shortcut Key Customization** Dialog Box, click the **Import** Button.
The dialog box to select the file to import is displayed.
- 2 Select the file from which to import shortcut key settings, and then click the **Open** Button.
The shortcut key settings are imported.

Commands Whose Shortcut Key Assignment Cannot Be Changed

For the following commands, you cannot change shortcut key assignment.

	Menu	Shortcut key
Edit	Undo	Ctrl + Z
	Redo	Ctrl + Y
	Cut	Ctrl + X
	Copy	Ctrl + C
	Paste	Ctrl + V
	Delete	Delete
	Select All	Ctrl + A
View	Zoom In	Alt + Right
	Zoom Out	Alt + Left
	Zoom to Fit	Alt + Up
	Zoom Reset	Alt + Down
Window	Open Next Tab	Ctrl + F6
	Open Previous Tab	Ctrl + Shift + F6

If **Controller** is selected from the Setting Target Drop-down List, you cannot change the following shortcut key assignment as well.

	Menu	Shortcut key	
Insert	Circuit Parts	Line	---
		N.O. Input	---
		N.C. Input	---
		OR with N.O. Input	---
		OR with N.C. Input	---
		Output	---
		NOT Output	---
		Function	---
		Function Block	---

	Ladder Editor	Shortcut key	
Edit/Insert	Start Edit	Enter F2	
	To Upper Layer	Ctrl + Shift + P	
	To Lower Layer	Ctrl + Shift + L	
	Edit Data Type	---	
	Go To Variable Table	Ctrl + Alt + J	
	Bookmarks	Toggle Bookmark	---
		Next Bookmark	---
		Previous Bookmark	---
		Clear All Bookmarks	---
	Fixed Target Cross Ref.	---	
	Edit Connect Line	Move Line Connection Point Above	Ctrl + UP
		Move Line Connection Point Below	Ctrl + Down
		Move Line Connection Right	Ctrl + Right
		Move Line Connection Left	Ctrl + Left

A-7 Simulation Instructions

To simulate motion control instructions, you must create virtual external signals, such as the home proximity input signal and limit input signals.

Use the simulation instructions to create virtual external signals.

- Simulate Positive Limit Input Signal Instruction
- Simulate Negative Limit Input Signal Instruction
- Simulate Home Proximity Signal Instruction
- Simulate Immediate Stop Input Signal Instruction
- Simulate External Latch Input Signal Instruction
- Simulate Drive Alarm Instruction
- Simulate Drive Warning Instruction
- Encoder Velocity Input Instruction
- Write Actual Position Instruction
- Write Actual Velocity Instruction
- Write Actual Torque Instruction



Precautions for Correct Use

You cannot use simulation instructions inside event tasks.

A-7-1 Simulate Positive Limit Input Signal Instruction

This instruction creates a virtual positive limit input signal.

This instruction can be used only when a Servo axis is set.

Instruction	Name	FB/ FUN	Graphic expression	ST expression
SIM_SigPosLmt	Simulate Positive Limit Input Signal	FB		<pre>SIM_SigPosLmt_instance (Axis :=Parameter, Enable :=Parameter, Status =>Parameter, Busy =>Parameter, Error =>Parameter, ErrorID =>Parameter);</pre>

Variables

● Input Variables

Name	Meaning	Data type	Valid range	Default	Description
Enable	Enable	BOOL	TRUE or FALSE	FALSE	The positive limit input signal turns ON when Enable changes to TRUE.

● Output Variables

Name	Meaning	Data type	Valid range	Description
Status	Input signal ON	BOOL	TRUE or FALSE	TRUE when the input signal is ON.
Busy	Executing	BOOL	TRUE or FALSE	TRUE when the instruction is acknowledged.
Error	Error	BOOL	TRUE or FALSE	TRUE while there is an error.
ErrorID	Error code	WORD	---	Contains the error code when an error occurs. A value of 16#0000 indicates normal execution.

● In-Out Variables

Name	Meaning	Data type	Valid range	Description
Axis	Axis	_sAXIS_REF	---	Specifies the axis.*1

*1. Specify an Axis Variable that was created in the Axis Basic Settings of the Sysmac Studio (The default axis variable names are *MC_Axis****.) or a user-defined variable that specifies the address of an Axis Variable.

Function

- When Enable changes to TRUE, a virtual positive limit input signal is created for the axis specified by Axis.
- When Enable changes to FALSE, the positive limit input signal turns OFF for the axis specified by Axis.



Precautions for Correct Use

This instruction must be used only for simulation. Use it only in debug programs. If you use it in a normal program, it is not executed on the physical CPU Unit, but it creates a virtual input signal. Debug programs cannot be executed on the physical CPU Unit.

Errors

An error occurs if there is no slave for the axis specified by Axis. The error code (**0406 hex**) is output to ErrorID.

Refer to *A-7-12 Detailed Information on Error Codes* on page A-56 later in this manual for information on error codes.

A-7-2 Simulate Negative Limit Input Signal Instruction

This instruction creates a virtual negative limit input signal.

This instruction can be used only when a Servo axis is set.

Instruction	Name	FB/ FUN	Graphic expression	ST expression
SIM_SigNegLmt	Negative Limit Input Signal	FB		<pre>SIM_SigNegLmt_instance (Axis :=Parameter, Enable :=Parameter, Status =>Parameter, Busy =>Parameter, Error =>Parameter, ErrorID =>Parameter);</pre>

Variables

● Input Variables

Name	Meaning	Data type	Valid range	Default	Description
Enable	Enable	BOOL	TRUE or FALSE	FALSE	The negative limit input signal turns ON when Enable changes to TRUE.

● Output Variables

Name	Meaning	Data type	Valid range	Description
Status	Input signal ON	BOOL	TRUE or FALSE	TRUE when the input signal is ON.
Busy	Executing	BOOL	TRUE or FALSE	TRUE when the instruction is acknowledged.
Error	Error	BOOL	TRUE or FALSE	TRUE while there is an error.
ErrorID	Error code	WORD	---	Contains the error code when an error occurs. A value of 16#0000 indicates normal execution.

● In-Out Variables

Name	Meaning	Data type	Valid range	Description
Axis	Axis	_sAXIS_REF	---	Specifies the axis.*1

*1. Specify an Axis Variable that was created in the Axis Basic Settings of the Sysmac Studio (The default axis variable names are *MC_Axis****.) or a user-defined variable that specifies the address of an Axis Variable.

Function

- When Enable changes to TRUE, a virtual negative limit input signal is created for the axis specified by Axis.
- When Enable changes to FALSE, the negative limit input signal turns OFF for the axis specified by Axis.



Precautions for Correct Use

This instruction must be used only for simulation. Use it only in debug programs. If you use it in a normal program, it is not executed on the physical CPU Unit, but it creates a virtual input signal. Debug programs cannot be executed on the physical CPU Unit.

Errors

An error occurs if there is no slave for the axis specified by Axis. The error code (**0406 hex**) is output to ErrorID.

Refer to *A-7-12 Detailed Information on Error Codes* on page A-56 later in this manual for information on error codes.

A-7-3 Simulate Home Proximity Signal Instruction

This instruction creates a virtual home proximity signal.

This instruction can be used only when a Servo axis is set.

Instruction	Name	FB/ FUN	Graphic expression	ST expression
SIM_SigOrgProx	Simulate Home Proximity Signal	FB		<pre>SIM_SigOrgProx_instance (Axis :=Parameter, Enable :=Parameter, Status =>Parameter, Busy =>Parameter, Error =>Parameter, ErrorID =>Parameter);</pre>

Variables

● Input Variables

Name	Meaning	Data type	Valid range	Default	Description
Enable	Enable	BOOL	TRUE or FALSE	FALSE	The home proximity signal turns ON when Enable changes to TRUE.

● Output Variables

Name	Meaning	Data type	Valid range	Description
Status	Input signal ON	BOOL	TRUE or FALSE	TRUE when the input signal is ON.
Busy	Executing	BOOL	TRUE or FALSE	TRUE when the instruction is acknowledged.
Error	Error	BOOL	TRUE or FALSE	TRUE while there is an error.
ErrorID	Error code	WORD	---	Contains the error code when an error occurs. A value of 16#0000 indicates normal execution.

● In-Out Variables

Name	Meaning	Data type	Valid range	Description
Axis	Axis	_sAXIS_REF	---	Specifies the axis.*1

*1. Specify an Axis Variable that was created in the Axis Basic Settings of the Sysmac Studio (The default axis variable names are *MC_Axis****.) or a user-defined variable that specifies the address of an Axis Variable.

Function

- When Enable changes to TRUE, a virtual home proximity signal is created for the axis specified by Axis.
- When Enable changes to FALSE, the home proximity signal turns OFF for the axis specified by Axis.



Precautions for Correct Use

This instruction must be used only for simulation. Use it only in debug programs. If you use it in a normal program, it is not executed on the physical CPU Unit, but it creates a virtual input signal. Debug programs cannot be executed on the physical CPU Unit.

Errors

An error occurs if there is no slave for the axis specified by Axis. The error code (**0406 hex**) is output to ErrorID.

Refer to *A-7-12 Detailed Information on Error Codes* on page A-56 later in this manual for information on error codes.

A-7-4 Simulate Immediate Stop Input Signal Instruction

This instruction creates a virtual immediate stop input signal.

This instruction can be used only when a Servo axis is set.

Instruction	Name	FB/ FUN	Graphic expression	ST expression
SIM_SigEmerg- Stop	Simulate Im- mediate Stop Input Signal	FB		<pre>SIM_SigEmergStop_instance (Axis :=Parameter, Enable :=Parameter, Status =>Parameter, Busy =>Parameter, Error =>Parameter, ErrorID =>Parameter);</pre>

Variables

● Input Variables

Name	Meaning	Data type	Valid range	Default	Description
Enable	Enable	BOOL	TRUE or FALSE	FALSE	The immediate stop input signal turns ON when Enable changes to TRUE.

● Output Variables

Name	Meaning	Data type	Valid range	Description
Status	Input signal ON	BOOL	TRUE or FALSE	TRUE when the input signal is ON.
Busy	Executing	BOOL	TRUE or FALSE	TRUE when the instruction is acknowledged.
Error	Error	BOOL	TRUE or FALSE	TRUE while there is an error.
ErrorID	Error code	WORD	---	Contains the error code when an error occurs. A value of 16#0000 indicates normal execution.

● In-Out Variables

Name	Meaning	Data type	Valid range	Description
Axis	Axis	_sAXIS_REF	---	Specifies the axis.*1

*1. Specify an Axis Variable that was created in the Axis Basic Settings of the Sysmac Studio (The default axis variable names are *MC_Axis****.) or a user-defined variable that specifies the address of an Axis Variable.

Function

- When Enable changes to TRUE, a virtual immediate stop input signal is created for the axis specified by Axis.
- When Enable changes to FALSE, the immediate stop input signal turns OFF for the axis specified by Axis.



Precautions for Correct Use

This instruction must be used only for simulation. Use it only in debug programs. If you use it in a normal program, it is not executed on the physical CPU Unit, but it creates a virtual input signal. Debug programs cannot be executed on the physical CPU Unit.

Errors

An error occurs if there is no slave for the axis specified by Axis. The error code (**0406 hex**) is output to ErrorID.

Refer to *A-7-12 Detailed Information on Error Codes* on page A-56 later in this manual for information on error codes.

A-7-5 Simulate External Latch Input Signal Instruction

This instruction creates a virtual external latch input signal.

Instruction	Name	FB/ FUN	Graphic expression	ST expression
SIM_SigExtLatch	Simulate External Latch Input Signal	FB		<pre>SIM_SigExtLatch_instance (Axis :=Parameter, Enable :=Parameter, LatchID :=Parameter, Status =>Parameter, Busy =>Parameter, Error =>Parameter, ErrorID =>Parameter);</pre>

Variables

● Input Variables

Name	Meaning	Data type	Valid range	Default	Description
Enable	Enable	BOOL	TRUE or FALSE	FALSE	The external latch input signal turns ON when Enable changes to TRUE.
LatchID*1	Latch ID selection	UINT	1, 2	1	Specify which of the two latch functions to use. 1: Latch 1 2: Latch 2

*1. For information on the latch IDs, refer to the *NJ/NX-series CPU Unit Motion Control User's Manual (Cat. No. W507)* or *NY-series Industrial Panel PC / Industrial Box PC Motion Control User's Manual (Cat. No. W559)*.

● Output Variables

Name	Meaning	Data type	Valid range	Description
Status	Input signal ON	BOOL	TRUE or FALSE	TRUE when the input signal is ON.
Busy	Executing	BOOL	TRUE or FALSE	TRUE when the instruction is acknowledged.
Error	Error	BOOL	TRUE or FALSE	TRUE while there is an error.
ErrorID	Error code	WORD	---	Contains the error code when an error occurs. A value of 16#0000 indicates normal execution.

● In-Out Variables

Name	Meaning	Data type	Valid range	Description
Axis	Axis	_sAXIS_REF	---	Specifies the axis.*1

*1. Specify an Axis Variable that was created in the Axis Basic Settings of the Sysmac Studio (The default axis variable names are *MC_Axis****.) or a user-defined variable that specifies the address of an Axis Variable.

Function

- When Enable changes to TRUE, a virtual external latch input signal is created for the axis specified by Axis.
- When Enable changes to FALSE, the virtual external latch input signal turns OFF for the axis specified by Axis.



Precautions for Correct Use

This instruction must be used only for simulation. Use it only in debug programs. If you use it in a normal program, it is not executed on the physical CPU Unit, but it creates a virtual input signal. Debug programs cannot be executed on the physical CPU Unit.

Errors

An error occurs in the following case.

- An error occurs if latch ID selection LatchID is not 1 or 2. The error code (**0400 hex**) is output to ErrorID.
- An error occurs if there is no slave for the axis specified by Axis. The error code (**0406 hex**) is output to ErrorID.

Refer to *A-7-12 Detailed Information on Error Codes* on page A-56 later in this manual for information on error codes.

A-7-6 Simulate Drive Alarm Instruction

This instruction creates a virtual Drive alarm.

This instruction can be used only when a Servo axis is set.

Instruction	Name	FB/ FUN	Graphic expression	ST expression
SIM_SetDrvAlm	Simulate Drive Alarm	FB		<pre>SIM_SetDrvAlm_instance (Axis :=Parameter, Execute :=Parameter, Done =>Parameter, Busy =>Parameter, Failure =>Parameter, Error =>Parameter, ErrorID =>Parameter);</pre>

Variables

● Input Variables

Name	Meaning	Data type	Valid range	Default	Description
Execute	Execute	BOOL	TRUE or FALSE	FALSE	The instruction is executed when Execute changes to TRUE.

● Output Variables

Name	Meaning	Data type	Valid range	Description
Done	Done	BOOL	TRUE or FALSE	TRUE when instruction execution is completed normally.
Busy	Busy	BOOL	TRUE or FALSE	TRUE when the instruction is acknowledged.
Failure	Error end	BOOL	TRUE or FALSE	TRUE when instruction execution is not completed normally.
Error	Error	BOOL	TRUE or FALSE	TRUE while there is an error.
ErrorID	Error code	WORD	---	Contains the error code when an error occurs. A value of 16#0000 indicates normal execution.

● In-Out Variables

Name	Meaning	Data type	Valid range	Description
Axis	Axis	_sAXIS_REF	---	Specifies the axis.*1

*1. Specify an Axis Variable that was created in the Axis Basic Settings of the Sysmac Studio (The default axis variable names are MC_Axis***.) or a user-defined variable that specifies the address of an Axis Variable.

Function

- When Execute changes to TRUE, a virtual Drive alarm is created for the axis specified by Axis.
- Execute the MC_Reset (Reset Axis Error) instruction to reset the Drive alarm.



Precautions for Correct Use

This instruction must be used only for simulation. Use it only in debug programs. If you use it in a normal program, it is not executed on the physical CPU Unit, but it creates a virtual input signal. Debug programs cannot be executed on the physical CPU Unit.

Errors

An error occurs if there is no slave for the axis specified by Axis. The error code (**0406 hex**) is output to ErrorID.

Refer to A-7-12 Detailed Information on Error Codes on page A-56 later in this manual for information on error codes.

A-7-7 Simulate Drive Warning Instruction

This instruction creates a virtual Drive warning.

This instruction can be used only when a Servo axis is set.

Instruction	Name	FB/FUN	Graphic expression	ST expression
SIM_SetDrvWarn	Simulate Drive Warning	FB		<pre>SIM_SetDrvWarn_instance (Axis :=Parameter, Execute :=Parameter, Done =>Parameter, Busy =>Parameter, Failure =>Parameter, Error =>Parameter, ErrorID =>Parameter);</pre>

Variables

● Input Variables

Name	Meaning	Data type	Valid range	Default	Description
Execute	Execute	BOOL	TRUE or FALSE	FALSE	The instruction is executed when Execute changes to TRUE.

● Output Variables

Name	Meaning	Data type	Valid range	Description
Done	Done	BOOL	TRUE or FALSE	TRUE when instruction execution is completed normally.
Busy	Busy	BOOL	TRUE or FALSE	TRUE when the instruction is acknowledged.
Failure	Error end	BOOL	TRUE or FALSE	TRUE when instruction execution is not completed normally.
Error	Error	BOOL	TRUE or FALSE	TRUE while there is an error.
ErrorID	Error code	WORD	---	Contains the error code when an error occurs. A value of 16#0000 indicates normal execution.

● In-Out Variables

Name	Meaning	Data type	Valid range	Description
Axis	Axis	_sAXIS_REF	---	Specifies the axis.*1

*1. Specify an Axis Variable that was created in the Axis Basic Settings of the Sysmac Studio (The default axis variable names are *MC_Axis****.) or a user-defined variable that specifies the address of an Axis Variable.

Function

- When Execute changes to TRUE, a virtual Drive warning is created for the axis specified by Axis.
- A drive warning is automatically reset in the next cycle after the virtual warning.



Precautions for Correct Use

This instruction must be used only for simulation. Use it only in debug programs. If you use it in a normal program, it is not executed on the physical CPU Unit, but it creates a virtual input signal. Debug programs cannot be executed on the physical CPU Unit.

Errors

An error occurs if there is no slave for the axis specified by Axis. The error code (**0406 hex**) is output to ErrorID.

Refer to *A-7-12 Detailed Information on Error Codes* on page A-56 later in this manual for information on error codes.

A-7-8 Encoder Velocity Input Instruction

This instruction writes a virtual velocity for the current velocity of an encoder axis.

This instruction can be used only when an encoder axis is set.

A CPU Unit with unit version 1.02 or later is required to use this instruction.

Instruction	Name	FB/ FUN	Graphic expression	ST expression
SIM_SetVelocity	Encoder Velocity Input	FB		<pre>SIM_SetVelocity_instance(Axis :=parameter, Execute :=parameter, Velocity :=parameter, Done =>parameter, Busy =>parameter, Failure =>parameter, Error =>parameter, ErrorID =>parameter,);</pre>

Variables

● Input Variables

Name	Meaning	Data type	Valid range	Default	Description
Execute	Execute	BOOL	TRUE or FALSE	FALSE	The instruction is executed when Execute changes to TRUE.
Velocity	Current Velocity	LREAL	Negative number, positive number, or 0	0	Specifies the current velocity. (The unit is pulses/s.)

● Output Variables

Name	Meaning	Data type	Valid range	Description
Done	Done	BOOL	TRUE or FALSE	TRUE when instruction execution is completed normally.
Busy	Executing	BOOL	TRUE or FALSE	TRUE when the instruction is acknowledged. FALSE when instruction processing is completed.
Failure	Failure	BOOL	TRUE or FALSE	TRUE when instruction execution is not completed normally. * Always FALSE on Sysmac Studio version 1.03.
Error	Error	BOOL	TRUE or FALSE	TRUE while there is an error.
ErrorID	Error code	WORD	---	Contains the error code when an error occurs. A value of 16#0000 indicates normal execution.

● In-Out Variables

Name	Meaning	Data type	Valid range	Description
Axis	Axis	_sAXIS_REF	---	Specifies the axis.*1

*1. Specify an Axis Variable that was created in the Axis Basic Settings of the Sysmac Studio (The default axis variable names are *MC_Axis****.) or a user-defined variable that specifies the address of an Axis Variable.

Function

When *Execute* changes to TRUE, the current velocity of the axis that is specified by *Axis* is changed to a virtual velocity.



Precautions for Correct Use

This instruction must be used only for simulation. Use it only in debug programs. If you use it in a normal program, it is not executed on the physical CPU Unit, but it virtually changes the current velocity. Debug programs cannot be executed on the physical CPU Unit.

Errors

An error occurs if there is no slave for the axis specified by *Axis*. The error code (**0406 hex**) is output to *ErrorID*.

Refer to *A-7-12 Detailed Information on Error Codes* on page A-56 later in this manual for information on error codes.

A-7-9 Write Actual Position Instruction

This instruction writes the actual position from the drive emulator to the process data object in the axis variable.

A CPU Unit with unit version 1.09 or later is required to use this instruction.

Instruction	Name	FB/ FUN	Graphic expression	ST expression
SIM_SetActPos	Write Actual Position	FB		<pre>SIM_SetActPos_instance(Axis :=Parameter, Enable :=Parameter, SetPos :=Parameter, Status =>Parameter, Busy =>Parameter, Error =>Parameter, ErrorID =>Parameter);</pre>

Variables

● Input Variables

Name	Meaning	Data type	Valid range	Default	Description
Enable	Enable	BOOL	TRUE or FALSE	FALSE	The instruction is executed while Enable is TRUE.
SetPos	Actual position	LREAL	Negative number, positive number, or 0	0	Specifies the absolute value of the actual position. (The unit is command units.) In Rotary Mode, operation is performed with the shortest way specification.

● Output Variables

Name	Meaning	Data type	Valid range	Description
Status	Input signal ON	BOOL	TRUE or FALSE	TRUE when the input signal is ON.
Busy	Executing	BOOL	TRUE or FALSE	TRUE when the instruction is acknowledged.
Error	Error	BOOL	TRUE or FALSE	TRUE while there is an error.
ErrorID	Error code	WORD	---	Contains the error code when an error occurs. A value of 16#0000 indicates normal execution.

● In-Out Variables

Name	Meaning	Data type	Valid range	Description
Axis	Axis	_sAXIS_REF	---	Specifies the axis.*1

*1. Specify an Axis Variable that was created in the Axis Basic Settings of the Sysmac Studio (The default axis variable names are *MC_Axis****.) or a user-defined variable that specifies the address of an Axis Variable.

Function

While Enable is TRUE, the specified actual position is written to the process data object in Axis. The drive emulator does not wrap the actual position while execution of this instruction is in progress. When Enable changes to FALSE, the operating mode from before instruction execution is restored and the actual position is updated.



Precautions for Correct Use

- This instruction must be used only for simulation. Use it only in debug programs. If you use it in a normal program, it is not executed on the physical CPU Unit, but it virtually changes the actual position process data. Debug programs cannot be executed on the physical CPU Unit.
- If you use this instruction, place only one instruction in the user program for each axis. The intended operation may not be achieved if you place more than one instruction in the user program for the same axis.
- Make sure that the value that you write to the process data object does not exceed 32 bits when converted to pulses by the electronic gear. If 32 bits is exceeded, the intended operation may not occur.
- If you use this instruction, assign a different instance for each axis. You cannot use the same instance for more than one axis.
- Do not use this instruction for an encoder axis. The intended operation may not occur.
- This instruction updates the process data object data instead of the Servo Drive. Use it in the task with the shortest control period.
- The following restrictions apply to the use of this instruction.
 - a) You cannot use it for a virtual axis.
 - b) You cannot use it while the Servo is OFF.
 - c) You cannot execute the MC_Home instruction or MC_SetPosition instruction during execution of this instruction.
 - d) Any changes to the axis parameters, such as the gear ratio, that are made with the MC_WriteAxisParameter instruction are ignored by this instruction.

Errors

An error occurs and an error code is output in the following cases.

Error cause	Error code
There is no slave that corresponds to Axis.	0406 hex
The actual position is outside of the allowable input range.	0400 hex
An object that is required for this instruction is not set.	3461 hex

Refer to *A-7-12 Detailed Information on Error Codes* on page A-56 later in this manual for information on error codes.

A-7-10 Write Actual Velocity Instruction

This instruction writes the actual velocity from the drive emulator to the process data object in the axis variable.

A CPU Unit with unit version 1.09 or later is required to use this instruction.

Instruction	Name	FB/ FUN	Graphic expression	ST expression
SIM_SetActVel	Write Actual Velocity	FB		<pre>SIM_SetActVel_instance(Axis :=Parameter, Enable :=Parameter, SetVel :=Parameter, Status =>Parameter, Busy =>Parameter, Error =>Parameter, ErrorID =>Parameter);</pre>

Variables

● Input Variables

Name	Meaning	Data type	Valid range	Default	Description
Enable	Enable	BOOL	TRUE or FALSE	FALSE	The instruction is executed while Enable is TRUE.
SetVel	Actual velocity	LREAL	Negative number, positive number, or 0	0	Specifies the actual velocity. (The unit is command units/s.)

● Output Variables

Name	Meaning	Data type	Valid range	Description
Status	Input signal ON	BOOL	TRUE or FALSE	TRUE when the input signal is ON.
Busy	Executing	BOOL	TRUE or FALSE	TRUE when the instruction is acknowledged.
Error	Error	BOOL	TRUE or FALSE	TRUE while there is an error.

Name	Meaning	Data type	Valid range	Description
ErrorID	Error code	WORD	---	Contains the error code when an error occurs. A value of 16#0000 indicates normal execution.

● **In-Out Variables**

Name	Meaning	Data type	Valid range	Description
Axis	Axis	_sAXIS_REF	---	Specifies the axis.*1

*1. Specify an Axis Variable that was created in the Axis Basic Settings of the Sysmac Studio (The default axis variable names are *MC_Axis****.) or a user-defined variable that specifies the address of an Axis Variable.

Function

While Enable is TRUE, the specified actual velocity is written to the process data object in Axis. When Enable changes to FALSE, the actual velocity is not written.



Precautions for Correct Use

- This instruction must be used only for simulation. Use it only in debug programs. If you use it in a normal program, it is not executed on the physical CPU Unit, but it virtually changes the actual velocity process data. Debug programs cannot be executed on the physical CPU Unit.
- To use this instruction, you must map the process data object. An error will occur if you execute this instruction without mapping the object.
- If you use this instruction, place only one instruction in the user program for each axis. The intended operation may not be achieved if you place more than one instruction in the user program for the same axis.
- Make sure that the value that you write to the process data object does not exceed 32 bits when converted to pulses by the electronic gear. If 32 bits is exceeded, the intended operation may not occur.
- If you use this instruction, assign a different instance for each axis. You cannot use the same instance for more than one axis.
- Do not use this instruction for an encoder axis. The intended operation may not occur.
- This instruction updates the process data object data instead of the Servo Drive. Use it in the task with the shortest control period.
- The following restrictions apply to the use of this instruction.
 - a) You cannot use it for a virtual axis.
 - b) You cannot use it while the Servo is OFF.
 - c) You cannot execute the MC_Home instruction or MC_SetPosition instruction during execution of this instruction.
 - d) Any changes to the axis parameters, such as the gear ratio, that are made with the MC_WriteAxisParameter instruction are ignored by this instruction.

Errors

An error occurs and an error code is output in the following cases.

Error cause	Error code
There is no slave that corresponds to Axis.	0406 hex
The actual velocity is outside of the allowable input range.	0400 hex
An object that is required for this instruction is not set.	3461 hex

Refer to *A-7-12 Detailed Information on Error Codes* on page A-56 later in this manual for information on error codes.

A-7-11 Write Actual Torque Instruction

This instruction writes the actual torque from the drive emulator to the process data object in the axis variable.

A CPU Unit with unit version 1.09 or later is required to use this instruction.

Instruction	Name	FB/ FUN	Graphic expression	ST expression
SIM_SetActTrq	Write Actual Torque	FB		<pre>SIM_SetActTrq_instance(Axis :=Parameter, Enable :=Parameter, SetTrq :=Parameter, Status =>Parameter, Busy =>Parameter, Error =>Parameter, ErrorID =>Parameter);</pre>

Variables

● Input Variables

Name	Meaning	Data type	Valid range	Default	Description
Enable	Enable	BOOL	TRUE or FALSE	FALSE	The instruction is executed while Enable is TRUE.
SetTrq	Actual torque	LREAL	Negative number, positive number, or 0	0	Specifies the actual torque. (The unit is %.) Specifies the target torque to output to the Servo Drive in increments of 0.1%. Specify a percentage of the rated torque, i.e., the rated torque is 100.0%.

● Output Variables

Name	Meaning	Data type	Valid range	Description
Status	Input signal ON	BOOL	TRUE or FALSE	TRUE when the input signal is ON.
Busy	Executing	BOOL	TRUE or FALSE	TRUE when the instruction is acknowledged.
Error	Error	BOOL	TRUE or FALSE	TRUE while there is an error.
ErrorID	Error code	WORD	---	Contains the error code when an error occurs. A value of 16#0000 indicates normal execution.

● In-Out Variables

Name	Meaning	Data type	Valid range	Description
Axis	Axis	_sAXIS_REF	---	Specifies the axis.*1

*1. Specify an Axis Variable that was created in the Axis Basic Settings of the Sysmac Studio (The default axis variable names are *MC_Axis****.) or a user-defined variable that specifies the address of an Axis Variable.

Function

While Enable is TRUE, the specified actual torque is written to the process data object in Axis.

Specify the target torque to output to the Servo Drive in increments of 0.1%.

When Enable changes to FALSE, the actual torque is not written.



Precautions for Correct Use

- This instruction must be used only for simulation. Use it only in debug programs. If you use it in a normal program, it is not executed on the physical CPU Unit, but it virtually changes the actual torque process data. Debug programs cannot be executed on the physical CPU Unit.
- If you use this instruction, place only one instruction in the user program for each axis. The intended operation may not be achieved if you place more than one instruction in the user program for the same axis.
- Make sure that the value that you write to the process data object does not exceed 32 bits when converted to pulses by the electronic gear. If 32 bits is exceeded, the intended operation may not occur.
- If you use this instruction, assign a different instance for each axis. You cannot use the same instance for more than one axis.
- Do not use this instruction for an encoder axis. The intended operation may not occur.
- This instruction updates the process data object data instead of the Servo Drive. Use it in the task with the shortest control period.
- The following restrictions apply to the use of this instruction.
 - a) You cannot use it for a virtual axis.
 - b) You cannot use it while the Servo is OFF.
 - c) You cannot execute the MC_Home instruction or MC_SetPosition instruction during execution of this instruction.
 - d) Any changes to the axis parameters, such as the gear ratio, that are made with the MC_WriteAxisParameter instruction are ignored by this instruction.

Errors

An error occurs and an error code is output in the following cases.

Error cause	Error code
There is no slave that corresponds to Axis.	0406 hex
The actual torque is outside of the allowable input range.	0400 hex
An object that is required for this instruction is not set.	3461 hex

Refer to *A-7-12 Detailed Information on Error Codes* on page A-56 later in this manual for information on error codes.

A-7-12 Detailed Information on Error Codes

Detailed information is available on errors that occur for instructions.

Errors are given as event codes that use the error code as the lower four digits. For descriptions of an error code, refer to the description of the corresponding event code. For example, if the error code for the instruction is 0400 hex, refer to the description for event code 54010400 hex.

Event name	Input Value Out of Range		Event code	54010400 hex		
Meaning	An input parameter for an instruction exceeded the valid range for an input variable. Or, division by an integer of 0 occurred in division or remainder calculations.					
Source	PLC Function Module		Source details	Instruction	Detection timing	At instruction execution
Error attributes	Level	Observation	Recovery	---	Log category	System
Effects	User program	Continues.	Operation	The relevant instruction will end according to specifications.		
System-defined variables	Variable		Data type		Name	
	None		---		---	
Cause and correction	Assumed cause		Correction		Prevention	
	An input parameter for an instruction exceeded the valid range for an input variable. Or, division by an integer of 0 occurred in division or remainder calculations.		Check the valid range for the input variables of the instruction. Make sure the input parameters are within the valid range and that no division by 0 or remainder calculation for 0 is performed.		Set the value of the input parameter to the instruction so that the input range is not exceeded.	
Attached information	Attached Information 1: Error Location Attached Information 2: Error Location Detail, Rung Number. For a program section, the rung number from the start of the section is given. For ST, the line number is given. Attached Information 3: Instruction Name and Instruction Instance Name Where Error Occurred. If there is more than one instruction, all of them are given. If the instruction cannot be identified, nothing is given. Attached Information 4: Expansion Error Code (ErrorIDEx)					
Precautions/Remarks	If a program is changed after an error occurs, the attached information that is displayed may not be correct.					

Event name	Illegal Data Position Specified		Event code	54010406 hex		
Meaning	A memory address or data size that was specified for the instruction is not suitable.					
Source	PLC Function Module		Source details	Instruction	Detection timing	At instruction execution
Error attributes	Level	Observation	Recovery	---	Log category	System
Effects	User program	Continues.	Operation	The relevant instruction will end according to specifications.		
System-defined variables	Variable		Data type		Name	
	None		---		---	

Cause and correction	Assumed cause	Correction	Prevention
	A memory address that was specified for an instruction was outside the valid range. The data size that was specified for an instruction exceeded the valid range. For example, the data type of a variable and the data size may not agree.	Correct the instruction so that the specified data memory addresses and data sizes do not exceed the valid ranges.	Use instructions so that the specified data memory addresses and data sizes do not exceed the valid ranges.
Attached information	Attached Information 1: Error Location Attached Information 2: Error Location Detail, Rung Number. For a program section, the rung number from the start of the section is given. For ST, the line number is given. Attached Information 3: Instruction Name and Instruction Instance Name Where Error Occurred. If there is more than one instruction, all of them are given. If the instruction cannot be identified, nothing is given. Attached Information 4: Expansion Error Code (ErrorIDEx)		
Precautions/Remarks	If a program is changed after an error occurs, the attached information that is displayed may not be correct.		



Event name	Process Data Object Setting Missing		Event code	54013461 hex	
Meaning	The PDO mapping is not correct.				
Source	PLC Function Module		Source details	Instruction	Detection timing At instruction execution
Error attributes	Level	Observation	Recovery	---	Log category System
Effects	User program	Continues.	Operation	The relevant instruction will end according to specifications.	
System-defined variables	Variable		Data type		Name
	_MC_AX[*].MFAultLvl.Active		BOOL		Axis Minor Fault Occurrence
Cause and correction	Assumed cause		Correction		Prevention
	The PDOs that are required for the motion control instruction are not mapped.		Map the PDOs that are required for the instruction. Refer to the <i>Function</i> section of the relevant instruction for the required PDOs.		Map the PDOs that are required for the instructions that are used. Refer to the <i>NJ/NX-series CPU Unit Motion Control User's Manual (Cat. No. W507)</i> or <i>NY-series Industrial Panel PC / Industrial Box PC Motion Control User's Manual (Cat. No. W559)</i> for the PDOs (Servo Drive settings) that you must map for each instruction.
	The relevant instruction was executed for a target device that does not have an object that supports the instruction.		Some devices do not support the relevant instruction. Refer to the manual for the target device, check to see if the relevant instruction is supported, and correct the program so that unsupported instructions are not executed.		Refer to the manual for the target device and write the program so that unsupported instructions are not executed.
Attached information	Attached Information 1: Error Location Attached Information 2: Error Location Detail, Rung Number. For a program section, the rung number from the start of the section is given. For ST, the line number is given. Attached Information 3: Instruction Name and Instruction Instance Name Where Error Occurred. If there is more than one instruction, all of them are given. If the instruction cannot be identified, nothing is given. Attached Information 4: Expansion Error Code (ErrorIDEx)				
Precautions/Remarks	If a program is changed after an error occurs, the attached information that is displayed may not be correct.				

A-8 Directly Connecting to an EtherCAT Slave Terminal

Instead of going online with the NJ/NX/NY-series Controller, you can connect directly to the EtherCAT Coupler Unit with a USB cable. If an OMRON EtherCAT Coupler Unit is connected to an EtherCAT network with a master that is not an OMRON product, you can connect to the Slave Terminal to go online with it and perform operations, such as transferring Unit settings.

The operating procedures are given below. Refer to the *NX-series EtherCAT Coupler Units User's Manual (Cat. No. W519)* for function details.

When you connect the computer to the USB port on the Communications Coupler Unit the first time, install the USB driver. Refer to *A-1 Driver Installation for Direct USB Cable Connection* on page A-3 for installing the USB driver.

A

A-8-1 Procedure for Directly Connecting to an EtherCAT Slave Terminal

Use the following procedure to directly connect to an EtherCAT Slave Terminal with a USB cable.

- 1 Connect the computer to the EtherCAT Coupler Unit with a USB cable.
- 2 Create a project for an NJ/NX/NY-series Controller and create the configuration for an EtherCAT Slave Terminal. Refer to 5-3 **EtherCAT Slave Terminal Configuration and Setup** on page 5-25 for the procedures.
- 3 Right-click the Communications Coupler Unit on the EtherCAT Slave Terminal Tab Page and select **Coupler Connection (USB) – Online**. Or right-click the Communications Coupler Unit in the Multiview Explorer and select **Coupler Connection (USB) – Online**.
A dialog box to confirm the connection is displayed.
- 4 Check the EtherCAT Coupler Unit to connect to, and click the **OK** Button.
The Sysmac Studio goes online with the EtherCAT Slave Terminal.

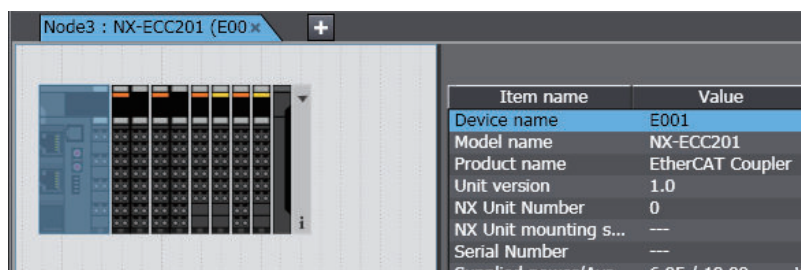

Additional Information

You can also go online by selecting the Communications Coupler Unit in the Slave Terminal and clicking the **Online** Button in the Coupler Connection (USB) item of the Unit setting item list.

A-8-2 Transferring Settings for an EtherCAT Slave Terminal

Use the following procedures to transfer the Slave Terminal settings when the Sysmac Studio is directly connected to an EtherCAT Slave Terminal.

● Transferring Settings from the Computer to the EtherCAT Coupler Unit

- 1 Go online with the EtherCAT Slave Terminal, right-click the Communications Coupler Unit on the EtherCAT Slave Terminal Tab Page and select **Coupler Connection (USB) – Transfer to Coupler**. Or right-click the Communications Coupler Unit in the Multiview Explorer and select **Coupler Connection (USB) – Transfer to Coupler**.

The Transfer to Coupler Dialog Box is displayed.

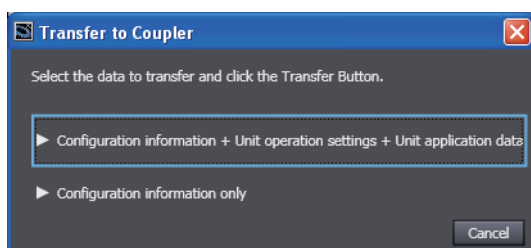

- 2 Click the data to transfer.
A Transfer Confirmation Dialog Box is displayed. Click the **Yes** Button to transfer the data.

● Transferring Settings from the EtherCAT Coupler Unit to the Computer

- 1 Go online with the EtherCAT Slave Terminal, right-click the Communications Coupler Unit on the EtherCAT Slave Terminal Tab Page, and select **Coupler Connection (USB) – Transfer from Coupler**. Or right-click the Communications Coupler Unit in the Multiview Explorer and select **Coupler Connection (USB) – Transfer from Coupler**.
A Transfer Confirmation Dialog Box is displayed. Click the **Yes** Button to transfer the data.



Precautions for Correct Use

If you execute **Transfer to Coupler**, the Unit is restarted after the data is transferred. At that time, I/O communications with the communications master will stop.

A-8-3 Comparing the EtherCAT Slave Terminal Configuration Information

Use the following procedures to compare the Slave Terminal configuration information when the Sysmac Studio is directly connected to the EtherCAT Slave Terminal.

- 1 Go online with the EtherCAT Slave Terminal, right-click the Communications Coupler Unit on the EtherCAT Slave Terminal Tab Page and select **Coupler Connection (USB) – Compare**. Or, right-click the EtherCAT Coupler Unit in the Multiview Explorer and select **Coupler Connection (USB) – Compare**.

The data is compared. If it is the same, *Slave Terminal settings matched* is displayed.

If there are differences, a dialog box that shows the differences in the settings is displayed.

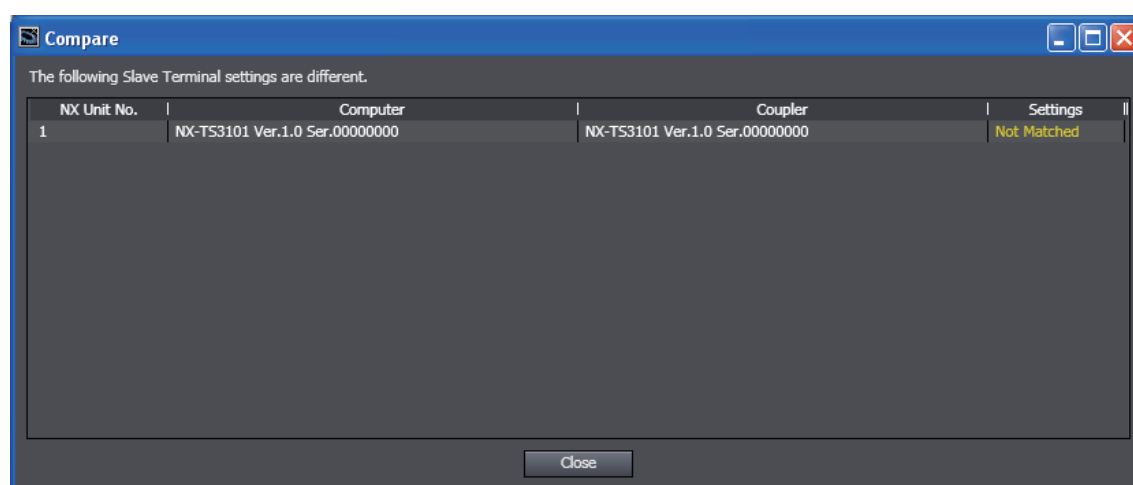

A-8-4 USB Connection Prohibition Setting for EtherCAT Slave Terminals

You can make a setting to prevent a direct USB connection to an operating Slave Terminal to prevent incorrect machine operation that can occur for direct connections to a Slave Terminal during machine operation.

● Prohibition Setting Procedure

- 1 Place the Sysmac Studio online with the NJ/NX/NY-series CPU Unit or the EtherCAT Coupler Unit.
- 2 Double-click the Communications Coupler Unit on the Slave Terminal Tab Page or right-click it and select **Edit Unit Operation Settings**.
The Edit Unit Operation Settings Tab Page is displayed.
- 3 Set the **Preventing Incorrect Operation Setting/USB Connection Prohibition Setting** to *Enable*.

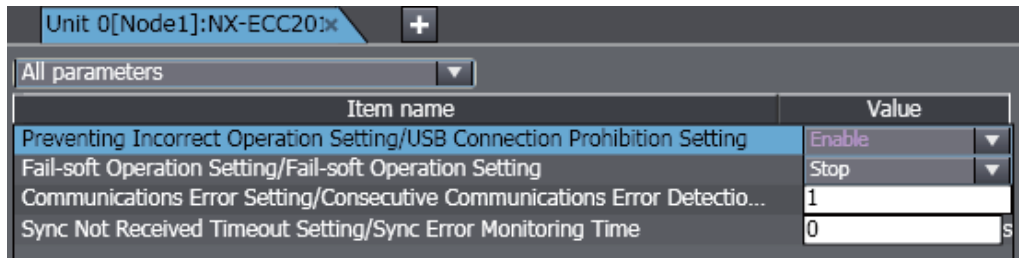

- 4 Click the **Transfer to Unit** Button for the Unit operation settings.
The prohibition setting is enabled after you go offline and then back online.

● Procedure to Clear the Prohibition Setting

- 1 Disconnect the EtherCAT Coupler Unit from the NJ/NX/NY-series CPU Unit or EtherCAT network and place the Sysmac Studio online with the EtherCAT Coupler Unit.
- 2 A Edit Unit Operation Settings Tab Page is displayed for the EtherCAT Coupler Unit.
- 3 Set the **Preventing Incorrect Operation Setting/USB Connection Prohibition Setting** to *Disable*.
- 4 Click the **Transfer to Unit** Button for the Unit operation settings.



Precautions for Correct Use

- You can connect directly to the EtherCAT Coupler Unit even when the prohibition setting is active as long as the EtherCAT Coupler Unit is not connected to the EtherCAT network.
- Sysmac Studio version 1.07 can be directly connected to the Coupler Unit even if the prohibition setting is active.

A-8-5 I/O Wiring Checks for EtherCAT Slave Terminals

This section describes the I/O wiring checks for a direct connection to an EtherCAT Slave Terminal.

All of the following conditions must be met to use this function.

- The EtherCAT Coupler Unit must be disconnected from the EtherCAT network or there must not be a cable connection to the EtherCAT network.
- The Slave Terminal configuration information must be the same between the Sysmac Studio and the Slave Terminal.

● I/O Wiring Check Procedure

- 1 Go online with the EtherCAT Slave Terminal, right-click the Communications Coupler Unit on the EtherCAT Slave Terminal Tab Page, and select **Coupler Connection (USB) – Start I/O Check**. Or, right-click the EtherCAT Coupler Unit in the Multiview Explorer and select **Coupler Connection (USB) – Start I/O Check**.
You can now check the I/O wiring.

- 2 Perform the I/O wiring checks from the I/O Map in the Multiview Explorer. To stop the I/O wiring checks, right-click the EtherCAT Coupler Unit and select **Coupler Connection (USB) – Stop I/O Check**.



Precautions for Safe Use

Do not disconnect the cable when you change the values of I/O ports or variables from the I/O Map with a direct connection to the EtherCAT Coupler Unit. To connect directly to a different Coupler Unit, go offline, connect the cable to the other Unit, and go online again.



Precautions for Correct Use

- An EtherCAT Coupler Unit with unit version 1.2 or later is required to use this function.
- Not all NX Units support this function. Refer to the *NX-series Data Reference Manual (Cat. No. W525)* for details.



A-8-6 Differences in Operation from an Online Connection to an NJ/NX/NY-series Controller

When you are directly connected to an EtherCAT Slave Terminal (i.e., online with the Communications Coupler Unit), the following differences exist in the online operations in comparison to operations when online with the NJ/NX/NY-series Controller.

Operation	Online with Communications Coupler Unit
EtherCAT Network Configuration Compare and Merge	You cannot perform this operation.
Troubleshooting	You cannot monitor user-defined errors or user-defined logs.
Operation authority verification	Operation authority verification does not work.
Menus	Menu commands that you cannot use are grayed out.

Refer to the *NX-series EtherCAT Coupler Units User's Manual (Cat. No. W519)* for details on connecting to the EtherCAT Coupler Unit and online operations.



Additional Information

The USB driver is installed when you connect the first time. Refer to *A-1 Driver Installation for Direct USB Cable Connection* on page A-3 for details.

A-9 MDP Settings for EtherCAT Network Slaves

MDPs (modular device profiles) define data structures for EtherCAT slave settings. They are part of the EtherCAT specifications. You can use slaves that support MDPs from other companies on the EtherCAT Tab Page.



Additional Information

Refer to the manuals provided by the vendors of the MDP slaves and modules for information on the MDP slaves, the modules that you can connect to the MDP slaves, and the settings.

A-9-1 Installing ESI Files for MDP Slaves

- 1 Install the ESI files for the MDP slaves to use on the EtherCAT Tab Page. Refer to *5-2-7 Installing and Uninstalling ESI Files* on page 5-17 for the installation procedure for ESI files.
The MDP slave groups and MDP slave models are displayed in the Toolbox.

A-9-2 Adding MDP Slaves

The procedures to add, delete, and perform other operations for MDP slaves on the EtherCAT Tab Page are the same as those for OMRON slaves. Refer to *5-2 EtherCAT Configuration and Setup* on page 5-4 for the procedures.

A-9-3 Editing Module Configurations

Use the following procedure to register modules for MDP slaves and set those modules.

- 1 Right-click the slave in the EtherCAT Tab Page and select *Edit Module Configuration*. The Module Configuration Dialog Box is displayed.

IPosil	Slot	Module
! Node5 : 750-354 (E001)		
0	Terminals	
1	Terminals	
2	Terminals	
3	Terminals	
4	Terminals	
5	Terminals	
6	Terminals	
7	Terminals	
8	Terminals	

- 2 Select the location at which to register a module and double-click the module to register in the **Toolbox**. Or, drag the module from the **Toolbox** to the Module Configuration Dialog Box. The module is registered.
You can delete, copy, paste, and move modules on the Module Configuration Dialog Box.

To delete all of the modules at the same time, right-click the MDP slave and select **Clear All Settings**.

A-9-4 Building Module Configurations Online

Use the following procedure to automatically create the module configuration on the Sysmac Studio from the actual configuration of the modules.

- 1 Go online, right-click one of the modules in the Module Configuration Dialog Box, and select **Compare and Merge with Actual Module Configuration**.

The actual module configuration is read and compared with the module configuration on the Sysmac Studio. The results are displayed in the **Compare and Merge with Actual Module Configuration** Dialog Box.

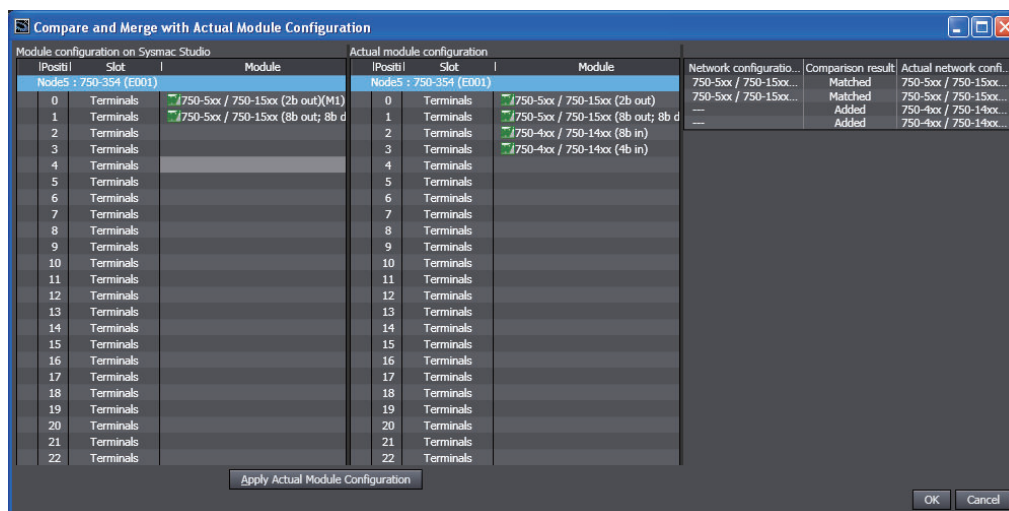

- 2 Click the **Apply Actual Module Configuration** Button to synchronize the module configuration on the Sysmac Studio with the actual module configuration.
- 3 Click the **OK** Button.
The Module Configuration Dialog Box is displayed again.

A-9-5 Setting MDP Slaves and Transferring/Comparing Module Configurations

Setting the MDP slaves and transferring module configuration information are performed in the same ways as with other EtherCAT slaves, i.e., with the synchronization operation. Refer to *Synchronizing (Uploading/Downloading after Automatic Verification)* on page 7-127 for details on the synchronization operation.

A-9-6 Displaying Production Information

Use the following procedure to display production information online for MDP slaves and the modules that are connected to the MDP slaves.

- 1** Go online, right-click one of the modules in the Module Configuration Dialog Box, and select **Display Production Information**.
The Production Information Dialog Box is displayed.

A-10 Changing the Sysmac Studio Display Language

You can use the Language Switching Tool to change the language that is displayed on the Sysmac Studio.

You can select the display language from the languages that are supported by the Sysmac Studio.

A-10-1 Changing the Display Language

- 1 Select **OMRON - Sysmac Studio - Tools - Language Switching Tool** from the Windows Start Menu.
The Language Switching Tool starts.

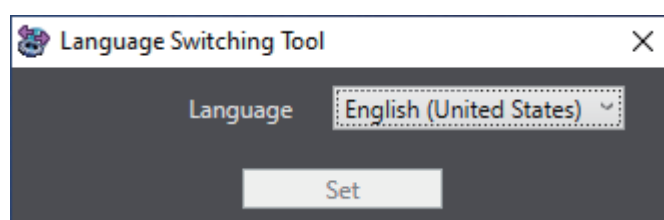

- 2 Select the display language to use, and then click the **Set** Button.
The selected language is used from the next time that the Sysmac Studio starts.



Additional Information

- Changing the display language changes only the language that is displayed on the Sysmac Studio. You cannot change the region that was selected at installation or the Windows region or language setting (local setting).
- For program names, configuration names, and setting names, the language that was used when the project was saved is displayed.

A-11 Changing models among NJ-, NX-, and NY-series Controllers

The settings and the range of values supported by NJ/NX/NY-series Controllers vary depending on the model. This appendix provides precautions for changing among NJ-series, NX-series, and NY-series Controller models:

- Changing between NJ-series and NX701 Controllers
- Changing between NJ-series and NY-series Controllers
- Changing between NY-series and NX701 Controllers
- Changing between NX1P2 and NJ-series Controllers
- Changing between NX1P2 and NX701 Controllers
- Changing between NX1P2 and NY-series Controllers
- Changing between NX102 and NJ-series Controllers
- Changing between NX102 and NX701 Controllers
- Changing between NX102 and NY-series Controllers
- Changing between NX102 and NX1P2 Controllers
- Changing between NX502 and NJ-series Controllers
- Changing between NX502 and NX701 Controllers
- Changing between NX502 and NY-series Controllers
- Changing between NX502 and NX102 Controllers
- Changing between NX502 and NX1P2 Controller

If you change between Controller models not listed here, the set values for functions that are not supported by the Controller that you change to are lost. In this case, the setting items unique to the model that you change to are set to the default values.



Precautions for Safe Use

If the configuration of the EtherCAT network includes an EtherCAT slave that cannot be used by the Controllers after model change, the configuration and settings of the EtherCAT network will be all cleared. In that case, create and set an EtherCAT network configuration again.

A-11-1 Changing between NJ-series and NX701 Controllers

Item		Precautions when changing the Controller model	
		Changing from NJ Series to NX701	Changing from NX701 to NJ Series
EtherCAT Configuration and Setup, and EtherCAT Slave Terminal Configuration and Setup		An EtherCAT configuration and setup that include an EtherCAT Slave Terminal configuration and setup do not change.	<ul style="list-style-type: none"> An error is displayed if the limit to the number of slaves supported by the Controller is exceeded after changing the Controller model. The slave PDO communications cycle settings (PDO Communications Cycle 1 and PDO Communications Cycle 2) are lost. The slaves operate on the primary periodic task period. If a task period that is unique to the NX701 Controller is set, the task period changes when the Controller model is changed, so the value of the PDO communications cycle changes. Refer to <i>Task Settings</i> for information on changes in the task periods.
CPU/Expansion Rack Configuration and Setup		The Unit configuration and the setup parameters for all Units are deleted. All I/O ports are deleted and all variable assignments to I/O ports are deleted.	The CPU/Expansion Rack configuration and setup are added in the same condition as when a new project is created.
Controller Setup	Operation Settings	<ul style="list-style-type: none"> The FINS settings are deleted. Among the general setting items, those unique to the NJ-series Controller are deleted. 	<ul style="list-style-type: none"> The FINS settings are added in the same condition as when a new project is created.
	Built-in EtherNet/IP Port Settings	<ul style="list-style-type: none"> The IP Address settings in the TCP/IP settings are used as the IP Address - Port 1 and Default Gateway settings. The LINK Settings are used for the LINK Settings - Port 1 settings. The FINS settings are deleted. 	<ul style="list-style-type: none"> The IP Address - Port 1 and Default Gateway settings in the TCP/IP settings are used as the IP Address settings. The IP Address - Port 2 settings are lost. Of the data registered for the IP router table in the TCP/IP settings, any data that exceeds the upper limit (8) for an NJ-series Controller is lost. The LINK Settings - Port 1 settings are used for the LINK Settings. The LINK Settings - Port 2 settings are lost. The 1000 Mbps Full Duplex selection is deleted from the selections for the LINK settings. If 1000 Mbps Full Duplex is selected for the NX701 Controller, it changes to Auto.

Item	Precautions when changing the Controller model	
	Changing from NJ Series to NX701	Changing from NX701 to NJ Series
Axis Settings	<i>MC1 (primary periodic task)</i> is assigned to all axis motion controls.	<ul style="list-style-type: none"> An error is displayed if the limit to the number of axes supported by the Controller is exceeded after changing the Controller model. All tasks for devices that are assigned to axes change to the <i>priority-4 primary periodic task</i>. The assigned axis variables for axes that are assigned to <i>MC2 (priority-5 periodic task)</i> in the NX701 Controller change from <code>_MC2_AX[]</code> to <code>_MC_AX[]</code>.
Axes Group Settings	<i>MC1 (primary periodic task)</i> is assigned to all axes group motion controls.	<ul style="list-style-type: none"> An error is displayed if the limit to the number of axes groups supported by the Controller is exceeded after changing the Controller model. The assigned variables for axes groups that are assigned to <i>MC2 (priority-5 periodic task)</i> in the NX701 Controller change from <code>_MC2_GRP[]</code> to <code>_MC_GRP[]</code>.
Task Settings	The task settings do not change.	<ul style="list-style-type: none"> <i>The priority-5 periodic task</i> is deleted. All program assignments to this task are deleted. If a task period that is unique to the NX701 Controllers is set, it changes to the nearest settable NJ-series Controller task period that is not smaller than the original task period. The results of the change are displayed in the Output Tab Page.
EtherNet/IP Connection Settings	<ul style="list-style-type: none"> The connection settings in the Built-in EtherNet/IP Port Settings are used for the Built-in EtherNet/IP Port Settings - Port 1 settings. If a CJ-series EtherNet/IP Unit is registered, the connection setting to it is lost. 	The connection settings in the Built-in EtherNet/IP Port Settings - Port 1 settings are used for the Built-in EtherNet/IP Port Settings . The Built-in EtherNet/IP Port Settings - Port 2 settings are lost.

A-11-2 Changing between NJ-series and NY-series Controllers

Item	Precautions when changing the Controller model	
	Changing from NJ Series to NY Series	Changing from NY Series to NJ Series
EtherCAT Configuration and Setup, and EtherCAT Slave Terminal Configuration and Setup	An EtherCAT configuration and setup that include an EtherCAT Slave Terminal configuration and setup do not change.	If a task period that is unique to the NY-series Controller is set, the task period changes when the Controller model is changed, so the value of the PDO communications cycle changes. Refer to <i>Task Settings</i> for information on changes in the task periods.

Item		Precautions when changing the Controller model	
		Changing from NJ Series to NY Series	Changing from NY Series to NJ Series
CPU/Expansion Rack Configuration and Setup		The Unit configuration and the setup parameters for all Units are deleted. All I/O ports are deleted and all variable assignments to I/O ports are deleted.	The CPU/Expansion Rack configuration and setup are added in the same condition as when a new project is created.
Controller Setup	Operation Settings	<ul style="list-style-type: none"> The FINS settings are deleted. Among the general setting items, those unique to the NJ-series Controller are deleted. 	<ul style="list-style-type: none"> The FINS settings are added in the same condition as when a new project is created. Among the general setting items, those unique to the NY-series Controller are deleted.
	Built-in EtherNet/IP Port Settings	<ul style="list-style-type: none"> The IP Address settings in the TCP/IP settings are used as the IP Address - EtherNet/IP Port and Default Gateway settings. The LINK Settings are used for the LINK Settings - EtherNet/IP Port settings. The FINS settings are deleted. The internal port 1 is added in the same condition as when a new project is created. 	<ul style="list-style-type: none"> The IP Address - EtherNet/IP Port and Default Gateway settings in the TCP/IP settings are used as the IP Address - Internal Port 1 settings are lost. Of the data registered for the IP router table in the TCP/IP settings, any data that exceeds the upper limit (8) for an NJ-series Controller is lost. The LINK Settings - EtherNet/IP Port settings are used for the LINK Settings. The 1000 Mbps Full Duplex selection is deleted from the selections for the LINK settings. If 1000 Mbps Full Duplex is selected for the NY-series Controller, it changes to Auto.
Task Settings		The task settings do not change.	If a task period that is unique to the NY-series Controllers is set, it changes to the nearest settable NJ-series Controller task period that is not smaller than the original task period. The results of the change are displayed in the Output Tab Page.

A-11-3 Changing between NY-series and NX701 Controllers

Item		Precautions when changing the Controller model	
		Changing from NY Series to NX701	Changing from NX701 to NY Series
EtherCAT Configuration and Setup, and EtherCAT Slave Terminal Configuration and Setup		An EtherCAT configuration and setup that include an EtherCAT Slave Terminal configuration and setup do not change.	<ul style="list-style-type: none"> An error is displayed if the limit to the number of slaves supported by the Controller is exceeded after changing the Controller model. The PDO Communications Cycle 2 setting for slaves is lost. The PDO Communications Cycle 1 for slaves is set to the primary periodic task period. If a task period that is unique to the NX701 Controller is set, the task period changes when the Controller model is changed, so the value of the PDO communications cycle changes. Refer to <i>Task Settings</i> for information on changes in the task periods.
Controller Setup	Operation Settings	Among the general setting items, those unique to the NY-series Controller are deleted.	Among the general setting items, those unique to the NX701 Controller are deleted.
	Built-in EtherNet/IP Port Settings	<ul style="list-style-type: none"> The IP Address - EtherNet/IP Port settings in the TCP/IP settings are used as the IP Address - Port 1 settings. The IP Address - Internal Port 1 settings are lost. The LINK Settings are used for the LINK Settings - Port 1 settings. The FINS settings are deleted. 	<ul style="list-style-type: none"> The IP Address - Port 1 settings in the TCP/IP settings are used as the IP Address - EtherNet/IP Port settings. The IP Address - Port 2 settings are lost. The LINK Settings - Port 1 settings are used for the LINK Settings. The LINK Settings - Port 2 settings are lost.
Axis Settings		<i>MC1 (primary periodic task)</i> is assigned to all axis motion controls.	<ul style="list-style-type: none"> An error is displayed if the limit to the number of axes supported by the Controller is exceeded after changing the Controller model. All tasks for devices that are assigned to axes change to the priority-4 primary periodic task. The assigned axis variables for axes that are assigned to MC2 (priority-5 periodic task) in the NX701 Controller change from <code>_MC2_AX[□]</code> to <code>_MC_AX[□]</code>.
Axes Group Settings		<i>MC1 (primary periodic task)</i> is assigned to all axes group motion controls.	<ul style="list-style-type: none"> An error is displayed if the limit to the number of axes groups supported by the Controller is exceeded after changing the Controller model. The assigned variables for axes groups that are assigned to MC2 (priority-5 primary periodic task) in the NX701 Controller change from <code>_MC2_GRP[□]</code> to <code>_MC_GRP[□]</code>.

Item	Precautions when changing the Controller model	
	Changing from NY Series to NX701	Changing from NX701 to NY Series
Task Settings	The task settings do not change.	<ul style="list-style-type: none"> The priority-5 periodic task is deleted. All program assignments to this task are deleted. If a task period that is unique to the NX701 Controllers is set, it changes to the nearest settable NY-series Controller task period that is not smaller than the original task period. The results of the change are displayed in the Output Tab Page.
EtherNet/IP Connection Settings	<ul style="list-style-type: none"> The connection settings in the Built-in EtherNet/IP Port Settings are used for the Built-in EtherNet/IP Port Settings - Port 1 settings. 	The connection settings in the Built-in EtherNet/IP Port Settings - Port 1 settings are used for the Built-in EtherNet/IP Port Settings . The Built-in EtherNet/IP Port Settings - Port 2 settings are lost.

A-11-4 Changing between NX1P2 and NJ-series Controllers

Item	Precautions when changing the Controller model	
	Changing from NX1P2 to NJ Series	Changing from NJ Series to NX1P2
EtherCAT Configuration and Setup, and EtherCAT Slave Terminal Configuration and Setup	If a task period that is unique to the NX1P2 Controller is set, the task period changes when the Controller model is changed, so the value of the PDO communications cycle changes. Refer to <i>Task Settings</i> for information on changes in the task periods.	<ul style="list-style-type: none"> An error is displayed if the limit to the number of slaves supported by the Controller is exceeded after changing the Controller model. An EtherCAT configuration and setup that include an EtherCAT Slave Terminal configuration and setup do not change. If a task period that is unique to the NJ-series Controller is set, the task period changes when the Controller model is changed, so the value of the PDO communications cycle changes. Refer to <i>Task Settings</i> for information on changes in the task periods.
CPU/Expansion Rack Configuration and Setup	The Unit configuration and the setup parameters for all Units are deleted. All I/O ports are deleted and all variable assignments to I/O ports are deleted.	The Unit configuration and the setup parameters for all Units are deleted. All I/O ports are deleted and all variable assignments to I/O ports are deleted.

Item		Precautions when changing the Controller model	
		Changing from NX1P2 to NJ Series	Changing from NJ Series to NX1P2
Controller Setup	Operation Settings	<ul style="list-style-type: none"> Among the general setting items, those unique to the NX1P2 Controller are deleted. 	<ul style="list-style-type: none"> Among the general setting items, those unique to the NJ-series Controller are deleted. In this case, the setting items unique to the NX1P2 Controller are set to the default values.
	Built-in EtherNet/IP Port Settings	<ul style="list-style-type: none"> The IP Address and Default Gateway settings in the TCP/IP settings are used as the IP Address settings. 	<ul style="list-style-type: none"> The IP Address settings in the TCP/IP settings are used as the IP Address and Default Gateway settings. Among the FINS settings, the FINS/TCP settings are deleted.
Axis Settings		<ul style="list-style-type: none"> The Control Function parameter setting for the NX1P2 Controller is deleted. An error is displayed if the limit to the number of axes supported by the Controller is exceeded after changing the Controller model. 	<ul style="list-style-type: none"> An error is displayed if the limit to the number of axes supported by the Controller is exceeded after changing the Controller model. <i>MC1 (primary periodic task)</i> is assigned to all axis motion controls. The Control Function parameter is set to <i>All</i>.
Axes Group Settings		An error is displayed if the limit to the number of axes groups supported by the Controller is exceeded after changing the Controller model.	<ul style="list-style-type: none"> <i>MC1 (primary periodic task)</i> is assigned to all axes group motion controls. An error is displayed if the limit to the number of axes groups supported by the Controller is exceeded after changing the Controller model.
Task Settings		If a task period that is unique to the NX1P2 Controller is set, it changes to the nearest settable NJ-series Controller task period that is not smaller than the original task period. The results of the change are displayed in the Output Tab Page.	<ul style="list-style-type: none"> The priority-16 periodic task is deleted. All program assignments to this task are deleted. If a task period that is unique to the NJ-series Controllers is set, it changes to the nearest settable NX1P2 Controller task period that is not smaller than the original task period. The results of the change are displayed in the Output Tab Page.

A-11-5 Changing between NX1P2 and NX701 Controllers

Item		Precautions when changing the Controller model	
		Changing from NX1P2 to NX701	Changing from NX701 to NX1P2
EtherCAT Configuration and Setup, and EtherCAT Slave Terminal Configuration and Setup		An EtherCAT configuration and setup that include an EtherCAT Slave Terminal configuration and setup do not change.	<ul style="list-style-type: none"> An error is displayed if the limit to the number of slaves supported by the Controller is exceeded after changing the Controller model. The PDO Communications Cycle 2 setting for slaves is lost. The PDO Communications Cycle 1 for slaves is set to the primary periodic task period. If a task period that is unique to the NX701 Controller is set, the task period changes when the Controller model is changed, so the value of the PDO communications cycle changes. Refer to <i>Task Settings</i> for information on changes in the task periods.
CPU/Expansion Rack Configuration and Setup		The Unit configuration and the setup parameters for all Units are deleted. All I/O ports are deleted and all variable assignments to I/O ports are deleted.	The CPU/Expansion Rack configuration and setup are added in the same condition as when a new project is created.
Controller Setup	Operation Settings	Among the general setting items, those unique to the NX1P2 Controller are deleted.	Among the general setting items, those unique to the NX701 Controller are deleted.
	Built-in EtherNet/IP Port Settings	<ul style="list-style-type: none"> The IP Address settings in the TCP/IP settings are used as the IP Address - Port 1 settings. The LINK Settings are used for the LINK Settings - Port 1 settings. The FINS settings are deleted. 	<ul style="list-style-type: none"> The IP Address - Port 1 settings in the TCP/IP settings are used as the IP Address settings. The IP Address - Port 2 settings are lost. Of the data registered for the IP router table in the TCP/IP settings, any data that exceeds the upper limit (8) for an NX1P2 Controller is lost. The LINK Settings - Port 1 settings are used for the LINK Settings. The LINK Settings - Port 2 settings are lost. The 1000 Mbps Full Duplex selection is deleted from the selections for the LINK settings. If 1000 Mbps Full Duplex is selected for the NX701 Controller, it changes to Auto.

Item	Precautions when changing the Controller model	
	Changing from NX1P2 to NX701	Changing from NX701 to NX1P2
Axis Settings	The Control Function parameter setting for the NX1P2 Controller is deleted.	<ul style="list-style-type: none"> An error is displayed if the limit to the number of axes supported by the Controller is exceeded after changing the Controller model. All tasks for devices that are assigned to axes change to the priority-4 primary periodic task. The assigned axis variables for axes that are assigned to MC2 (priority-5 periodic task) in the NX701 Controller change from <code>_MC2_AX[□]</code> to <code>_MC_AX[□]</code>. The Control Function parameter is set to <i>All</i>.
Axes Group Settings	The axes group settings do not change.	<ul style="list-style-type: none"> An error is displayed if the limit to the number of axes groups supported by the Controller is exceeded after changing the Controller model. The assigned variables for axes groups that are assigned to MC2 (priority-5 primary periodic task) in the NX701 Controller change from <code>_MC2_GRP[□]</code> to <code>_MC_GRP[□]</code>.
Task Settings	The task settings do not change.	<ul style="list-style-type: none"> The priority-5 and priority-16 periodic tasks are deleted. All program assignments to this task are deleted. If a task period that is unique to the NX701 Controller is set, it changes to the nearest settable NX1P2 Controller task period that is not smaller than the original task period. The results of the change are displayed in the Output Tab Page.
EtherNet/IP Connection Settings	<ul style="list-style-type: none"> The connection settings in the Built-in EtherNet/IP Port Settings are used for the Built-in EtherNet/IP Port Settings - Port 1 settings. 	The connection settings in the Built-in EtherNet/IP Port Settings - Port 1 settings are used for the Built-in EtherNet/IP Port Settings . The Built-in EtherNet/IP Port Settings - Port 2 settings are lost.

A-11-6 Changing between NX1P2 and NY-series Controllers

Item		Precautions when changing the Controller model	
		Changing from NX1P2 to NY Series	Changing from NY Series to NX1P2
EtherCAT Configuration and Setup, and EtherCAT Slave Terminal Configuration and Setup		<ul style="list-style-type: none"> An EtherCAT configuration and setup that include an EtherCAT Slave Terminal configuration and setup do not change. 	<ul style="list-style-type: none"> An error is displayed if the limit to the number of slaves supported by the Controller is exceeded after changing the Controller model. If a task period that is unique to the NY-series Controller is set, the task period changes when the Controller model is changed, so the value of the PDO communications cycle changes. Refer to <i>Task Settings</i> for information on changes in the task periods.
CPU/Expansion Rack Configuration and Setup		The Unit configuration and the setup parameters for all Units are deleted. All I/O ports are deleted and all variable assignments to I/O ports are deleted.	The CPU/Expansion Rack configuration and setup are added in the same condition as when a new project is created.
Controller Setup	Operation Settings	Among the general setting items, those unique to the NX1P2 Controller are deleted.	Among the general setting items, those unique to the NY-series Controller are deleted.
	Built-in EtherNet/IP Port Settings	<ul style="list-style-type: none"> The IP Address settings in the TCP/IP settings are used as the IP Address - EtherNet/IP Port settings. The LINK Settings are used for the LINK Settings - EtherNet/IP Port settings. 	<ul style="list-style-type: none"> The IP Address - EtherNet/IP Port settings in the TCP/IP settings are used as the IP Address settings. The IP Address - Internal Port 1 settings are lost. Of the data registered for the IP router table in the TCP/IP settings, any data that exceeds the upper limit (8) for an NX1P2 Controller is lost. The LINK Settings - EtherNet/IP Port settings are used for the LINK Settings. The 1000 Mbps Full Duplex selection is deleted from the selections for the LINK settings. If 1000 Mbps Full Duplex is selected for the NY-series Controller, it changes to Auto.
Axis Settings		The Control Function parameter setting for the NX1P2 Controller is deleted.	<ul style="list-style-type: none"> An error is displayed if the limit to the number of axes supported by the Controller is exceeded after changing the Controller model. The Control Function parameter is set to <i>All</i>.
Axes Group Settings		The axes group settings do not change.	An error is displayed if the limit to the number of axes groups supported by the Controller is exceeded after changing the Controller model.

Item	Precautions when changing the Controller model	
	Changing from NX1P2 to NY Series	Changing from NY Series to NX1P2
Task Settings	The task settings do not change.	<ul style="list-style-type: none"> The priority-16 periodic task is deleted. All program assignments to this task are deleted. If a task period that is unique to the NY-series Controllers is set, it changes to the nearest settable NX1P2 Controller task period that is not smaller than the original task period. The results of the change are displayed in the Output Tab Page.

A-11-7 Changing between NX102 and NJ-series Controllers

Item	Precautions when changing the Controller model	
	Changing from NX102 to NJ Series	Changing from NJ Series to NX102
EtherCAT Configuration and Setup, and EtherCAT Slave Terminal Configuration and Setup	If a task period that is unique to the NX102 Controller is set, the task period changes when the Controller model is changed, so the value of the PDO communications cycle changes. Refer to <i>Task Settings</i> for information on changes in the task periods.	<ul style="list-style-type: none"> An error is displayed if the limit to the number of slaves supported by the Controller is exceeded after changing the Controller model. An EtherCAT configuration and setup that include an EtherCAT Slave Terminal configuration and setup do not change. If a task period that is unique to the NJ-series Controller is set, the task period changes when the Controller model is changed, so the value of the PDO communications cycle changes. Refer to <i>Task Settings</i> for information on changes in the task periods.
CPU/Expansion Rack Configuration and Setup	The Unit configuration and the setup parameters for all Units are deleted. All I/O ports are deleted and all variable assignments to I/O ports are deleted.	The Unit configuration and the setup parameters for all Units are deleted. All I/O ports are deleted and all variable assignments to I/O ports are deleted.

Item		Precautions when changing the Controller model	
		Changing from NX102 to NJ Series	Changing from NJ Series to NX102
Controller Setup	Operation Settings	<ul style="list-style-type: none"> Among the general setting items, those unique to the NX102 Controller are deleted. 	<ul style="list-style-type: none"> Among the general setting items, those unique to the NJ-series Controller are deleted. In this case, the setting items unique to the NX102 Controller are set to the default values.
	Built-in EtherNet/IP Port Settings	<ul style="list-style-type: none"> The IP Address - Port 1 and Default Gateway settings in the TCP/IP settings are used as the IP Address settings. The IP Address - Port 2 settings are lost. Among the data registered for the IP router table in the TCP/IP settings, any data that exceeds the upper limit (8) for an NJ-series Controller is lost. The LINK Settings - Port 1 settings are used for the LINK Settings. The LINK Settings - Port 2 settings are lost. For the FINS Node Address setting in FINS Settings, the value for the built-in EtherNet/IP port 1 is set as the value for the Built-in EtherNet/IP Port. 	<ul style="list-style-type: none"> The IP Address settings in the TCP/IP settings are used as the IP Address - Port 1 and Default Gateway settings.
Axis Settings		<ul style="list-style-type: none"> The Control Function parameter setting for the NX102 Controller is deleted. An error is displayed if the limit to the number of axes supported by the Controller is exceeded after changing the Controller model. 	<ul style="list-style-type: none"> An error is displayed if the limit to the number of axes supported by the Controller is exceeded after changing the Controller model. <i>MC1 (primary periodic task)</i> is assigned to all axis motion controls. The Control Function parameter is set to <i>All</i>.
Axes Group Settings		An error is displayed if the limit to the number of axes groups supported by the Controller is exceeded after changing the Controller model.	<ul style="list-style-type: none"> <i>MC1 (primary periodic task)</i> is assigned to all axes group motion controls. An error is displayed if the limit to the number of axes groups supported by the Controller is exceeded after changing the Controller model.
Task Settings		If a task period that is unique to the NX102 Controllers is set, it changes to the nearest settable NJ-series Controller task period that is not smaller than the original task period. The results of the change are displayed in the Output Tab Page.	<ul style="list-style-type: none"> The priority-16 periodic task is deleted. All program assignments to this task are deleted. If a task period that is unique to the NJ-series Controllers is set, it changes to the nearest settable NX102 Controller task period that is not smaller than the original task period. The results of the change are displayed in the Output Tab Page.

Item	Precautions when changing the Controller model	
	Changing from NX102 to NJ Series	Changing from NJ Series to NX102
EtherNet/IP Connection Settings	The connection settings in the Built-in EtherNet/IP Port Settings - Port 1 settings are used for the Built-in EtherNet/IP Port Settings - Port 2 settings are lost.	<ul style="list-style-type: none"> The connection settings in the Built-in EtherNet/IP Port Settings are used for the Built-in EtherNet/IP Port Settings - Port 1 settings. If a CJ-series EtherNet/IP Unit is registered, the connection setting to it is lost.

A-11-8 Changing between NX102 and NX701 Controllers

Item	Precautions when changing the Controller model		
	Changing from NX102 to NX701	Changing from NX701 to NX102	
EtherCAT Configuration and Setup, and EtherCAT Slave Terminal Configuration and Setup	An EtherCAT configuration and setup that include an EtherCAT Slave Terminal configuration and setup do not change.	<ul style="list-style-type: none"> An error is displayed if the limit to the number of slaves supported by the Controller is exceeded after changing the Controller model. The PDO Communications Cycle 2 setting for slaves is lost. The PDO Communications Cycle 1 for slaves is set to the primary periodic task period. If a task period that is unique to the NX701 Controller is set, the task period changes when the Controller model is changed, so the value of the PDO communications cycle changes. Refer to <i>Task Settings</i> for information on changes in the task periods. 	
CPU/Expansion Rack Configuration and Setup	The Unit configuration and the setup parameters for all Units are deleted. All I/O ports are deleted and all variable assignments to I/O ports are deleted.	The CPU/Expansion Rack configuration and setup are added in the same condition as when a new project is created.	
Controller Setup	Operation Settings	Among the general setting items, those unique to the NX102 Controller are deleted.	Among the general setting items, those unique to the NX701 Controller are deleted.
	Built-in EtherNet/IP Port Settings	When the model is changed to a model without FINS Settings, the FINS Settings will be deleted.	<ul style="list-style-type: none"> Of the data registered for the IP router table in the TCP/IP settings, any data that exceeds the upper limit (64) for an NX102 Controller is lost. The 1000 Mbps Full Duplex selection is deleted from the selections for the LINK settings. If 1000 Mbps Full Duplex is selected for the NX701 Controller, it changes to Auto.
	Memory Settings	Even when the model is changed to a model with Memory Settings , the data in the Memory Settings is initialized and it is not inherited.	Even when the model is changed from a model with Memory Settings , the data in the Memory Settings is initialized and it is not inherited.

Item	Precautions when changing the Controller model	
	Changing from NX102 to NX701	Changing from NX701 to NX102
Axis Settings	The Control Function parameter setting for the NX102 Controller is deleted.	<ul style="list-style-type: none"> An error is displayed if the limit to the number of axes supported by the Controller is exceeded after changing the Controller model. All tasks for devices that are assigned to axes change to the priority-4 primary periodic task. The assigned axis variables for axes that are assigned to MC2 (priority-5 periodic task) in the NX701 Controller change from <code>_MC2_AX[]</code> to <code>_MC_AX[]</code>. The Control Function parameter is set to <i>All</i>.
Axes Group Settings	The axes group settings do not change.	<ul style="list-style-type: none"> An error is displayed if the limit to the number of axes groups supported by the Controller is exceeded after changing the Controller model. The assigned variables for axes groups that are assigned to MC2 (priority-5 primary periodic task) in the NX701 Controller change from <code>_MC2_GRP[]</code> to <code>_MC_GRP[]</code>.
Task Settings	If a task period that is unique to the NX102 Controller is set, it changes to the nearest settable NX701 Controller task period that is not smaller than the original task period.	<ul style="list-style-type: none"> The priority-5 and priority-16 periodic tasks are deleted. All program assignments to this task are deleted. If a task period that is unique to the NX701 Controller is set, it changes to the nearest settable NX102 Controller task period that is not smaller than the original task period. The results of the change are displayed in the Output Tab Page.

A-11-9 Changing between NX102 and NY-series Controllers

Item	Precautions when changing the Controller model	
	Changing from NX102 to NY Series	Changing from NY Series to NX102
EtherCAT Configuration and Setup, and EtherCAT Slave Terminal Configuration and Setup	<ul style="list-style-type: none"> An EtherCAT configuration and setup that include an EtherCAT Slave Terminal configuration and setup do not change. 	<ul style="list-style-type: none"> An error is displayed if the limit to the number of slaves supported by the Controller is exceeded after changing the Controller model. If a task period that is unique to the NY-series Controller is set, the task period changes when the Controller model is changed, so the value of the PDO communications cycle changes. Refer to <i>Task Settings</i> for information on changes in the task periods.

Item		Precautions when changing the Controller model	
		Changing from NX102 to NY Series	Changing from NY Series to NX102
CPU/Expansion Rack Configuration and Setup		The Unit configuration and the setup parameters for all Units are deleted. All I/O ports are deleted and all variable assignments to I/O ports are deleted.	The CPU/Expansion Rack configuration and setup are added in the same condition as when a new project is created.
Controller Setup	Operation Settings	Among the general setting items, those unique to the NX102 Controller are deleted.	Among the general setting items, those unique to the NY-series Controller are deleted.
	Built-in EtherNet/IP Port Settings	<ul style="list-style-type: none"> The IP Address - Port 1 settings in the TCP/IP settings are used as the IP Address - EtherNet/IP Port settings. The IP Address - Port 2 settings are lost. The LINK Settings - Port 1 settings are used for the LINK Settings. The LINK Settings - Port 2 settings are lost. 	<ul style="list-style-type: none"> The IP Address - EtherNet/IP Port settings in the TCP/IP settings are used as the IP Address - Port 1 settings. The IP Address - Internal Port 1 settings are lost. The LINK Settings are used for the LINK Settings - Port 1 settings. Of the data registered for the IP router table in the TCP/IP settings, any data that exceeds the upper limit (64) for an NX102 Controller is lost. The 1000 Mbps Full Duplex selection is deleted from the selections for the LINK settings. If 1000 Mbps Full Duplex is selected for the NY-series Controller, it changes to Auto.
Axis Settings		The Control Function parameter setting for the NX102 Controller is deleted.	<ul style="list-style-type: none"> An error is displayed if the limit to the number of axes supported by the Controller is exceeded after changing the Controller model. The Control Function parameter is set to <i>All</i>.
Axes Group Settings		The axes group settings do not change.	An error is displayed if the limit to the number of axes groups supported by the Controller is exceeded after changing the Controller model.
Task Settings		If a task period that is unique to the NX102 Controllers is set, it changes to the nearest settable NY-series Controller task period that is not smaller than the original task period.	<ul style="list-style-type: none"> The priority-16 periodic task is deleted. All program assignments to this task are deleted. If a task period that is unique to the NY-series Controllers is set, it changes to the nearest settable NX102 Controller task period that is not smaller than the original task period. The results of the change are displayed in the Output Tab Page.
EtherNet/IP Connection Settings		The connection settings in the Built-in EtherNet/IP Port Settings - Port 1 settings are used for the Built-in EtherNet/IP Port Settings . The Built-in EtherNet/IP Port Settings - Port 2 settings are lost.	The connection settings in the Built-in EtherNet/IP Port Settings are used for the Built-in EtherNet/IP Port Settings - Port 1 settings.

A-11-10 Changing between NX102 and NX1P2 Controllers

Item		Precautions when changing the Controller model	
		Changing from NX102 to NX1P2	Changing from NX1P2 to NX102
EtherCAT Configuration and Setup, and EtherCAT Slave Terminal Configuration and Setup		<ul style="list-style-type: none"> An error is displayed if the limit to the number of slaves supported by the Controller is exceeded after changing the Controller model. If a task period that is unique to the NX102 Controller is set, the task period changes when the Controller model is changed, so the value of the PDO communications cycle changes. Refer to <i>Task Settings</i> for information on changes in the task periods. 	An EtherCAT configuration and setup that include an EtherCAT Slave Terminal configuration and setup do not change.
CPU/Expansion Rack Configuration and Setup		The Unit configuration and the setup parameters are used. An error is displayed if the limit to the number of Units supported by the Controller is exceeded after changing the Controller series.	The Unit configuration and the setup parameters are used.
Controller Setup	Operation Settings	Among the general setting items, those unique to the NX102 Controller are deleted.	Among the general setting items, those unique to the NX1P2 Controller are deleted.
	Built-in EtherNet/IP Port Settings	<ul style="list-style-type: none"> The IP Address - Port 1 settings in the TCP/IP settings are used as the IP Address settings. The IP Address - Port 2 settings are lost. Of the data registered for the IP router table in the TCP/IP settings, any data that exceeds the upper limit (8) for an NX1P2 Controller is lost. The LINK Settings - Port 1 settings are used for the LINK Settings. The LINK Settings - Port 2 settings are lost. Among the FINS settings, the FINS/TCP settings are deleted. 	<ul style="list-style-type: none"> The IP Address settings in the TCP/IP settings are used as the IP Address - Port 1 settings. The LINK Settings are used for the LINK Settings - Port 1 settings.
	Memory Settings	The data in the Memory Settings is initialized and it is not inherited.	The data in the Memory Settings is initialized and it is not inherited.
Axis Settings		An error is displayed if the limit to the number of axes supported by the Controller is exceeded after changing the Controller model.	An error is displayed if the limit to the number of axes supported by the Controller is exceeded after changing the Controller model.
Axes Group Settings		An error is displayed if the limit to the number of axes groups supported by the Controller is exceeded after changing the Controller model.	An error is displayed if the limit to the number of axes groups supported by the Controller is exceeded after changing the Controller model.

Item	Precautions when changing the Controller model	
	Changing from NX102 to NX1P2	Changing from NX1P2 to NX102
Task Settings	If a task period that is unique to the NX102 Controller is set, it changes to the nearest settable NX1P2 Controller task period that is not smaller than the original task period. The results of the change are displayed in the Output Tab Page.	The task settings do not change.
EtherNet/IP Connection Settings	The connection settings in the Built-in EtherNet/IP Port Settings - Port 1 settings are used for the Built-in EtherNet/IP Port Settings . The Built-in EtherNet/IP Port Settings - Port 2 settings are lost.	The connection settings in the Built-in EtherNet/IP Port Settings are used for the Built-in EtherNet/IP Port Settings - Port 1 settings.

A-11-11 Changing between NX502 and NJ-series Controllers

Item	Precautions when changing the Controller model	
	Changing from NX502 to NJ Series	Changing from NJ Series to NX502
EtherCAT Configuration and Setup, and EtherCAT Slave Terminal Configuration and Setup	If a task period that is unique to the NX502 Controller is set, the task period changes when the Controller model is changed, so the value of the PDO communications cycle changes. Refer to <i>Task Settings</i> for information on changes in the task periods.	<ul style="list-style-type: none"> An error is displayed if the limit to the number of slaves supported by the Controller is exceeded after changing the Controller model. The EtherCAT configuration and setup that include the EtherCAT Slave Terminal configuration and setup do not change. If a task period that is unique to the NJ-series Controller is set, the task period changes when the Controller model is changed, so the value of the PDO communications cycle changes. Refer to <i>Task Settings</i> for information on changes in the task periods.
CPU/Expansion Rack Configuration and Setup	The Unit configuration and the setup parameters for all Units are deleted. All I/O ports are deleted and all variable assignments to I/O ports are deleted.	The Unit configuration and the setup parameters for all Units are deleted. All I/O ports are deleted and all variable assignments to I/O ports are deleted.

Item		Precautions when changing the Controller model	
		Changing from NX502 to NJ Series	Changing from NJ Series to NX502
Controller Setup	Operation Settings	<ul style="list-style-type: none"> Among the general setting items, those unique to the NX502 Controller are deleted. 	<ul style="list-style-type: none"> Among the general setting items, those unique to the NJ-series Controller are deleted. In this case, the setting items unique to the NX502 Controller are set to the default values.
	Built-in EtherNet/IP Port Settings	<ul style="list-style-type: none"> The IP Address - Port 1 and Default Gateway settings in the TCP/IP settings are used as the IP Address settings. The IP Address - Port 2 settings are lost. Among the data registered for the IP router table in the TCP/IP settings, any data that exceeds the upper limit (8) for an NJ-series Controller is lost. The LINK Settings - Port 1 settings are used for the LINK Settings. The LINK Settings - Port 2 settings are lost. For the <i>FINS Node Address Settings</i> in FINS Settings, the value for the built-in EtherNet/IP port 1 is set as the value for the Built-in EtherNet/IP Port. 	<ul style="list-style-type: none"> The IP Address settings in the TCP/IP settings are used as the IP Address - Port 1 and Default Gateway settings.
Axis Settings		An error is displayed if the limit to the number of axes supported by the Controller is exceeded after changing the Controller model.	<ul style="list-style-type: none"> An error is displayed if the limit to the number of axes supported by the Controller is exceeded after changing the Controller model. <i>MC1 (primary periodic task)</i> is assigned to all axis motion controls. The Control Function parameter is set to <i>All</i>.
Axes Group Settings		An error is displayed if the limit to the number of axes groups supported by the Controller is exceeded after changing the Controller model.	<ul style="list-style-type: none"> <i>MC1 (primary periodic task)</i> is assigned to all axes group motion controls. An error is displayed if the limit to the number of axes groups supported by the Controller is exceeded after changing the Controller model.
Task Settings		If a task period that is unique to the NX502 Controllers is set, it changes to the nearest settable NJ-series Controller task period that is not smaller than the original task period. The results of the change are displayed in the Output Tab Page.	<ul style="list-style-type: none"> The <i>priority-16 periodic task</i> is deleted. All program assignments to this task are deleted. If a task period that is unique to the NJ-series Controllers is set, it changes to the nearest settable NX502 Controller task period that is not smaller than the original task period. The results of the change are displayed in the Output Tab Page.

Item	Precautions when changing the Controller model	
	Changing from NX502 to NJ Series	Changing from NJ Series to NX502
EtherNet/IP Connection Settings	The connection settings in the Built-in EtherNet/IP Port Settings - Port 1 settings are used for the Built-in EtherNet/IP Port Settings - Port 2 settings are lost.	<ul style="list-style-type: none"> The connection settings in the Built-in EtherNet/IP Port Settings are used for the Built-in EtherNet/IP Port Settings - Port 1 settings. If a CJ-series EtherNet/IP Unit is registered, its connection setting is lost.
DB Connection Settings	When the model is changed to a model with DB connection settings, the DB connection settings do not change. When the model is changed to a model without DB connection settings, the DB connection settings are deleted.	When the model is changed from a model with DB connection settings, the DB connection settings do not change.

A-11-12 Changing between NX502 and NX701 Controllers

Item	Precautions when changing the Controller model	
	Changing from NX502 to NX701	Changing from NX701 to NX502
EtherCAT Configuration and Setup, and EtherCAT Slave Terminal Configuration and Setup	The EtherCAT configuration and setup that include the EtherCAT Slave Terminal configuration and setup do not change.	<ul style="list-style-type: none"> An error is displayed if the limit to the number of slaves supported by the Controller is exceeded after changing the Controller model. The PDO Communications Cycle 2 setting for slaves is lost. The PDO Communications Cycle 1 for slaves is set to the primary periodic task period. If a task period that is unique to the NX701 Controller is set, the task period changes when the Controller model is changed, so the value of the PDO communications cycle changes. Refer to <i>Task Settings</i> for information on changes in the task periods.
CPU/Expansion Rack Configuration and Setup	The Unit configuration and the setup parameters for all Units are deleted. All I/O ports are deleted and all variable assignments to I/O ports are deleted.	The CPU/Expansion Rack configuration and setup are added in the same condition as when a new project is created.

Item		Precautions when changing the Controller model	
		Changing from NX502 to NX701	Changing from NX701 to NX502
Controller Setup	Operation Settings	Among the general setting items, those unique to the NX502 Controller are deleted.	Among the general setting items, those unique to the NX701 Controller are deleted.
	Built-in EtherNet/IP Port Settings	When the model is changed to a model without FINS settings, the FINS settings are deleted.	<ul style="list-style-type: none"> Of the data registered for the IP router table in the TCP/IP settings, any data that exceeds the upper limit (64) for an NX502 Controller is lost. The 1000 Mbps Full Duplex selection is deleted from the selections for the LINK settings. If 1000 Mbps Full Duplex is selected for the NX701 Controller, it changes to Auto.
	Memory Settings	Even when the model is changed to a model with Memory Settings , the data in the Memory Settings is initialized and it is not inherited.	Even when the model is changed from a model with Memory Settings , the data in the Memory Settings is initialized and it is not inherited.
Axis Settings		---	<ul style="list-style-type: none"> An error is displayed if the limit to the number of axes supported by the Controller is exceeded after changing the Controller model. All tasks for devices that are assigned to axes change to the <i>priority-4 primary periodic task</i>. The assigned axis variables for axes that are assigned to <i>MC2 (priority-5 periodic task)</i> in the NX701 Controller change from <code>_MC2_AX[□]</code> to <code>_MC_AX[□]</code>. The Control Function parameter is set to <i>All</i>.
Axes Group Settings		The axes group settings do not change.	<ul style="list-style-type: none"> An error is displayed if the limit to the number of axes groups supported by the Controller is exceeded after changing the Controller model. The assigned variables for axes groups that are assigned to <i>MC2 (priority-5 periodic task)</i> in the NX701 Controller change from <code>_MC2_GRP[□]</code> to <code>_MC_GRP[□]</code>.
Task Settings		If a task period that is unique to the NX502 Controller is set, it changes to the nearest settable NX701 Controller task period that is not smaller than the original task period.	<ul style="list-style-type: none"> The <i>priority-5</i> and <i>priority-16 periodic tasks</i> are deleted. All program assignments to this task are deleted. If a task period that is unique to the NX701 Controller is set, it changes to the nearest settable NX502 Controller task period that is not smaller than the original task period. The results of the change are displayed in the Output Tab Page.

Item	Precautions when changing the Controller model	
	Changing from NX502 to NX701	Changing from NX701 to NX502
DB Connection Settings	When the model is changed to a model with DB connection settings, the DB connection settings do not change. When the model is changed to a model without DB connection settings, the DB connection settings are deleted.	When the model is changed from a model with DB connection settings, the DB connection settings do not change.

A-11-13 Changing between NX502 and NY-series Controllers

Item	Precautions when changing the Controller model		
	Changing from NX502 to NY Series	Changing from NY Series to NX502	
EtherCAT Configuration and Setup, and EtherCAT Slave Terminal Configuration and Setup	<ul style="list-style-type: none"> The EtherCAT configuration and setup that include the EtherCAT Slave Terminal configuration and setup do not change. 	<ul style="list-style-type: none"> An error is displayed if the limit to the number of slaves supported by the Controller is exceeded after changing the Controller model. If a task period that is unique to the NY-series Controller is set, the task period changes when the Controller model is changed, so the value of the PDO communications cycle changes. Refer to <i>Task Settings</i> for information on changes in the task periods. 	
CPU/Expansion Rack Configuration and Setup	The Unit configuration and the setup parameters for all Units are deleted. All I/O ports are deleted and all variable assignments to I/O ports are deleted.	The CPU/Expansion Rack configuration and setup are added in the same condition as when a new project is created.	
Controller Setup	Operation Settings	Among the general setting items, those unique to the NX502 Controller are deleted.	Among the general setting items, those unique to the NY-series Controller are deleted.
	Built-in EtherNet/IP Port Settings	<ul style="list-style-type: none"> The IP Address - Port 1 settings in the TCP/IP settings are used as the IP Address - EtherNet/IP Port settings. The IP Address - Port 2 settings are lost. The LINK Settings - Port 1 settings are used for the LINK Settings. The LINK Settings - Port 2 settings are lost. 	<ul style="list-style-type: none"> The IP Address - EtherNet/IP Port settings in the TCP/IP settings are used as the IP Address - Port 1 settings. The IP Address - Internal Port 1 settings are lost. The LINK Settings are used for the LINK Settings - Port 1 settings. Of the data registered for the IP router table in the TCP/IP settings, any data that exceeds the upper limit (64) for an NX502 Controller is lost. The 1000 Mbps Full Duplex selection is deleted from the selections for the LINK settings. If 1000 Mbps Full Duplex is selected for the NY-series Controller, it changes to Auto.

Item	Precautions when changing the Controller model	
	Changing from NX502 to NY Series	Changing from NY Series to NX502
Axis Settings	---	<ul style="list-style-type: none"> An error is displayed if the limit to the number of axes supported by the Controller is exceeded after changing the Controller model. The Control Function parameter is set to <i>All</i>.
Axes Group Settings	The axes group settings do not change.	An error is displayed if the limit to the number of axes groups supported by the Controller is exceeded after changing the Controller model.
Task Settings	If a task period that is unique to the NX502 Controllers is set, it changes to the nearest settable NY-series Controller task period that is not smaller than the original task period.	<ul style="list-style-type: none"> The <i>priority-16 periodic task</i> is deleted. All program assignments to this task are deleted. If a task period that is unique to the NY-series Controllers is set, it changes to the nearest settable NX502 Controller task period that is not smaller than the original task period. The results of the change are displayed in the Output Tab Page.
EtherNet/IP Connection Settings	The connection settings in the Built-in EtherNet/IP Port Settings - Port 1 settings are used for the Built-in EtherNet/IP Port Settings . The Built-in EtherNet/IP Port Settings - Port 2 settings are lost.	The connection settings in the Built-in EtherNet/IP Port Settings are used for the Built-in EtherNet/IP Port Settings - Port 1 settings.
DB Connection Settings	The DB connection settings are deleted.	---

A-11-14 Changing between NX502 and NX102 Controllers

Item	Precautions when changing the Controller model	
	Changing from NX502 to NX102	Changing from NX102 to NX502
EtherCAT Configuration and Setup, and EtherCAT Slave Terminal Configuration and Setup	<ul style="list-style-type: none"> An error is displayed if the limit to the number of slaves supported by the Controller is exceeded after changing the Controller model. If a task period that is unique to the NX502 Controller is set, the task period changes when the Controller model is changed, so the value of the PDO communications cycle changes. Refer to <i>Task Settings</i> for information on changes in the task periods. 	The EtherCAT configuration and setup that include the EtherCAT Slave Terminal configuration and setup do not change.

Item		Precautions when changing the Controller model	
		Changing from NX502 to NX102	Changing from NX102 to NX502
CPU/Expansion Rack Configuration and Setup		The NX Bus Unit configuration and the setup parameters are inherited. The X Bus Unit configuration and the setup parameters are deleted. An error is displayed if the limit to the number of Units supported by the Controller is exceeded after changing the Controller series.	The Unit configuration and the setup parameters are used.
Controller Setup	Operation Settings	Among the general setting items, those unique to the NX502 Controller are deleted.	Among the general setting items, those unique to the NX102 Controller are deleted.
	Built-in EtherNet/IP Port Settings	<ul style="list-style-type: none"> The IP Address - Port 1 settings in the TCP/IP settings are used as the IP Address settings. The IP Address - Port 2 settings are lost. Of the data registered for the IP router table in the TCP/IP settings, any data that exceeds the upper limit (8) for an NX102 Controller is lost. The LINK Settings - Port 1 settings are used for the LINK Settings. The LINK Settings - Port 2 settings are lost. Among the FINS settings, the FINS/TCP settings are deleted. 	<ul style="list-style-type: none"> The IP Address settings in the TCP/IP settings are used as the IP Address - Port 1 settings. The LINK Settings are used for the LINK Settings - Port 1 settings.
	Memory Settings	The data in the Memory Settings is initialized and it is not inherited.	The data in the Memory Settings is initialized and it is not inherited.
Axis Settings		An error is displayed if the limit to the number of axes supported by the Controller is exceeded after changing the Controller model.	An error is displayed if the limit to the number of axes supported by the Controller is exceeded after changing the Controller model.
Axes Group Settings		An error is displayed if the limit to the number of axes groups supported by the Controller is exceeded after changing the Controller model.	An error is displayed if the limit to the number of axes groups supported by the Controller is exceeded after changing the Controller model.
DB Connection Settings		When the model is changed to a model with DB connection settings, the DB connection settings do not change. When the model is changed to a model without DB connection settings, the DB connection settings are deleted.	When the model is changed from a model with DB connection settings, the DB connection settings do not change.

A-11-15 Changing between NX502 and NX1P2 Controllers

Item		Precautions when changing the Controller model	
		Changing from NX502 to NX1P2	Changing from NX1P2 to NX502
EtherCAT Configuration and Setup, and EtherCAT Slave Terminal Configuration and Setup		<ul style="list-style-type: none"> An error is displayed if the limit to the number of slaves supported by the Controller is exceeded after changing the Controller model. If a task period that is unique to the NX502 Controller is set, the task period changes when the Controller model is changed, so the value of the PDO communications cycle changes. Refer to <i>Task Settings</i> for information on changes in the task periods. 	The EtherCAT configuration and setup that include the EtherCAT Slave Terminal configuration and setup do not change.
CPU/Expansion Rack Configuration and Setup		The NX Bus Unit configuration and the setup parameters are inherited. The X Bus Unit configuration and the setup parameters are deleted. An error is displayed if the limit to the number of Units supported by the Controller is exceeded after changing the Controller series.	The Unit configuration and the setup parameters are used.
Controller Setup	Operation Settings	Among the general setting items, those unique to the NX502 Controller are deleted.	Among the general setting items, those unique to the NX1P2 Controller are deleted.
	Built-in EtherNet/IP Port Settings	<ul style="list-style-type: none"> The IP Address - Port 1 settings in the TCP/IP settings are used as the IP Address settings. The IP Address - Port 2 settings are lost. Of the data registered for the IP router table in the TCP/IP settings, any data that exceeds the upper limit (8) for an NX1P2 Controller is lost. The LINK Settings - Port 1 settings are used for the LINK Settings. The LINK Settings - Port 2 settings are lost. Among the FINS settings, the FINS/TCP settings are deleted. 	<ul style="list-style-type: none"> The IP Address settings in the TCP/IP settings are used as the IP Address - Port 1 settings. The LINK Settings are used for the LINK Settings - Port 1 settings.
	Memory Settings	The data in the Memory Settings is initialized and it is not inherited.	The data in the Memory Settings is initialized and it is not inherited.
Axis Settings		An error is displayed if the limit to the number of axes supported by the Controller is exceeded after changing the Controller model.	An error is displayed if the limit to the number of axes supported by the Controller is exceeded after changing the Controller model.
Axes Group Settings		An error is displayed if the limit to the number of axes groups supported by the Controller is exceeded after changing the Controller model.	An error is displayed if the limit to the number of axes groups supported by the Controller is exceeded after changing the Controller model.
DB Connection Settings		The DB connection settings are deleted.	---

A-12 Report Tools

If a problem occurs in an NJ/NX/NY-series Controller or the Sysmac Studio, you can use the Report Tools to save information in a file to help solve the problem.

Please provide the files that are saved to the OMRON support center when you request support.

A-12-1 Sysmac Controller Log Upload Tool

This tool saves the operation log from an NJ/NX/NY-series Controller or Slave Terminal to two or more ZIP files.

- 1 Select **OMRON - Sysmac Studio - Tools - Sysmac Controller Log Upload Tool** from the Windows Start Menu.

The **Sysmac Controller Log Upload Tool** is displayed.

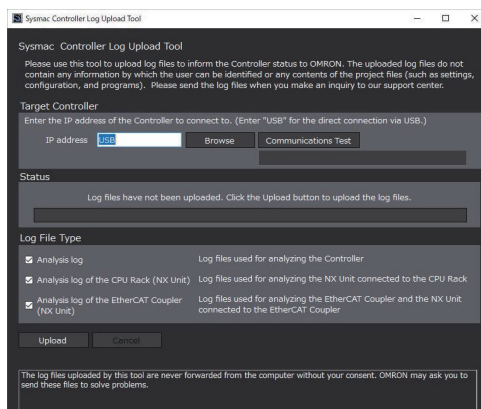

- 2 Enter the IP address of the target Controller in the **IP address** field in the **Target Controller** area. If the target Controller is connected directly with a USB cable, enter **USB** for the **IP address**.

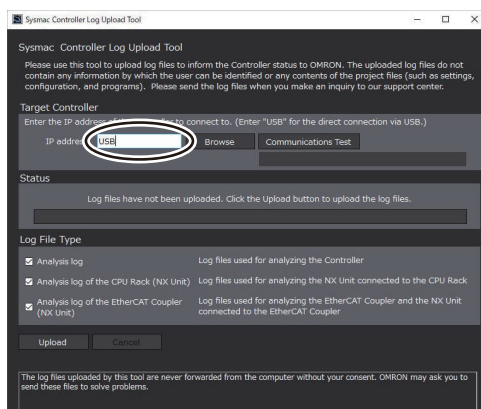

Click the **Communications Test** button to see if you can connect to the Controller.

- 3 Click the **Upload** button.

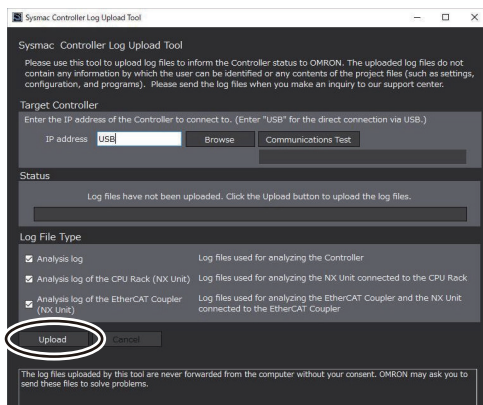

The Controller log is uploaded from the Controller and the directory where the log files were saved is displayed in the **Status** area.

- 4 Click the button labeled with the directory name in the **Status** area.

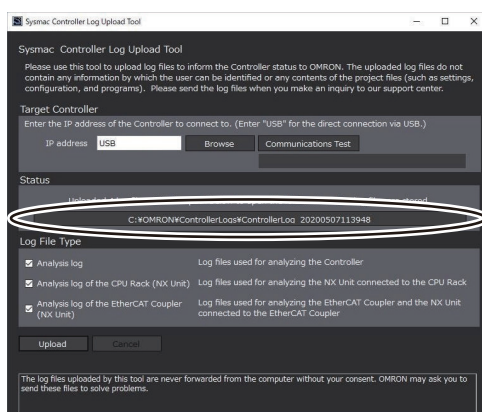

The log files are displayed in Windows Explorer.
Send the log files to the support center.



Precautions for Correct Use

If **Packet Filter** in Built-in EtherNet/IP Port Settings of the Controller is set to **Use**, you might not be able to carry out operations such as Browse and Upload. If such operations are unavailable, enter the IP address of the Controller in **Target Controller – IP address**, and execute **Upload**. If you still cannot upload it, check the Packet Filter settings. Refer to the *NJ/NX-series CPU Unit Built-in EtherNet/IP Port User's Manual (Cat. No. W506)* for details on the Packet Filter settings.



Additional Information

- To specify the target Controller, you can click the **Browse** button to display the **Network Browser** Dialog Box and then select the target Controller in it.
- The log files that are uploaded by this tool do not contain any information that can be used to identify you and they do not contain your project files (e.g., settings, configurations, and programs).
- The log files uploaded by this tool will not be sent from your computer to any external party without your specific approval.



Version Information

A CPU Unit with unit version 1.10 or later is required to use this tool.

A-12-2 Sysmac Studio Error Report Generating Tool

This tool saves information on the computer and project when problems occur with the Sysmac Studio. The information is saved in a ZIP file.

- 1 Select **OMRON - Sysmac Studio - Tools - Sysmac Studio Error Report Generating Tool** from the Windows Start Menu.

The **Sysmac Studio Error Report Generating Tool** is displayed.

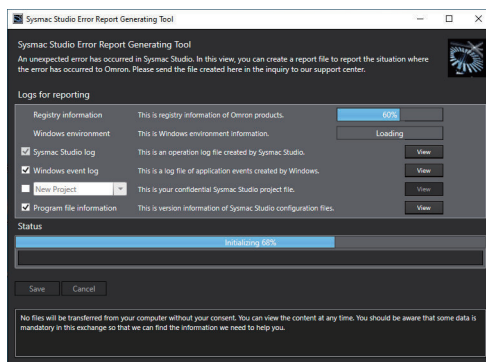

A list of the information that is saved is displayed in the **Logs for reporting** area.

Select the check boxes for the files to save according to instructions from your OMRON support center.

You can click any of the **View** buttons to check the information files that will be saved.

- 2 Click the **Save** button.

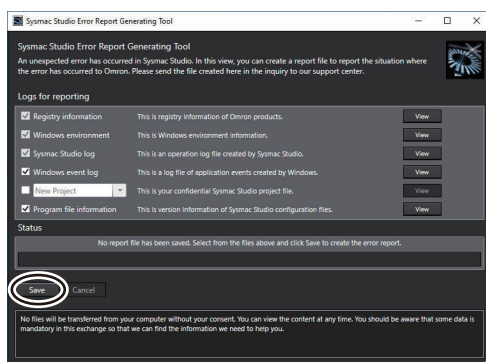

The error reports are saved and the name of the file that was created is displayed in the **Status** area.

- 3 Click the button labeled with the created file name in the **Status** area.

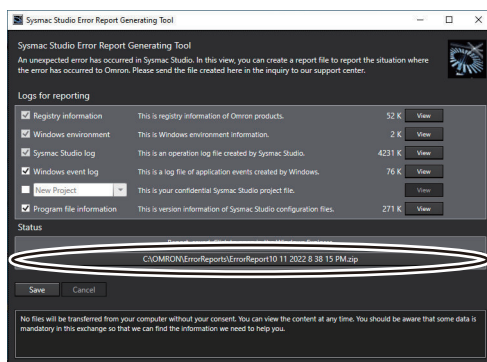

The created file is displayed in Windows Explorer.
Send the created file to the support center.



Precautions for Correct Use

If you select the check box for the *project name* in the **Logs for reporting** area, this tool will create a file that contains your project file (e.g., settings, configurations, and programs). Confirm that there are no problems in including your project information before you select this check box.

If you do not select this check box, the files created by this tool do not contain any information that can be used to identify you and they do not contain your project files.



Additional Information

The files created by this tool will not be sent from your computer to any external party without your specific approval.

A-12-3 Sysmac Coupler Log Upload Tool

This tool saves the operation log from a Slave Terminal to a ZIP file.

- 1 Select **OMRON - Sysmac Studio - Tools - Sysmac Coupler Log Upload Tool** from the Windows Start Menu.

The **Sysmac Coupler Log Upload Tool** is displayed.

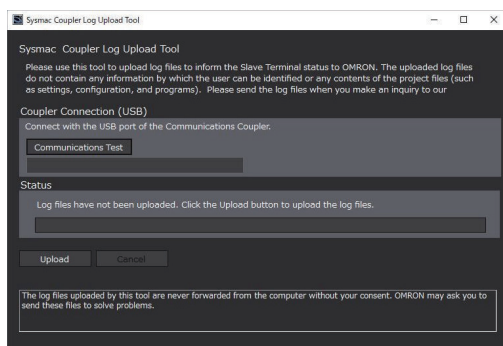

- 2 Connect to the Communications Coupler Unit with a USB cable.
Click the **Communications Test** button to see if you can communicate with the Unit.
- 3 Click the **Upload** button.

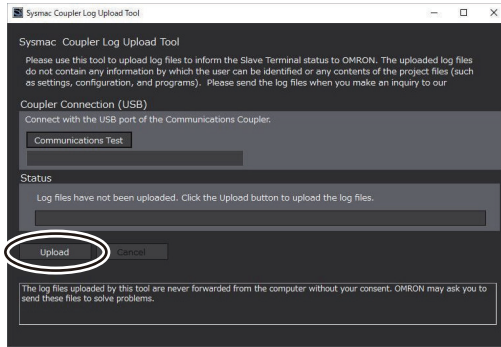

The Slave Terminal log is uploaded from the Slave Terminal and the directory where the log files were saved is displayed in the **Status** area.

- 4 Click the button labeled with the directory name in the **Status** area.

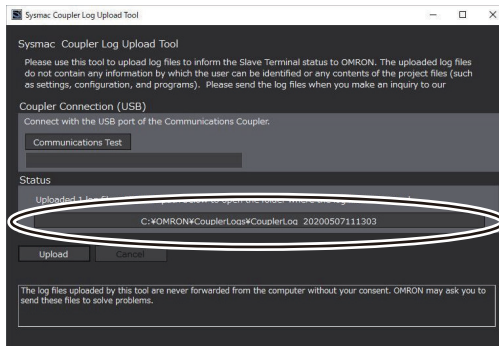

The log files are displayed in Windows Explorer.
Send the log files to the support center.



Additional Information

- The log files that are uploaded by this tool do not contain any information that can be used to identify you and they do not contain your project files (e.g., settings, configurations, and programs).
- The log files uploaded by this tool will not be sent from your computer to any external party without your specific approval.

A-13 Downloading Manuals

You can browse the OMRON manual download website from the Sysmac Studio and download the latest manuals for the Sysmac Studio.



Precautions for Correct Use

- An Internet connection is required to use this function.
- Microsoft Edge based on Chromium is required to use this function. It is also required to enable JavaScript in the Microsoft Edge settings.
- You must start this function from the Sysmac Studio, or the Windows Start Menu.

A-13-1 Displaying the Manual Download Site

- 1 Select **Manual Download** from the **Help** Menu of the Sysmac Studio. Or select **All Programs - OMRON - Sysmac Manual Download** from the Windows Start Menu. Microsoft Edge starts and displays the **Sysmac Family Manual Download** page.

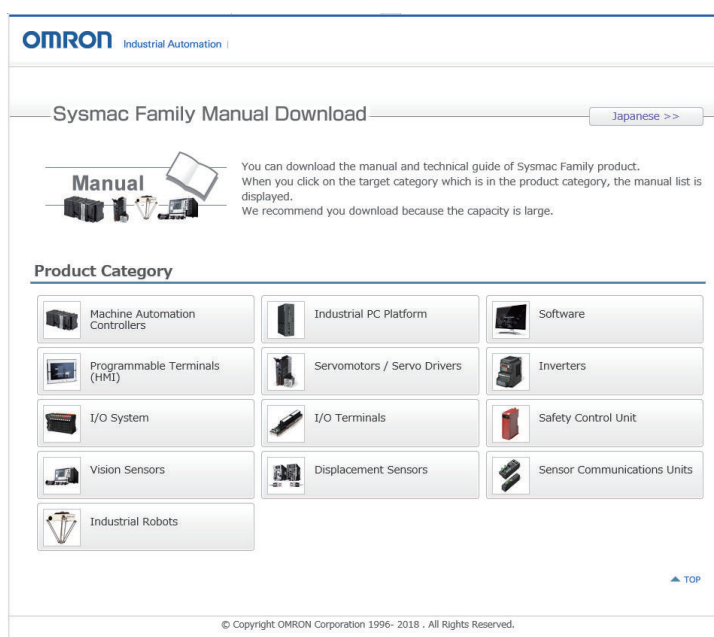

Select the target product from **Product Category** and download manuals.



Index



Index

Numerics

.NET Framework.....	1-10, 2-3
2D Path Display.....	7-69
3D equipment models.....	7-74, 7-107
3D Motion Monitor Display Mode.....	7-68
3G3AX-MX2-ECT.....	5-37

A

addresses.....	1-2
administrator.....	2-2
administrator rights.....	2-2
AT Specification attribute.....	4-42
attributes.....	4-36
authentication of user program execution IDs.....	8-34
Auto Connection Project.....	6-11
Automation Software.....	1-6
Axes Group Basic Settings.....	5-98
Axes Group Operation Settings.....	5-99
Axes Group Variables.....	4-3, 4-30
Axis Basic Settings.....	5-81
Axis Setting Table.....	5-84
Axis Status Monitor.....	7-51
Axis Variables.....	4-3, 4-27

B

backing up variables and memory.....	8-76
backup.....	8-77
backup parameter settings.....	5-12
Base Type attribute.....	4-77
Basic Settings View.....	5-65
bookmarks.....	4-111, 4-157
breakpoints.....	7-99
Build Tab Page.....	3-43
building.....	4-178
Built-in EtherNet/IP Port Settings.....	5-71

C

calibrate for execution time estimates.....	7-93
cam data.....	5-105
cam data variables.....	4-3, 4-32
changing present values.....	1-3, 7-24, 7-27
changing programming.....	1-3
checking I/O assignments.....	7-154
checking I/O wiring.....	7-153
CJ1W-DRM21.....	10-2
CJ1W-EIP21.....	10-2
CJ1W-EIP21S.....	10-2
CJ1W-SCU22.....	10-3
CJ1W-SCU32.....	10-3
CJ1W-SCU42.....	10-3
clearing memory.....	8-58
clock information.....	8-8

comment.....	4-156
Comment attribute.....	4-45, 4-78
communications.....	3-77
Communications Middleware.....	1-6, 2-3
Communications Setup.....	6-5
connection methods.....	6-3
Constant attribute.....	4-44
constants.....	4-155
continuous step.....	7-101
Controller.....	3-55, 3-56, 6-2
Controller backup.....	8-71
Controller Configurations and Setup.....	3-4, 3-6
Controller errors.....	1-3, 8-120, 8-121
Controller event log.....	8-120, 8-125
Controller models.....	1-7
Controller Setup.....	5-65
Controller status.....	1-3, 7-46
Controller Status Pane.....	3-41
CPU Rack and Expansion Rack Configuration of NJ-series Controllers.....	7-148
creating a project.....	3-3, 3-6
creating Axes Group Variables.....	4-30
creating Axis Variables.....	4-27
creating cam data variables.....	4-32
creating data types.....	4-69
creating function block instance variables.....	4-35
creating global variables.....	4-4
creating local variables.....	4-22
Cross Reference Tab Page.....	3-42
cross references.....	7-36
CX-ConfiguratorFDT.....	2-3
CX-Designer.....	1-6, 2-3, 10-2, 10-3
CX-Integrator.....	1-6, 2-3, 10-2
CX-One.....	2-2, 2-3
CX-Protocol.....	1-6, 2-3, 10-2, 10-3
CX-Server.....	1-6, 2-3

D

data protection.....	8-39
data tracing.....	7-53, 7-106
Data Type attribute.....	4-38
data type attributes.....	4-77
data types.....	3-42
debug programs.....	7-89
debugging.....	3-73
designing tasks.....	3-4, 3-7
designing the user program.....	3-3, 3-7
device variables.....	4-3, 4-11, 7-27
diagnostic and statistical information.....	8-94
Differential Monitor.....	7-21
direct connection via Ethernet.....	6-3
direct connection via USB.....	6-3
direct Ethernet connection.....	2-10
Direct Ethernet Utility.....	A-11

- DirectX..... 2-3
 disconnecting a slave from and reconnecting a slave to the network..... 8-91
 download..... 7-127
 DVD media..... 1-12
- ## E
-
- Edge attribute..... 4-45
 Edit Menu..... 3-52
 Edit Pane..... 3-36
 Edit Properties..... 3-15
 Editing ST..... 4-152
 Element Comment..... 4-135, 8-170
 entering variables..... 4-102
 Enum Value attribute..... 4-78
 enumerations..... 4-73
 ESI files..... 5-17
 estimating task execution times..... 7-92
 EtherCAT..... 5-4, 7-140
 Ethernet connection via a hub..... 6-3
 Ethernet interface card..... 6-9, A-11
 Event Setting Table..... 8-131
 exporting..... 3-19, 5-15, 5-60, 7-65
- ## F
-
- File Menu..... 3-52
 Filter Pane..... 3-35
 FINS Settings..... 5-68
 forced refreshing..... 6-9, 7-24, 7-30
 FTP Settings..... 5-71
 function block instance variables..... 4-3, 4-35
 function blocks.....
 1-2, 1-3, 3-42, 4-60, 4-117, 4-152, 4-162, 4-163
 functions..... 1-2, 1-3, 3-42, 4-62, 4-152, 4-162, 4-163
- ## G
-
- G5 Series..... 5-37
 global variables..... 4-3, 4-4
- ## H
-
- Help Menu..... 3-58
 Homing Settings..... 5-82
- ## I
-
- I/O Map..... 7-4, 7-19, 7-123
 I/O ports..... 3-42
 I/O wiring check..... A-62
 IEC 61131-3..... 1-3
 IEC 61131-3 programming..... 3-3
 importing..... 3-21, 5-16, 5-60, 7-65
 In/Out attribute..... 4-44
 indenting..... 4-157
 Initial Value attribute..... 4-40
 inline ST..... 4-105
 Insert Menu..... 3-53, 3-54
 inserting a program input in an AND structure..... 4-91
 inserting a program input in an OR structure..... 4-93
 inserting program outputs in an OR structure..... 4-98
 inserting program outputs in series in an AND structure..... 4-96
 installation..... 2-2, 5-17, A-3
 Instruction Reference..... A-23
- ## J
-
- jump labels..... 4-138
 jumps..... 4-139
- ## K
-
- Keyboard Mapping Reference..... A-24
- ## L
-
- ladder diagram and structured text..... 1-3
 Ladder Editor..... 7-4
 last modified..... 3-19
 libraries..... 9-8
 creating a Library..... 9-8
 using a Library..... 9-12
 license certificate..... 1-12
 license number..... 1-12, 2-5
 licenses..... 1-4, 1-12, 2-5
 Limit Settings..... 5-82
 Link Settings..... 5-71
 local variables..... 4-3, 4-22
- ## M
-
- maintenance..... 3-77
 Map Settings..... 5-10
 members..... 4-74
 memory addresses..... 1-2
 monitoring information..... 3-76
 Motion Control Setup..... 5-80
 Multiview Explorer..... 3-33
 MX2 Series..... 5-37
- ## N
-
- NA-series..... 3-90
 Name attribute..... 4-38, 4-77
 namespaces..... 4-79
 .NET Framework..... 1-10, 2-3
 network card..... 2-10
 Network Configurator..... 1-6, 2-3, 10-2
 Network Publish attribute..... 4-44
 New Project Button..... 3-11
 NS Series..... 10-3
 NTP Settings..... 5-71
- ## O
-
- offline comparison..... 4-180
 offline program debugging..... 3-4, 3-7
 online connection..... 6-2

online help.....	3-80, A-23
online program debugging.....	3-5, 3-8
Open Project Button.....	3-11, 3-18
operating modes.....	7-45
operation authority verification.....	8-9, 8-11
Operation Settings.....	5-65, 5-82
Other Operation Settings.....	5-82
Output Tab Page.....	3-42

P

packet monitoring.....	8-93
parameters.....	4-124, 4-127
PDO.....	5-10
PDO Map Settings.....	5-10
Position Count Settings.....	5-82
POUs.....	4-152
POUs (program organization units).....	1-2, 4-57
POUs(function blocks).....	4-85, 4-152
POUs(functions).....	4-85, 4-152
POUs(programs).....	4-85, 4-152
preparations for online debugging.....	3-5, 3-8
printing.....	7-67, 8-52
program assignments.....	5-127
program checks.....	4-175
programming.....	3-68
programming ladder diagram.....	4-85
programming structured text.....	4-152
programs.....	1-2, 1-3
project management.....	3-72
Project Menu.....	3-54
project name.....	3-19

R

R88D-KN□-ECT.....	5-37
rebuilding.....	4-178
registering function blocks.....	4-60
registering functions.....	4-62
registering POUs.....	4-57
registering programs.....	4-57
registering slaves.....	5-4, 5-6
releasing access rights.....	8-64
remote connection via USB.....	6-3
Reset.....	7-24
restoring data.....	8-79
Retain attribute.....	4-43
reusing device and program assets.....	9-4
rung errors.....	4-112

S

Save As.....	3-17
SD Memory Card.....	8-4
SD Memory Card backup.....	8-75
Search and Replace Pane.....	3-41
Search and Replace Results Tab Page.....	3-43
searching and replacing.....	4-168
sections.....	4-86
secure communications setting.....	8-9

secure socket settings.....	8-9
security measures.....	3-78
Security Settings.....	8-9
Serial ID.....	6-8
Servo Drive Settings.....	5-82
Set.....	7-24
setting axes groups.....	5-97
setting EtherCAT Drives.....	5-37
setting master parameters.....	5-8
setting parameter settings.....	5-11
setting parameters.....	3-62, 5-39
setting slave parameters.....	5-9
shortcut keys.....	A-25
SIM_SetActPos.....	A-50
SIM_SetActTrq.....	A-54
SIM_SetActVel.....	A-52
SIM_SetDrvAlm.....	A-46
SIM_SetDrvWarn.....	A-47
SIM_SetVelocity.....	A-49
SIM_SigEmergStop.....	A-43
SIM_SigExtLatch.....	A-44
SIM_SigNegLmt.....	A-40
SIM_SigPosLmt.....	A-38
Simulate Drive Alarm instruction.....	A-46
Simulate Drive Warning instruction.....	A-47
Simulate External Latch Input Signal instruction.....	A-44
Simulate Home Proximity Signal instruction.....	A-42
Simulate Immediate Stop Input Signal instruction.....	A-43
Simulate Negative Limit Input Signal instruction.....	A-39
Simulate Positive Limit Input Signal instruction.....	A-29, A-38
simulation.....	3-75, 7-86
simulation instructions.....	A-38
Simulation Menu.....	3-56
Simulation Pane.....	3-42
simulation programs.....	7-88
simulation speed.....	7-98
simulations.....	1-3
Simulator.....	6-2, A-15
Simulator connection.....	6-2
slaves.....	8-91
SNMP Settings.....	5-72
SNMP Trap Settings.....	5-72
special instructions.....	7-91
ST Editor.....	7-4, 7-6
step execution.....	7-100
structure data types.....	4-69
synchronizing.....	7-127
system requirements.....	1-9
system-defined variables.....	4-36, 7-27

T

Task Execution Status Monitor.....	7-50
Task Execution Time Monitor.....	7-50
Task I/O Settings.....	5-126
Task Settings.....	5-125
TCP/IP Settings.....	5-71
testing operation.....	3-5, 3-8, 7-149
Toolbox.....	3-41

Tools Menu.....	3-57
troubleshooting.....	1-3, 8-120

U

unions.....	4-71
Unit Conversion Settings.....	5-81
unit production information.....	8-66
upload.....	7-127
USB device driver.....	2-7, 2-10
USB driver.....	A-3
USB port.....	A-3
User Memory Usage Monitor.....	8-49
user program execution ID.....	8-9
user-defined errors.....	1-3, 8-120, 8-129
user-defined event log.....	8-120, 8-130

V

Variable Manager.....	4-48
variable registration.....	4-3
variables.....	3-42, 4-3, 4-36, 4-124, 4-127, 7-27, 7-122, 7-124
version of the CX-One.....	2-2
View Menu.....	3-53

W

Watch Tab Page.....	3-43, 7-4, 7-8
Windows 10 (32-bit or 64-bit edition).....	1-10, 2-2
Windows 11 (64-bit edition).....	1-10, 2-2
Windows 7 (32-bit or 64-bit edition).....	1-10, 2-2
Windows 8.1 (32-bit or 64-bit edition).....	1-10, 2-2
write protection of the CPU Unit.....	8-9, 8-37

OMRON Corporation Industrial Automation Company

Kyoto, JAPAN

Contact : www.ia.omron.com

Regional Headquarters

OMRON EUROPE B.V.

Wegalaan 67-69, 2132 JD Hoofddorp
The Netherlands
Tel: (31) 2356-81-300 Fax: (31) 2356-81-388

OMRON ELECTRONICS LLC

2895 Greenspoint Parkway, Suite 200
Hoffman Estates, IL 60169 U.S.A.
Tel: (1) 847-843-7900 Fax: (1) 847-843-7787

OMRON ASIA PACIFIC PTE. LTD.

438B Alexandra Road, #08-01/02 Alexandra
Technopark, Singapore 119968
Tel: (65) 6835-3011 Fax: (65) 6835-3011

OMRON (CHINA) CO., LTD.

Room 2211, Bank of China Tower,
200 Yin Cheng Zhong Road,
PuDong New Area, Shanghai, 200120, China
Tel: (86) 21-6023-0333 Fax: (86) 21-5037-2388

Authorized Distributor:

©OMRON Corporation 2011-2026 All Rights Reserved.
In the interest of product improvement,
specifications are subject to change without notice.

Cat. No. W504-E1-57 0126