

Machine Automation Controller NJ/NX/NY-series

Sysmac Library User's Manual for Safety System Monitor Library

NX701-□□□□

NX102-□□□□

NJ501-□□□□

NJ301-□□□□

NJ101-□□□□

NY532-1□□□

NY512-1□□□

NY53□-□□□□

NOTE

All rights reserved. No part of this publication may be reproduced, stored in a retrieval system, or transmitted, in any form, or by any means, mechanical, electronic, photocopying, recording, or otherwise, without the prior written permission of OMRON.

No patent liability is assumed with respect to the use of the information contained herein. Moreover, because OMRON is constantly striving to improve its high-quality products, the information contained in this manual is subject to change without notice. Every precaution has been taken in the preparation of this manual. Nevertheless, OMRON assumes no responsibility for errors or omissions. Neither is any liability assumed for damages resulting from the use of the information contained in this publication.

Trademarks

- Sysmac and SYSMAC are trademarks or registered trademarks of OMRON Corporation in Japan and other countries for OMRON factory automation products.
- Microsoft, Windows, Windows Vista, Excel, and Visual Basic are either registered trademarks or trademarks of Microsoft Corporation in the United States and other countries.
- EtherCAT® is registered trademark and patented technology, licensed by Beckhoff Automation GmbH, Germany.
- ODVA, CIP, CompoNet, DeviceNet, and EtherNet/IP are trademarks of ODVA.
- The SD and SDHC logos are trademarks of SD-3C, LLC. 

Other company names and product names in this document are the trademarks or registered trademarks of their respective companies.

Copyrights

Microsoft product screen shots reprinted with permission from Microsoft Corporation.

Introduction

Thank you for purchasing an NJ/NX-series CPU Unit.

This manual contains information that is necessary to use the function blocks in the Safety System Monitor Library. ("Function block" is sometimes abbreviated as "FB".) Please read this manual and make sure you understand the functionality and performance of the NJ/NX-series CPU Unit before you attempt to use it in a control system.

This manual provides function block specifications. It does not describe application restrictions or combination restrictions for Controllers, Units, and components.

Refer to the user's manuals for all of the products in the application before you use any of the products.

Keep this manual in a safe place where it will be available for reference during operation.

Features of the Library

The Safety System Monitor Library is used to monitor safety system information.

You can use the Safety System Monitor Library to correctly manage information on the safety system during operation.

Intended Audience

This manual is intended for the following personnel, who must also have knowledge of electrical systems (an electrical engineer or the equivalent).

- Personnel in charge of introducing FA systems.
- Personnel in charge of designing FA systems.
- Personnel in charge of installing and maintaining FA systems.
- Personnel in charge of managing FA systems and facilities.

For programming, this manual is intended for personnel who understand the programming language specifications in international standard IEC 61131-3 or Japanese standard JIS B 3503.

Applicable Products

For the model numbers and versions of an NJ/NX-series CPU Unit, NY-series Industrial PC, and the Sysmac Studio that this library supports, refer to Sysmac Library Version Information in the *SYS-MAC-XR□□□ Sysmac Library Catalog* (Cat. No. P102). This catalog can be downloaded from the OMRON website (<http://www.ia.omron.com/products/family/3459/download/catalog.html>).

Manual Structure

Special Information

Special information in this manual is classified as follows:



Precautions for Safe Use

Precautions on what to do and what not to do to ensure safe usage of the product.



Precautions for Correct Use

Precautions on what to do and what not to do to ensure proper operation and performance.



Additional Information

Additional information to read as required.

This information is provided to increase understanding or make operation easier.



Version Information

Information on differences in specifications and functionality for CPU Units with different unit versions and for different versions of the Sysmac Studio are given.

Note References are provided to more detailed or related information.

CONTENTS

Introduction	1
Features of the Library.....	1
Intended Audience.....	1
Applicable Products.....	1
Manual Structure	2
Special Information.....	2
CONTENTS.....	4
Terms and Conditions Agreement.....	6
Warranty, Limitations of Liability	6
Application Considerations	7
Disclaimers	7
Safety Precautions	8
Definition of Precautionary Information.....	8
Symbols.....	8
Cautions.....	9
Precautions for Correct Use.....	10
Related Manuals	11
Revision History	13
Procedure to Use Sysmac Libraries	15
Procedure to Use Sysmac Libraries Installed Using the Installer.....	16
Procedure to Use Sysmac Libraries Uploaded from a CPU Unit.....	20
Common Specifications of Function Blocks.....	23
Common Variables	24
Precautions.....	30
Individual Specifications of Function Blocks.....	31
GetSafetySignature	32
Appendix	39
Referring to Library Information.....	40
Referring to Function Block and Function Source Codes.....	43

Terms and Conditions Agreement

Warranty, Limitations of Liability

Warranties

● Exclusive Warranty

Omron's exclusive warranty is that the Products will be free from defects in materials and workmanship for a period of twelve months from the date of sale by Omron (or such other period expressed in writing by Omron). Omron disclaims all other warranties, express or implied.

● Limitations

OMRON MAKES NO WARRANTY OR REPRESENTATION, EXPRESS OR IMPLIED, ABOUT NON-INFRINGEMENT, MERCHANTABILITY OR FITNESS FOR A PARTICULAR PURPOSE OF THE PRODUCTS. BUYER ACKNOWLEDGES THAT IT ALONE HAS DETERMINED THAT THE PRODUCTS WILL SUITABLY MEET THE REQUIREMENTS OF THEIR INTENDED USE.

Omron further disclaims all warranties and responsibility of any type for claims or expenses based on infringement by the Products or otherwise of any intellectual property right.

● Buyer Remedy

Omron's sole obligation hereunder shall be, at Omron's election, to (i) replace (in the form originally shipped with Buyer responsible for labor charges for removal or replacement thereof) the non-complying Product, (ii) repair the non-complying Product, or (iii) repay or credit Buyer an amount equal to the purchase price of the non-complying Product; provided that in no event shall Omron be responsible for warranty, repair, indemnity or any other claims or expenses regarding the Products unless Omron's analysis confirms that the Products were properly handled, stored, installed and maintained and not subject to contamination, abuse, misuse or inappropriate modification. Return of any Products by Buyer must be approved in writing by Omron before shipment. Omron Companies shall not be liable for the suitability or unsuitability or the results from the use of Products in combination with any electrical or electronic components, circuits, system assemblies or any other materials or substances or environments. Any advice, recommendations or information given orally or in writing, are not to be construed as an amendment or addition to the above warranty.

See <http://www.omron.com/global/> or contact your Omron representative for published information.

Limitation on Liability; Etc

OMRON COMPANIES SHALL NOT BE LIABLE FOR SPECIAL, INDIRECT, INCIDENTAL, OR CONSEQUENTIAL DAMAGES, LOSS OF PROFITS OR PRODUCTION OR COMMERCIAL LOSS IN ANY WAY CONNECTED WITH THE PRODUCTS, WHETHER SUCH CLAIM IS BASED IN CONTRACT, WARRANTY, NEGLIGENCE OR STRICT LIABILITY.

Further, in no event shall liability of Omron Companies exceed the individual price of the Product on which liability is asserted.

Application Considerations

Suitability of Use

Omron Companies shall not be responsible for conformity with any standards, codes or regulations which apply to the combination of the Product in the Buyer's application or use of the Product. At Buyer's request, Omron will provide applicable third party certification documents identifying ratings and limitations of use which apply to the Product. This information by itself is not sufficient for a complete determination of the suitability of the Product in combination with the end product, machine, system, or other application or use. Buyer shall be solely responsible for determining appropriateness of the particular Product with respect to Buyer's application, product or system. Buyer shall take application responsibility in all cases.

NEVER USE THE PRODUCT FOR AN APPLICATION INVOLVING SERIOUS RISK TO LIFE OR PROPERTY OR IN LARGE QUANTITIES WITHOUT ENSURING THAT THE SYSTEM AS A WHOLE HAS BEEN DESIGNED TO ADDRESS THE RISKS, AND THAT THE OMRON PRODUCT(S) IS PROPERLY RATED AND INSTALLED FOR THE INTENDED USE WITHIN THE OVERALL EQUIPMENT OR SYSTEM.

Programmable Products

Omron Companies shall not be responsible for the user's programming of a programmable Product, or any consequence thereof.

Disclaimers

Performance Data

Data presented in Omron Company websites, catalogs and other materials is provided as a guide for the user in determining suitability and does not constitute a warranty. It may represent the result of Omron's test conditions, and the user must correlate it to actual application requirements. Actual performance is subject to the Omron's Warranty and Limitations of Liability.

Change in Specifications

Product specifications and accessories may be changed at any time based on improvements and other reasons. It is our practice to change part numbers when published ratings or features are changed, or when significant construction changes are made. However, some specifications of the Product may be changed without any notice. When in doubt, special part numbers may be assigned to fix or establish key specifications for your application. Please consult with your Omron's representative at any time to confirm actual specifications of purchased Product.

Errors and Omissions

Information presented by Omron Companies has been checked and is believed to be accurate; however, no responsibility is assumed for clerical, typographical or proofreading errors or omissions.



Safety Precautions

Definition of Precautionary Information





The following notation is used in this user’s manual to provide precautions required to ensure safe usage of an NJ/NX-series Controller.

The safety precautions that are provided are extremely important to safety. Always read and heed the information provided in all safety precautions.

The following notation is used.

 WARNING	Indicates a potentially hazardous situation which, if not avoided, could result in death or serious injury. Additionally, there may be severe property damage.
 Caution	Indicates a potentially hazardous situation which, if not avoided, may result in minor or moderate injury, or property damage.

Symbols

	The circle and slash symbol indicates operations that you must not do. The specific operation is shown in the circle and explained in text. This example indicates prohibiting disassembly.
	The triangle symbol indicates precautions (including warnings). The specific operation is shown in the triangle and explained in text. This example indicates a precaution for electric shock.
	The triangle symbol indicates precautions (including warnings). The specific operation is shown in the triangle and explained in text. This example indicates a general precaution.
	The filled circle symbol indicates operations that you must do. The specific operation is shown in the circle and explained in text. This example shows a general precaution for something that you must do.

Cautions

Caution

Read all related manuals carefully before you use this library.



Emergency stop circuits, interlock circuits, limit circuits, and similar safety measures must be provided in external control circuits.



Check the user program, data, and parameter settings for proper execution before you use them for actual operation.



The Sysmac Library and manuals are assumed to be used by personnel that is given in Intended Audience in this manual. Otherwise, do not use them.



The sample programming shows only the portion of a program that uses the function or function block from the library.



When using sample programming in actual devices, also program safety circuits, device interlocks, I/O with other devices, and other control procedures.



Precautions for Correct Use

Using the Library

- When you use the library, functions or function blocks that are not described in the library manual may be displayed on the Sysmac Studio. Do not use functions or function blocks that are not described in the manual.
- Do not change the file names and the contents of any object list.
- Do not turn OFF the power supply to the Controller or EtherCAT slave or stop EtherCAT communications until the processing for this function block ends normally or ends in an error.

Using Sample Programming

- Create a user program that will produce the intended device operation.
- Check the user program for proper execution before you use it for actual operation.

Related Manuals

The following are the manuals related to this manual. Use these manuals for reference.

Manual name	Cat. No.	Model numbers	Application	Description
NX-series CPU Unit Hardware User's Manual	W535	NX701-□□□□	Learning the basic specifications of the NX-series CPU Units, including introductory information, designing, installation, and maintenance. Mainly hardware information is provided.	<p>An introduction to the entire NX-series system is provided along with the following information on the CPU Unit.</p> <ul style="list-style-type: none"> • Features and system configuration • Introduction • Part names and functions • General specifications • Installation and wiring • Maintenance and inspection <p>Use this manual together with the <i>NJ/NX-series CPU Unit Software User's Manual</i> (Cat. No. W501).</p>
NX-series NX102 CPU Unit Hardware User's Manual	W593	NX102-□□□□	Learning the basic specifications of the NX102 CPU Units, including introductory information, designing, installation, and maintenance. Mainly hardware information is provided.	<p>An introduction to the entire NX102 system is provided along with the following information on the CPU Unit.</p> <ul style="list-style-type: none"> • Features and system configuration • Introduction • Part names and functions • General specifications • Installation and wiring • Maintenance and Inspection
NJ-series CPU Unit Hardware User's Manual	W500	NJ501-□□□□ NJ301-□□□□ NJ101-□□□□	Learning the basic specifications of the NJ-series CPU Units, including introductory information, designing, installation, and maintenance. Mainly hardware information is provided.	<p>An introduction to the entire NJ-series system is provided along with the following information on the CPU Unit.</p> <ul style="list-style-type: none"> • Features and system configuration • Introduction • Part names and functions • General specifications • Installation and wiring • Maintenance and inspection <p>Use this manual together with the <i>NJ/NX-series CPU Unit Software User's Manual</i> (Cat. No. W501).</p>
NY-series IPC Machine Controller Industrial Panel PC Hardware User's Manual	W557	NY532-□□□□	Learning the basic specifications of the NY-series Industrial Panel PCs, including introductory information, designing, installation, and maintenance. Mainly hardware information is provided.	<p>An introduction to the entire NY-series system is provided along with the following information on the Industrial Panel PC.</p> <ul style="list-style-type: none"> • Features and system configuration • Introduction • Part names and functions • General specifications • Installation and wiring • Maintenance and inspection
NY-series IPC Machine Controller Industrial Box PC Hardware User's Manual	W556	NY512-□□□□	Learning the basic specifications of the NY-series Industrial Box PCs, including introductory information, designing, installation, and maintenance. Mainly hardware information is provided.	<p>An introduction to the entire NY-series system is provided along with the following information on the Industrial Box PC.</p> <ul style="list-style-type: none"> • Features and system configuration • Introduction • Part names and functions • General specifications • Installation and wiring • Maintenance and inspection

Manual name	Cat. No.	Model numbers	Application	Description
NJ/NX-series CPU Unit Software User's Manual	W501	NX701-□□□□ NX102-□□□□ NX1P2-□□□□ NJ501-□□□□ NJ301-□□□□ NJ101-□□□□	Learning how to program and set up an NJ/NX-series CPU Unit. Mainly software information is provided.	The following information is provided on a Controller built with an NJ/NX-series CPU Unit. <ul style="list-style-type: none"> • CPU Unit operation • CPU Unit features • Initial settings • Programming based on IEC 61131-3 language specifications Use this manual together with the <i>NX-series CPU Unit Hardware User's Manual</i> (Cat. No. W535) or <i>NJ-series CPU Unit Hardware User's Manual</i> (Cat. No. W500).
NY-series IPC Machine Controller Industrial Panel PC / Industrial Box PC Software User's Manual	W558	NY532-□□□□ NY512-□□□□	Learning how to program and set up the Controller functions of an NY-series Industrial PC.	The following information is provided on the NY-series Controller functions. <ul style="list-style-type: none"> • Controller operation • Controller features • Controller settings • Programming based on IEC 61131-3 language specifications
NJ/NX-series Instructions Reference Manual	W502	NX701-□□□□ NX102-□□□□ NX1P2-□□□□ NJ501-□□□□ NJ301-□□□□ NJ101-□□□□	Learning detailed specifications on the basic instructions of an NJ/NX-series CPU Unit.	The instructions in the instruction set (IEC 61131-3 specifications) are described. When programming, use this manual together with the <i>NX-series CPU Unit Hardware User's Manual</i> (Cat. No. W535) or <i>NJ-series CPU Unit Hardware User's Manual</i> (Cat. No. W500) and with the <i>NJ/NX-series CPU Unit Software User's Manual</i> (Cat. No. W501).
NY-series Instructions Reference Manual	W560	NY532-□□□□ NY512-□□□□	Learning detailed specifications on the basic instructions of an NY-series Industrial PC.	The instructions in the instruction set (IEC 61131-3 specifications) are described.
NX-series EtherCAT® Coupler Unit User's Manual	W519	NX-ECC20□	Learning how to use an NX-series EtherCAT Coupler Unit and EtherCAT Slave Terminals.	The following items are described: the overall system and configuration methods of an EtherCAT Slave Terminal (which consists of an NX-series EtherCAT Coupler Unit and NX Units), and information on hardware, setup, and functions to set up, control, and monitor NX Units through EtherCAT.
NX-series Safety Control Unit User's Manual	Z930	NX-SL□□□□ NX-SI□□□□ NX-SO□□□□	Learning how to use NX-series Safety Control Units	Describes the hardware, setup methods, and functions of the NX-series Safety Control Units.
NJ/NY-series NC Integrated Controller User's Manual	O030	NJ501-5300 NY532-5400	Performing numerical control with NJ/NY-series Controllers.	Describes the functionality to perform the numerical control. Use this manual together with the <i>NJ/NY-series G code Instructions Reference Manual</i> (Cat. No. O031) when programming.
G code Instructions Reference Manual	O031	NJ501-5300 NY532-5400	Learning about the specifications of the G code/M code instructions.	The G code/M code instructions are described. Use this manual together with the <i>NJ/NY-series NC Integrated Controller User's Manual</i> (Cat. No. O030) when programming.
Sysmac Studio Version 1 Operation Manual	W504	SYSMAC -SE2□□□	Learning about the operating procedures and functions of the Sysmac Studio.	Describes the operating procedures of the Sysmac Studio.
CNC Operator Operation Manual	O032	SYSMAC -RTNC0□□□D	Learning an introduction of the CNC Operator and how to use it.	An introduction of the CNC Operator, installation procedures, basic operations, connection operations, and operating procedures for main functions are described.

Revision History

A manual revision code appears as a suffix to the catalog number on the front and back covers of the manual.

Cat. No. W582-E1-02

↑
Revision code

Revision code	Date	Revised content
01	September 2016	Original production
02	January 2019	Added compatible models.

Procedure to Use Sysmac Libraries

Procedure to Use Sysmac Libraries Installed Using the Installer

This section describes the procedure to use Sysmac Libraries that you installed using the installer.

There are two ways to use libraries.

- Using newly installed Sysmac Libraries
- Using upgraded Sysmac Libraries



Version Information

To use Sysmac Libraries, you need the Sysmac Studio version 1.14 or higher.

Using Newly Installed Libraries

- 1 Start the Sysmac Studio and open or create a new project in which you want to use Sysmac Libraries.

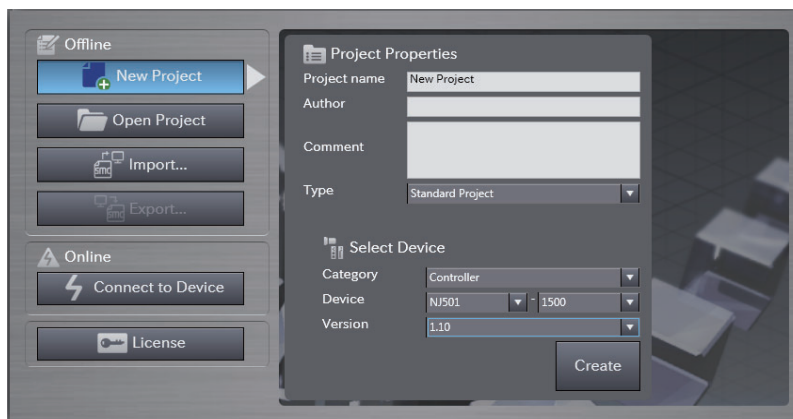

Precautions for Correct Use

If you create a new project, be sure to configure the settings as follows to enable the use of Sysmac Libraries. If you do not configure the following settings, you cannot proceed to the step 2 and later steps.

- Set the project type to Standard Project or Library Project.
- Set the device category to Controller.
- Set the device version to 1.01 or later.

2 Select Project – Library – Show References.

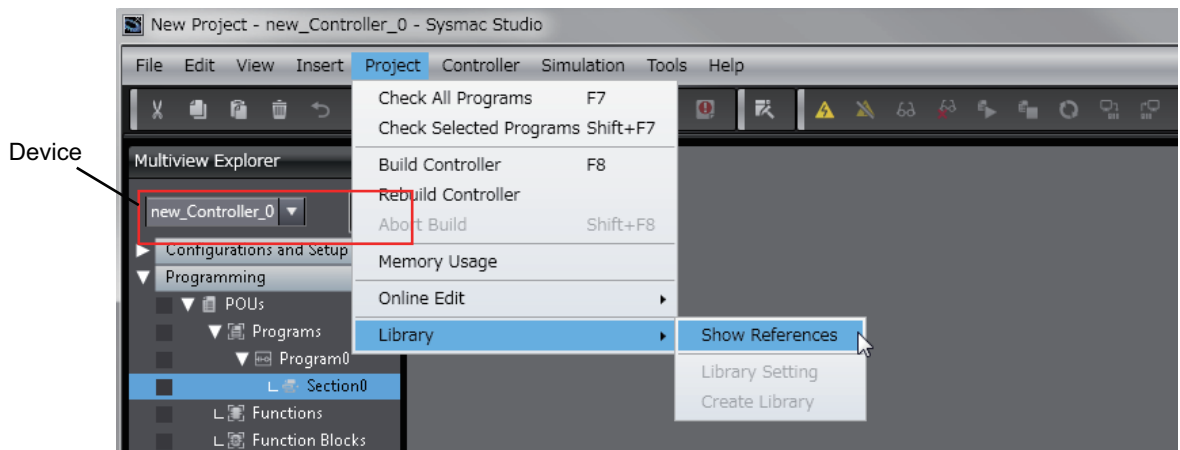

Precautions for Correct Use

If you have more than one registered device in the project, make sure that the device selected currently is an NJ/NX-series CPU Unit. If you do not select an NJ/NX-series CPU Unit as the device, Library References does not appear in the above menu. When the device selected currently is an NJ/NX-series CPU Unit, the device icon  is displayed in the Multiview Explorer.

3 Add the desired Sysmac Library to the list and click the OK Button.



The Sysmac Library file is read into the project.

Now, when you select the Ladder Editor or ST Editor, the function blocks and functions included in a Sysmac Library appear in the Toolbox.

For the procedure for adding and setting libraries in the above screen, refer to the *Sysmac Studio Version 1 Operation Manual (Cat. No. W504)*.

4 Insert the Sysmac Library's function blocks and functions into the circuit using one of the following two methods.

- Select the desired function block or function in the Toolbox and drag and drop it onto the programming editor.

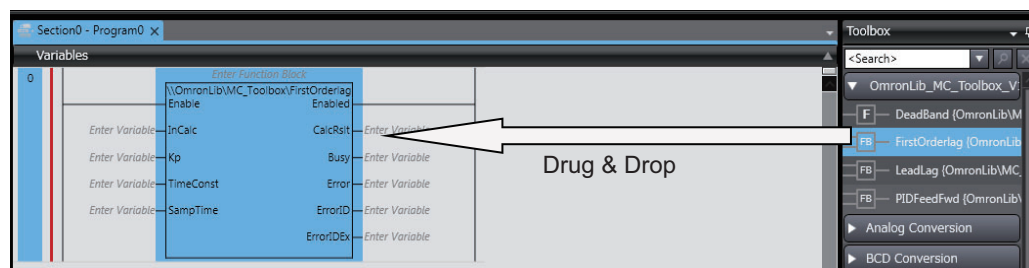

- Right-click the programming editor, select **Insert Function Block** in the menu, and enter the fully qualified name (\\name of namespace\\name of function block).

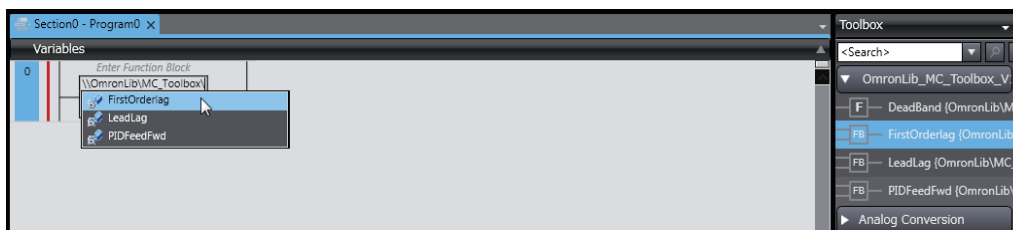

Using Upgraded Libraries

- 1 Start the Sysmac Studio and open a project in which any old-version Sysmac Library is included.
- 2 Select **Project – Library – Show References**.

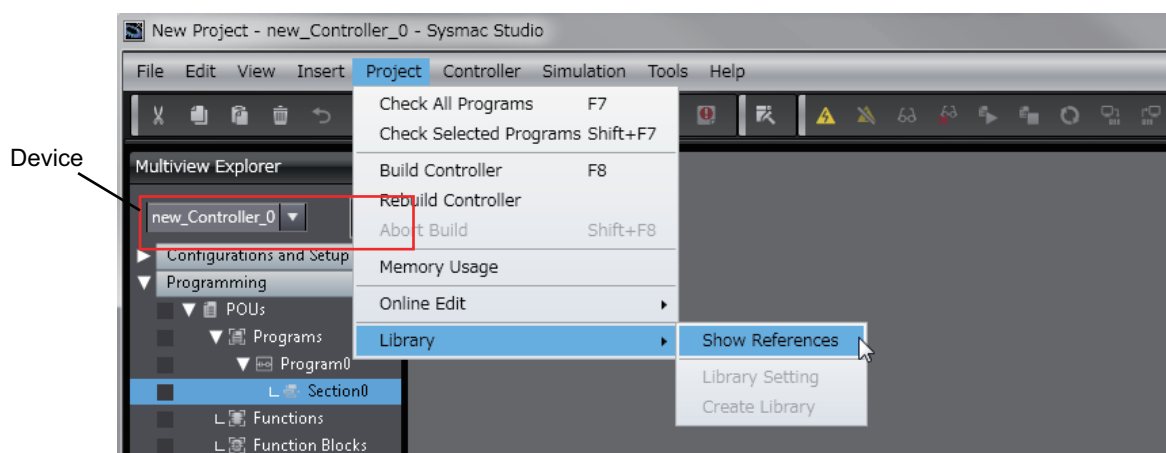

Precautions for Correct Use

If you have more than one registered device in the project, make sure that the device selected currently is an NJ/NX-series CPU Unit. Otherwise, Library References does not appear in the above menu. When the device selected currently is an NJ/NX-series CPU Unit, the device icon  is displayed in the Multiview Explorer.

- 3 Select an old-version Sysmac Library and click the **Delete Reference** Button.

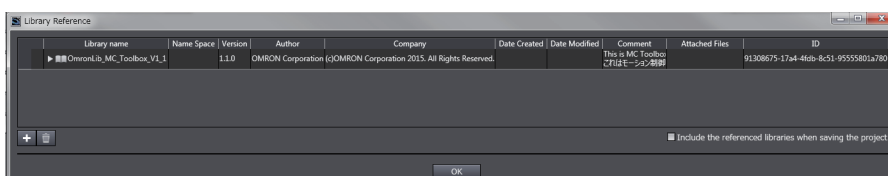

- 4 Add the desired Sysmac Library to the list and click the **OK** Button.

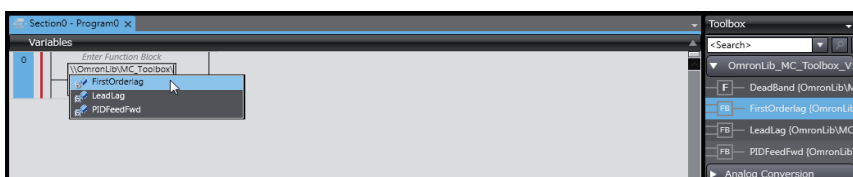



Precautions for Correct Use

After you upgrade the Sysmac Studio, check all programs and make sure that there is no error of the program check results on the Build Tab Page.

Select **Project – Check All Programs** from the Main Menu.

Procedure to Use Sysmac Libraries Uploaded from a CPU Unit

You can use Sysmac Libraries uploaded from a CPU Unit to your computer if they are not installed. The procedure to use uploaded Sysmac Libraries from a CPU Unit is as follows.

✓ Version Information

To use Sysmac Libraries, you need the Sysmac Studio version 1.14 or higher.

- 1 Start the Sysmac Studio and create a new project in which you want to use Sysmac Libraries.

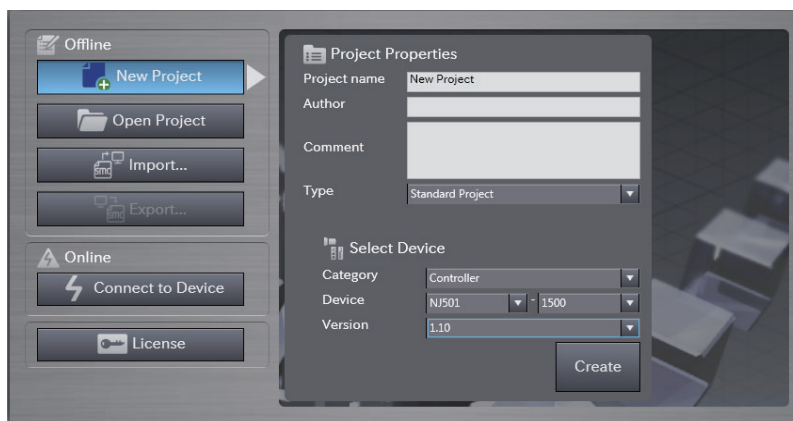

- 2 Connect the computer to the CPU Unit and place it online.
- 3 Upload POU in which any Sysmac Library is used to the computer.
Now, when you select the Ladder Editor or ST Editor, the function blocks and functions included in the Sysmac Library used in the uploaded POU appear in the Toolbox.
- 4 Insert the Sysmac Library's function blocks and functions into the circuit using one of the following two methods.
 - Select the desired function block or function in the Toolbox and drag and drop it onto the Ladder Editor.

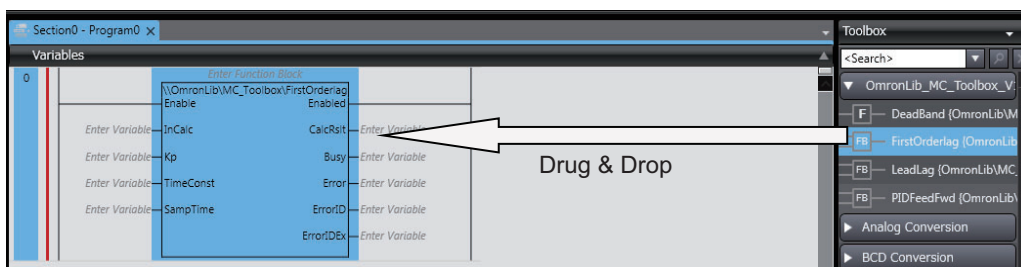

- Right-click the programming editor, select **Insert Function Block** in the menu, and enter the fully qualified name (\\name of namespace\name of function block).

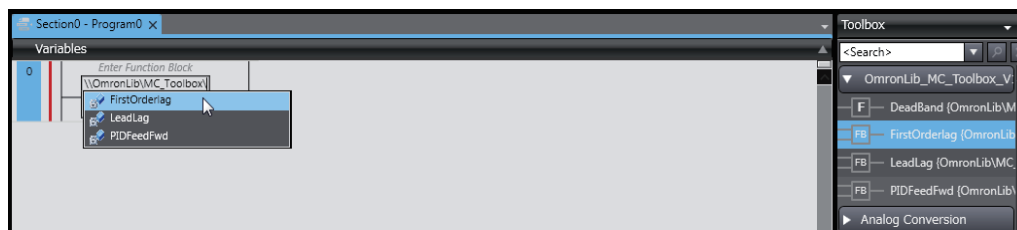

Precautions for Correct Use

- The Sysmac Studio installs library files of the uploaded Sysmac Studio to the specified folder on the computer if they are not present. However, the Sysmac Studio does not install library files to the specified folder on the computer if they are present.
The specified folder here means the folder in which library files are installed by the installer.
- Note that uploading Sysmac Libraries from a CPU Unit does not install the manual and help files for the Sysmac Libraries, unlike the case where you install them using the installer. Please install the manual and help files using the installer if you need them.

Common Specifications of Function Blocks

Common Variables

This section describes the specifications of variables (*EN*, *Execute*, *Enable*, *Abort*, *ENO*, *Done*, *CalcRslt*, *Enabled*, *Busy*, *CommandAborted*, *Error*, *ErrorID*, and *ErrorIDEx*) that are used for more than one function or function block. The specifications are described separately for functions, for execute-type function blocks, and for enable-type function blocks.

Definition of Input Variables and Output Variables

Common input variables and output variables used in functions and function blocks are as follows.

Variable	I/O	Data type	Function/function block type to use			Meaning	Definition
			Function block		Function		
			Execute-type	Enable-type			
EN	Input	BOOL			OK	Execute	The processing is executed while the variable is TRUE.
Execute			OK			Execute	The processing is executed when the variable changes to TRUE.
Enable				OK		Run	The processing is executed while the variable is TRUE.
Abort		BOOL	OK			Abort	The processing is aborted. You can select the aborting method.

Variable	I/O	Data type	Function/function block type to use			Meaning	Definition
			Function block		Function		
			Execute-type	Enable-type			
ENO	Output	BOOL			OK	Done	The variable changes to TRUE when the processing ends normally. It is FALSE when the processing ends in an error, the processing is in progress, or the execution condition is not met.
Done		BOOL	OK			Done	The variable changes to TRUE when the processing ends normally. It is FALSE when the processing ends in an error, the processing is in progress, or the execution condition is not met.
Busy		BOOL	OK	OK		Executing	The variable is TRUE when the processing is in progress. It is FALSE when the processing is not in progress.
CalcRslt		LREAL		OK		Calculation Result	The calculation result is output.
Enabled		BOOL		OK		Enabled	The variable is TRUE when the output is enabled. It is used to calculate the control amount for motion control, temperature control, etc.
Command Aborted		BOOL	OK			Command Aborted	The variable changes to TRUE when the processing is aborted. It changes to FALSE when the processing is re-executed the next time.
Error		BOOL	OK	OK		Error	This variable is TRUE while there is an error. It is FALSE when the processing ends normally, the processing is in progress, or the execution condition is not met.
ErrorID		WORD	OK	OK		Error Code	An error code is output.
ErrorIDEx		DWORD	OK	OK		Expansion Error Code	An expansion error code is output.

Execute-type Function Blocks

- Processing starts when *Execute* changes to TRUE.
- When *Execute* changes to TRUE, *Busy* also changes to TRUE. When processing is completed normally, *Busy* changes to FALSE and *Done* changes to TRUE.
- When continuously executes the function blocks of the same instance, change the next *Execute* to TRUE for at least one task period after *Done* changes to FALSE in the previous execution.
- If the function block has a *CommandAborted* (Instruction Aborted) output variable and processing is aborted, *CommandAborted* changes to TRUE and *Busy* changes to FALSE.
- If an error occurs in the function block, *Error* changes to TRUE and *Busy* changes to FALSE.
- For function blocks that output the result of calculation for motion control and temperature control, you can use the BOOL input variable *Abort* to abort the processing of a function block. When *Abort* changes to TRUE, *CommandAborted* changes to TRUE and the execution of the function block is aborted.

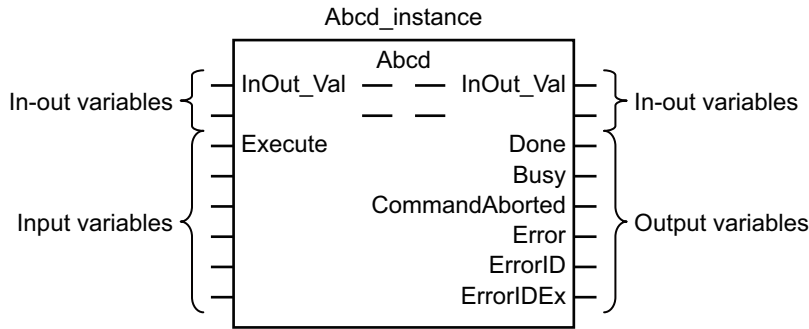

- If *Execute* is TRUE and *Done*, *CommandAborted*, or *Error* changes to TRUE, *Done*, *CommandAborted*, and *Error* changes to FALSE when *Execute* is changed to FALSE.
- If *Execute* is FALSE and *Done*, *CommandAborted*, or *Error* changes to TRUE, *Done*, *CommandAborted*, and *Error* changes to TRUE for only one task period.
- If an error occurs, the relevant error code and expansion error code are set in *ErrorID* (Error Code) and *ErrorIDEx* (Expansion Error Code). The error codes are retained even after *Error* changes to FALSE, but *ErrorID* is set to 16#0000 and *ErrorIDEx* is set to 16#0000 0000 when *Execute* changes to TRUE.

Timing Charts

This section provides timing charts for a normal end, aborted execution, and errors.

● Normal End

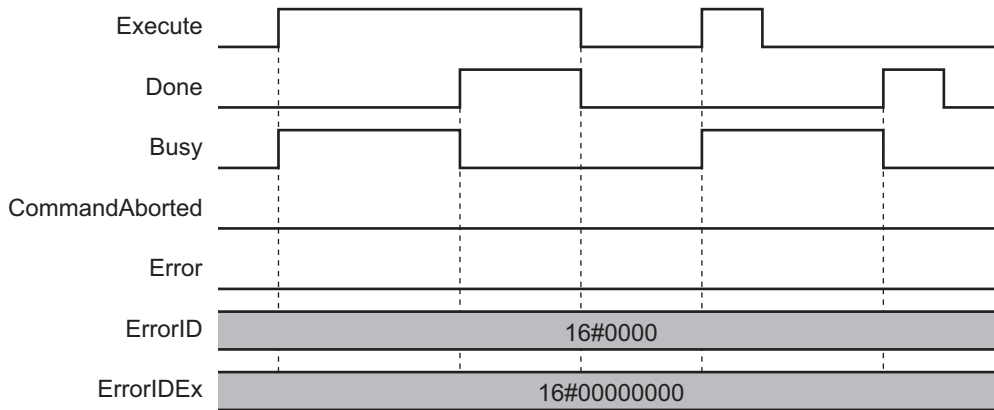

● Canceled Execution

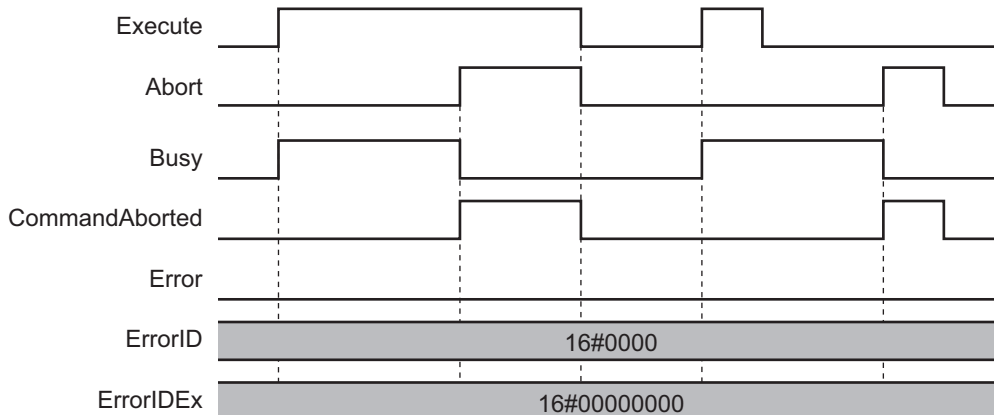

● Aborted Execution

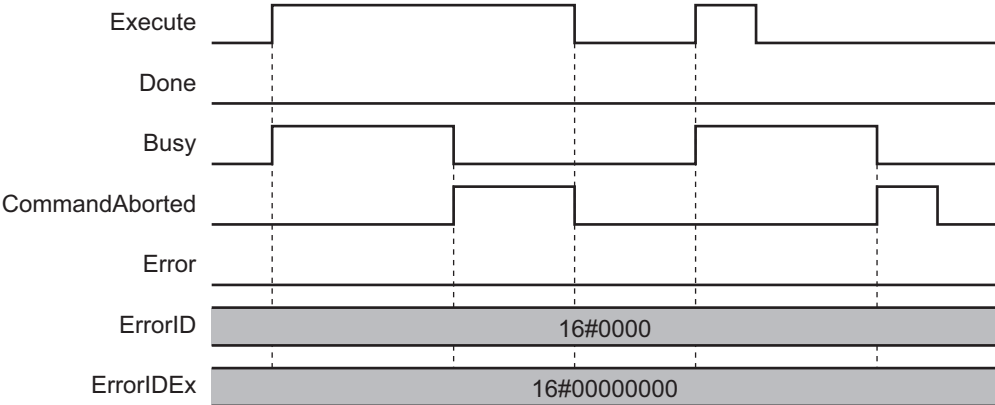

● Errors

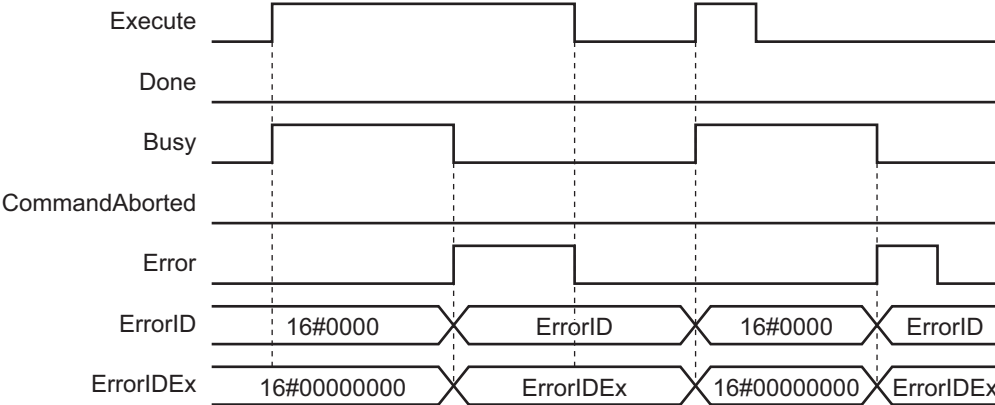

Enable-type Function Blocks

- Processing is executed while *Enable* is TRUE.
- When *Enable* changes to TRUE, *Busy* also changes to TRUE. *Enabled* is TRUE during calculation of the output value.
- If an error occurs in the function block, *Error* changes to TRUE and *Busy* and *Enabled* change to FALSE. When *Enable* changes to FALSE, *Enabled*, *Busy*, and *Error* change to FALSE.

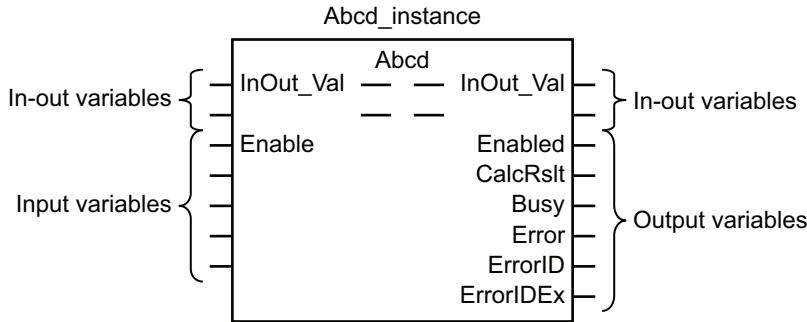

- If an error occurs, the relevant error code and expansion error code are set in *ErrorID* (Error Code) and *ErrorIDEx* (Expansion Error Code). The error codes are retained even after *Error* changes to FALSE, but *ErrorID* is set to 16#0000 and *ErrorIDEx* is set to 16#0000 0000 when *Enable* changes to TRUE.
- For function blocks that calculate the control amount for motion control, temperature control, etc., *Enabled* is FALSE when the value of *CalcRslt* (Calculation Result) is incorrect. In such a case, do not use *CalcRslt*. In addition, after the function block ends normally or after an error occurs, the value of *CalcRslt* is retained until *Enable* changes to TRUE. The control amount will be calculated based on the retained *CalcRslt* value, if it is the same instance of the function block that changed *Enable* to TRUE. If it is a different instance of the function block, the control amount will be calculated based on the initial value.

Timing Charts

This section provides timing charts for a normal end and errors.

● Normal End

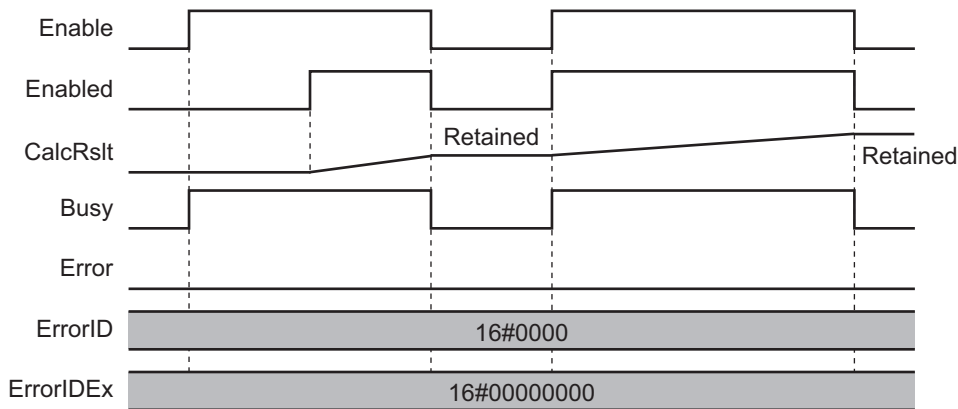

● Errors

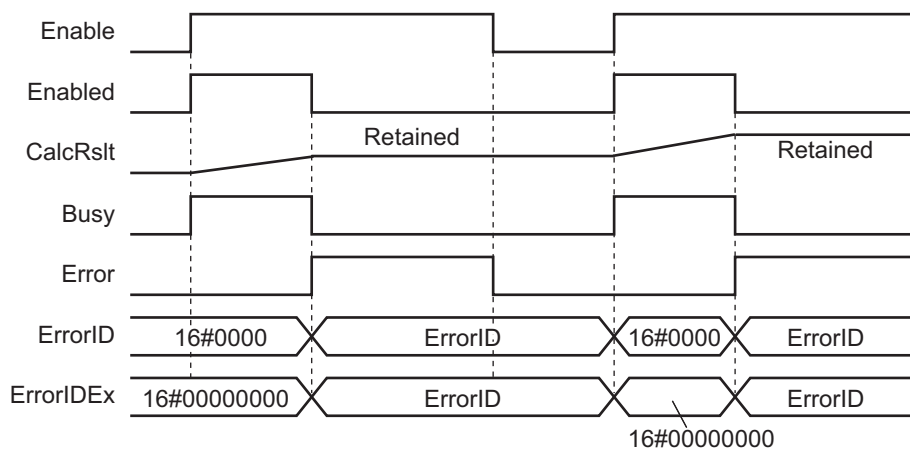

Precautions

This section provides precautions for the use of this function block.

Nesting

You can nest calls to this function block for up to four levels.

For details on nesting, refer to the *NJ/NX-series CPU Unit Software User's Manual* (Cat. No. W501).

Instruction Options

You cannot use the upward differentiation option for this function block.

Re-execution of Function Blocks

Execute-type function blocks cannot be re-executed by the same instance.

If you do so, the output value will be the initial value.

For details on re-execution, refer to the *NJ/NX-series CPU Unit Motion Control User's Manual* (Cat. No. W507).

Individual Specifications of Function Blocks

Function block name	Name	Page
GetSafetySignature	Read Safety Signature	P.32

GetSafetySignature

The GetSafetySignature function block reads the safety signature from the Safety CPU Unit specified on the EtherCAT Network.

Function block name	Name	FB/FUN	Graphic expression	ST expression
GetSafetySignature	Read Safety Signature	FB		<pre>GetSafetySignature_Instance(Execute, NodeAddress, NXUnitNumber, Done, SignatureCode, SignatureLastModified, Busy, Error, ErrorID, ErrorIDEx);</pre>

Library Information

Item	Description
Library file name	OmronLib_SF_Monitor_V1_0.slr
Namespace	OmronLib\SF_Monitor
Function block and function number	00165
Source code published/not published	Not published
Function block and function version	1.00

Compatible Models

Item	Name	Model numbers	Version
Automation Software	Sysmac Studio	SYSMAC-SE□□□□	Version 1.14 or higher
Device	CPU Unit	NX701-□□□□	Version 1.10 or later
		NJ101-□□□□	
		NJ501-□□□□	Version 1.07 or later
	NJ301-□□□□		
	IPC Motion Controller	NY532-1□□□	Version 1.12 or later
		NY512-1□□□	
Safety CPU Unit	NX-SL3□□□	Version 1.00 or later	
EtherCAT Coupler Unit		NX-ECC201	Version 1.2.1 or later
		NX-ECC202	
		NX-ECC203	Version 1.3 or later

Variables

Name	Meaning	I/O	Description	Valid range	Unit	Default
Execute	Execute	Input	Execute TRUE: Executes the function block. FALSE: Does not execute the function block.	Depends on data type.	---	FALSE
NodeAddress	Slave Node Address	Input	Specifies the node address of the EtherCAT Coupler Unit to which the Safety CPU Unit is mounted.	1 to 512* ¹	---	1
NXUnitNumber	NX Unit Number	Input	Specifies the NX Unit number of the Safety CPU Unit.	1 to 63	---	1
Done	Done	Output	Done TRUE: Normal end FALSE: Error end, execution in progress, or execution condition not met	Depends on data type.	---	---
Signature	Safety Signature	Output	Safety signature 16#0000: Safety validation has not been performed. Other than 16#0000: Safety signature	Depends on data type.	---	---
LastModified	Safety Signature Date Created	Output	Specifies the date the safety signature was created in UTC.	Depends on data type.	---	---
Busy	Executing	Output	Executing TRUE: Execution processing is in progress. FALSE: Execution processing is not in progress.	Depends on data type.	---	---
Error	Error	Output	Error TRUE: Error end FALSE: Normal end, execution in progress, or execution condition not met	Depends on data type.	---	---
ErrorID	Error Code	Output	This is the error ID for an error end. The value is WORD#16#0 for a normal end.	*2	---	---
ErrorIDEx	Expansion Error Code	Output	This is the error ID for an Expansion Unit Hardware Error. The value is DWORD#16#0 for a normal end.	*2	---	---

*1. The valid range is 1 to 192 for NJ-series CPU Units.

*2. For details, refer to *Troubleshooting* on page 34.

Function

- The GetSafetySignature function block reads the safety signature and safety signature date created for the Safety CPU Unit specified with *NodeAddress* and *NXUnitNumber*.
- For *NodeAddress*, specify the node address of the NX-ECC20□ EtherCAT Communications Coupler Unit to which the Safety CPU Unit is mounted.

Related System-defined Variables

Name	Meaning	Data type	Description
_EC_MBXSlavTbl	Message Communications Enabled Slave Table	Array[1..512* ¹] OF BOOL	This table indicates the slaves that can perform message communications. Slaves are given in the table in the order of slave node addresses. TRUE: Message communications are possible. FALSE: Message communications are not possible.

*1. The valid range is 1 to 192 for NJ-series CPU Units.

Precautions for Correct Use

- Execution of this function block will be continued until processing is ended even if the value of *Execute* changes to FALSE or the execution time exceeds the task period. The value of *Done* changes to TRUE when processing is ended. Use this to confirm normal ending of processing.
- This function block executes one EC_CoESDOWrite instruction or one EC_CoESDORead instruction within the part. Refer to the EC_CoESDOWrite instruction in the *NJ/NX-series Instructions Reference Manual* (Cat. No. W502) for the maximum number of instructions that can be executed at the same time.
- Do not turn OFF the power supply to the Controller or EtherCAT slave or stop EtherCAT communications until the processing for this function block ends normally or ends in an error.
- An error will occur in the following cases. *Error* will change to TRUE.
 - a) The EtherCAT master is not in a state that allows message communications.
 - b) The slave specified with *NodeAddress* does not exist.
 - c) The slave specified with *NodeAddress* is not in a state that allows communications.
 - d) The number of EtherCAT communications instructions exceeded the maximum number of instructions that can be executed at the same time.
- If safety validation has not been performed for the Safety CPU Unit specified by this function block, the value of *Signature* will be 16#0000.
- The date created for the safety signature that was read with this function block is the UTC value. Change it to the local time as required.

Troubleshooting

Error code	Expansion error code	Status	Description	Correction
16#0000	16#00000000	Normal End	---	---
16#0400	16#00000000	Input Value Out of Range	The value of <i>NodeAddress</i> is out of range. The value of <i>NXUnitNumber</i> is out of range.	Set the value of <i>NodeAddress</i> correctly. Set the value of <i>NXUnitNumber</i> correctly.
16#1800	16#00000000	EtherCAT Communications Error	The EtherCAT network is not in a usable status.	Check the operation status of the EtherCAT network by checking the status of the EtherCAT master. Use this information to correct the cause of the problem.

Error code	Expansion error code	Status	Description	Correction
16#1801	16#00000000	EtherCAT Slave Does Not Respond	The target slave does not exist.	Specify an existing node address.
			The target slave is not in a usable status.	Check the status of the target EtherCAT slave. Make sure that the target slave is in a usable status.
16#1802	16#00000000	EtherCAT Time-out	Communications with the target slave timed out.	Check the operating status of the target slave and correct the cause of the problem.
16#1803	16#00000000	Reception Buffer Overflow	The receive data from an EtherCAT slave overflowed the receive buffer.	Set the size of the reception buffer to a value larger than the size of the receive data from the slave.
16#1804	SDO Abort Code ^{*1}	SDO Abort Error	The cause of this error depends on the specifications of the EtherCAT slave.	Refer to the manual for the EtherCAT slave and correct the problem.
16#1808	16#00000000	Communications Resource Overflow	More than 32 EtherCAT communications instructions were executed at the same time.	Correct the user program so that no more than 32 EtherCAT communications instructions are executed at the same time.
16#3CE8	16#00000001	Unsupported Slave	The communications coupler does not support this function block.	Check that the specified node address is for an NX-ECC20□ EtherCAT Communications Coupler.
	16#00000002	Unsupported Version	The version of the communications coupler does not support this function block.	Confirm that the specified communications coupler version is listed in <i>Compatible Models</i> on page 32.
	16#00000003	NX Unit Does Not Exist	The target NX Unit does not exist.	Check that the Unit configuration is correct.
	16#00000004	Unsupported NX Unit	The device does not support this function block.	Check that the device with the specified node address and NX Unit Number is an NX-SL3□□□□ Safety CPU Unit.

*1. Refer to *SDO Abort Codes* in the *NJ/NX-series Instructions Reference Manual* (Cat. No. W502) for a list of SDO abort codes.

Sample Programming

This sample programming reads the safety signature for the specified Safety CPU Unit.

Conditions

- The Safety CPU Unit is mounted at the following node address and NX Unit number.

Node address	10
NX Unit number	1

- Safety validation has been performed for the Safety CPU Unit.

Processing

- 1 Make sure that the target slave is in a state that allows communications and that the same instance is not being executed.

2 Execute GetSafetySignature_instance.

LD

● Internal Variables

Name	Data type	Default	Comment
GetSafetySignature_in- stance	OmronLib\SF_Monitor\GetSafetySig- nature		
Init_Trigger	BOOL		
GetSafetySignature_Trigger	BOOL		GetSafetySignature exe- cution condition
GetSafetySignature_Busy	BOOL		
NodeAddress	UINT	10	Target Node Address
NXUnitNumber	USINT	1	Target NX Unit Address
SignatureCode	WORD		Safety Signature: CRC data
SignatureLastModified	DATE_AND_TIME		Safety Signature: Last Modified

● External Variables

Name	Data type	Constant	Comment
_EC_MBXSlavTbl	ARRAY[1..N *1] OF BOOL	✓	

*1. N = 192 for NJ501, NJ301, and NJ101. N = 512 for NX701.

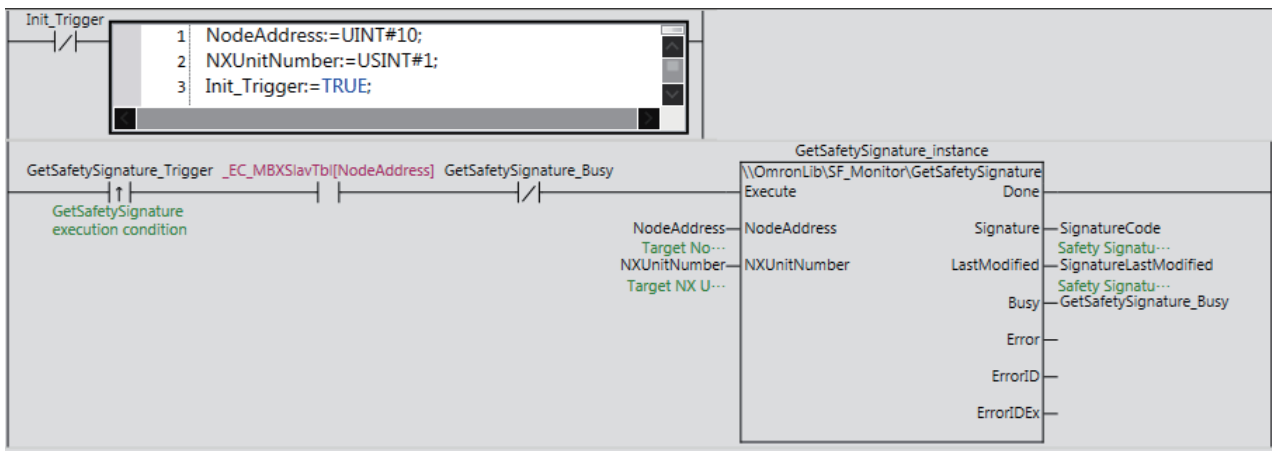

ST

● Internal Variables

Name	Data type	Default	Comment
GetSafetySignature_in- stance	OmronLib\SF_Monitor\GetSafetySig- nature		
GetSafetySignature_Trig- ger	BOOL		GetSafetySignature exe- cution condition
GetSafetySignature_Busy	BOOL		
NodeAddress	UINT	10	Target Node Address
NXUnitNumber	USINT	1	Target NX Unit Address

Name	Data type	Default	Comment
SignatureCode	WORD		Safety Signature: CRC data
SignatureLastModified	DATE_AND_TIME		Safety Signature: Last Modified
LastTrigger	BOOL		
OperatingStart	BOOL		
Operating	BOOL		

● External Variables

Name	Data type	Constant	Comment
_EC_MBXSlavTbl	ARRAY[1..N *1] OF BOOL	✓	

*1. N = 192 for NJ501, NJ301, and NJ101. N = 512 for NX701.

```
// Detect when Trigger changes to TRUE.
IF (GetSafetySignature_Trigger=TRUE) AND (LastTrigger=FALSE) AND
(_EC_MBXSlavTbl[NodeAddress]=TRUE) AND (GetSafetySignature_Busy=FALSE) THEN
NodeAddress:=UINT#10;
NXUnitNumber:=USINT#1;
OperatingStart:=TRUE;
END_IF;
LastTrigger:=GetSafetySignature_Trigger;

// Initialize GetSafetySignature instruction.
IF (OperatingStart=TRUE) THEN
Operating:=TRUE;
OperatingStart:=FALSE;
END_IF;

// Execute GetSafetySignature instruction.
GetSafetySignature_instance(Execute:=Operating,
NodeAddress:=NodeAddress,
NXUnitNumber:=NXUnitNumber,
Signature=>SignatureCode,
LastModified=>SignatureLastModified,
Busy=>GetSafetySignature_Busy);
IF (Operating=TRUE) AND (GetSafetySignature_instance.Done=TRUE) THEN
// Processing after normal end.
Operating:=FALSE;
ELSIF (Operating=TRUE) AND (GetSafetySignature_instance.Error=TRUE) THEN
// Processing after error end.
Operating:=FALSE;
END_IF;
```

Appendix

Referring to Library Information

When you make an inquiry to OMRON about the library, you can refer to the library information to identify the library to ask about.

The library information is useful in identifying the target library among the libraries provided by OMRON or created by the user.

The library information consists of the attributes of the library and the attributes of function blocks and functions contained in the library.

- Attributes of libraries
Information for identifying the library itself
- Attributes of function blocks and functions
Information for identifying the function block and function contained in the library

Use the Sysmac Studio to access the library information.

Attributes of Libraries, Function Blocks and Functions

The following attributes of libraries, function blocks and functions are provided as the library information.

● Attributes of Libraries

No.*1	Attribute	Description
(1)	Library file name	The name of the library file
(2)	Library version	The version of the library
(3)	Author	The name of creator of the library
(4)	Comment	The description of the library*2

*1. These numbers correspond to the numbers shown on the screen images in the next section, *Referring to Attributes of Libraries, Function Blocks and Functions* on page 41.

*2. It is provided in English and Japanese.

● Attributes of Function Blocks and Functions

No.*1	Attribute	Description
(5)	FB/FUN name	The name of the function block or function
(6)	Name space	The name of name space for the function block or function
(7)	FB/FUN version	The version of the function block or function
(8)	Author	The name of creator of the function block or function
(9)	FB/FUN number	The function block number or function number
(10)	Comment	The description of the function block or function*2

*1. These numbers correspond to the numbers shown on the screen images in the next section, *Referring to Attributes of Libraries, Function Blocks and Functions* on page 41.

*2. It is provided in English and Japanese.

Referring to Attributes of Libraries, Function Blocks and Functions

You can refer to the attributes of libraries, function blocks and functions of the library information at the following locations on the Sysmac Studio.

- Library Reference Dialog Box
- Toolbox Pane
- Ladder Editor

(a) Library Reference Dialog Box

When you refer to the libraries, the library information is displayed at the locations shown below.

(1)Library file name (2)Library version (3)Library author (4)Library comment

Library name	Name Space	Version	Author	Company	Date Creat	Date Modi	Comment
OmronLib_MC_Toolbox_V1_1		1.1.0	OMRON Corporation	(c)OMRON Corporation 2015. All Rights Reserved.			This is MC Toolbox library. これはモーション制御ツールボックスライ
POU							
Programs							
Functions							
DeadBand (OmronLib_MC_Toolbox)	OmronLib\MC_Toolbo	1.1.0	OMRON Corporation		03/16/2015	08/10/201	No.00006 The DeadBand function block cont 処理結果にオフセットが発生させないデ
FirstOrderlag (OmronLib_MC_Toolbox)	OmronLib\MC_Toolbo	1.1.0	OMRON Corporation		04/01/2015	08/10/201	No.00004 The FirstOrderLag function block p 設定されたパラメータテーブルに従って、
LeadLag (OmronLib_MC_Toolbox)	OmronLib\MC_Toolbo	1.1.0	OMRON Corporation		04/01/2015	08/10/201	No.00005 The LeadLag function block perfor 設定されたパラメータテーブルに従って、
PIDFeedFwd (OmronLib_MC_Toolbox)	OmronLib\MC_Toolbo	1.1.0	OMRON Corporation		04/01/2015	08/10/201	No.00003 The PIDFeedFwd function block pe 設定されたパラメータテーブルに従って、

(5)FB/FUN name (6)Name space (7)FB/FUN version (8)FB/FUN author (10)FB/FUN comment

Namespace - Using

In/Out	Name	In/Out	Data Type	Edge	Initial Value	Retain	Constant	Comment
Externals	Enable	Input	BOOL	No Edge	False	<input type="checkbox"/>	<input type="checkbox"/>	
	InCalc	Input	LREAL	No Edge	0.0	<input type="checkbox"/>	<input type="checkbox"/>	
	Kp	Input	LREAL	No Edge	1.0	<input type="checkbox"/>	<input type="checkbox"/>	
	TimeConst	Input	LREAL	No Edge	1.0	<input type="checkbox"/>	<input type="checkbox"/>	
	SampTime	Input	LREAL	No Edge	1.0	<input type="checkbox"/>	<input type="checkbox"/>	
	Enabled	Output	BOOL	No Edge		<input type="checkbox"/>	<input type="checkbox"/>	

OK

(b) Toolbox Pane

Select a function block and function to display its library information at the bottom of the Toolbox Pane.

The text “by OMRON” which is shown on the right of the library name (1) indicates that this library was provided by OMRON.

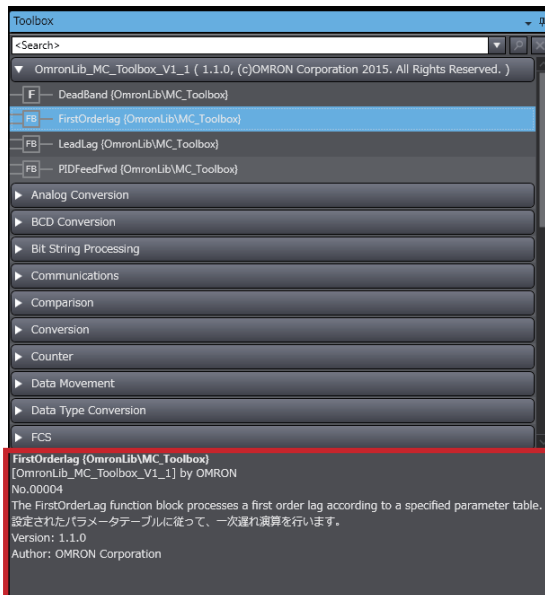

- (5)FB/FUN name (6)Name space
- (1)Library file name
- (9)FB/FUN number
- (10)FB/FUN comment
- (7)FB/FUN version
- (8)FB/FUN author

(c) Ladder Editor

Place the mouse on a function block and function to display the library information in a tooltip.

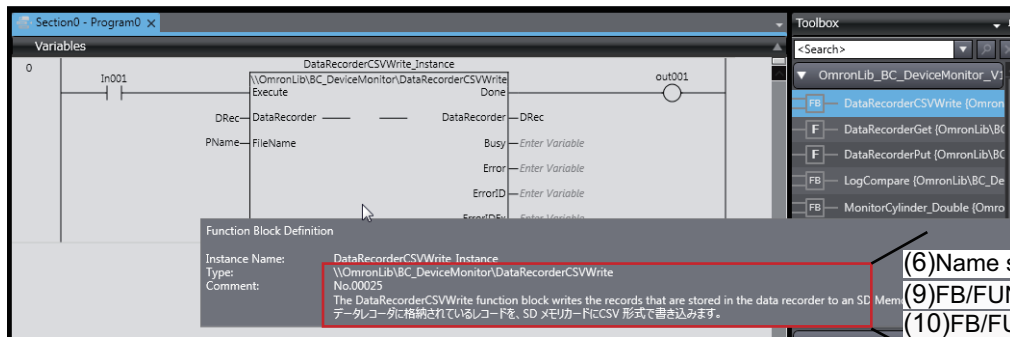

- (6)Name space (5)FB/FUN name
- (9)FB/FUN number
- (10)FB/FUN comment

Referring to Function Block and Function Source Codes

You can refer to the source codes of function blocks and functions provided by OMRON to customize them to suit the user's environment.

User function blocks and user functions can be created based on the copies of these source codes.

The following are the examples of items that you may need to customize.

- Customizing the size of arrays to suit the memory capacity of the user's Controller
- Customizing the data types to suit the user-defined data types

Note that you can access only function blocks and functions whose Source code published/not published is set to Published in the library information shown in their individual specifications.

Use the following procedure to refer to the source codes of function blocks and functions.

- 1 Select a function block or function in the program.

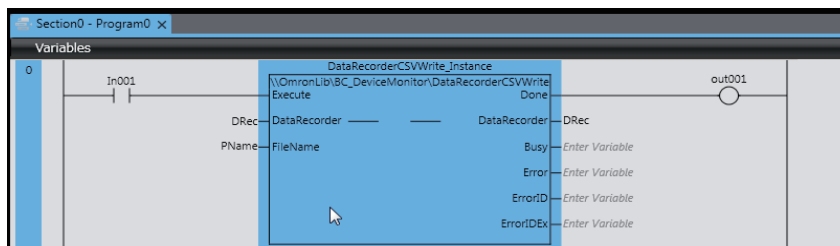

- 2 Double-click or right-click and select **To Lower Layer** from the menu.

The source code is displayed.

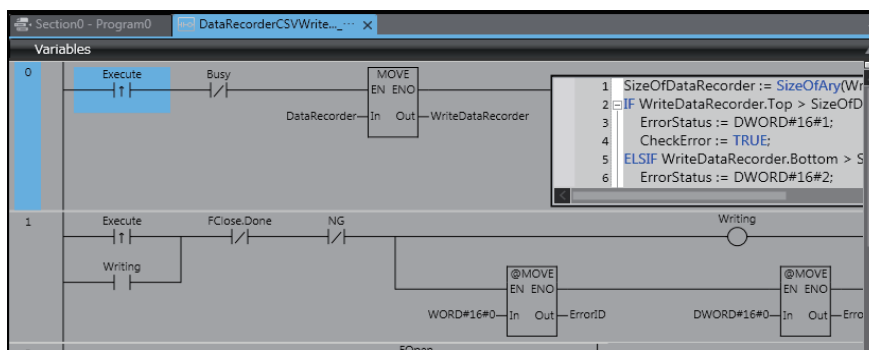

Precautions for Correct Use

For function blocks and functions whose source codes are not published, the following dialog box is displayed in the above step 2. Click the **Cancel** button.



OMRON Corporation Industrial Automation Company
Kyoto, JAPAN

Contact: www.ia.omron.com

Regional Headquarters

OMRON EUROPE B.V.

Wegalaan 67-69, 2132 JD Hoofddorp
The Netherlands
Tel: (31)2356-81-300/Fax: (31)2356-81-388

OMRON ELECTRONICS LLC

2895 Greenspoint Parkway, Suite 200
Hoffman Estates, IL 60169 U.S.A.
Tel: (1) 847-843-7900/Fax: (1) 847-843-7787

OMRON ASIA PACIFIC PTE. LTD.

No. 438A Alexandra Road # 05-05/08 (Lobby 2),
Alexandra Technopark,
Singapore 119967
Tel: (65) 6835-3011/Fax: (65) 6835-2711

OMRON (CHINA) CO., LTD.

Room 2211, Bank of China Tower,
200 Yin Cheng Zhong Road,
PuDong New Area, Shanghai, 200120, China
Tel: (86) 21-5037-2222/Fax: (86) 21-5037-2200

Authorized Distributor:

© OMRON Corporation 2016-2019 All Rights Reserved.
In the interest of product improvement,
specifications are subject to change without notice.

Cat. No. W582-E1-02

0119