

Motor Condition Monitoring Devices

K6CM series

Application Guide

Pump system application

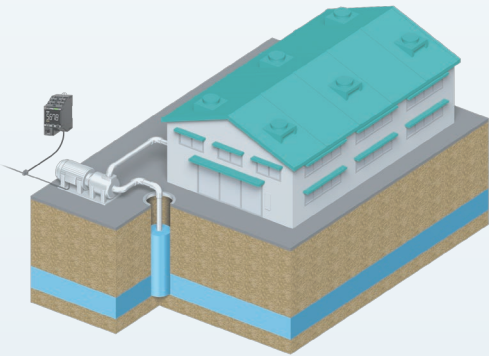

Fan system application

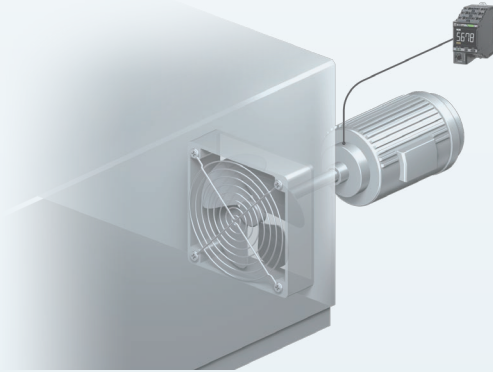

Stirring system application

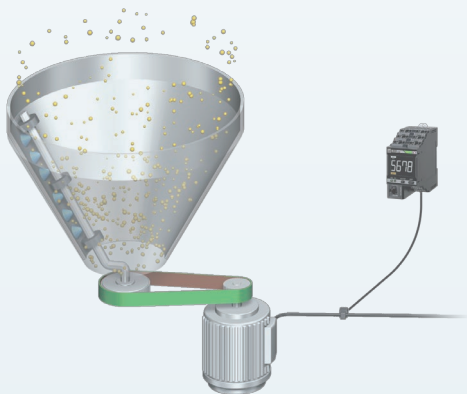

Transport system application

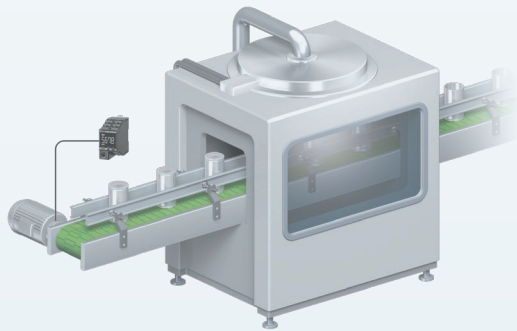

Degradation Progress and Failure Mode

Please select the optimal model for the type of failure mode you want to detect.

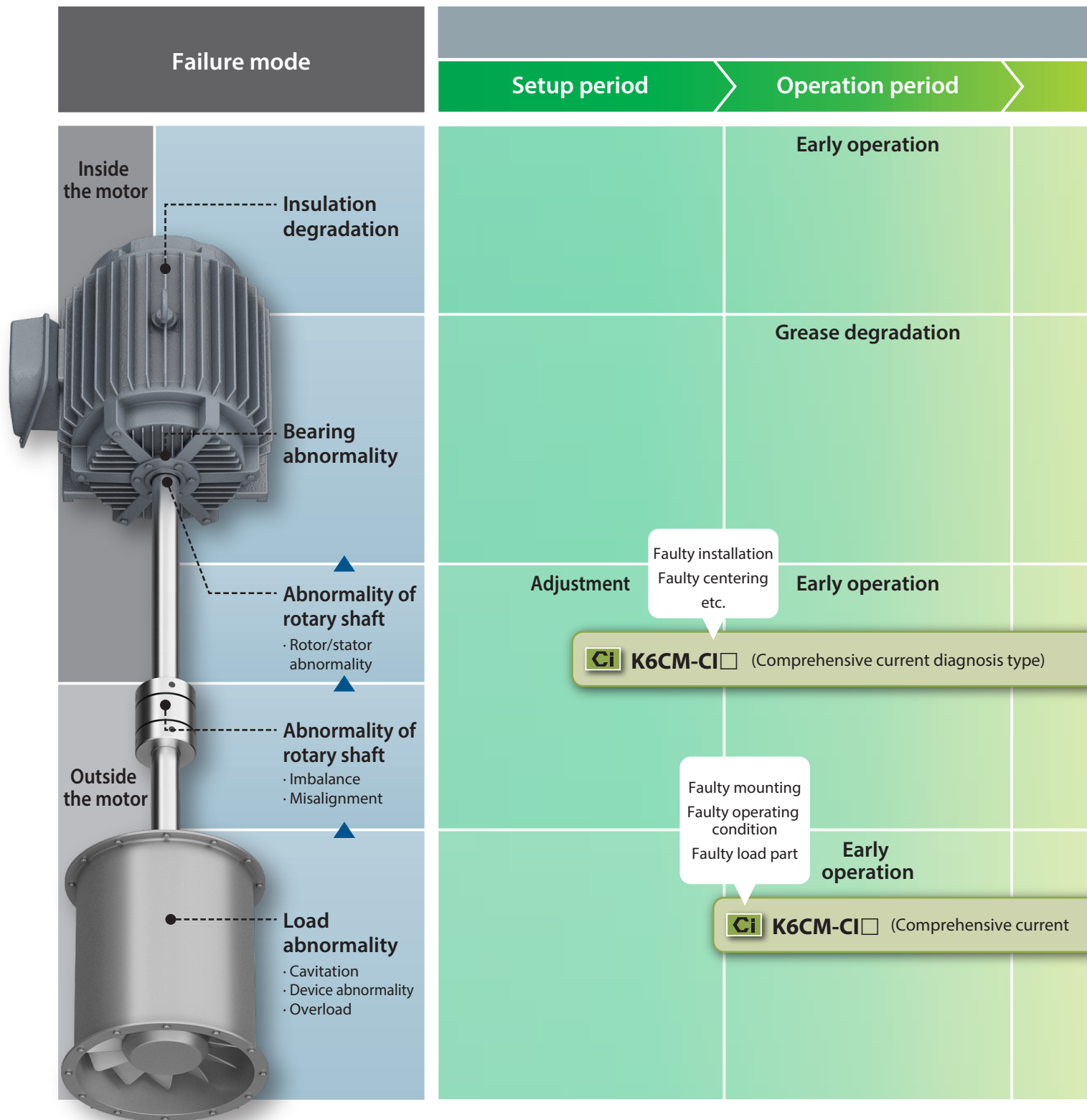

Motor and load condition

Degradation progress period

Breakdown period

Insulation degradation



 **K6CM-IS** (Insulation resistance monitoring type) [Insulation degradation]

Insulation breakdown

Bearing damage



 **K6CM-VB** (Vibration & temperature monitoring type) [Acceleration]

Bearing breakdown



 **K6CM-CI** (Comprehensive current diagnosis type) [Degradation level]

Degradation progress of motor

[Degradation level]

 **K6CM-VB** (Vibration & temperature monitoring type) [Velocity]

Degradation progress of load

diagnosis type) [Degradation level]

 **K6CM-VB** (Vibration & temperature monitoring type) [Velocity]

 **K6CM-CI** (Comprehensive current diagnosis type) [Overcurrent]

 **K6CM-VB** (Vibration/temperature monitoring type) [Temperature]

The measurement value in each model is a typical example.

Degradation Progress and Failure Mode P. 2

I. Pump system application

- Washing pumps for automotive components..... P. 5
- Cooling water circulation pumps P. 6
- Hydraulic pumps..... P. 7
- Well pumps..... P. 8

II. Fan system application

- Oven cooler fan motors P. 9
- Ventilation fans in odorous gas treatment facilities P. 10
- Fan motors for air handling units P. 11
- Cooling tower fans P. 12
- Heat exhaust fan P. 14
- Pressure adjustment blower P. 16

III. Transport system application

- Conveyor system P. 17
- Transport conveyor..... P. 18

IV. Stirring system application

- Dryers..... P. 19
- Homogenizers P. 20
- Storage tank mixer P. 21
- Can seamer P. 22



I. Pump system application

Comprehensive current diagnosis type

Pump system

K6CM Target Application

Washing pumps for automotive components

Facility details

Pump for washing.
Motor-driven pump sends washing water to the washing tank.

Motor operation conditions

11kw/200V/4poles
Inverter drive frequency: 60Hz

Failure mode

Load abnormality (Cavitation)

Detection parameters

Degradation level 1

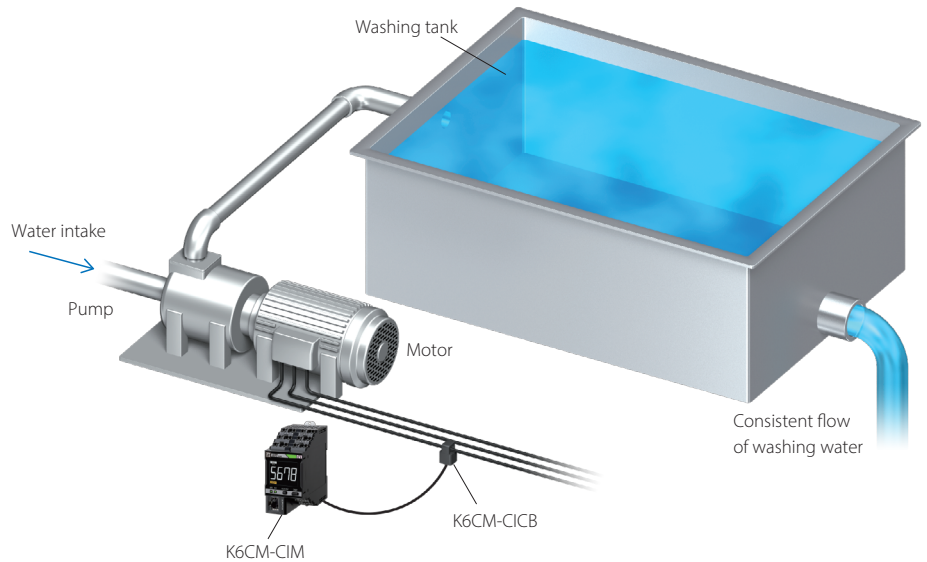

Degradation level 1 measurement results obtained from K6CM-CI□

The current waveform data *

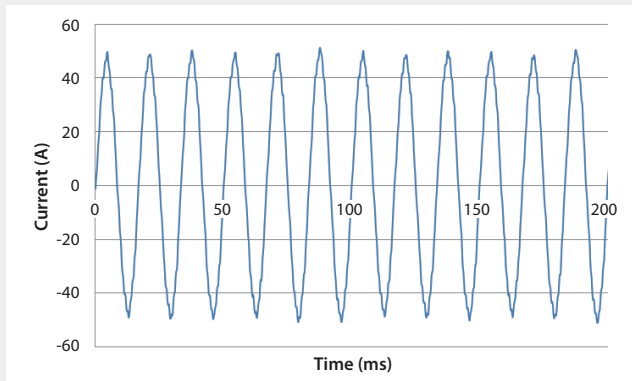

Normal Condition

Measurement value under normal operation: **20**

* K6CM does not output electric current waveform data.

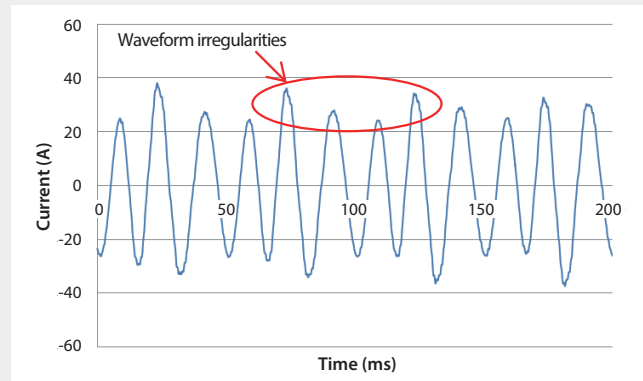

Abnormal Condition

Measurement value under abnormal operation: **75**

Abnormal operation: Air bubble has entered the pump, causing an air lock

Alarm threshold degradation level 1 for this application (examples)

Alarm threshold (Warning)	30
Alarm threshold (Critical)	50

Expected implementation effects

Detects air locks in pumps and other abnormal conditions so that the system can be maintained before degradation causes it to shut down.



I. Pump system application

Vibration/Temperature monitoring type

Pump system

K6CM Target Application

Cooling water circulation pumps

Facility details

Pump for circulating water throughout the facility.

Motor operation conditions

110kW/380V/4poles
Inverter drive frequency: 52Hz

Failure mode

Bearing anomalies

Detection parameters

Acceleration

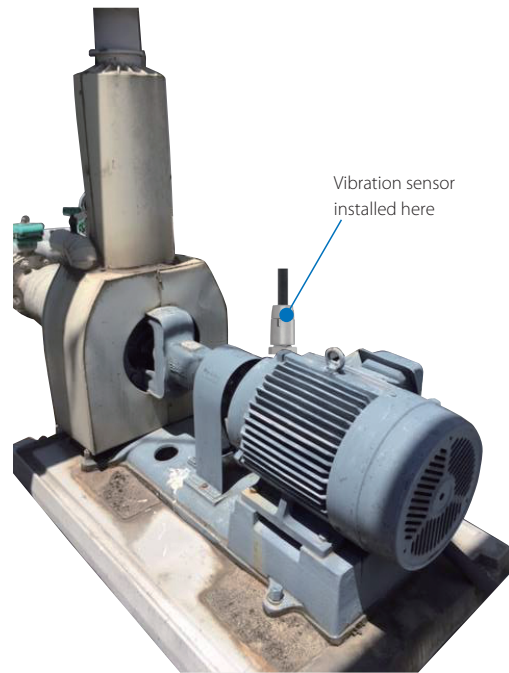

Acceleration measurement results obtained from K6CM-VBM

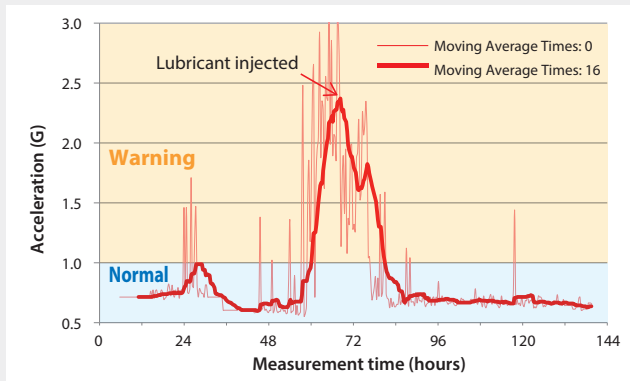

Measurement value under abnormal operation:

1.5 G or more

Bearing not sufficiently lubricated

Measurement value under normal operation: **around 0.6 G**

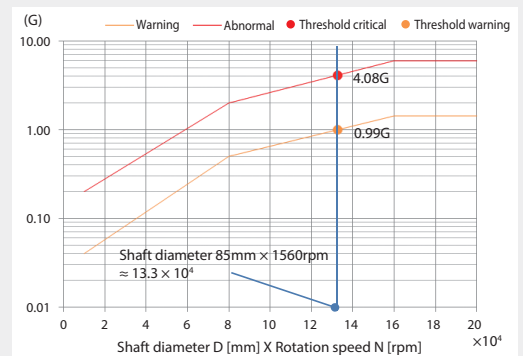

Alarm threshold acceleration for this application (examples)

Alarm threshold (Warning) 0.99G

Alarm threshold (Critical) 4.08G

Expected implementation effects

Detects when bearing grease has degraded or dried up, or when foreign matter has entered the system.



I. Pump system application

Comprehensive current diagnosis type

K6CM Target Application Hydraulic pumps

Facility details

Motors for hydraulic pumps in hydraulic facilities

Motor operation conditions

37kW/200V/6poles
Direct connection to commercial power supply: 60Hz
* Measured at fixed hydraulic pressure

Failure mode

Deterioration over time

Detection parameters

Degradation level 1

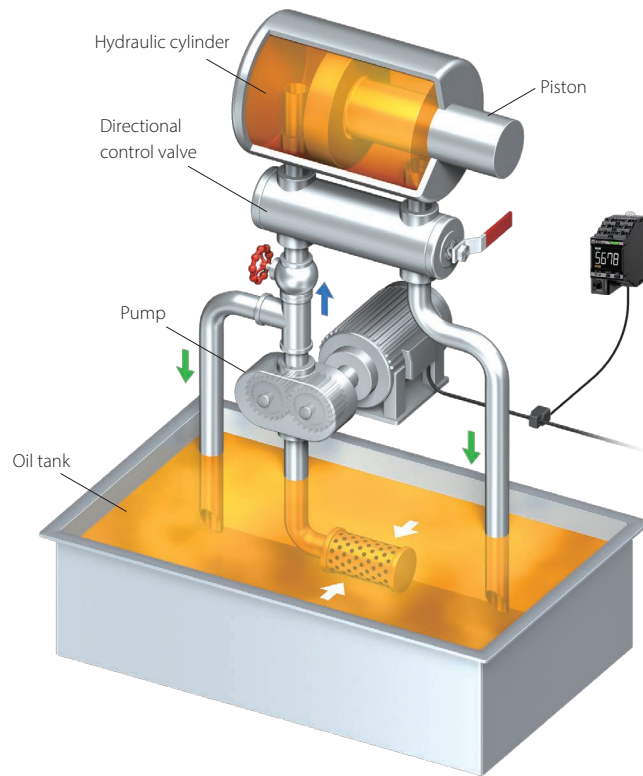

Pump system

Degradation level 1 measurement results obtained from K6CM-CI□

Degradation level log data

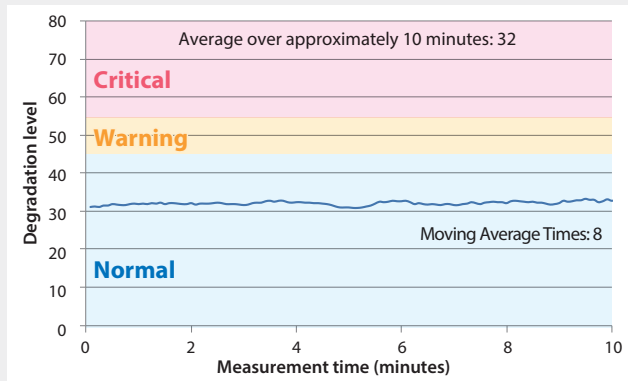

Normal Condition

Measurement value under normal operation: **32**

Pump initial installation

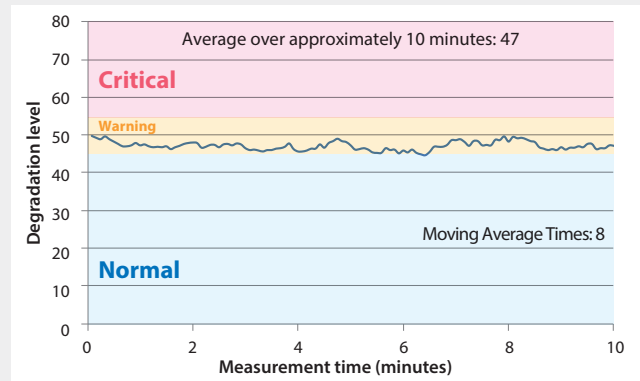

Warning Condition

Measurement value under warning operation: **47**

Pump installed over 10 years ago

Alarm threshold degradation level 1 for this application (examples)

Alarm threshold (Warning) **45**

Alarm threshold (Critical) **55**

Expected implementation effects

Enables the user to assess the right timing for maintenance based on the degree of deterioration instead of elapsed time.
Automatically notifies the user when to perform maintenance.

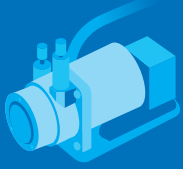

I. Pump system application

Comprehensive current diagnosis type

Pump system

K6CM Target Application

Well pumps

Facility details

Pump for extracting water from a well.

Motor operation conditions

7.5kw/200V/4poles
Inverter drive frequency: 25Hz

Failure mode

Deterioration over time

Detection parameters

Degradation level 1

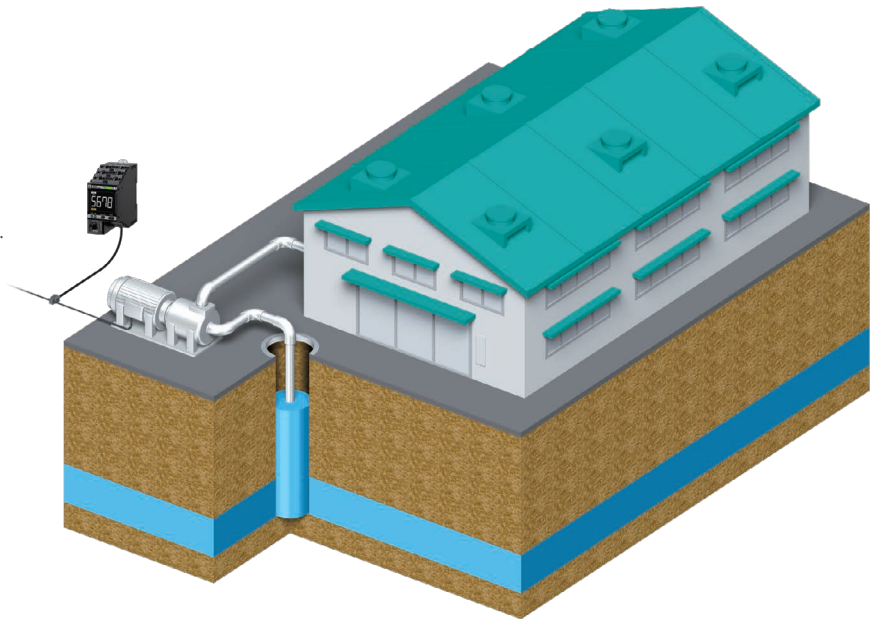

Degradation level 1 measurement results obtained from K6CM-CI□

Degradation level log data

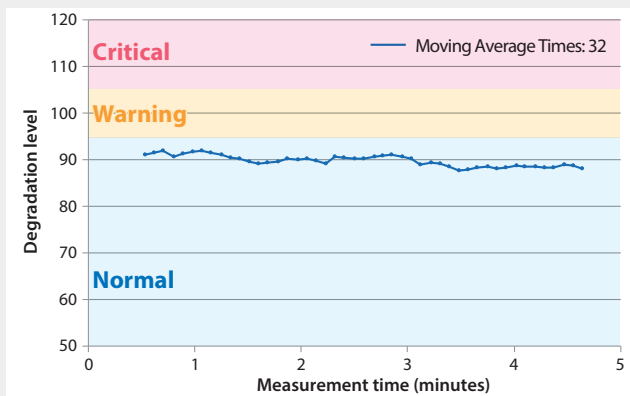

Normal Condition

Measurement value under normal operation: **90**

Pump installed 2 years ago

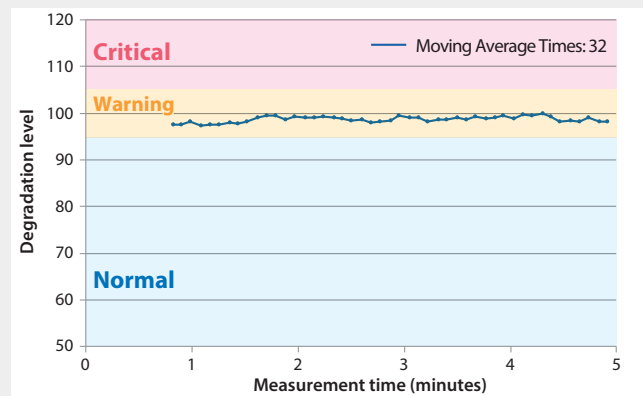

Warning Condition

Measurement value under warning operation: **99**

Pump installed over 10 years ago

Alarm threshold degradation level 1 for this application (examples)

Alarm threshold (Warning)	95
Alarm threshold (Critical)	105

Expected implementation effects

Enables preventative maintenance for facilities that cannot be visually inspected and also the users to assess the right timing for maintenance based on the degree of deterioration instead of elapsed time.

Automatically notifies the user when to perform maintenance.



II. Fan system application

Vibration/Temperature monitoring type

K6CM Target Application

Oven cooler fan motors

Facility details

Cooling fan for metal can drying oven.

Motor operation conditions

18.5kW/200V/4poles

Inverter drive frequency: 30Hz

Failure mode

Deterioration over time

Detection parameters

Acceleration

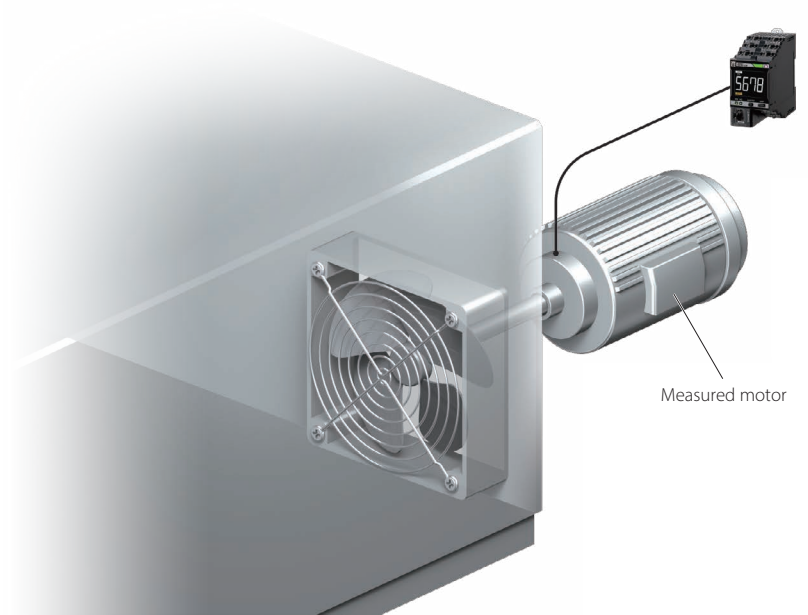

Fan system

Acceleration measurement results obtained from K6CM-VBM

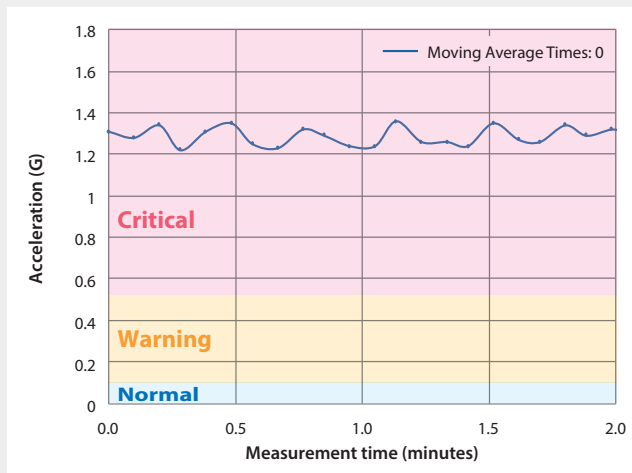

Measurement value of motor that has not been maintained for seven years

1.25 G

Abnormal condition value

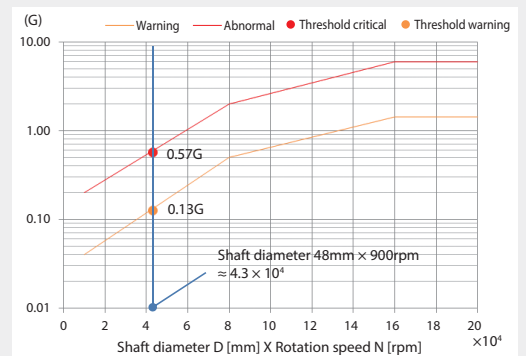

Threshold for this application (examples)

Alarm threshold (Warning) 0.13G

Alarm threshold (Critical) 0.57G

Expected implementation effects

Enables the user to assess the right timing for maintenance based on the degree of deterioration instead of elapsed time.

Automatically notifies the user when to perform maintenance.



II. Fan system application

Vibration/Temperature monitoring type

K6CM Target Application

Ventilation fans in odorous gas treatment facilities

Facility details

Ventilation fans in odorous gas treatment facilities Purifies air before releasing it outside by removing odorous components using activated carbon.

Motor operation conditions

22kW/400V

Driving the motor by direct connection to commercial power supply: 50Hz

Failure mode

Deterioration over time

Detection parameters

Acceleration/Velocity

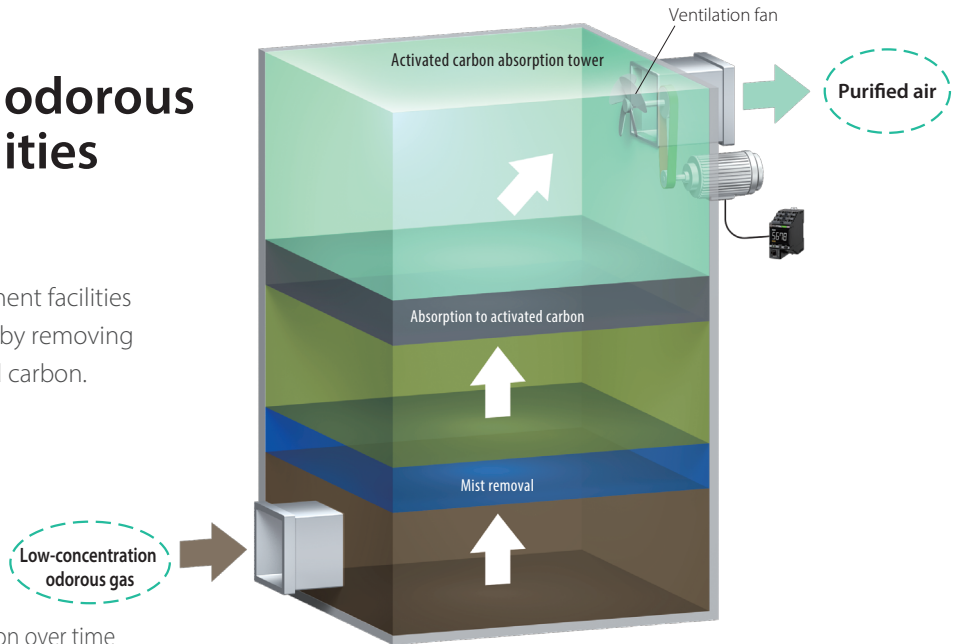

Acceleration/Velocity measurement results obtained from K6CM-VBM

Acceleration measurement results

Measurement value under normal operation:
0.15G
Normal

Measurement value under abnormal operation:
1.30G
motor making abnormal noise

Velocity measurement results

Measurement value under normal operation:
1.9mm/s
Normal

Measurement value under abnormal operation:
2.9mm/s
motor making abnormal noise

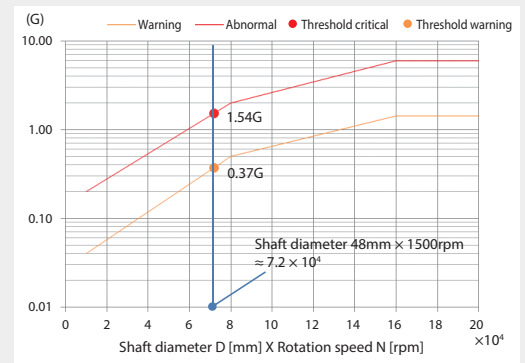

Threshold for this application (examples)

Example of Acceleration alarm threshold

Alarm threshold (Warning) **0.37G**

Alarm threshold (Critical) **1.54G**

Example of Velocity alarm threshold

Alarm threshold (Warning) **2.8mm/s**

Alarm threshold (Critical) **7.1mm/s**

Rms value of vibration velocity	Small-sized machines/ motor with output less than 15 kW	Medium-sized machine motor with output of 15 kW to 75 kW	Large-sized machines: machine installed on a heavy foundation with high rigidity.	Large-sized machines: machine installed on a foundation with soft rigidity.	Judgement
0.71mm/s	A	A	A	A	Normal
1.12mm/s	B	B	A	A	
1.80mm/s	C	Threshold warning C	B	B	
2.80mm/s	D	Threshold warning D	C	B	Warning
4.50mm/s		D	D	C	
7.10mm/s				D	D
11.20mm/s					
18.00mm/s					

Expected implementation effects

Enables remote detection of motor failure.

Detects degradation of bearings so users can replace them before they lock up.



II. Fan system application

Vibration/Temperature monitoring type

K6CM Target Application

Fan motors for air handling units

Facility details

Air conditioner that sets the temperature and humidity of the air to comfortable levels before sending it inside.

Motor operation conditions

22kW/200V/4poles
Inverter drive frequency: 50Hz

Failure mode

Deterioration over time

Detection parameters

Acceleration

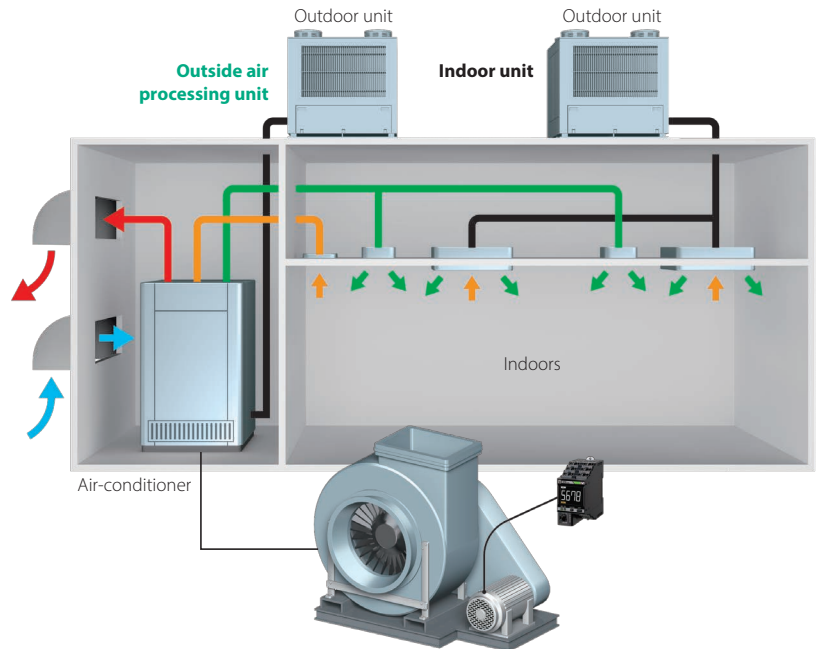

Acceleration measurement results obtained from K6CM-VBM

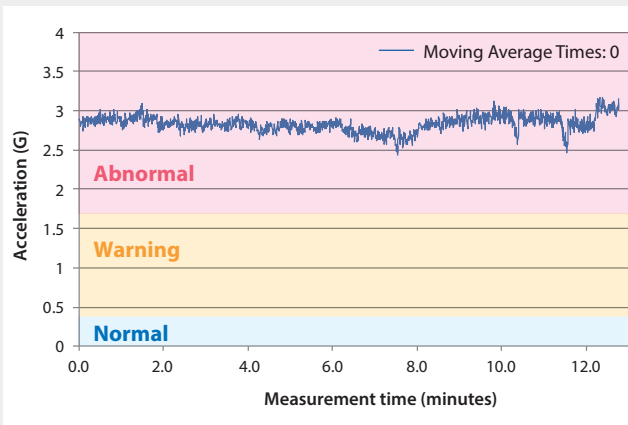

Measurement value under abnormal operation: **2.84G**
motor making abnormal noise

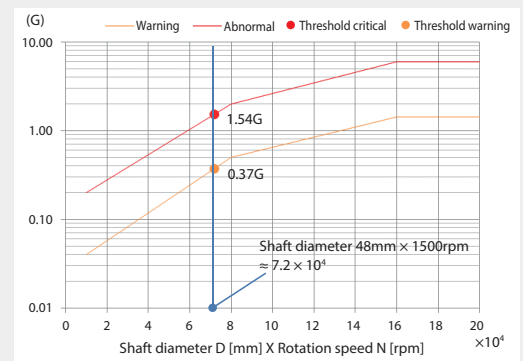

Alarm threshold acceleration for this application (examples)

Alarm threshold (Warning) **0.37G**

Alarm threshold (Critical) **1.54G**

Expected implementation effects

Enables remote detection of motor failure.

Detects degradation of bearings so users can replace them before they lock up.



II. Fan system application

Comprehensive current diagnosis type

Vibration/Temperature monitoring type

K6CM Target Application Cooling tower fans

Facility details

Cools cooling water sent to production facilities.
If temperatures rise during the day, fans are turned on to cool the fins, which in turn cool the cooling water.

Motor operation conditions

5.5kW/200V/4poles
Driving the motor by direct connection to commercial power supply: 60Hz

Failure mode

Deterioration over time

Detection parameters

Degradation level, Acceleration



Degradation level 1 measurement results obtained from K6CM-CI□

The current waveform data

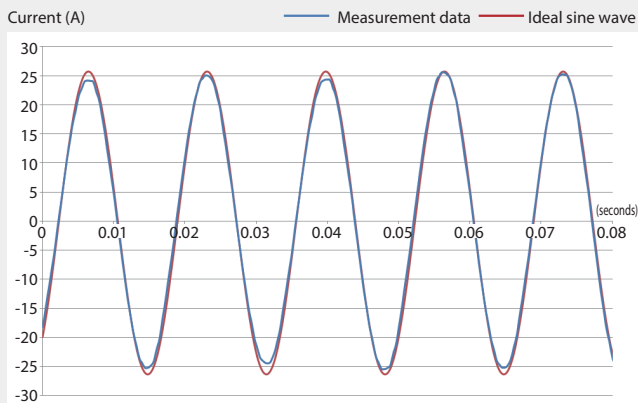

Normal Condition

Unit 2 **Measurement value under normal operation 29**
After maintenance

Unit 1 **Measurement value under normal operation 32**
After maintenance

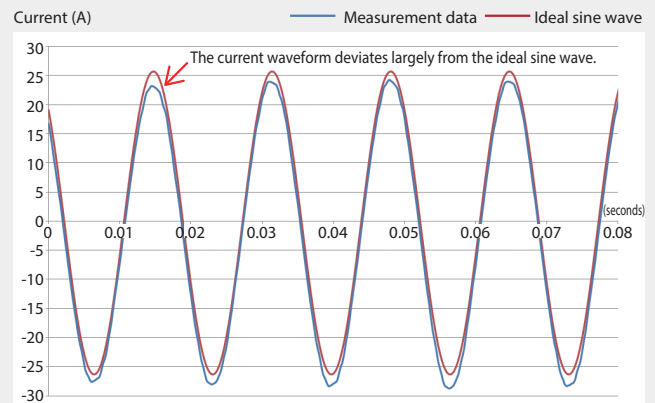

Abnormal Condition

Unit 2 **Measurement value under abnormal operation 71**
Before maintenance

Unit 1 **Measurement value under abnormal operation 44**
Before maintenance

Alarm threshold degradation level 1 for this application (examples)

Alarm threshold (Warning) 40

Alarm threshold (Critical) 50

Expected implementation effects

Enables the user to assess the right timing for maintenance based on the degree of deterioration instead of elapsed time.
Automatically notifies the user when to perform maintenance.

Acceleration measurement results obtained from K6CM-VBM



Unit1 Acceleration measurement results obtained from K6CM-VBM

Before maintenance

Measurement value under normal operation **0.25G**

After maintenance

Measurement value under normal operation **0.11G**

Unit2 Acceleration measurement results obtained from K6CM-VBM

Before maintenance

Measurement value under warning operation **0.44G**

After maintenance

Measurement value under normal operation **0.08G**

Regularly replace pulleys, bearings, belts, etc.

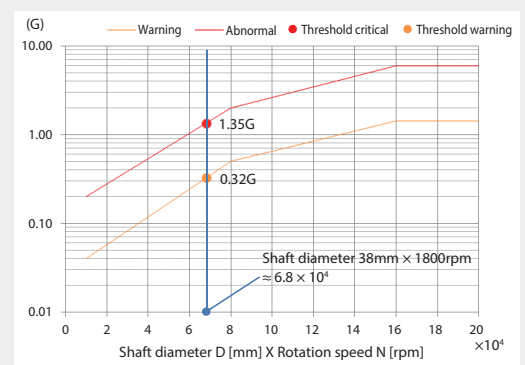
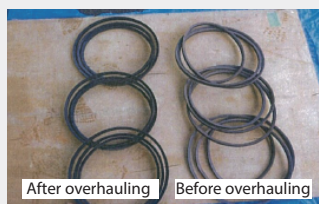
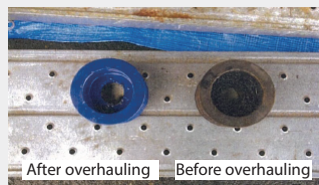
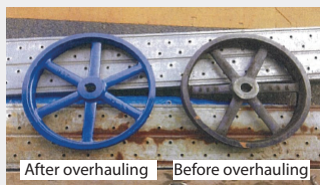

Note: Bearing anomalies can be detected earlier by vibration than by comprehensive current diagnosis. Load anomalies that cause bearing anomalies, however, are better detected using comprehensive current diagnosis.

Alarm threshold acceleration for this application (examples)

Alarm threshold (Warning) 0.32G

Alarm threshold (Critical) 1.35G

Expected implementation effects

Detects degradation of bearings so users can replace them before they lock up.



II. Fan system application

Comprehensive current diagnosis type

K6CM Target Application Heat exhaust fan

Facility details

Fan for exhausting heat generated from indoors facilities to the outdoors

Motor operation conditions

2.2kW/200V/4 poles
Direct connection to commercial power supply: 60Hz

Failure mode

Pulley wear
(V-belt slips; abnormal noise)

Detection parameters

Degradation level 1, 2

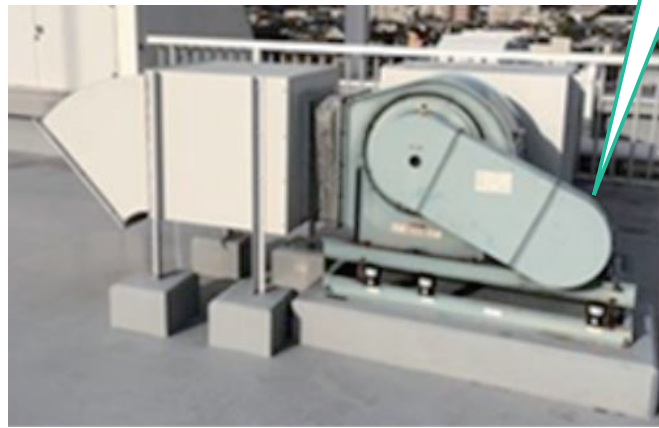

Degradation level 1,2 measurement results obtained from K6CM-CI□

Degradation level 1 log data

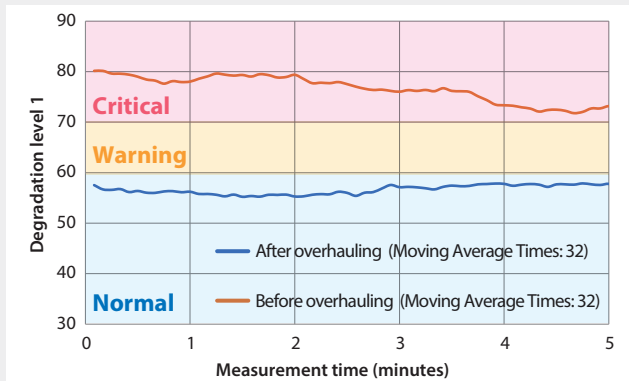

Measurement value under abnormal operation: **75**

Measurement value under normal operation: **57**

Degradation level 2 log data

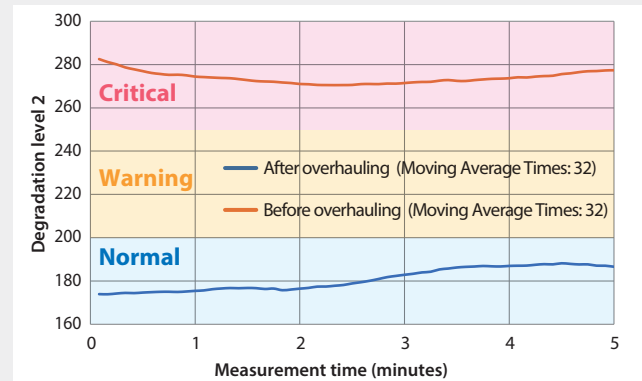

Measurement value under abnormal operation: **275**

Measurement value under normal operation: **180**

Alarm threshold degradation level 1,2 for this application (examples)

Example of degradation level 1 alarm threshold

Alarm threshold (Warning)	60
Alarm threshold (Critical)	70

Example of degradation level 2 alarm threshold

Alarm threshold (Warning)	200
Alarm threshold (Critical)	250

Degradation level 1 measurement results obtained from K6CM-CI2M

Before overhauling



Belt and pulley worn down by friction

After overhauling



Correct positioning of belt and pulley

Current waveform data over 4 seconds

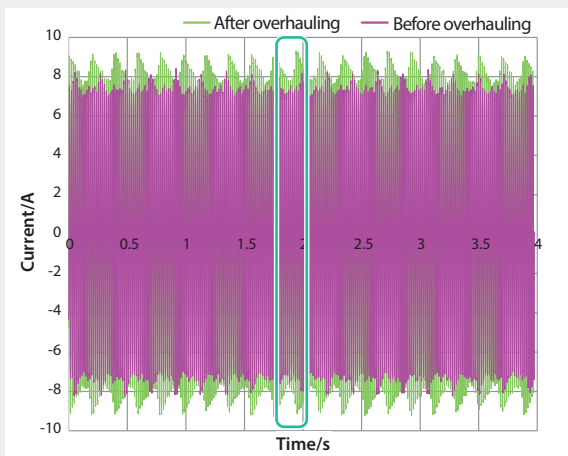

Zoom

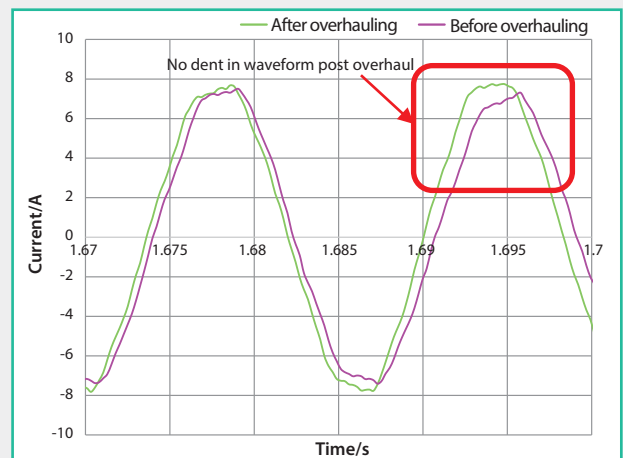

Expected implementation effects

Detects the degradations in V-belts, pulleys and automatically notifies the user when to perform maintenance.



II. Fan system application

Vibration/Temperature monitoring type

K6CM Target Application

Pressure adjustment blower

Facility details

Blower for adjusting pressure within a storage tank

Motor operation conditions

3.4kW/200V/2 poles
Inverter drive frequency : 65Hz

Failure mode

Deterioration over time

Detection parameters

Acceleration/Velocity

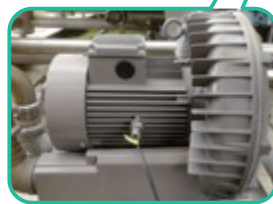
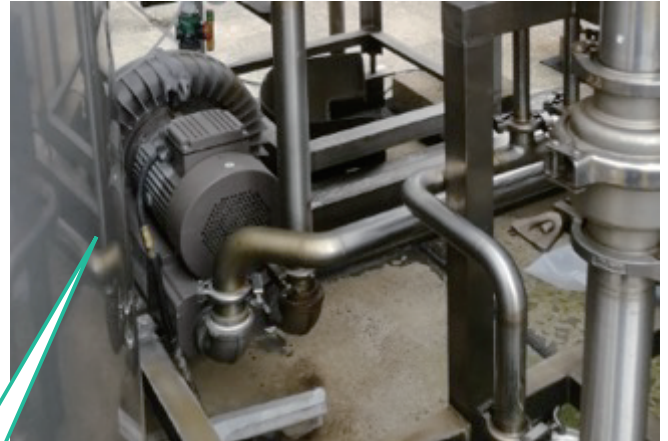

Fan system

Acceleration/Velocity measurement results obtained from K6CM-VBM

Acceleration measurement results

Measurement value under normal operation:

0.79G

Newly installed blower

Measurement value under warning operation:

0.96G

Blower installed after 6 years

Velocity measurement results

Measurement value under normal operation:

1.18mm/s

Newly installed blower

Measurement value under normal operation:

1.70mm/s

Blower installed after 6 years

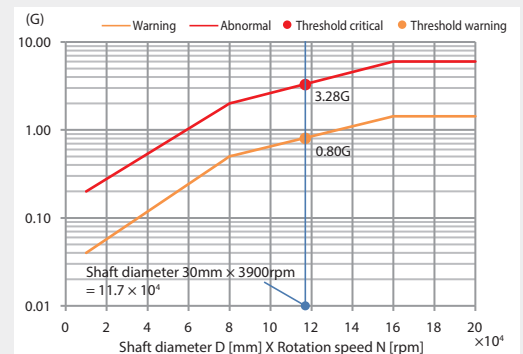
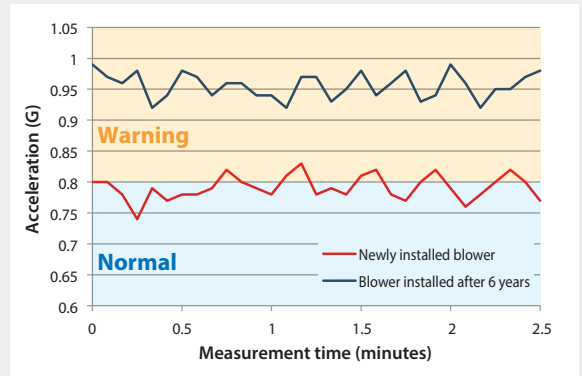

Threshold for this application (examples)

Example of Acceleration alarm threshold

Alarm threshold (Warning) **0.80G**

Alarm threshold (Critical) **3.28G**

Example of Velocity alarm threshold

Alarm threshold (Warning) **1.8mm/s**

Alarm threshold (Critical) **4.5mm/s**

Expected implementation effects

Enables remote detection of motor failure.

Detects the degradation of the bearings and fan blades, so the user can replace them before they lockup and fail.

K6CM Target Application Conveyor system

Facility details

Elevating device powered by a single motor that carries luggage, etc. up and down.

Motor operation conditions

5.5kW/200V/4poles
Driving the motor by direct connection to commercial power supply: 50Hz

Failure mode

Load abnormality

Detection parameters

Degradation level 1

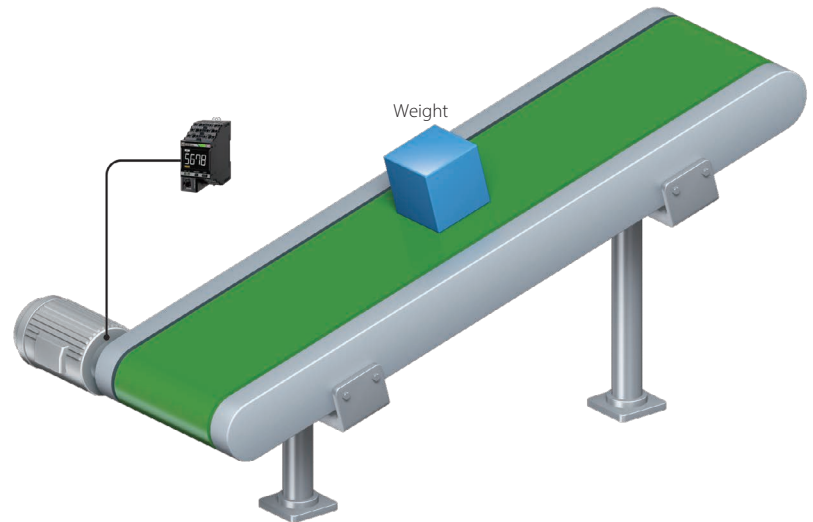

Transport system

Degradation level 1 measurement results obtained from K6CM-CI□

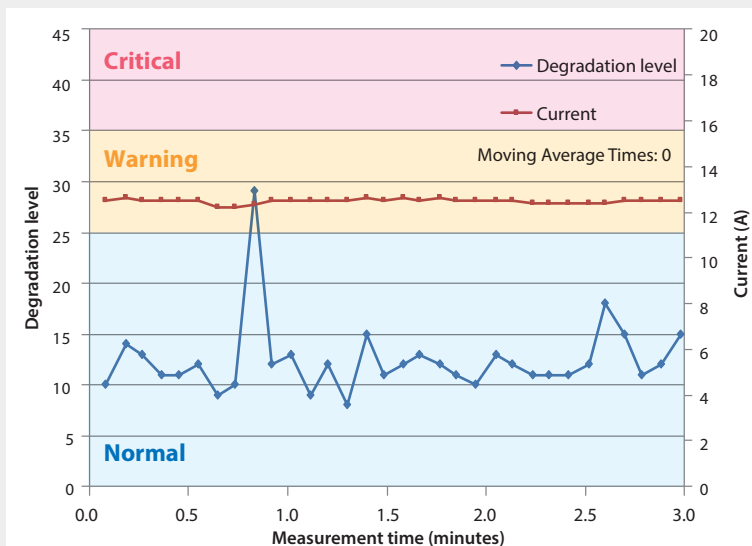

Measurement value under critical operation

29

With weight mounted

Measurement value under normal operation

12

Without weight mounted (average value)

Alarm threshold degradation level 1 for this application (examples)

Alarm threshold (Warning) 25

Alarm threshold (Critical) 35

Expected implementation effects

Prevents degradation by detecting anomalies that are not evident in electric current values.

Also detects load anomalies, e.g. when weight is too heavy.

K6CM Target Application Transport conveyor

Facility details

Conveyor for transporting completed products, which use belts that are powered by motors carrying products to their shipment sites.

Motor operation conditions

0.75kW/200V/4 poles
Direct connection to commercial power supply: 60Hz

Failure mode

Foreign object caught in the conveyor belt's mechanism

Detection parameters

Degradation level 1

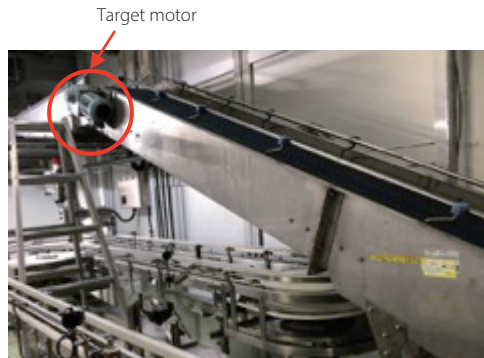

Degradation level 1 measurement results obtained from K6CM-CI□

Degradation level 1 measurement results

Measurement value under normal operation: **4**

Conveyor is transporting products

Current waveform data over 4 seconds

Measurement value under abnormal operation: **25**

Belt cannot move along smoothly because a foreign object has been caught in its mechanism

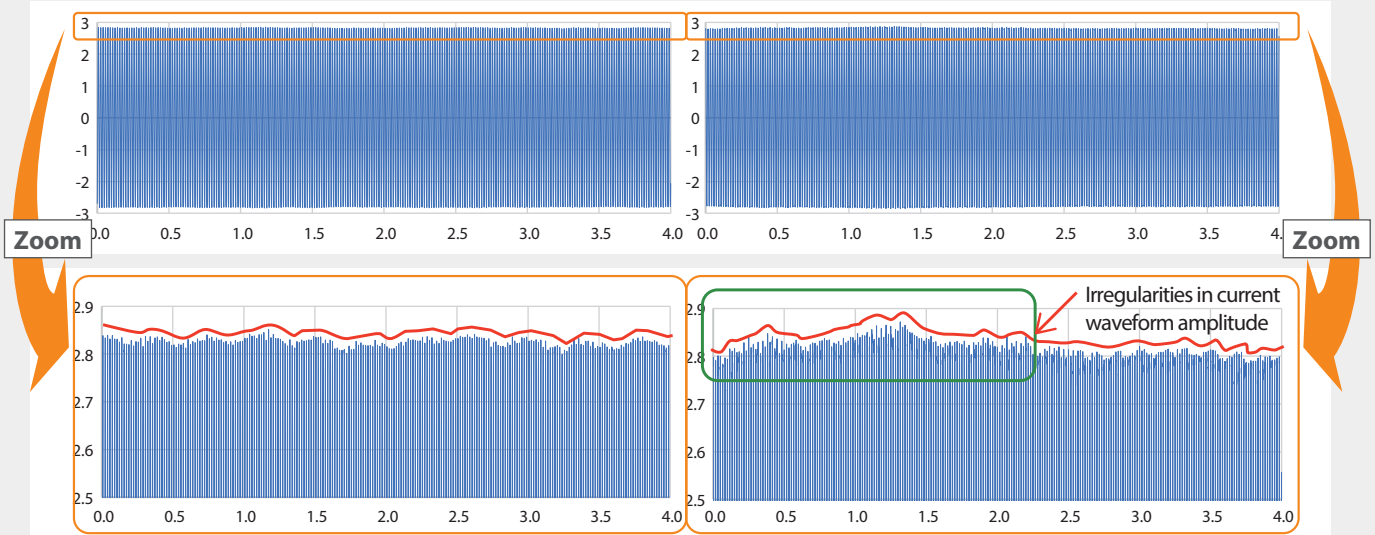

Normal Condition

Abnormal Condition

Alarm threshold degradation level 1 for this application (examples)

Alarm threshold (Warning) **10**

Alarm threshold (Critical) **20**

Expected implementation effects

Enables users to repair/replace conveyor before it stops due to deterioration, a foreign object attached on the back side of its belt, etc.

K6CM Target Application

Dryers (for spray-drying powders)

Facility details

Air is sprayed while the air injection pipe is rotated by a motor to prevent powder from accumulating on the inner wall of the conical drum. Rollers are installed along the inner wall of the conical drum.

Motor operation conditions

1.5kW/200V/4 poles
Direct connection to commercial power supply: 50Hz

Failure mode

Load abnormality

Detection parameters

Degradation level 1

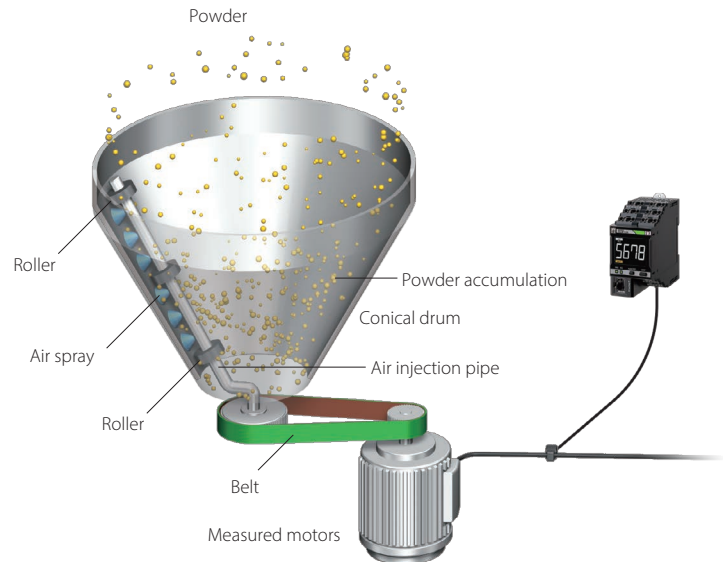

Degradation level 1 measurement results obtained from K6CM-CI

Current waveform data

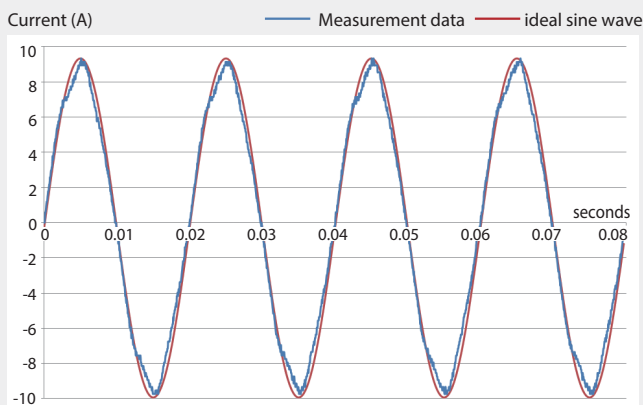

Normal Condition

Value for a normal working motor: **21**

Roller is rotating normally

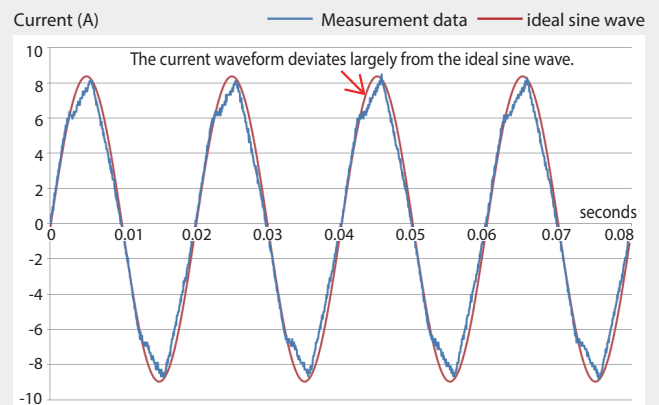

Abnormal Condition

Value for motor not working normally: **32**

Roller is not rotating due to powder lodged in its mechanism

Alarm threshold degradation level 1 for this application (examples)

Alarm threshold (Warning) **25**

Alarm threshold (Critical) **30**

Expected implementation effects

When the guide roller's diameter decreases due to wear, the contact area between the roller and the dryer wall decreases as well, causing the air injection pipe to oscillate significantly. This increases the load on the pipe and the dryer axis, which in turn can lead to damage. K6CM series products can prevent such problems from happening.

K6CM Target Application

Homogenizers

Facility details

Device that mixes and stirs a liquid (such as milk) into a consistent emulsion so it does not separate.

Motor operation conditions

90kW/200V
Driving the motor by direct connection to commercial power supply: 50Hz

Failure mode

Load abnormality (Piston rubber gasket deterioration)

Detection parameters

Degradation level 1

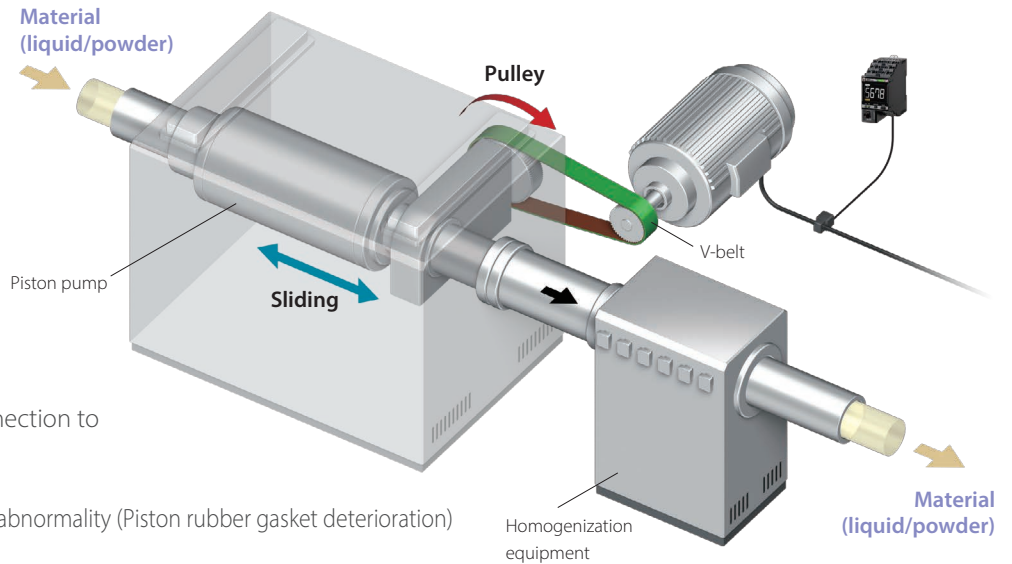

Degradation level 1 measurement results obtained from K6CM-CI□

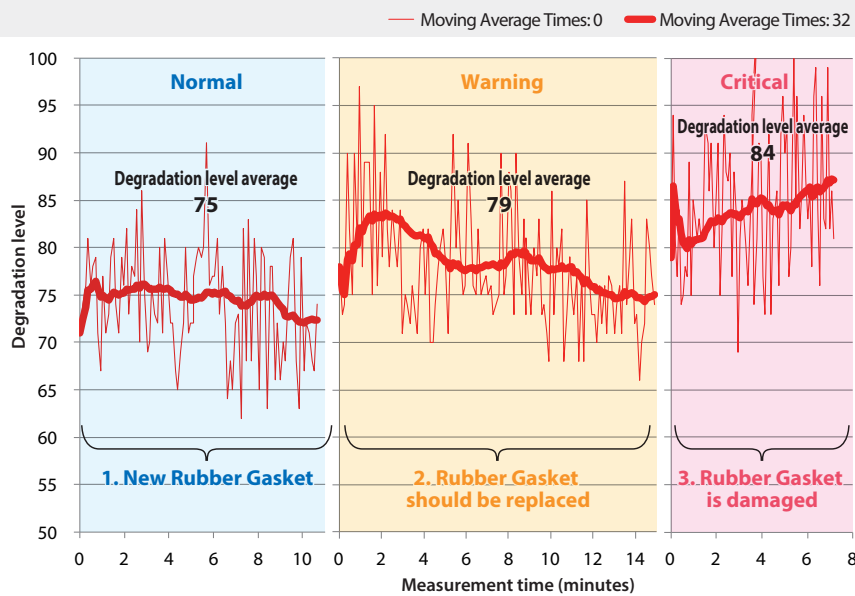

1. Value for a normal working motor:

74

New Rubber Gasket

2. Value for motor whose operation requires caution:

79

Rubber Gasket should be replaced

3. Value for motor not working normally:

84

Rubber Gasket is damaged

Alarm threshold degradation level 1 for this application (examples)

Alarm threshold (Warning) **77**

Alarm threshold (Critical) **85**

Expected implementation effects

Enables early detection of facility anomalies to reduce production loss.
Improves production quality by detecting facility anomalies.

K6CM Target Application Storage tank mixer

Facility details

Equipment for mixing storage tank content

Motor operation conditions

0.4kW/200V/4 poles
Direct connection to commercial power supply: 60Hz

Failure mode

Mixing blade not securely fixed in place

Detection parameters

Degradation level 1, 2

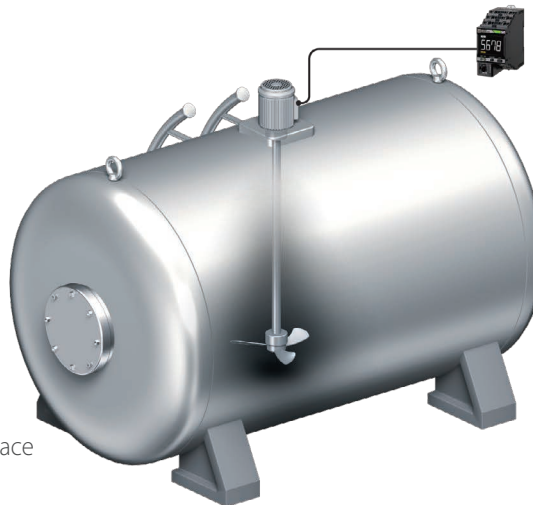

Degradation level 1,2 measurement results obtained from K6CM-CI2M

Degradation level 1 measurement results

Measurement value
under warning operation:

36

Axial deviation

Measurement value
under abnormal operation:

42

Blade has fallen to the tank bottom
(axial deviation loosened its
fastening screws)

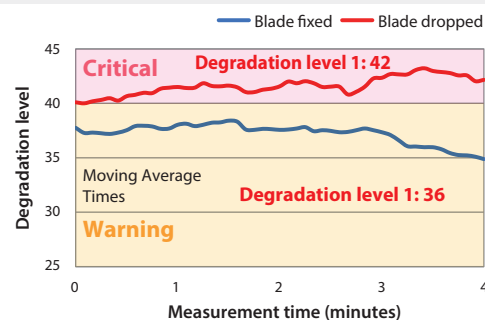

Degradation level 2 measurement results

Measurement value
under warning operation:

34

Axial deviation

Measurement value
under abnormal operation:

92

Blade has fallen to the tank bottom
(axial deviation loosened its
fastening screws)

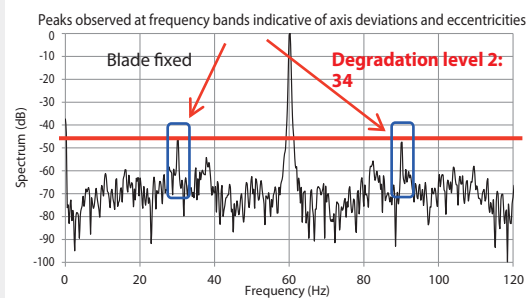

Alarm threshold degradation level 1,2 for this application (examples)

Example of degradation level 1 alarm threshold

Alarm threshold (Warning) 25

Alarm threshold (Critical) 40

Example of degradation level 2 alarm threshold

Alarm threshold (Warning) 20

Alarm threshold (Critical) 50

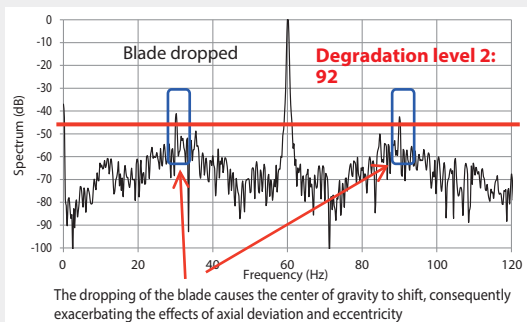

Expected implementation effects

Enables the detection of anomalies and load changes in parts of the axis that are far from the motor.

K6CM Target Application

Can seamer

Facility details

Device for binding lids on cans (e.g. drink cans)

Motor operation conditions

30kW/400V/4 poles

Inverter drive frequency: 60Hz

Rotation speed: 1800rpm

Failure mode

Creep phenomenon

Detection parameters

Degradation level 1

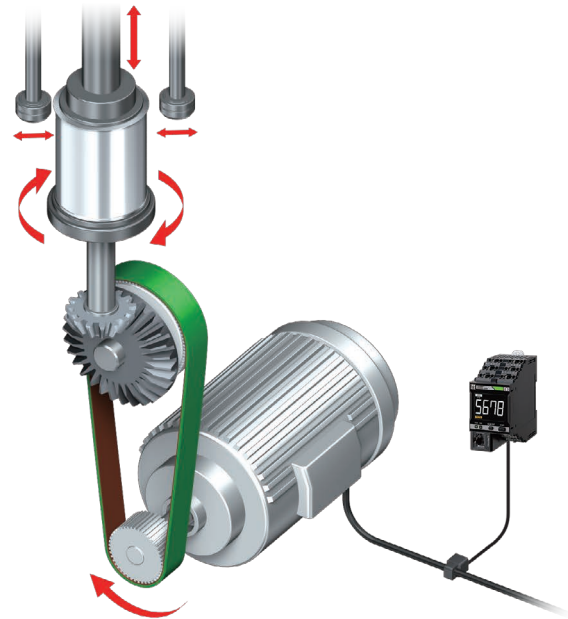

Degradation level 1 measurement results obtained from K6CM-CI□

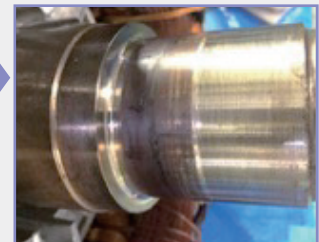
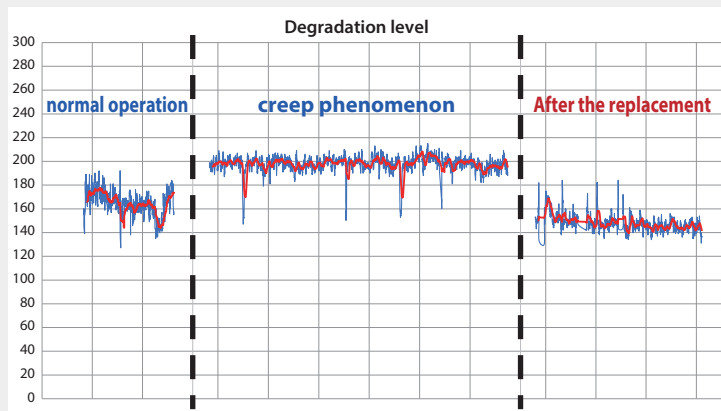

Measurement value under normal operation: **148**

After bearing, bearing case and shaft being replaced

Measurement value under abnormal operation: **198**

With creep phenomenon

Alarm threshold degradation level 1 for this application (examples)

Alarm threshold (Warning) 180

Alarm threshold (Critical) 195

Expected implementation effects

The creep phenomenon may be caused by the following, and if left unaddressed, can lead to major problems. K6CM series products can prevent such problems from happening.

- Abnormal rise in temperature
- Excessive load
- Insufficient interference where parts are engaged

OMRON Corporation Industrial Automation Company

Kyoto, JAPAN

Contact: www.ia.omron.com

Regional Headquarters

OMRON EUROPE B.V.

Wegalaan 67-69, 2132 JD Hoofddorp
The Netherlands
Tel: (31)2356-81-300/Fax: (31)2356-81-388

OMRON ELECTRONICS LLC

2895 Greenspoint Parkway, Suite 200
Hoffman Estates, IL 60169 U.S.A.
Tel: (1) 847-843-7900/Fax: (1) 847-843-7787

OMRON ASIA PACIFIC PTE. LTD.

No. 438A Alexandra Road # 05-05/08 (Lobby 2),
Alexandra Technopark,
Singapore 119967
Tel: (65) 6835-3011/Fax: (65) 6835-2711

OMRON (CHINA) CO., LTD.

Room 2211, Bank of China Tower,
200 Yin Cheng Zhong Road,
PuDong New Area, Shanghai, 200120, China
Tel: (86) 21-5037-2222/Fax: (86) 21-5037-2200

Authorized Distributor:

© OMRON Corporation 2019-2020 All Rights Reserved.
In the interest of product improvement,
specifications are subject to change without notice.

Cat. No. N223-E1-02

0420 (1019)