

Remote condition monitoring of critical equipment

<Vol.1> Technology that helps reduce unplanned downtime and operational costs



INDEX

- Predictive Maintenance Solutions	P 2
- Applications	P 4
- TOPICS Technologies	P 8
- Special Feature Maintenance Tips	P 10



Omron's Predictive Maintenance Solutions

Predictive maintenance is the key to reducing unplanned downtime and operational costs

Due to large shifts in business conditions there is an urgent need to transform the workplace by overcoming the dependence of skilled maintenance personnel and using the latest technology as a primary solution. Overcoming cost and technological barriers can be difficult. Omron's solution monitors and analyzes real data by performing frequent checks.

Predictive Maintenance- take action when necessary

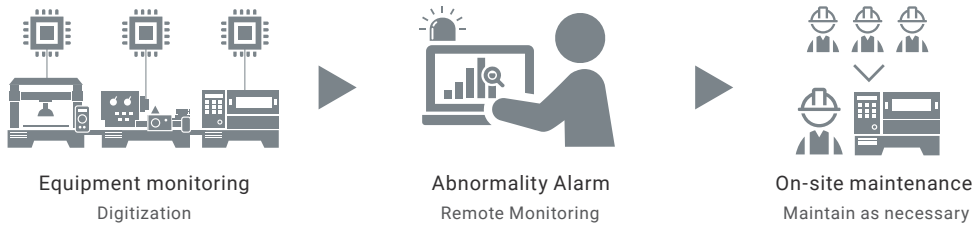

Remote monitoring of critical equipment using condition monitoring devices

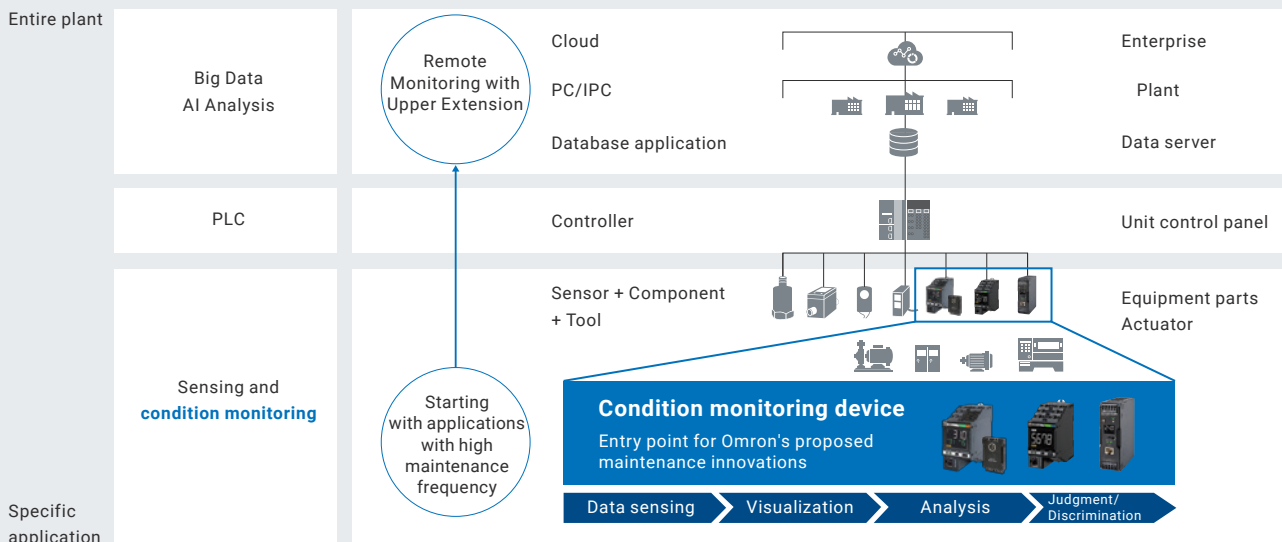

Resolve issues through condition monitoring

Our predictive maintenance solution is based on replicating skilled maintenance engineer's analysis, retrofitting existing equipment and remote monitoring. The technology simplifies the analysis of equipment by translating measurement data into simple alarms so a maintenance engineer can respond faster to issues.

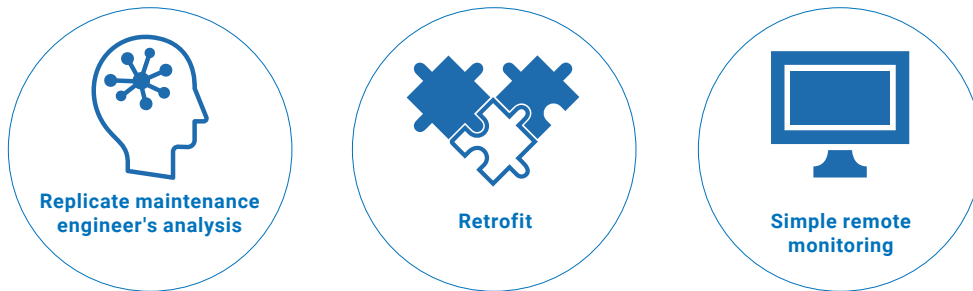

Three Values of Omron's Condition Monitoring

How condition monitoring works

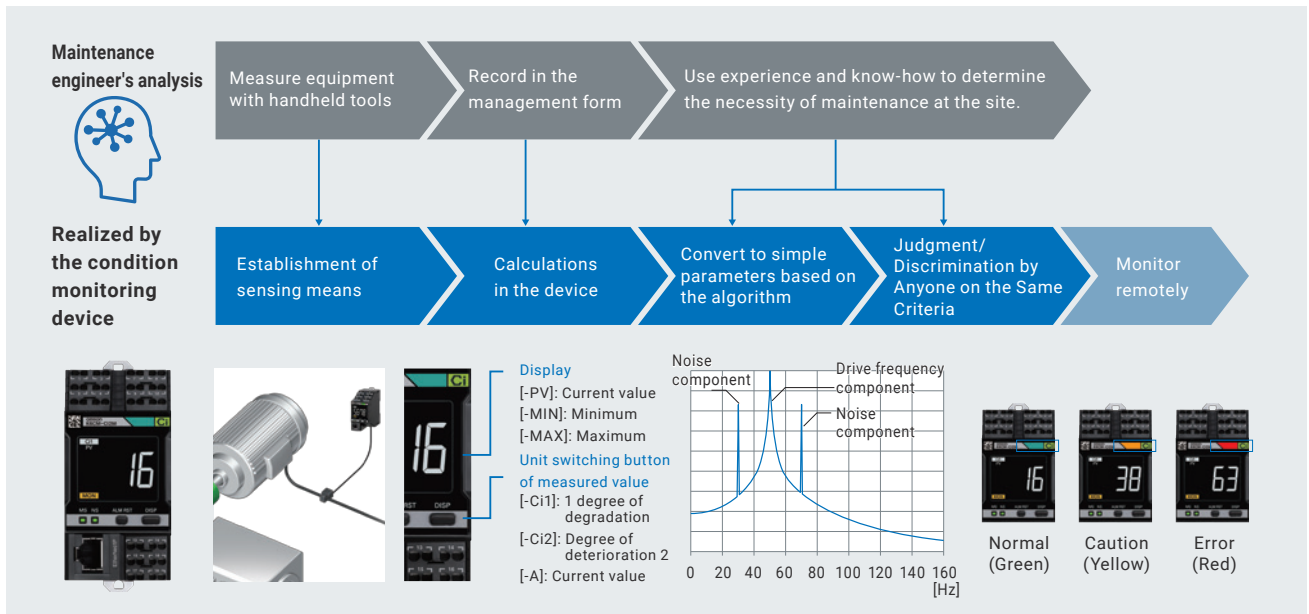

Easily installs on existing equipment

Omron's predictive maintenance solutions are easy to install into existing equipment and requires little to no modification.

Introduced in Vol. 2

Remote monitoring made simple

Each predictive maintenance solution comes equipped with a software tool which provides simple monitoring information for easy operation. Analysis is performed by the controller so no manual analysis is necessary.

Introduced in Vol. 3

Predictive Maintenance Applications

Detecting worn components on homogenizer

K6CM motor condition monitoring device

Effect: Eliminates maintenance and inspection services essential for stable production of beverages

Beverage manufacturers can occur huge losses due to equipment failure.

Worn components on homogenizers can lead to unplanned downtime and contaminated products.

Identifying component failures early was difficult due to the limited amount of experienced maintenance engineers.

As a result, the maintenance crew replaced parts frequently to avoid unplanned downtime.

This maintenance strategy was not cost effective or efficient for the manufacturer.

By introducing the K6CM motor condition monitor, the maintenance engineers were able to monitor the condition of the homogenizer's component degradation and respond as necessary to issues.

This also reduced the replacement of unnecessary components and eliminated frequent inspections.

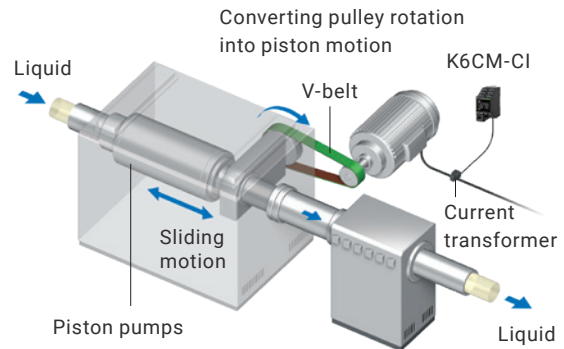

FROM

Manually checking motor current readings

The motor current was measured manually using a current meter. However, testing was not consistent and abnormalities could not be detected. Parts were replaced once every 3 to 6 months and overhaul was carried out once a year.



TO

Remote motor current distortion analysis

The equipment automatically checks the condition of component deterioration. By constantly monitoring the situation remotely, periodic inspections are no longer necessary, and it is now possible to simply replace parts in a planned manner.

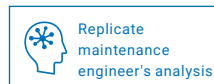
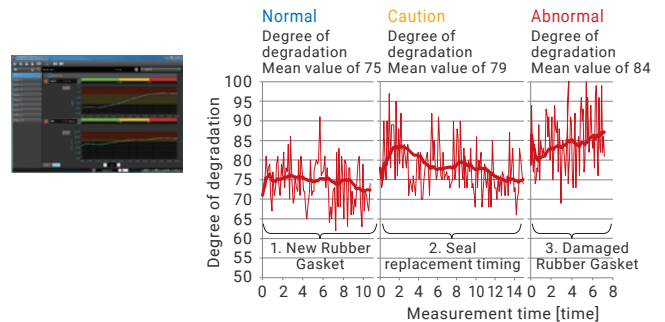

Abnormalities can be reliably identified by analyzing changes not seen with the current value using the current waveform to convert them to degrees of deterioration.

Customer Feedback



Beverage manufacturer

Maintenance Section Manager

Minimizing quality defects and strengthening safety and security

Detection of the deterioration of the Rubber Gasket prevented the quality defect of foreign matter. We intend to expand the system to other plants and verify it at other facilities as well.

Maintenance Section Technician

Systematic maintenance is achieved.

By knowing the timing of replacement in advance, planned maintenance is realized. The elimination of periodic replacement enabled the maintenance work to be streamlined. We would like to make further improvements, including the deployment to other facilities, using the time that has become more efficient.

Detecting cooling water circulation pump deterioration

K6CM motor condition monitoring device

Effect: Reduction in on-site maintenance inspections for cooling water circulation pumps.

A cooling water circulation pump in a water treatment plant typically runs 24-hours of continuous operation. If a failure of a cooling water circulation pump occurs, the plant can experience a large loss in production. Since the equipment runs continuously, it was very difficult to inspect for failures without shutting the machine down. Inspections were carried out manually by an experienced maintenance engineer using vibration testers and basic tools.

By installing the K6CM, it was possible to predict the rate of the pump deterioration without the need of shutting down the equipment. As a result, the customer eliminated the need for manual inspections while getting more accurate and consistent data from the pump.



FROM

Periodic on-site inspection by a maintenance engineer using a vibration tester.

Periodic inspections were carried out because it was unclear when it would break, but there were cases in which a failure occurred between inspections.



TO

Remote monitoring of abnormal vibration conditions and receiving alerts of degradation.

K6CM can detect the deterioration tendency from a remote location and realize central monitoring. The maintenance man-hours were greatly reduced by maintaining them when necessary.

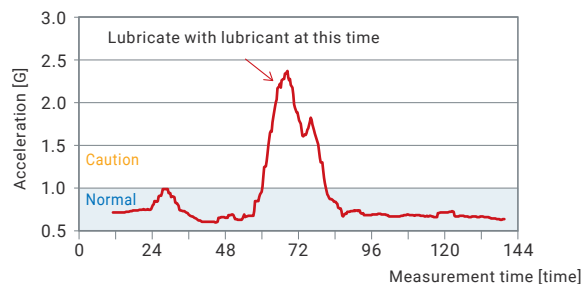

High-frequency vibrations are accurately measured and converted to speeds and accelerations for early detection of abnormal conditions.

Customer Feedback

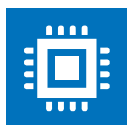

Semiconductor manufacturer

Maintenance Section Manager

Visualization of abnormalities to solve problems in inheritance of technologies

Other company's vibration sensor was also examined, but no abnormality was found. K6CM was able to accurately identify abnormalities and represent them numerically, enabling new employees to judge abnormalities and solve problems in the transmission of technologies.

Maintenance Section Technician

Remote monitoring does not require walkdown.

In order to check the motor status, they went to the site periodically and checked the status. However, by installing K6CM, there was no need for Company A to go to the site, and by remotely checking the data, they saved manpower.

Predictive Maintenance Applications

Detecting hydraulic valve wear on a stamping press

K6PM-TH thermal condition monitoring device

Effect: Faster response to hot spots developing in hydraulic system

A global automotive manufacturer experienced a hydraulic valve failure on their stamping press due to contamination in the hydraulics. This caused significant unplanned downtime for the plant since it is used to stamp body panels. Over time foreign debris enters the hydraulic system and is often detected by an increase in surface temperature of the hydraulic valves. The maintenance engineer manually checked the temperature of the valves but was unable to catch the problem due to the lack of continuous monitoring. The K6PM thermal condition monitor was installed to detect the surface temperature of the hydraulic valves over time. The maintenance engineer is now able to receive alerts of increased hydraulic valve surface temperatures and respond faster to issues. Also, the maintenance engineer is no longer required to do routine temperature checks.

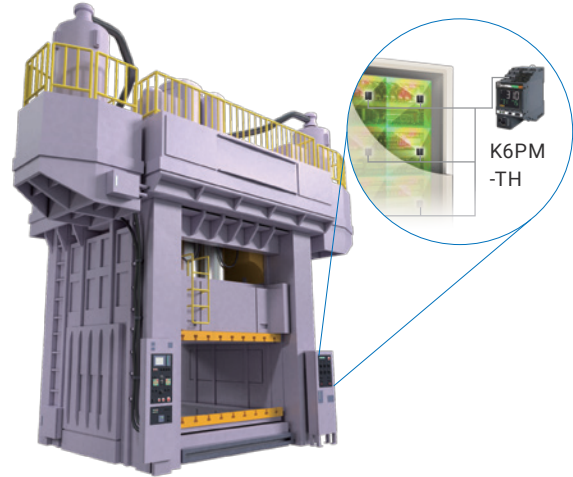

FROM

Manual thermal inspection of hydraulic temperatures on stamping press

Since few manual thermal inspections were performed, it was difficult to identify trends and intermittent hot spots. This led to premature failure of the hydraulic valve.



TO

Continuous monitoring of hydraulic valve temperature using K6PM's thermal image sensors

Instead of relying on a manual thermal inspection to identify hydraulic valve temperature increases, the maintenance engineers can remotely monitor the changes of equipment overtime and respond faster to issues more reliably.

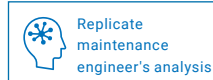

Both ambient temperature and measurement temperature are simultaneously detected, and the pure temperature change of the measurement object is monitored (differential temperature detection algorithm).

Customer Feedback



Automotive manufacturer

Maintenance Section Leader

Contributing to the planned maintenance of press machines

If the press stops due to a failure, the equipment can be used for several weeks until recovery. In the meantime, production was transferred to another press machine, but production could not be done immediately due to equipment adjustment at the transfer destination. The K6PM is always monitored to show the change before the failure, which makes it easier to predict the timing of maintenance and contributes to the planned maintenance.

Maintenance Section Technician

Check the valve condition efficiently.

Temperature inspection of the hydraulic valve was carried out when the worker entered the site. However, a large press requires a lot of inspection work. The K6PM can be constantly monitored and the threshold can be set. Therefore, the deterioration of the valves can be seen from the office, and the man-hours for maintenance can be reduced.

Detecting control panel abnormalities using IoT

S8VK-X IoT power supply

Effects: Remote monitoring of automotive production line equipment for improved predictive maintenance

Automotive assembly and production facilities are often large operations that run at very high duty cycles.

It's very common to see hundreds of control panels installed to power the equipment. Identifying issues in a control panel is challenging for a maintenance engineer due to the amount of manual inspection required.

Manually checking circuits with a handheld meter made it difficult to detect the deterioration of the components in the panel.

In order to prevent unplanned downtime, the maintenance engineer would proactively replace control panel components to reduce risk of failure. With the S8VK-X power supply installed in the control panel, the maintenance engineer can visualize the health of the power supply along with circuit information downstream of the power supply.

This improves predictive maintenance and eliminates unnecessary replacement of components.

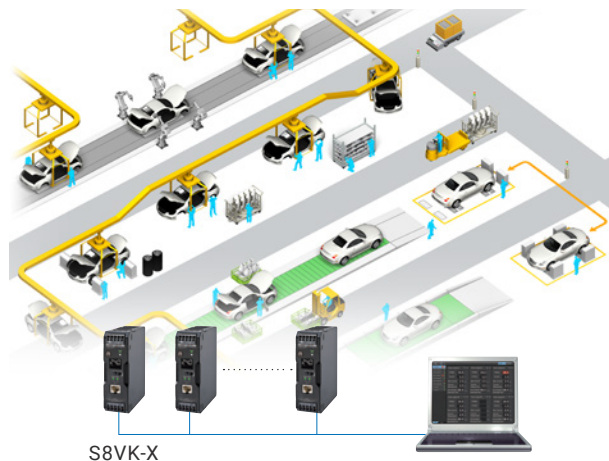

FROM

Manual inspection of control panel and unnecessary replacement of components

The power supply is an important component of the production facility because it supplies electricity to most control components, and must be replaced before the end of its life. However, it is difficult to investigate the degree of deterioration, and it is difficult to determine the optimal replacement timing.



TO

Remote monitoring of equipment health and maximizing power supply life

The temperature of the installed electrolytic capacitor was measured, and S8VK-X predicted the replacement time. Since the data can be obtained by communication, the status of each S8VK-X can be grasped by centralized monitoring from the office.



Calculate the degree of deterioration of the life parts from the internal temperature and notify the replacement time.

Customer Feedback



Automotive manufacturer

Maintenance Section Manager

Efficiency improvement through office monitoring

We were able to monitor the power supply conditions at the site intensively in the office, and we were able to reduce the man-hours of maintenance members. By checking the data at the office, it became easier to plan for conservation, and the conservation efficiency and production efficiency increased.

Process facility maintenance section Technician

Maintenance planning based on the degree of deterioration

The power supply doubles or halves its life due to a temperature change of 10 °C, but it is difficult to measure the temperature one by one to determine the deterioration. The data for S8VK-X shows the status of the degradation determined for each product. Therefore, it is only necessary to use the data to formulate a conservation plan.

TOPICS

Omron's unique technology that eliminates the need for frequent inspections from maintenance personnel



Technology for motor condition monitoring

There are various cases of motor abnormalities such as bearing wear, insulation deterioration, misalignment with the equipment connected to the motor, and imbalance. To evaluate the condition of the motor, it required an experienced maintenance engineer to use vibration and temperature testing equipment.

With Omron's sensing technology, the K6CM can detect various abnormalities in the motor, analyze the failure mode, and notify the maintenance remotely through Ethernet IP or Modbus TCP

K6CM motor condition monitoring device



Motor failure mode

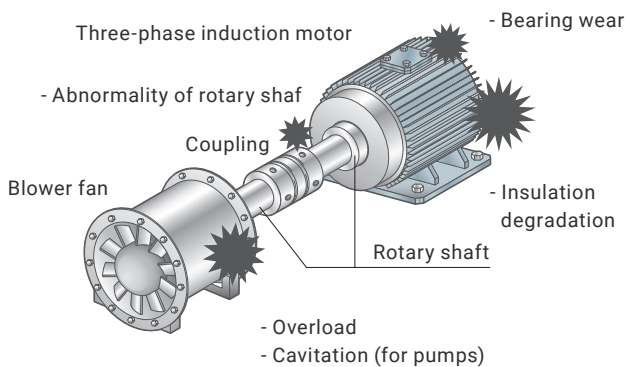

Normal rotation

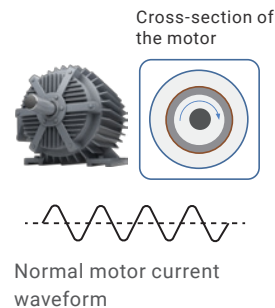

Rotation in the event of an error

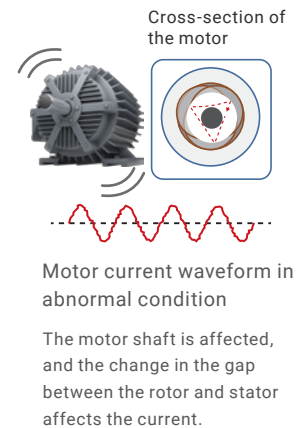

Degradation detection algorithm

The degree of deterioration is a numerical measure of the degree of deviation from the smooth sine wave, which is the ideal motor current state, for the obtained current waveform data as a whole by taking advantage of the property that abnormalities in the motor or connected equipment affect the motor current waveform. Abnormalities such as cavitation/air blowing of the pump and foreign matter intrusion in the conveying equipment can be detected.

By noticeably capturing and quantifying specific frequency components among the frequency components affecting the motor's rotational axis, it is effective for detecting errors such as misalignment and imbalance of the motor's rotational axis that occur regularly, and can detect abnormalities with high sensitivity even in an environment with inverter noise. This "degree of deterioration" value makes it easier to find out the abnormal condition of the motor that relied on the intuition, tips, and experience of the skilled person.

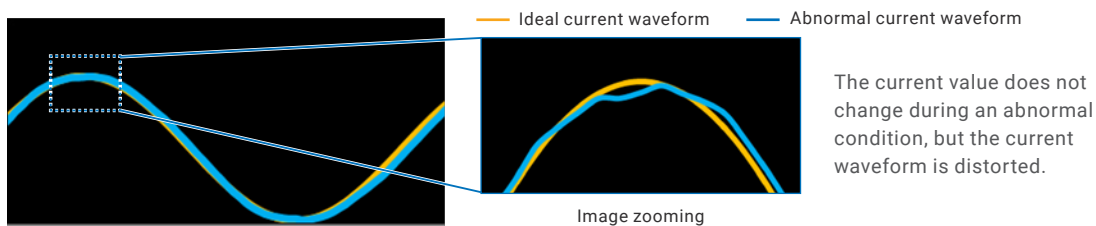

We have some K6CM video for easy to image real application, please ask Omron sales person.

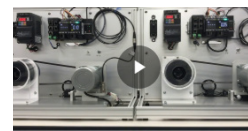
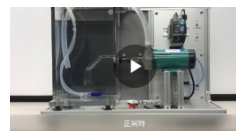



Detect hot spots remotely using thermal infrared sensors

Hot spots in control panels are caused by many factors such as overheating, insulation breakdown and loose connections. These hotspots can cause electrical fires and serious damage to the equipment.

The K6PM-TH thermal condition monitoring device provides continuous monitoring of hot spots of equipment and alerts the maintenance engineer of rising temperatures.

Conventional temperature monitoring methods

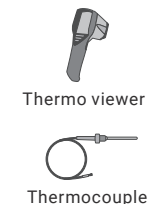

K6PM-TH thermal condition monitoring device



Arrival temperature prediction algorithm

On-site issues

The error may progress during the periodic inspection, delaying the detection of the error, and causing ignition, smoke generation, or stoppage of equipment. In addition, even if data are obtained at all times, there may be cases where there is not enough time to go to the site after the threshold is exceeded and the response is not in time.

Solution

The temperature to be reached is predicted from the tendency of the temperature to rise, and the abnormal temperature is judged early.

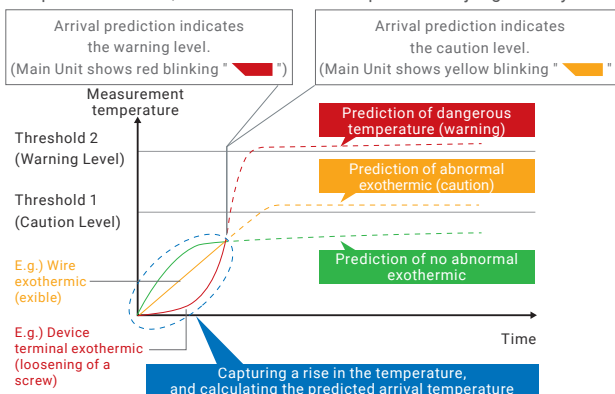

Differential temperature detection algorithm

On-site issues

Unable to calculate the accurate temperature variation of a device measured under an environment to be affected by an outside air temperature.

If the ambient temperature changes, the temperature of the equipment to be measured also changes significantly.

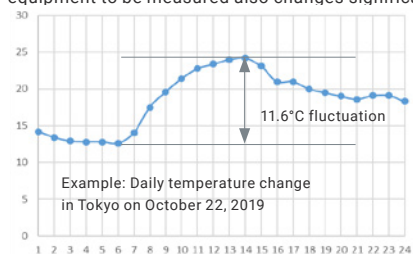

Source: Japan Meteorological Agency website

Solution

Measure ambient temperature inside the sensor.

Measuring the ambient temperature with the inside of the sensor, and constantly calculating the differential temperature from the device temperature. Capturing a temperature rise of the device properly, and determining the abnormality.

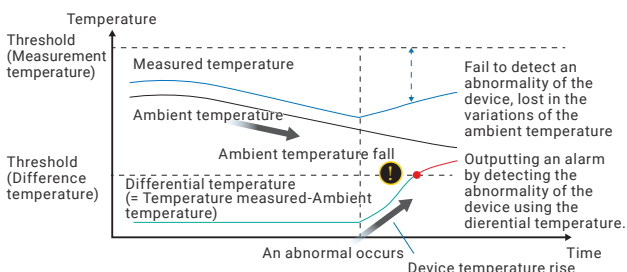

We have some K6PM video for easy to understand algorithm effect, please ask Omron sales person.

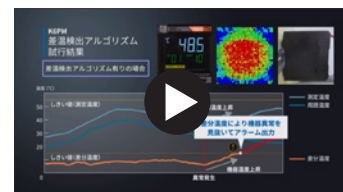
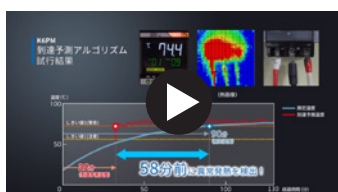

Special Feature Maintenance tips

Relays and Timers

Issue When the equipment was stopped suddenly, the relay and timer of the equipment in which the relay was installed were out of order.



Cause The appropriate relay timer for the load may not be selected.

In general, there are many cases in which "large is small" such as the capacity of personal computers and smartphones. However, the relays installed inside the timer and the monitoring relay must be selected for each load because the relay structure (contact mechanism, etc.) requires different requirements for high current and small current. In other words, relays are "large can be small." Proper selection improves the life of the relay and reduces contact defects, thereby improving the reliability of the relay circuit.

Differences in contact mechanism and examples of applications

Contactor	Tendency of loads to be constructed	Examples of applications	
<p>Double break contact</p>	<p>High-capacity load area Reference: more than 15A Note. AC 40A and DC 10A for relays</p>	<p>Compressor and heater open/close applications, motor open/close control applications, etc.</p>	<p>Large capacity</p> <p>↑</p> <p>↓</p> <p>Small capacity</p>
<p>Single contacts</p> <div style="display: flex; justify-content: space-around;"> <div style="text-align: center;"> Movable contact diagram </div> <div style="text-align: center;"> Fixed contact diagram </div> <div style="text-align: center;"> Contact image </div> </div>	<p>General area Reference: 0.05-15 A or less</p>	<p>Typical sequence circuit</p>	
<p>Bifurcated contacts</p> <div style="display: flex; justify-content: space-around;"> <div style="text-align: center;"> Movable contact diagram </div> <div style="text-align: center;"> Fixed contact diagram </div> <div style="text-align: center;"> Contact image </div> </div>	<p>Areas of microscopic load Guideline: Less than 0.05A</p>	<p>PLC inputs, signal applications, self-holding circuits, etc.</p>	
<p>Crossbar bifurcated contacts</p> <div style="display: flex; justify-content: space-around;"> <div style="text-align: center;"> Movable contact diagram </div> <div style="text-align: center;"> Fixed contact diagram </div> <div style="text-align: center;"> Contact image </div> </div>	<p>Estimated area of micro-load: less than 0.01A Note. Increase contact reliability by approaching line contact and increasing weight per area.</p>	<p>Alarm applications (infrequent applications)</p>	

Fixing up Choose products suitable for the load.

Recommended device by Omron

Miniature Power Relays MY

Can be selected from a broad lineup

- MY4 (Single contacts)
- MY4Z (Bifurcated contacts)
- MY4Z-CBG (Crossbar bifurcated contacts)

Solid-state Timers H3DT

Measuring and Monitoring relays

Issue If the monitoring relay is used in an environment where noise is severe, such as an inverter, it is likely to break quickly.

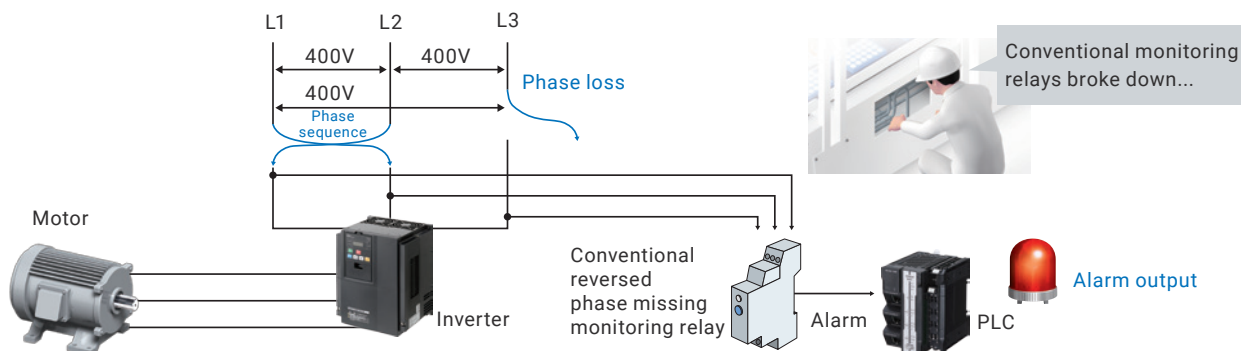

Cause Be due to the power supply circuit

Many of the monitoring relays use condenser droppers, and heat generation increases due to high frequency noise.

If the fever increases, the following risks may occur.

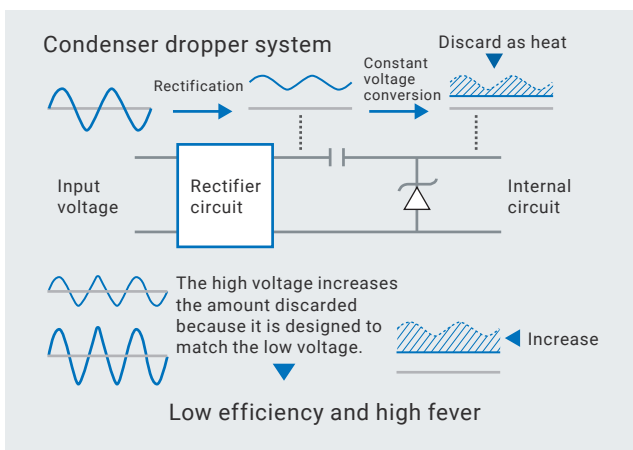

Physical failure
Abnormal heat generation due to high frequency noise leads to internal failure of the parts.

Electrical life
The internal heat generation increases and the life of the electrolytic capacitor decreases.

Commercially available monitoring relays

High heat generation increases the risk of failure of parts with short life.

Fixing up Select products with switching method.

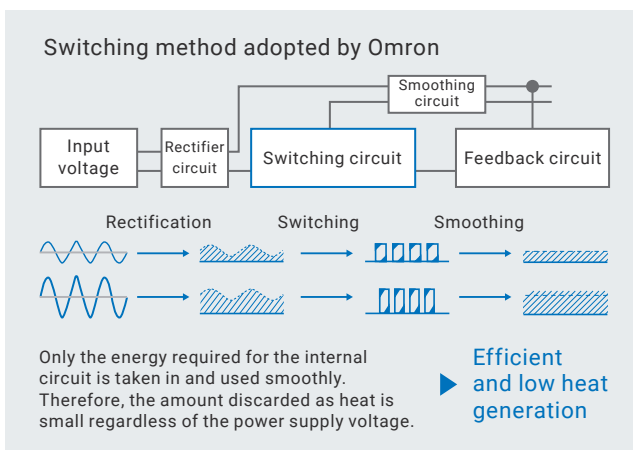

Recommended device by Omron

Measuring and Monitoring Relays K8DT

Switching method is adopted, and adhesive attachment is possible with low heat generation.

K8DT- AS K8DT- AW K8DT- VS K8DT- VW K8DT- PH K8DT- PM K8DT- PZ K8DT- TH K8DT- LS

Omron's Predictive Maintenance Solutions

If you have any requests or questions, please ask our sales person.

Motor Condition Monitoring Device K6CM



Thermal Condition Monitoring Device K6PM-TH



Motor Condition Monitoring Devices
K6CM series
Application Guide

Cat. No. N223-E1

IoT Power Supply S8VK-X



EtherNet/IP™ is a trademark of ODVA.

Modbus is a registered trademark or trademark of SchneiderElectricUSA Inc. in Japan, the United States or other countries.

The names of companies and products listed in this document are trademarks or registered trademarks of their respective companies.

Screenshot is used with Microsoft's permission.

Note: Do not use this document to operate the Unit.

OMRON Corporation Industrial Automation Company
Kyoto, JAPAN

Contact: www.ia.omron.com

Regional Headquarters

OMRON EUROPE B.V.
Wegalaan 67-69, 2132 JD Hoofddorp
The Netherlands
Tel: (31)2356-81-300/Fax: (31)2356-81-388

OMRON ASIA PACIFIC PTE. LTD.
No. 438A Alexandra Road # 05-05/08 (Lobby 2),
Alexandra Technopark,
Singapore 119967
Tel: (65) 6835-3011/Fax: (65) 6835-2711

OMRON ELECTRONICS LLC
2895 Greenspoint Parkway, Suite 200
Hoffman Estates, IL 60169 U.S.A.
Tel: (1) 847-843-7900/Fax: (1) 847-843-7787

OMRON (CHINA) CO., LTD.
Room 2211, Bank of China Tower,
200 Yin Cheng Zhong Road,
PuDong New Area, Shanghai, 200120, China
Tel: (86) 21-5037-2222/Fax: (86) 21-5037-2200

Authorized Distributor:

© OMRON Corporation 2020 All Rights Reserved.
In the interest of product improvement,
specifications are subject to change without notice.

Cat. No. Y236-E1-02

1020 (0820)